



Operation Manual

intelligent touch Controller



Model
DCS601C71

- i Thank you for purchasing intelligent Touch Controller.
- i This operation manual contains notes for safe use of the product.
For correct use, be sure to read this manual carefully before use.
- i When you have read this manual, be sure to store it in a place where the operator can conveniently refer to at anytime.
In case of personnel change, be sure to give the manual to the new operator.

Before use

Safety Considerations	
Be sure to follow the instructions below	1
System Overview	3
Features and Functions	4
Part Names and Functions	5
Part Names on the Monitoring Screen and the Functions List	7
Icon	9

Operation

Operation	
Quick Reference	13
Air Conditioner Operation	15
Monitoring Operation of Air Conditioner	26
System Setup Menu	32

Maintenance

Precautions	96
Maintenance	
LCD Maintenance	97
When Leaving the Product Turned OFF for a Long Time	97
Troubleshooting	98

For Your Information

Options	106
Specification	107
After-sales Service	108

Use smart and save smart

Safety Considerations

Please read these “SAFETY CONSIDERATIONS” carefully before installing air conditioning equipment and be sure to install it correctly.

After completing the installation, make sure that the unit operates properly during the start-up operation. Please instruct the customer on how to operate the unit and keep it maintained.

Also, inform customers that they should store this installation manual along with the operation manual for future reference.

This air conditioner comes under the term “appliances not accessible to the general public”.

Meaning of danger, warning, caution and note symbols.

⚠ DANGER Indicates an imminently hazardous situation which, if not avoided, will result in death or serious injury.

⚠ WARNING Indicates a potentially hazardous situation which, if not avoided, could result in death or serious injury.

⚠ CAUTION Indicates a potentially hazardous situation which, if not avoided, may result in minor or moderate injury. It may also be used to alert against unsafe practices.

⚠ NOTE Indicates situation that may result in equipment or property-damage-only accidents.

Keep these warning sheets handy so that you can refer to them if needed.

Also, if this equipment is transferred to a new user, make sure to hand over this operation manual to the new user.

⚠ DANGER

- **Any abnormalities in the operation of the air conditioner such as smoke or fire could result in severe injury or death.**

Turn off the power and contact your dealer immediately for instructions.

- **Do not install the unit in an area where flammable materials are present due to risk of explosion resulting in serious injury or death.**
- **Safely dispose of the packing materials.**
Packing materials, such as nails and other metal or wooden parts, may cause stabs or other injuries. Tear apart and throw away plastic packaging bags so that children will not play with them. Children playing with plastic bags face the danger of death due to suffocation.

⚠ WARNING

- **Ask your dealer for installation of the air conditioner.**
Incomplete installation performed by yourself may result in a water leakage, electric shock, and fire.
- **Ask your dealer for improvement, repair, and maintenance.**
Incomplete improvement, repair, and maintenance may result in a water leakage, electric shock, and fire.
- **Improper installation or attachment of equipment or accessories could result in electric shock, short-circuit, leaks, fire or other damage to the equipment. Be sure only to use accessories made by Daikin which are specifically designed for use with the equipment and have them installed by a professional.**
- **Ask your dealer to move and reinstall the air conditioner or the remote controller.**
Incomplete installation may result in a water leakage, electric shock, and fire.
- **Never let the indoor unit or the remote controller get wet.**
It may cause an electric shock or a fire.
- **Never use flammable spray such as hair spray, lacquer or paint near the unit.**
It may cause a fire.
- **Do not allow children to play on or around the unit as they could be injured.**
- **Never replace a fuse with that of wrong ampere ratings or other wires when a fuse blows out.**
Use of wire or copper wire may cause the unit to break down or cause a fire.
- **Never inspect or service the unit by yourself.**
Ask a qualified service person to perform this work.
- **Cut off all electric waves before maintenance.**
- **Do not wash the air conditioner or the remote controller with excessive water.**
Electric shock or fire may result.
- **Do not touch the switch with wet fingers.**
Touching a switch with wet fingers can cause electric shock.
- **Never touch the internal parts of the controller.**
Do not remove the front panel because some parts inside are dangerous to touch. In addition, some parts may be damaged by touching. For checking and adjusting internal parts, contact your dealer.
- **Check the unit stand for damage on a continuous basis, especially if it had been in use for a long time.**
If left in a damaged condition the unit may fall and cause injury.
- **Placing a flower vase or other containers with water or other liquids on the unit could result in a shock hazard or fire if a spill occurs.**

⚠ CAUTION

- **Avoid placing the controller in a spot splashed with water.**
Water coming inside the machine may cause an electric leak or may damage the internal electronic parts.
 - **Do not operate the air conditioner when using a room fumigation - type insecticide.**
Failure to observe could cause the chemicals to become deposited in the unit, which could endanger the health of those who are hypersensitive to chemicals.
 - **Do not turn off the power immediately after stopping operation.**
Always wait at least five minutes before turning off the power. Otherwise, water leakage and trouble may occur.
 - **The appliance is not intended for use by young children or infirm persons without supervision.**
 - **The remote controller should be installed in such a way that children cannot play with it.**
-

⚠ NOTE

- **Never press the button of the remote controller with a hard, pointed object.**
The remote controller may be damaged.
 - **Never pull or twist the electric wire of the remote controller.**
It may cause the unit to malfunction.
 - **Do not place the controller exposed to direct sunlight.**
The LCD display may get discolored, failing to display the data.
 - **Do not wipe the controller operation panel with benzene, thinner, chemical dustcloth, etc.**
The panel may get discolored or the coating peeled off. If it is heavily dirty, soak a cloth in water-diluted neutral detergent, squeeze it well and wipe the panel clean. And wipe it with another dry cloth.
 - **Dismantling of the unit, treatment of the refrigerant, oil and eventual other parts, should be done in accordance with the relevant local and national regulations.**
-

System Overview

This intelligent Touch Controller is capable of controlling / monitoring up to 64 **groups of indoor units** henceforth termed **group(s)**.

Main functions of the intelligent Touch Controller:

1. Collective starting / stopping of operation of the indoor units connected to the intelligent Touch Controller.
2. Starting / stopping of operation, temperature setting, switching between temperature control modes and enabling / disabling of operation with the hand-held remote control by **zone** or **group**.
3. Scheduling by **zone** or **group**.
4. Monitoring of the operation status by **zone** or **group**.
5. Display of the air conditioner operation history.
6. Forced STOP contact input from a central monitoring panel (no voltage, normally open contact).

* A **group of indoor units** include :

- ① One indoor unit without a remote control.
- ② One indoor unit controlled with one or two remote controls.

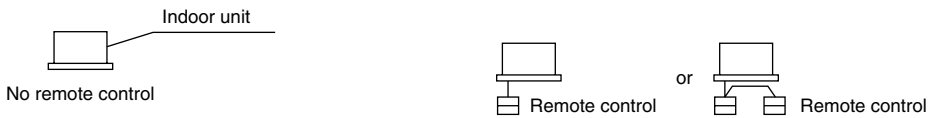

- ③ Up to 16 indoor units controlled with one or two remote controls.



* **Zone** control with the intelligent Touch Controller

* **Zone** control, which allows collective settings for more than one group, is available with the intelligent Touch Controller, which facilitates the setting operations.

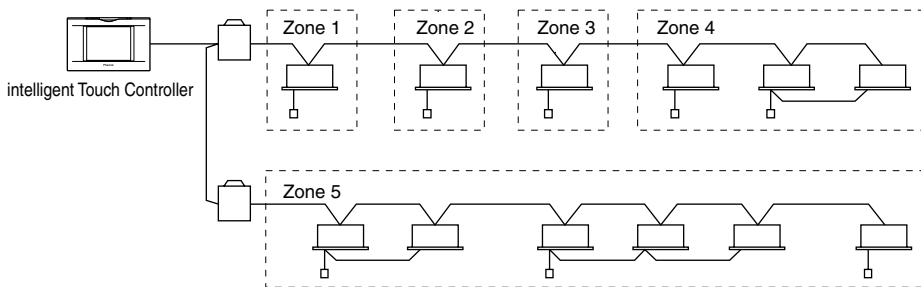

- One setting commands all of the units in one zone.
- Up to 128 zones can be set with one intelligent Touch Controller.
(The maximum number of groups in one zone is 64.)
- Groups can be zoned at will with the intelligent Touch Controller.
- Units in one group can be divided into more than one zone.

■ Operation Menu

The intelligent Touch Controller is capable of starting / stopping operation by the group or zone. Collective starting / stopping is also available.

See pages

15 to 17

■ Air Conditioner Detail Setup

Temperature setting, switching between temperature control modes, switching of speed and direction of airflow and remote control mode setting are available by the group, by the zone or collectively.

See pages

18 to 22

■ Monitoring of Various Information on Indoor Units

Information on operation such as the operation mode and temperature setting of the indoor units, maintenance information including the filter or element cleaning sign, and troubleshooting information such as error codes can be displayed by the group or the zone.

See pages

26 to 30

■ Diversified Operation Modes

Operation can be controlled both with the main unit and the remote controller to provide diversified operation management. Setting the main unit allows the following remote control settings by the group, by the zone or collectively:

- | | | |
|------------------------------|------------------------------|------------------------------|
| 1. Start/Stop | 2. Operation Mode | 3. Temperature Setting |
| : (Remote control) Inhibited | : (Remote control) Inhibited | : (Remote control) Inhibited |
| : (Remote control) Permitted | : (Remote control) Permitted | : (Remote control) Permitted |
| : Priority | | |

See page

22

■ Zone Control Simplifying Complicated Setting Operations

Up to 64 groups can be controlled with the intelligent Touch Controller. More than one group can be consolidated into a registered zone with specific settings that apply to all groups within that zone. This eliminates the need for repeating the same setting operation for each group. A collective setting for all groups is also available. Available settings are:

- Start / stop
- Temperature setting
- Switching between operation modes
- Setting of direction and fan speed
- Disabling / enabling the remote control

See pages

15 to 30

■ Detailed Scheduled Operation Control

The intelligent Touch Controller allows detailed scheduled operation by the group, by the zone or collectively. Up to 8 options for the annual schedule can be set. Each schedule can include four types of plans : Weekdays, Holidays, Special Days 1 and Special Days 2. Each of the plans allows setting of up to 16 operations.

See pages

35 to 36

■ Handy Automated Control

The Intelligent Touch Controller enables the following:

- Automatic Changeover : automatically switches between cooling and heating according to the room temperature.
- Temperature Limit : prevents the temperature from rising too high or too low in unmanned rooms.
- Heating Mode Optimization : stops uncomfortable discharge from the Indoor Unit during the Thermo-Off heating conditions.
- FC Change Over : automatically switches between cooling, heating and fan, and automatically switches intaking outside air or not, according to the room temperature and outside temperature.

See pages

37 to 53

Part Names and Functions

Front and Side View



PCMCIA Card Slot

Used when updating the intelligent Touch Controller software to a newer version and downloading the other data.

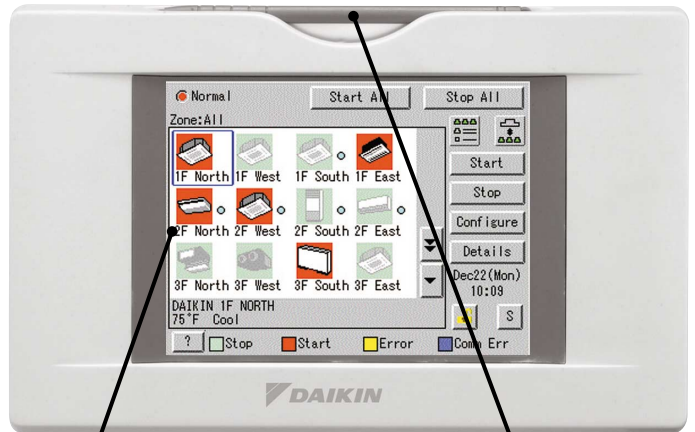

Color LCD with Touch Panel

Provides a display for monitoring and operation. Monitoring display should be operated with the touch pen. Be sure to use the touch pen provided for operation.

Touch Pen

Be sure to operate with the touch pen and take care not to lose it. In the event it is lost, contract your dealer. Use the touch pen for operation.

Note

- You must always use the provided touch pen as any other object can damage the panel. Be sure to use the touch pen for operation.

Terminals on the Back of intelligent Touch Controller

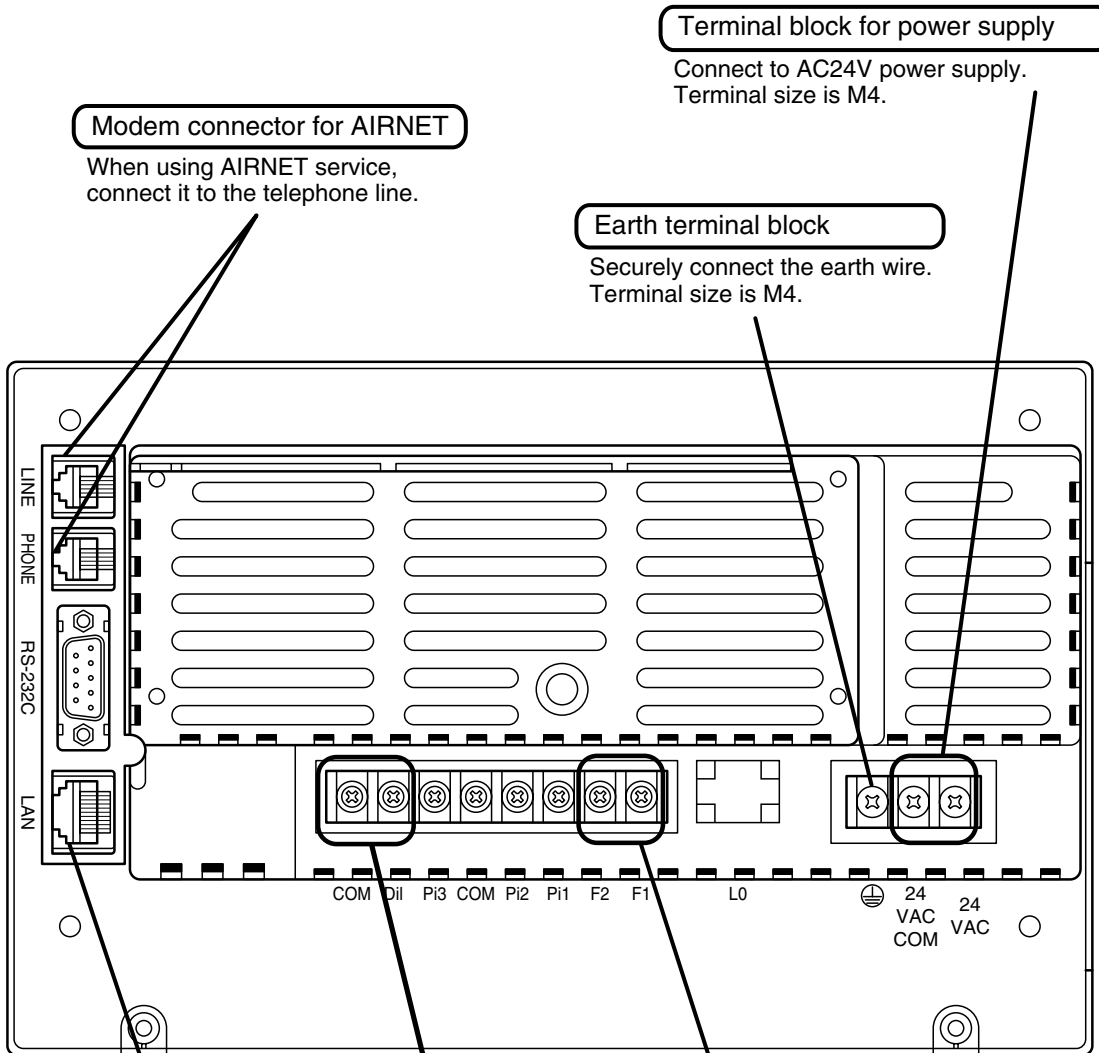

Modem connector for AIRNET

When using AIRNET service, connect it to the telephone line.

Terminal block for power supply

Connect to AC24V power supply. Terminal size is M4.

Earth terminal block

Securely connect the earth wire. Terminal size is M4.

Ethernet connector for web

When monitoring and operating the indoor units using the optional Web and E-mail function software sold separately, connect to LAN via Ethernet cable.

Terminal block for DIII-NET communication

The terminal size of the terminal block for communication with indoor units is M3.5.

Terminal block for force stop input of indoor units

This is used when stopping the indoor units compulsorily by contact input. The size of terminal block is M3.5.

Before use

Part Names on the Monitoring Screen and the Functions

List

Contents of the List Currently Displayed

- When Group List is displayed
Zone : **Zone Name**
- When Zone List is displayed
Zone List

Zone / Group Name

Set the names in the Group Registration or Zone Registration in the System Settings Mode.

Target of Automatic Control

Displayed when any air conditioner has a registered schedule in the zone or group.

Filter / Element Sign

Displayed when there is any air conditioner showing a filter or element sign in the zone or the group.

Monitoring Screen Legend

Pressing the "?" button shows more detailed legend.

Zone / Group Currently Displayed

The name of the zone / group currently selected is highlighted in light-blue.

Display Mode Selection

Press the button and display change between Zone and Group.

System Condition Displayed Domain

System condition such as Forced Stop and System Error, etc. is displayed here. When normal operation, nothing is displayed.

Normal

Start All Stop All

Zone: All

Name	Stat	Mode	Setpnt
1F North		Cool	75°F
1F West		Cool	75°F
1F South	A	Cool	75°F
1F East		Cool	75°F
2F North	A	Cool	75°F
2F West	A	Cool	75°F
2F South	A	Cool	75°F
2F East	A	Cool	75°F
3F North		Cool	75°F
3F West		Bypass	---
3F South		Cool	75°F

Start Stop Configure Details

Dec22 (Mon) 13:17

? Stop Start Error Comm Err

Button to Switch to the System Settings Mode

Use this button for settings including the time, group, zone and schedule.

List

Display for Collective Monitoring of Air Conditioners Connected to intelligent Touch Controller

When operation is normal and any air conditioner is in operation :

Red / Normal

When operation is normal and all air conditioners are in stoppage :

Green / Normal

When there is any air conditioner generating an error :

Yellow / Abnormal

When there is any air conditioner with communication error :

Blue / Abnormal

Change in color of Start/Stop is possible by Iconcolor Settings in System Settings.

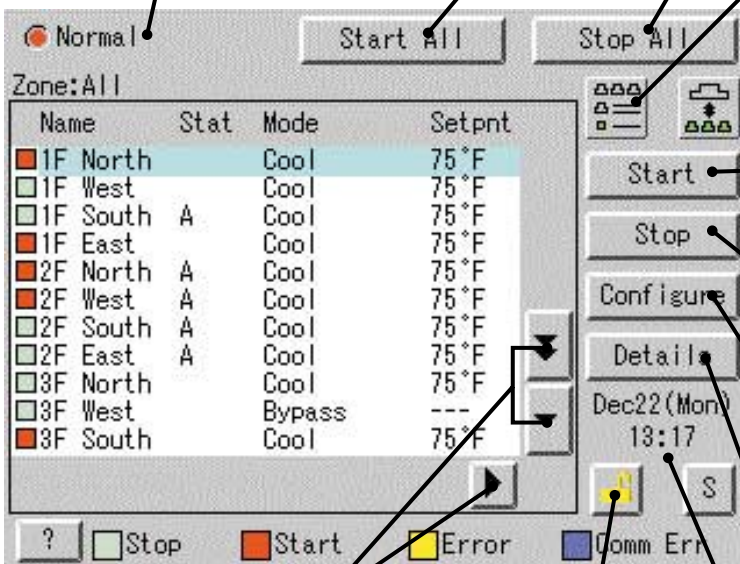

Start All Button

Button to collectively start all the air conditioners connected to intelligent Touch Controller.

Stop All Button

Button to collectively stop all the air conditioners connected to intelligent Touch Controller.

Display Mode Selection

Select the mode among icon / list / detailed icon.
See Icon Displays on Pages 9-10.
See Detailed Icon Displays on Pages 11-12.

Group / Zone Start Button

Button to start operation of the group / zone selected.

Group / Zone Stop Button

Button to stop operation of the group / zone selected.

Group / Zone Configure Button

Makes settings (temperature setting, temperature control mode, etc.) and display of the group / zone selected.

Group / Zone Details Button

Detailed display of the group / zone selected

Current Time Display

Shows the current date and time.

Scroll Buttons

Up / Down scroll button used when monitoring zone / group which are not currently displayed. Left / Right scroll button to locate areas to monitor not visible on screen.

Lock Setting / Cancel Button

Displays if monitor is locked or available to use. See detailed information on Page 31.

Icon

Contents of the List Currently Displayed

- The particular Zone being monitored appears here.
- Zone : **Zone Name**
- When Zone List is displayed Zone List Display

Zone / Group Currently Displayed

The name of the zone / group currently selected is highlighted in blue frame.

Display Mode Selection

Select between Zone and Group.

Filter / Element Sign

Displayed when there is any air conditioner showing a filter or element sign in the zone or the group.

Zone / Group Name

Set the names in the Group Registration or Zone Registration in the System Settings Mode.

Target of Automatic Control

Displayed when any air conditioner has a registered schedule in the zone or group.

Description of Zone / Group

Set the names in the Group Registration or Zone Registration in the System Setup Mode.

Monitoring Screen Legend

Pressing the “?” button shows more detailed legend.

Information on Zone / Group Currently Displayed

Generally, the temperature setting and the operation mode are displayed. If any error occurs in the air conditioner, the error code is displayed.

System Condition Displayed Domain

System condition such as Forced Stop and System Error, etc. is displayed here. When normal operation, nothing is displayed.

Displayed Abnormality in Air Conditioner or Communication

Blue or Yellow triangles indicate an abnormality in the air conditioner.

Button to Switch to the System Settings Mode

Use this button for settings including the time, group, zone and schedule.

Icon

Display for Collective Monitoring of Air Conditioners Connected to intelligent Touch Controller

When operation is normal and any air conditioner is in operation :

Red / Normal

When operation is normal and all air conditioners are in stoppage :

Green / Normal

When there is any air conditioner generating an error :

Yellow / Abnormal

When there is any air conditioner with communication error :

Blue / Abnormal

Change in color of Start / Stop is possible by Iconcolor Settings in System Settings.

Start All Button

Button to collectively start all the air conditioners connected to intelligent Touch Controller.

Stop All Button

Button to collectively stop all the air conditioners connected to intelligent Touch Controller.

Display Mode Selection

Select the mode among icon / list / detailed icon.

See List Displays on Pages 7-8.

See Detailed Icon Displays on Pages 11-12.

Group / Zone Start Button

Button to start operation of the group / zone selected.

Group / Zone Stop Button

Button to stop operation of the group / zone selected.

Group / Zone Configure Button

Makes settings (temperature setting, temperature control mode, etc.) and display of the group / zone selected.

Group / Zone Details Button

Detailed display of the group / zone selected

Current Time Display

Shows the current date and time.

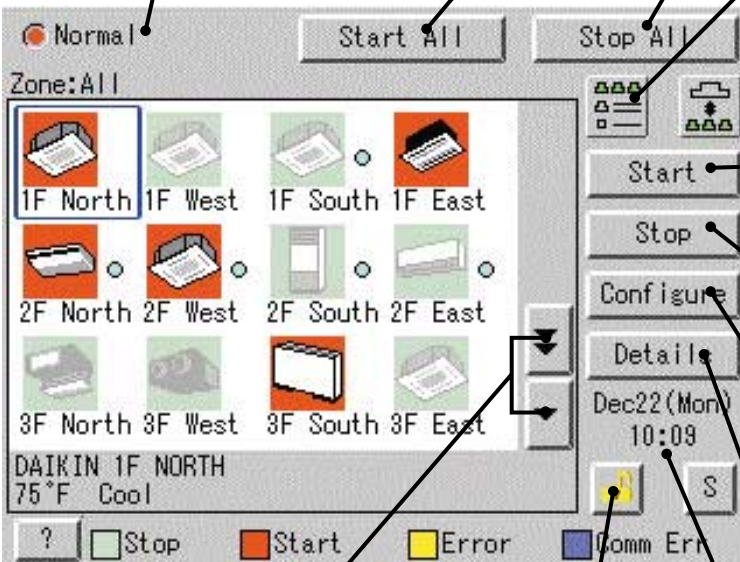

Scroll Buttons

Up / Down scroll button used when monitoring zone / group which are not currently displayed.

Lock Setting / Cancel Button

Displays if monitor is locked or available to use. See detailed information on Page 31.

Icon

Contents of the List Currently Displayed

- The particular Zone being monitored appears here.
- Zone : **Zone Name**
- When Zone List is displayed Zone List Display

Zone / Group Currently Displayed

The name of the zone / group currently selected is highlighted in blue frame.

Display Mode Selection

Press the button and a display change between Zone and Group.

System Condition Displayed Domain

System condition such as Forced Stop and System Error, etc. is displayed here. When normal operation, nothing is displayed.

Filter / Element Sign

Displayed when there is any air conditioner showing a filter or element sign in the zone or the group.

Zone / Group Name

Set the names in the Group Registration or Zone Registration in the System Settings Mode.

Target of Automatic Control

Displayed when any air conditioner has a registered schedule in the zone or group.

Displayed Abnormality in Air Conditioner or Communication

Blue triangular mark shows communication abnormality in air conditioner.
Yellow triangular mark shows abnormality in air conditioner.

Monitoring Screen Legend

Pressing the “?” button shows more detailed legend.

Button to Switch to the System Settings Mode

Use this button for settings including the time, group, zone and schedule.

Icon

Display for Collective Monitoring of Air Conditioners Connected to intelligent Touch Controller

When operation is normal and any air conditioner is in operation :

Red / Normal

When operation is normal and all air conditioners are in stoppage :

Green / Normal

When there is any air conditioner generating an error :

Yellow / Abnormal

When there is any air conditioner with communication error :

Blue / Abnormal

Change in color of Start / Stop is possible by Iconcolor Settings in System Settings.

Start All Button

Button to collectively start all the air conditioners connected to intelligent Touch Controller.

Stop All Button

Button to collectively stop all the air conditioners connected to intelligent Touch Controller.

Display Mode Selection

Select the mode among icon / list / detailed icon.

See List Displays on Pages 7-8.

See Icon Displays on Pages 9-10.

Group / Zone Start Button

Button to start operation of the group / zone selected.

Group / Zone Stop Button

Button to stop operation of the group / zone selected.

Group / Zone Configure Button

Makes settings (temperature setting, temperature control mode, etc.) and display of the group / zone selected.

Group / Zone Details Button

Detailed display of the group / zone selected

Current Time Display

Shows the current date and time.

Lock Setting / Cancel Button







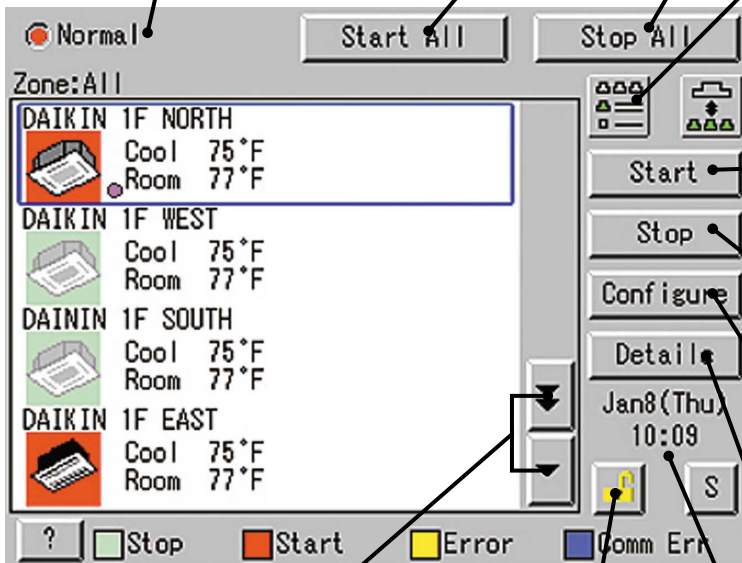



Displays if monitor is locked or available to use. See detailed information on Page 31.

Scroll Buttons







Up / Down scroll button used when monitoring zone/group which are not currently displayed.



Air Conditioner Operation

■ To collectively start / stop the operation of all devices connected to the intelligent Touch Controller	→	See page  15
■ To start / stop the operation of devices by group	→	See page  16
■ To start / stop the operation of devices by zone	→	See page  17
■ To change the operation mode	→	See page  18
■ To change the temperature setting	→	See page  19
■ To reset the filter or element sign	→	See page  20
■ To change the direction or fan speed	→	See page  21
■ To change the range of operation allowed with remote control	→	See page  22
■ To change the ventilation mode	→	See page  23
■ To change the ventilation volume	→	See page  24
■ To permit / prohibit the remote control at hand for ventilation	→	See page  25

Air Conditioner Operation Monitoring

■ To monitor by zone or by group	→	See pages  26 to  27
■ To monitor detailed information	→	See pages  28 to  29
■ To monitor the operation condition for ventilation	→	See page  30
■ To set / release the lock of screen operation	→	See page  31

System Settings Menu

■ To change the name of a group	→	See page 33
■ To change the zone settings	→	See page 33
■ To change the schedule	→	See pages 35 to 36
■ To change the Automatic Changeover	→	See pages 37 to 41
■ To change the temperature limit	→	See pages 42 to 44
■ To change the heating optimization settings	→	See pages 45 to 46
■ To change the FC Change Over settings	→	See pages 47 to 53
■ To calibrate the touch panel	→	See page 62
■ To review the history of errors	→	See page 62
■ To set the locale	→	See page 34
■ To set the icon color	→	See page 34
■ To set the network	→	See page 34
■ To set the activation key	→	See page 34
■ To adjust the contrast of the screen	→	See page 105
■ To set the e-mail	→	See pages 54 to 56
■ To set the Simple Interlock	→	See pages 57 to 61

Starting / Stopping Operation Collectively

Screen 1 Monitoring

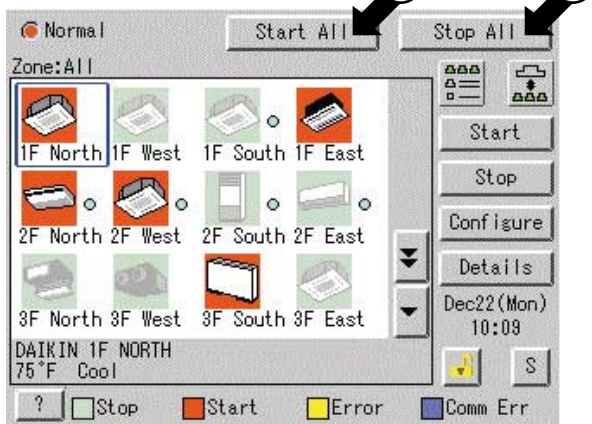

Screen 2 Confirm

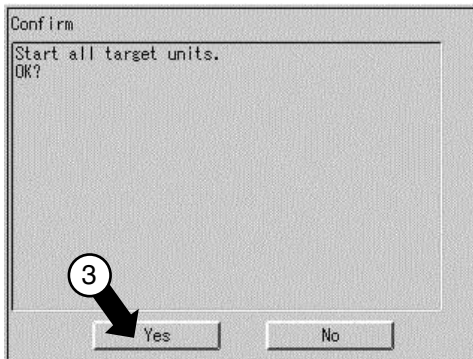

To start / stop the operation of all devices connected

Start or stop collectively the operation of devices connected.

On the Monitoring screen, operation is allowed with either Zone or Group as the display mode and with either Icon or List as the display type. In the example on the left, the display mode is Group in the collective mode and the display type is Icon.

[Procedure]

1. On Screen 1 Monitoring, press the [Start All] button ① or [Stop All] button ②.
2. Screen 2 appears to confirm. Press the [Yes] button ③.
To exit without activating collective start or stop, press the [No] button.

Starting / Stopping Operation by the Group

Screen 1 Monitoring

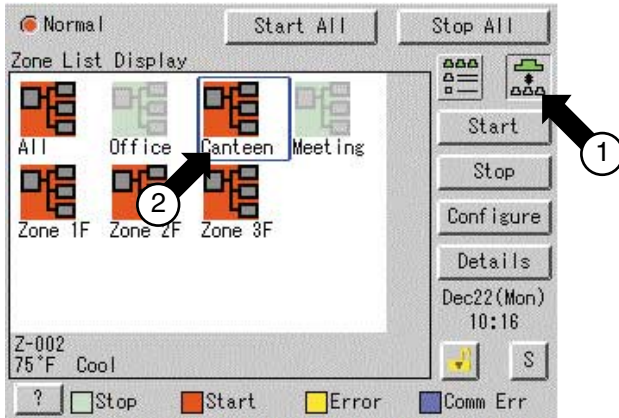

Screen 2 Monitoring (Group)

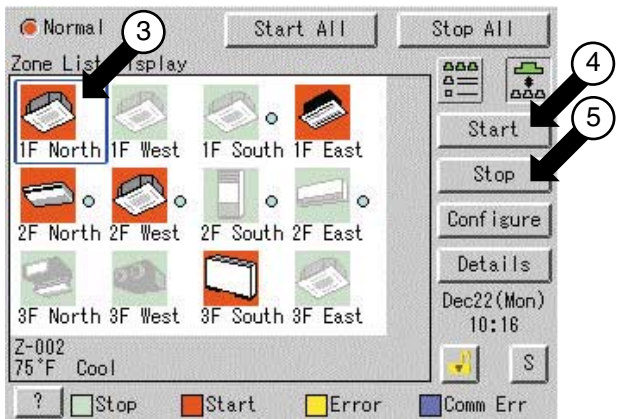

To start / stop the operation of devices by group

Start or stop the operation of air conditioners by group.

The example on the left shows the screen for starting / stopping the operation of Group Name : 1F North registered for Zone Name : Canteen.

Zone Name

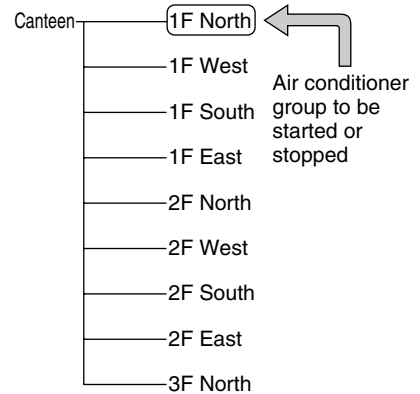

[Procedure]

1. On Screen 1 Monitoring, select a zone from the button ①.
2. Select a zone that includes the group of which the operation is to be started or stopped ②.
3. Select a group from the button ③. Screen 2 Monitoring (Group) appears.
4. Select a group to be started or stopped as in ③ and press the [Start] button ④ or [Stop] button ⑤.

Starting / Stopping Operation by the Zone

Screen 1 Monitoring

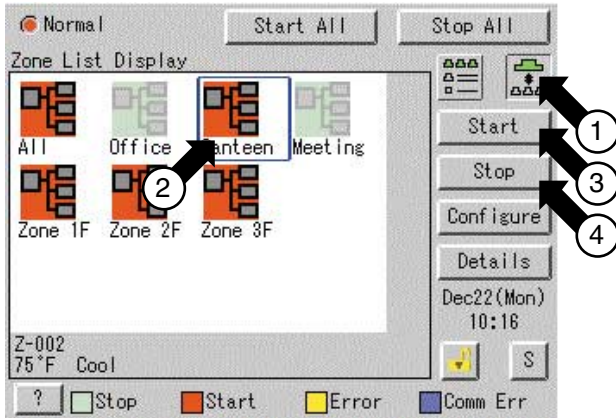

To start / stop the operation of devices by group

Start or stop by zone the operation of groups of air conditioners set in zones.

The example on the left shows a screen for starting or stopping the operation of air conditioners in the canteen.

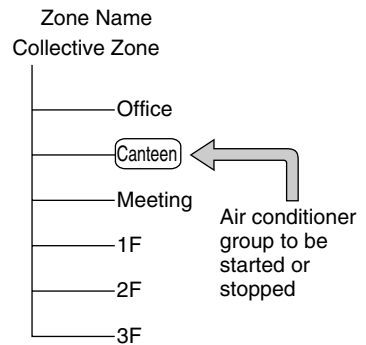

[Procedure]

1. On Screen 1 Monitoring, select a zone from the button ①.
2. Select the zone of which the operation is to be started / stopped as shown in ②.
3. Press the [Start] button ③ or [Stop] button ④.

Switching the Operation Mode

Screen 1 Monitoring

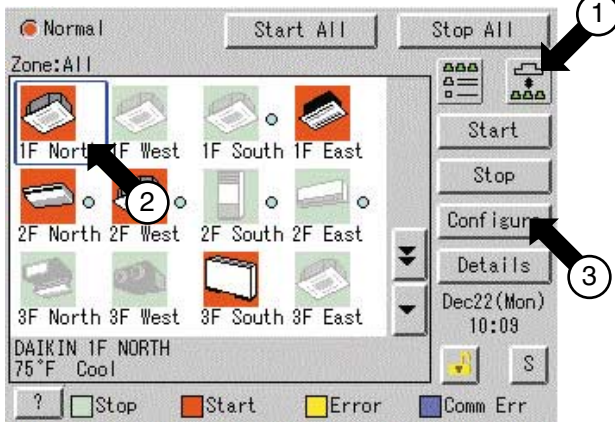

Screen 2 Operation

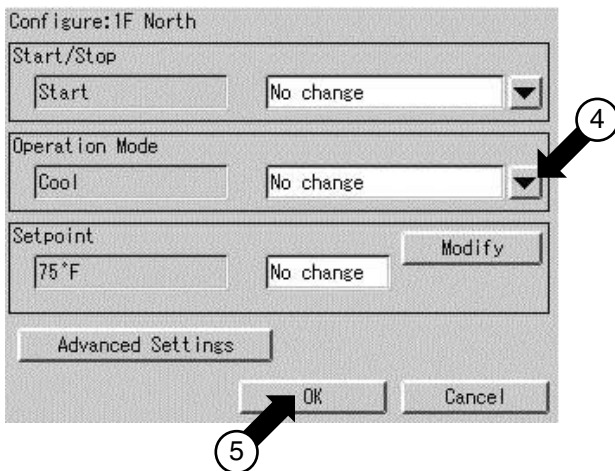

Switch the operation mode of the air conditioner.

On the Monitoring screen, operation is allowed with either Icon or List as the display type.

The operation mode can be switched by zone or by group.

Selecting a zone and switching the operation mode switches the mode of all air conditioners in the zone.

Selecting a group and switching the operation mode switches the mode of air conditioners in the group selected.

[Procedure]

1. On Screen 1 Monitoring, select a zone or a group from the button ①.
2. Select with ② a zone or a group of which the operation mode is to be switched.
3. Press the [Configure] button ③. Screen 2 Operation is displayed.
4. Select the operation mode to be set from the pull down menu ④.
On the menu, operation modes available for air conditioners in the zone are displayed if the switching is to be made by zone. See the example below.
5. Press the [OK] button ⑤.
To cancel the setting, press the Cancel button.

Ex.: For the following zone setting, the operation modes available are Fan, Cool, Heat and Auto.
If Changeover option is not available for any air conditioner in the zone, Fan and Dependent are the available operation modes.

Zone name	Group name	Operation modes available
Canteen	1F North	Cool Fan
	1F West	Cool Heat Auto Fan

Changing the Temperature Setting

Screen 1 Monitoring

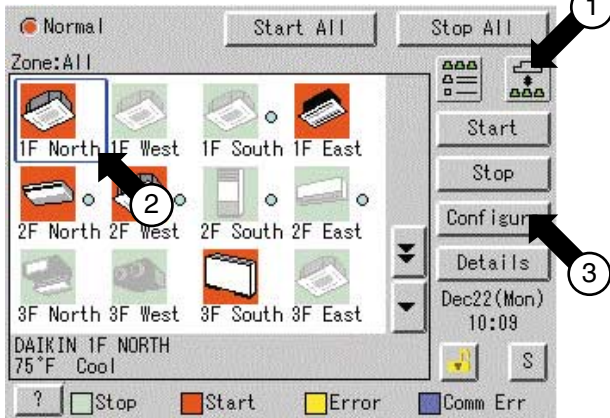

Screen 2 Operation

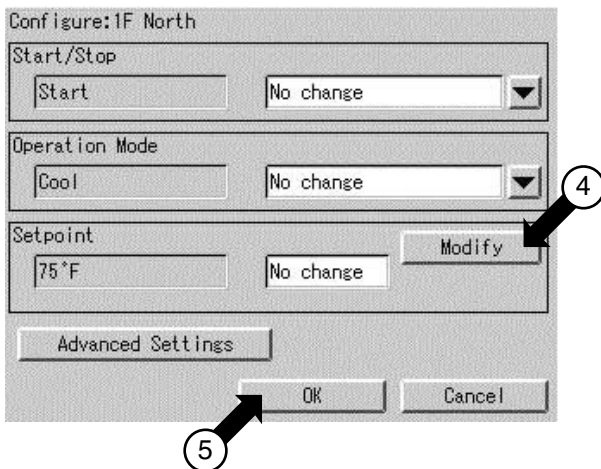

Change the temperature setting of air conditioners.

On the Monitoring screen, operation is allowed with either Icon or List as the display type.

The temperature setting can be switched by zone or by group.

Selecting a zone and changing the temperature setting changes the setting of the air conditioner groups in each selected operation in the zone.

Selecting a group and changing the temperature setting changes the temperature setting of air conditioners in the group selected.

If all of the air conditioners in the group selected are in Fan operation, temperature setting cannot be changed.

[Procedure]

1. On Screen 1 Monitoring, select a zone or a group from the button ①.
2. Select a zone or a group of which the temperature setting is to be changed ②.
3. Press the [Configure] button ③. Screen 2 Operation is displayed.
4. For temperature setting, press the [Modify] button ④. Setpoint dialog is displayed and input temperature for setting. On the menu, temperature settings available for air conditioners in the zone are displayed if the setting is to be made by the zone. See the example below.
5. Press the [OK] button ⑤. To cancel the setting, press the [Cancel] button.

Ex.: For the following zone setting, the temperature settings available are between 68°F and 86°F inclusive.

Zone name	Group name	Range of temperature settings available (see Note)
Canteen	1F North	11 to 86°F
	1F West	68 to 77°F

When the temperature setting is 86°F, the actual temperature settings for air conditioners are as shown below:

Group name	Temperature setting
1F North	86°F
1F West	77°F

Note: Range of temperature settings available is the range specified in accordance with the following.

- Range of temperature setting inherent to the air conditioner main unit.
- Range of temperature as a result of the restriction by the temperature setting limit.

See page  67

Resetting the Filter / Element Sign

Screen 1 Monitoring

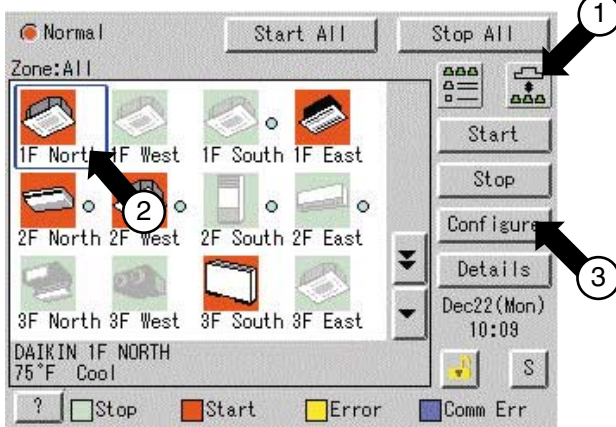

Screen 2 Operation

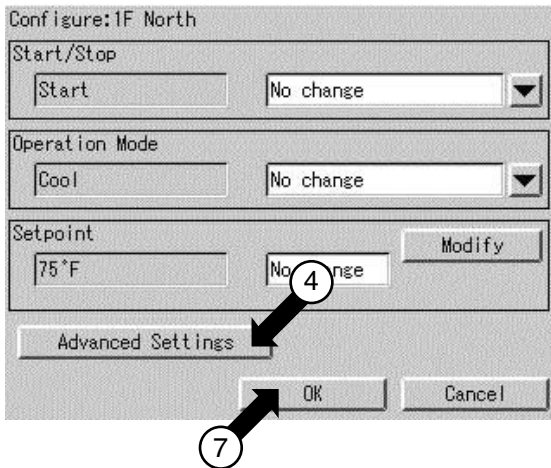

Screen 3 Advanced Settings

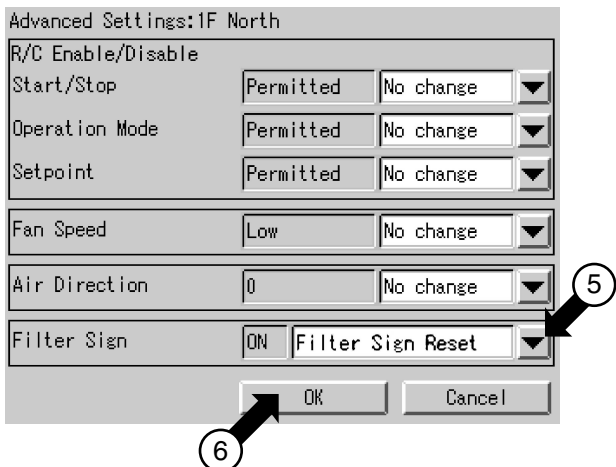

Reset the filter or element sign after cleaning any air conditioner showing the filter or element sign.

On the Monitoring screen, operation is allowed with either Icon or List as the display type.

The filter or element sign can be reset by zone or by group.

[Procedure]

1. On Screen 1 Monitoring, select a zone or a group from the button ①.
2. Select a zone or a group of which the filter or element sign is to be reset ②.
3. Press the [Configure] button ③. Screen 2 Operation is displayed.
4. Press the [Advanced Settings] button ④. Screen 3 Advance Operation is displayed.
5. To reset the filter / element sign, select **Filter Sign Reset** in pull-down menu ⑤. Then press the [OK] button ⑥. To cancel the setting, press the [Cancel] button. Screen 2 Operation is displayed again.
6. Then press the [OK] button ⑦ on Screen 2 Operation. To cancel the setting, press the [Cancel] button.

Changing the Direction / Fan Speed

Screen 1 Monitoring

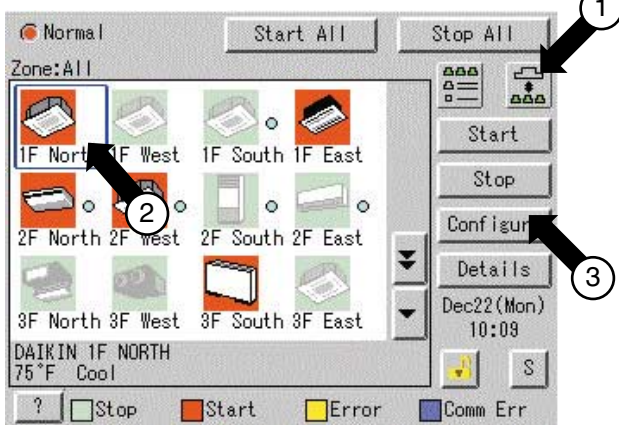

Screen 2 Operation

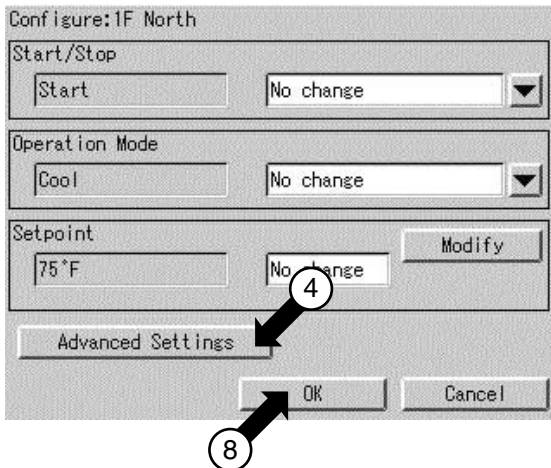

Screen 3 Advanced Settings

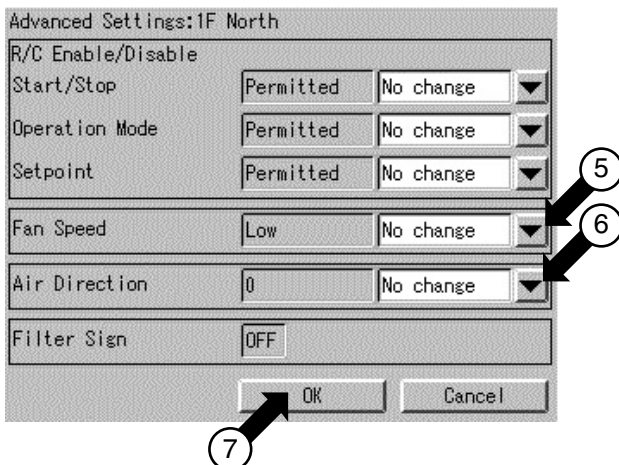

Change the air direction or volume of air conditioners.

On the Monitoring screen, operation is allowed with either Icon or List as the display type.

The air direction or volume can be changed by zone or by group.

[Procedure]

1. On Screen 1 Monitoring, select a zone or a group from the button ①.
2. Select a zone or a group of which the air direction or volume is to be reset ②.
3. Press the [Configure] button ③. Screen 2 Operation is displayed.
4. Press the [Advanced Settings] button ④. Screen 3 Advance Settings is displayed.

5. Set the direction with the pull-down menu ⑥.

The larger the value for wind direction setting (0 - 6), the closer to vertical the direction becomes. The value 7 indicates automatic swing.

(Note: See the figure below.)

The description given above may not exactly apply depending on the model. Check the airflow direction sign on the remote control after operation.

Select the Fan Speed with the pull-down menu ⑤.

Then press the [OK] button ⑦.

To cancel the setting, press the [Cancel] button.

Screen 2 Operation is displayed again.

6. Then press the [OK] button ⑧ on Screen 2 Operation. To cancel the setting, press the [Cancel] button.

Note: Guidelines for airflow direction value and actual direction

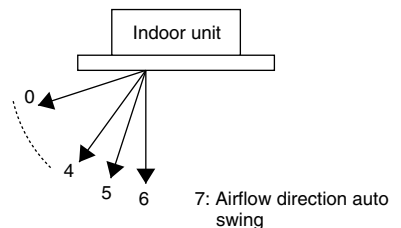

Changing the Range of Operation Allowed with Remote Control

Screen 1 Monitoring

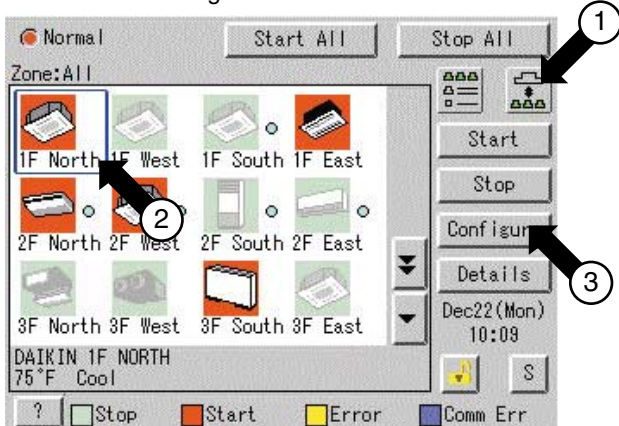

Screen 2 Operation

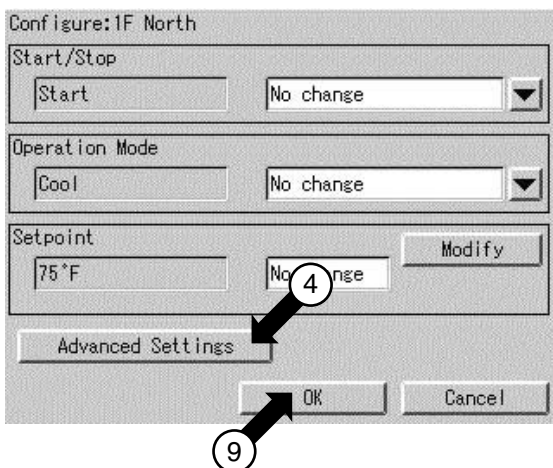

Screen 3 Advanced Settings

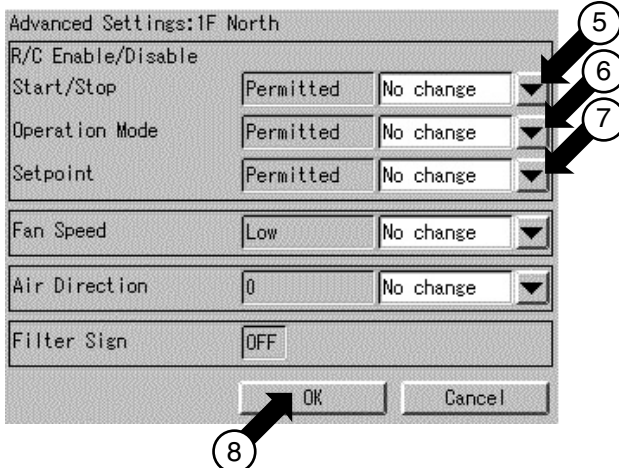

Change the setting of operation with the remote control of air conditioners between Permitted and Prohibited.

On the Monitoring screen, operation is allowed with either Icon or List as the display type.

The setting between Permitted and Prohibited can be changed by zone or by group.

[Procedure]

1. On Screen 1 Monitoring, select a zone or a group from button ①.
2. Select with ② a zone or a group for which the setting of the range of operation allowed with remote control is to be reset.
3. Press the [Configure] button ③. Screen 2 Operation is displayed.
4. Press the [Advanced Settings] button ④. Screen 3 Advance Settings is displayed.
5. Then make setting with the pull-down menus ⑤ - ⑦.

There are three settings as shown below:

- ⑤ Start/Stop
Prohibited
Stop Only
Permitted
No change
- ⑥ Operation Mode
Permitted or Prohibited
No change
- ⑦ Setpoint
Permitted or Prohibited
No change

Press the [OK] button ⑧ after setting ⑤ - ⑦.

To cancel the setting, press the [Cancel] button.

Screen 2 Operation is displayed again.

6. Then press the [OK] button ⑨ on Screen 2 Operation. To cancel the setting, press the [Cancel] button.

[Details of Setting]

Item	Setting	Meaning
Start/Stop	Prohibited	The remote control cannot start or stop operation.
	Stop Only	The remote control can stop the operation of air conditioners in operation but cannot start air conditioners not in operation.
	Permitted	The remote control can start or stop operation.
Operation Mode	Permitted	The remote control can change the operation mode.
	Prohibited	The remote control cannot change the operation mode.
Setpoint	Permitted	The remote control can change the temperature setting.
	Prohibited	The remote control cannot change the temperature setting.

Set Ventilation Mode

Screen 1 Monitoring (Icon)

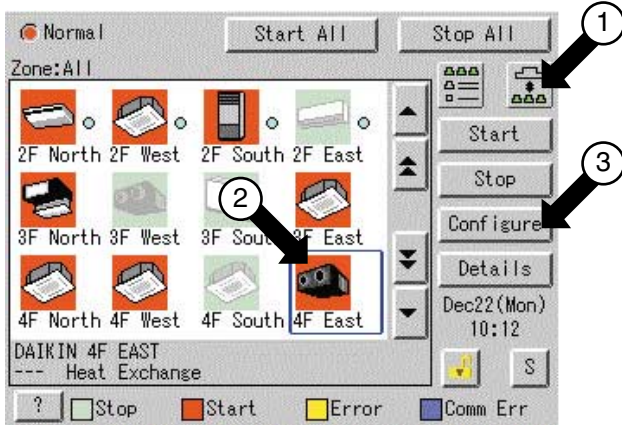

Screen 2 Operation

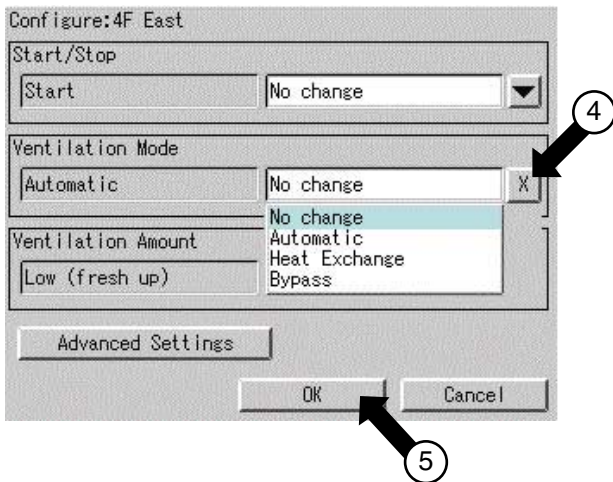

Perform the following procedure to switch the ventilation mode:

On the monitoring screen, you can select any of the following display types: Icon, Detailed Icon, or List.

When changing the ventilation modes of all the ventilation groups of a zone, select the zone and switch the ventilation mode.

When changing the ventilation mode of a group, select the group and switch the ventilation mode.

[Procedure]

1. On Monitoring Screen Screen 1, select a zone or group by pushing the button ①.
2. To select a zone or group subject to ventilation mode switching, push the icon ②.
3. Push [Configure] button ③ to display Operation Screen Screen 2.
4. Select a desired ventilation mode on the pull-down menu ④.
5. Last, press [OK] button ⑤.
To cancel above settings, press [Cancel] button.

* Not all models permit the above settings.

Set Ventilation Volume

Screen 1 Monitoring

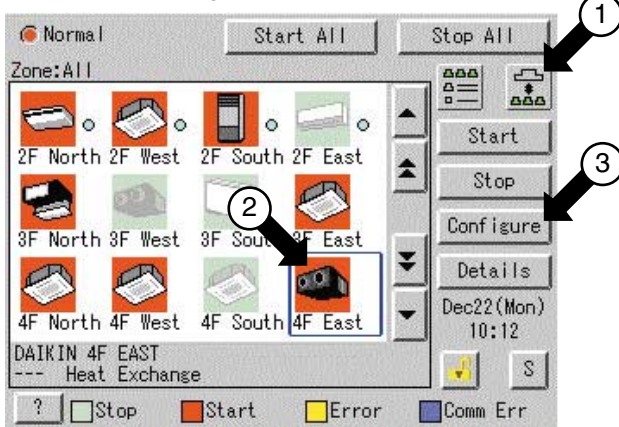

Screen 2 Operation

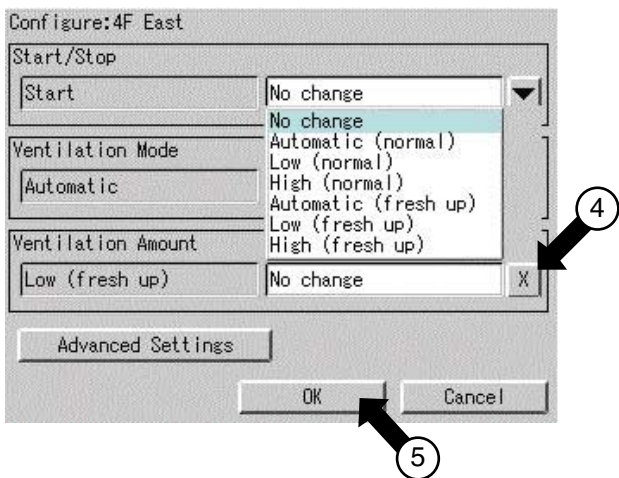

Perform the following procedure to change the ventilation volume:

On the monitoring screen, you can select any of the following display types: Icon, Detailed Icon, or List.

When changing the ventilation volumes of all the ventilation groups of a zone, select the zone and switch the ventilation volume.

When changing the ventilation volume of a group, select the group and switch the ventilation volume.

[Procedure]

1. On the Monitoring Screen Screen 1, select a zone or group by pushing the button ①.
2. To select a zone or group subject to ventilation volume switching, push the icon ②.
3. Push [Configure] button ③ to display Operation Screen Screen 2.
4. Select a desired ventilation volume on the pull-down menu ④.
5. Lastly, push [OK] button ⑤.
To cancel above settings, press [Cancel] button.

* Not all models permit the above settings.

Permit / Inhibit setting of Ventilation Remote Control Operations

Screen 1 Monitoring

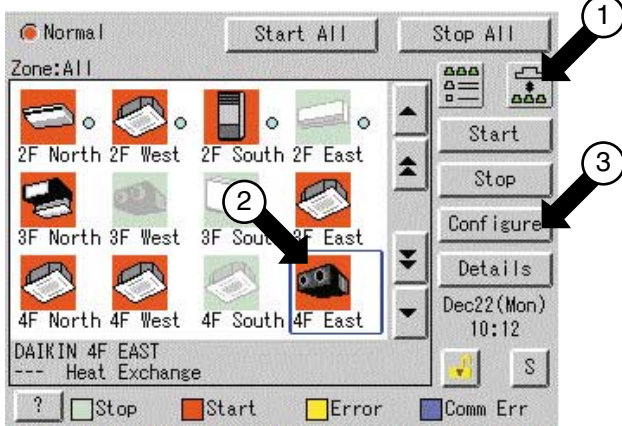

Screen 2 Operation

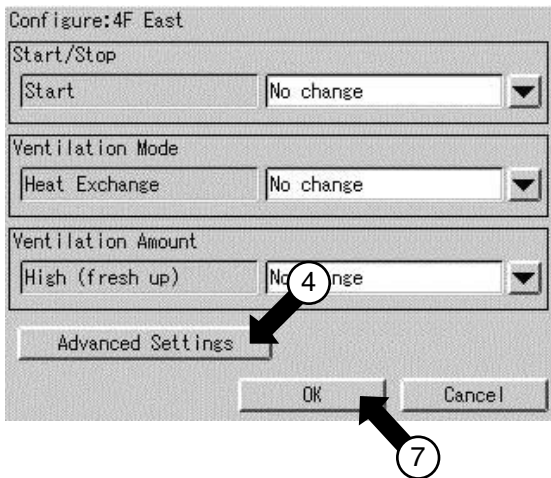

Screen 3 Advanced Settings

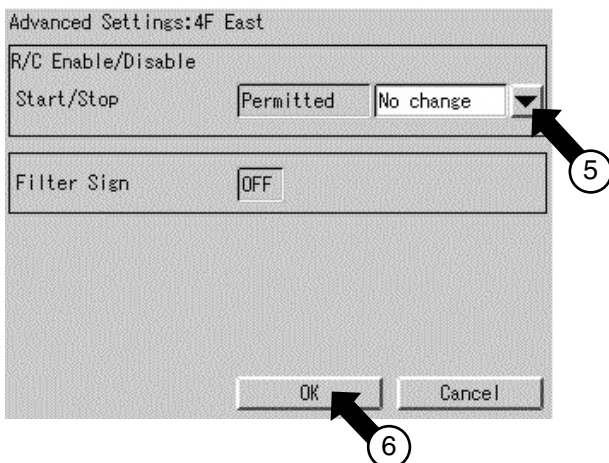

Perform the following procedure to enable or disable the ventilation remote control operations:

On the monitoring screen, you can select any of the following display types: Icon, Detailed Icon, or List.

You may enable or disable the remote control operations in units of zones or groups.

[Procedure]

1. On the Monitoring Screen Screen 1, select a zone or group by pushing the button ①.
2. To select a zone or group subject to ventilation volume switching, push the icon ②.
3. Push [Configure] button ③ to display the Set Screen Screen 2.
4. Push [Advanced Settings] button ④ to display the Advanced Settings Screen Screen 3.
5. Make a desired setting on the pull-down menu ⑤.
You can enable or disable the following setup items for remote control:
Prohibited
Stop Only
Permitted
No change
- After making the setting, push [OK] button ⑥ to display the Set Screen Screen 2 again.
To cancel above settings, push [Cancel] button.
6. Lastly, push [OK] button ⑦ on the Set Screen.
To cancel above settings, push [Cancel] button.

* Not all models permit the above settings.

[Details of Setting]

Item	Setting	Meaning
Start/Stop	Prohibited	The remote control cannot start or stop operation.
	Stop Only	The remote control can stop the operation of air conditioners in operation but cannot start air conditioners not in operation.
	Permitted	The remote control can start or stop operation.

Monitor Zone or Group Operation Status

Screen 1 Monitoring (Icon Display)

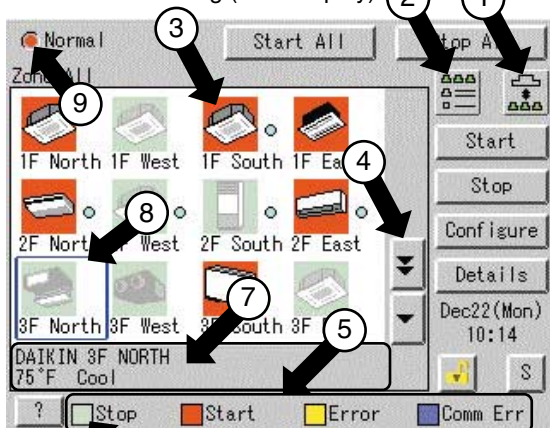

Screen 2 Monitoring (Detailed Icon Display)

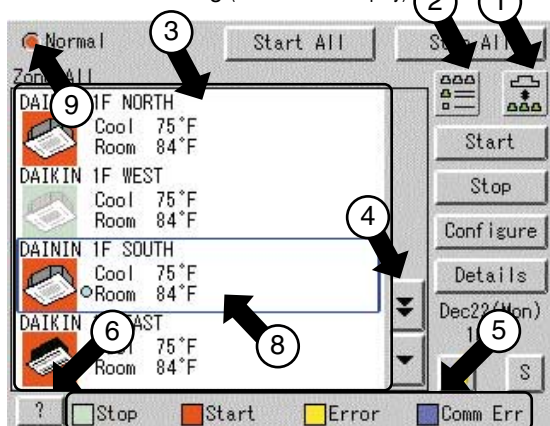

Screen 3 Monitoring (List Display)

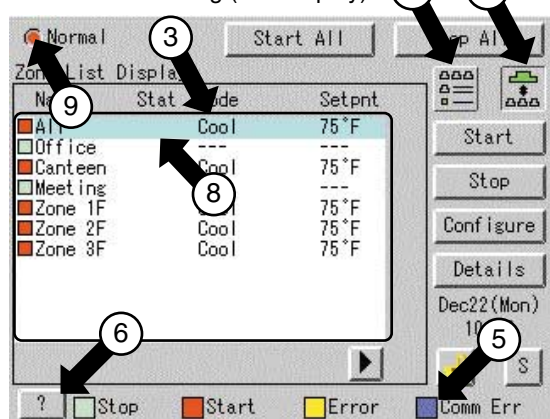

Monitor Zone or Group Operation Status

On the monitoring screen, you can select any of the following display types: Icon, Detailed Icon, or List. Push the button ② to select a display type. Display type selection takes place repeatedly in the order of icon, detailed icon and list.

You may monitor the operation status in units of zones or groups. Examples of display types are shown in left figures.

- Screen 1 Display type : Icon
Unit of monitoring : Group
- Screen 2 Display type : Detailed icon
Unit of monitoring : Group
- Screen 3 Display type : List
Unit of monitoring : Zone

[Descriptions of Display Items on the Screen]

At ③ displays information concerning a zone or group, including the operation active or inactive status and the presence / absence of faults, automatic control settings, filters and element signs, etc.

Push the button ④ to change a display scope. When the number of registered zones or groups is small and all the zones or groups can be displayed within one screen, this button does not appear. See Screen 3.

Display of ⑤ indicates a legend. When requiring a more detailed legend, display the Legend Description Screen Screen 4 on the next page by pushing the [?] button ⑥.

To return to the previous screen, push Close button.

⑧ displays the current zone or group. You may select another zone or group by pushing the screen.

On Screen 1, ⑦ displays the settings of the zone or group selected at ⑧. (Icon display only) Display takes place in the following order:

- Upper : Detailed name for a zone or group
 - Lower left : Setting temperature
For a zone, this also indicates the temperature set for the representative machine (Note).
 - Lower right : Operation mode
For a zone, this also indicates the operation mode for the representative machine (Note).
- When an error occurs, the corresponding error code is indicated in the lower area.

Monitor Zone or Group Operation Status

Screen 4 Legend Description

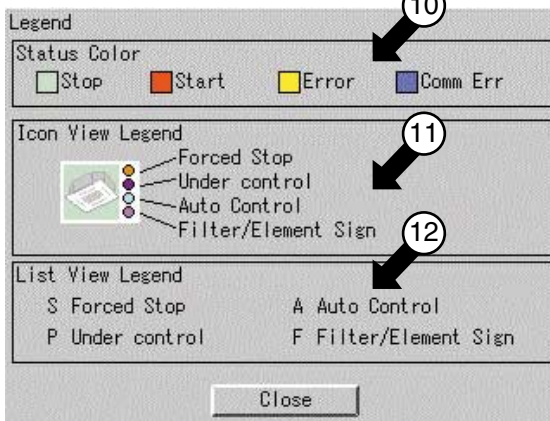

At ⑨, you can monitor at a glance the operation status of all air conditioners connected to the intelligent Touch Controller.

When no problem is found and one or more air conditioners are operating : Display in red

When no problem is found and air conditioners are not operating : Display in green

When one or more wrong air conditioners are found : Display in yellow

When one or more air conditions with communication errors are found : Display in blue

You may change the colors indicating the operation active or inactive status through the use of Icon Color Setting on the System Setting menu.

See page 34 for Icon color setting.

NOTE: Representative zone

When monitoring takes place in units of groups on the Monitoring Screen, the following groups indicate the zone representative machines.

- When the display type is icon : Leftmost group on the top line
- When the display type is detailed icon or list: Groups on the top line.

⑩ displays the operation status of an air conditioner.

For zone list display, display takes place as shown below.

- When no problem is found and one or more air conditioners are operating : Display in red
- When no problem is found and no air conditioner is operating : Display in green
- When one or more wrong air conditioners are found : Display in yellow
- When one or more air conditions with communication errors are found : Display in blue

You may change the colors indicating the operation active or inactive status through the use of Icon Color Setting on the System Setting menu.

See page 34 for Icon color setting.

⑪ provides for icon or detailed icon display.

⑫ provides for list display.

Machines subject to automatic control are displayed only when schedule settings are made.

They cannot be displayed when Heating Mode Optimization or Temperature Limit has been set.

Monitoring Detailed Information

Screen 1 Monitoring (Icon Display)

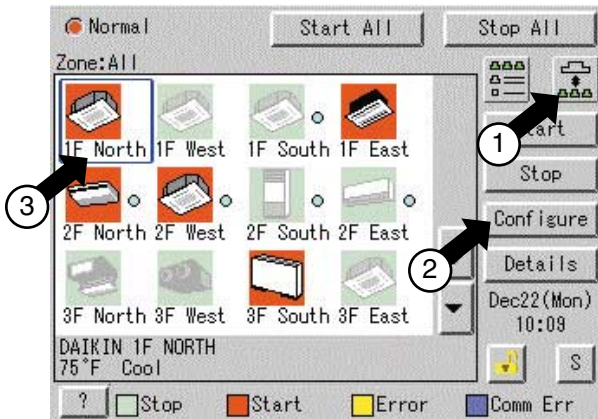

Screen 2 Operation Screen

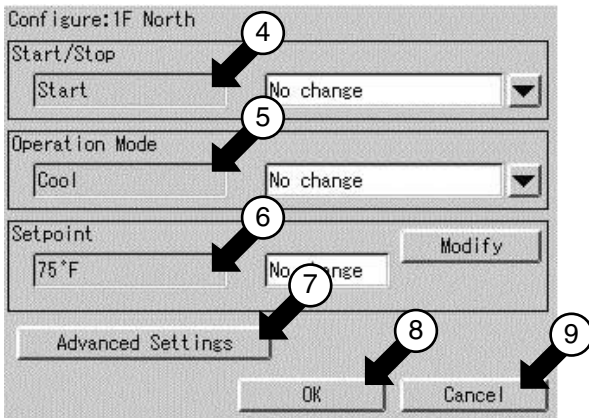

Screen 3 Advanced Settings Screen

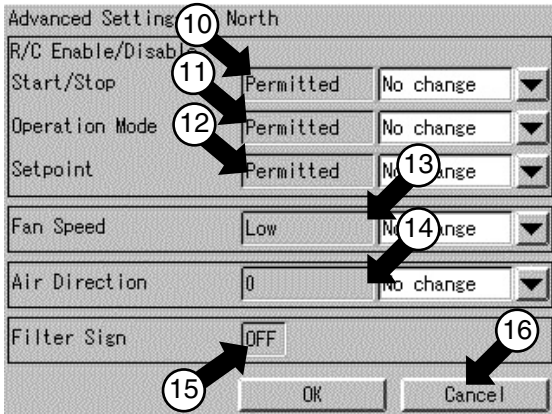

Monitor Operation Status of a Zone or Group in Detail

When monitoring the operation status in detail, you may choose any of three display types, icon, detailed icon and list.

You may monitor the details of the operation status in units of zones or groups.

1. Select either Zone or Group by pushing the button ①.

Note that screens in the left-hand column are examples for group selection.

2. Push [Configure] button ② to display the Operation Screen Screen 2.

When a zone is selected in the above operation, both ④ to ⑥ on Screen 2 and ⑩ to ⑭ on Screen 3 show the operation status of the representative machine in that zone. ⑮ displays ON so long as at least one of the filter signs or element signs is on in the zone or group.

The following describes in order the contents of display data on Screen 2. The grayed characters in ④ to ⑥ indicate the current status of the selected zone or group. The meanings of screen data in the left-hand column are shown below.
 Operation start/stop status : Start
 Operation mode setting status : Cool
 Setpoint setting status : 75°F

3. Push [Advanced Settings] button ⑦ to display the Advanced Settings Screen Screen 3. To return to the Monitoring Screen Screen 1, push [Cancel] button ⑨.

The following describes in order the contents of display data on the Advanced Settings Screen Screen 3.

- ⑩ displays the settings made for start and stop remote control operations. Prohibited, Stop Only or Permitted is displayed.
- ⑪ displays the settings made for remote control operations to change the operation mode. Either Permitted or Prohibited is displayed.
- ⑫ displays the settings for remote control operations to change the setting temperature. Either Permitted or Prohibited is displayed.
- ⑬ displays the current status of the Fan Speed.
- ⑭ displays the direction of wind. A value from 1 to 7 is displayed. Wind flows more vertically as the setting value becomes larger in a range from 0 to 6. When the setting value 7 is displayed, the direction of wind is swung automatically. Note that these descriptions may vary from model to model. Check for a wind direction displayed on the remote control.
- ⑮ displays a filter sign. Either ON and OFF is displayed.

* Display data on Screens 2 and 3 is updated each time the respective screens are displayed. Once these screens are displayed, no data is updated unless they are closed and opened again.

4. Check the settings and push [Cancel] button ⑩.

Monitoring Detailed Information

Screen 4 Monitoring Screen (Icon Display)

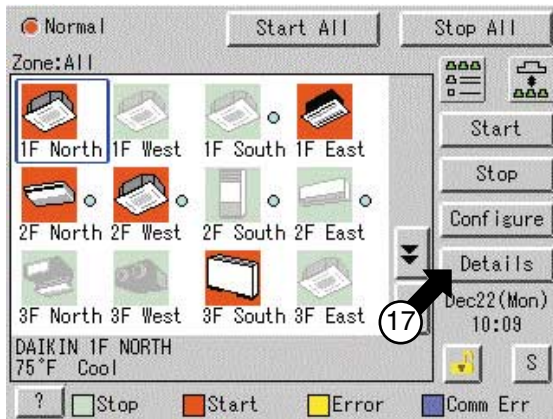

Screen 5 Detailed Information Screen

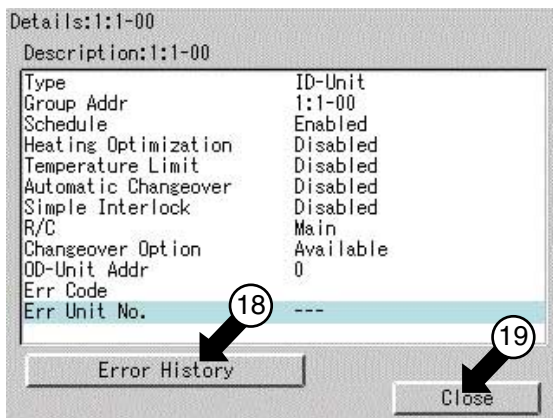

Screen 6 Error History

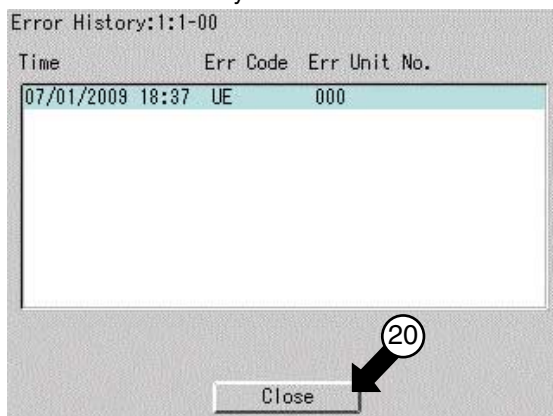

5. Push [Details] button ⑰.

The following maintenance data is displayed on the Detailed Information Screen Screen 5.

Note that screens in the left-hand column are examples for group selection.

[For group selection]

Name : Group name
 Detailed name : Detailed group name
 Type : ID-Unit / HRV / D3Dio / D3Di
 Group Address : 1:1-00 to 1:4-15
 When DIII-NET Plus adapter is enabled:
 1:1-00 to 2:4-15
 Schedule : Enabled or disabled
 Heating Optimization : Enabled or disabled
 Temperature Limit : Enabled or disabled
 Automatic Changeover: Enabled or disabled
 R / C : Main or Sub
 Changeover Option : N/A / Available / Selectable
 OD-Unit Address : Outside unit address
 Err Code : 2-digit error code in case of error occurrence
 Err Unit No.
 : [-] for no error or unit number for error

[For zone selection]

Details : Zone name
 Description : Detailed zone name
 Sequential Start : Enabled or disabled
 No. of Regist Grp : Number of groups registered in a zone
 Schedule : Enabled or disabled

6. Push [Error history] button ⑱ to display the Error History Screen (Screen 6).

The following data is displayed on the Error History.

[For group selection]

Name : group name
 Detailed name : Detailed group name
 Error log :
 • Time : Error occurrence time
 • Err Code : 2-digit error code
 • Err Unit No : Unit number

[For zone selection]

Name : group name
 Error log :
 • Time : Error occurrence time
 • Name : Error occurrence group name
 • Err Code : 2-digit error code
 • Err Unit No : Unit number

Top 10 error logs are displayed, assigning the highest priority to the time of the latest error.

* When the same error recurs, the error time is renewed.

Check for display data and push [Close] button ⑳ to return to the detailed information screen Screen 5. To return to the Monitoring Screen Screen 4, push [Close] button ⑲ on that screen.

Monitoring Detailed Information

Screen 1 Monitoring (Icon)

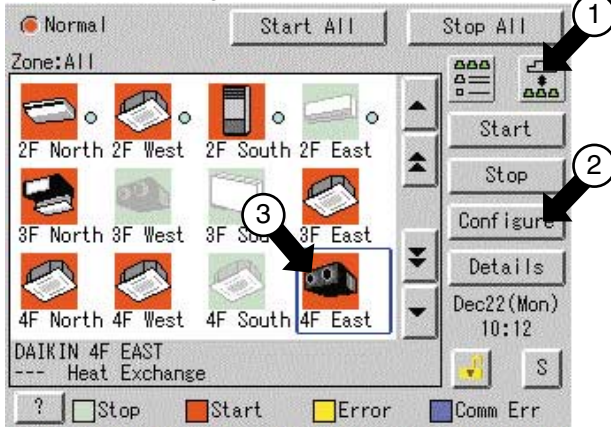

Screen 2 Operation

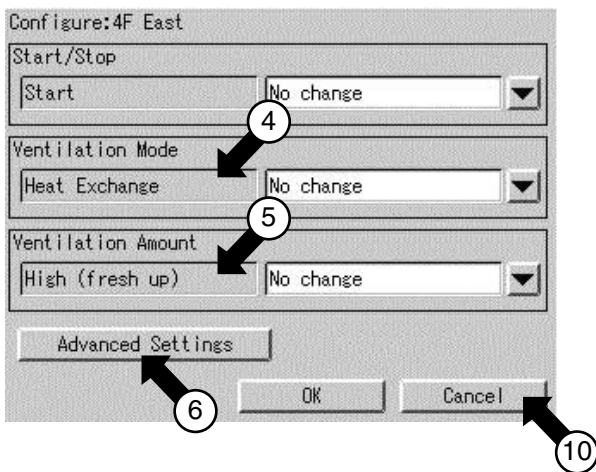

Screen 3 Advanced Settings

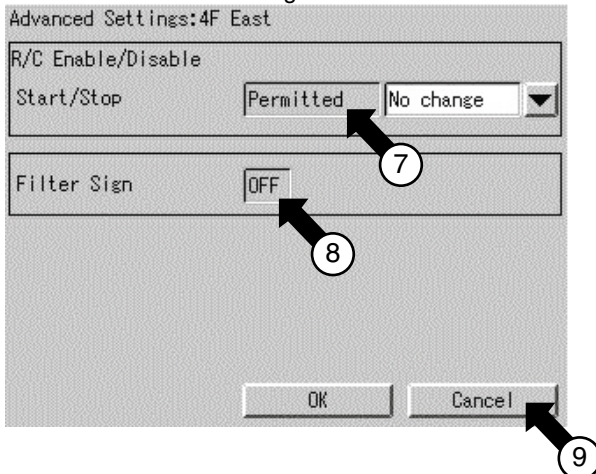

Monitor Ventilation Status of a zone or group in Detail
When monitoring the operation status in detail, you may choose any of three display types, icon, detailed icon and list.

You may monitor the details of the operation status in units of zones or groups.

1. Select either Zone or Group by pushing the button ①.

Note that the screens in the left-hand column are examples of Group choices.

2. Push [Configure] button ② to display Operation Screen Screen 2.

The following describes in order the contents of display data on Screen 2.

The grayed characters ④ and ⑤ indicate the current status of the selected zone or group.

The following data is displayed on the screen of the left-hand column.

Ventilation mode : Heat Exchange
Ventilation amount : High (Fresh up)

3. Push the [Advanced Settings] button ⑥ to display the Advanced Settings screen Screen 3.

To return to the Monitoring Screen Screen 1, push [Cancel] button ⑩.

The following describes in order the contents of display data on the Advanced Settings screen Screen 3.

⑦ displays the settings made for start- or stop-related remote control operations.

Prohibited, Stop Only or Permitted is displayed.

⑧ displays a filter sign.

ON or OFF is displayed.

* Display data on Screens 2 and 3 is updated each time the respective screens are displayed. Once these screens are displayed, data is not updated unless they are closed and opened again.

4. Check for display data and push [Cancel] button ⑨.

To set / release the lock of screen operation

Screen 1 Monitoring (Icon)

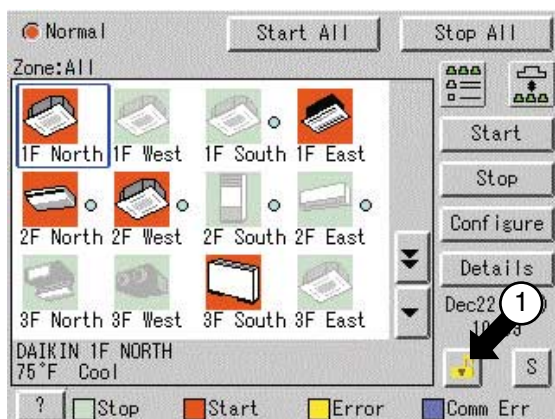

Screen 2 Confirm

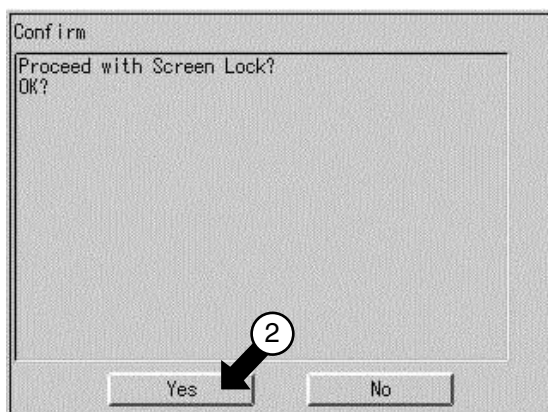

Screen 3 Password to release Screen Lock

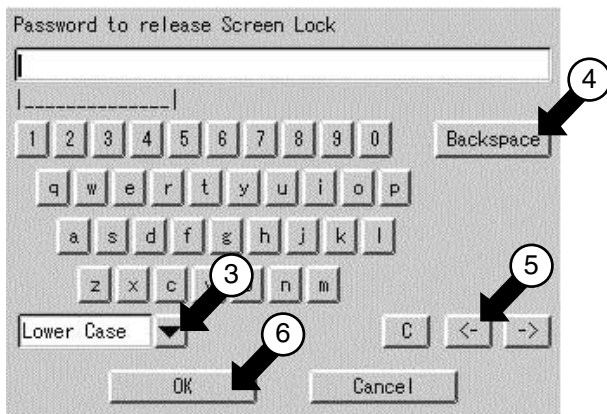

Lock and Unlock Operations on the Screen

You may use a password to lock and unlock operations on the screen.

To make this lock / unlock setting, you have to assign an unlock password on page 57 beforehand. The key mark in the following figure does not appear unless this setting is made.



Unlock icon

This icon indicates that operations on the screen have been unlocked.



Lock icon

This icon indicates that operations on the screen have been locked. In this state, you cannot manipulate the air conditioner or the system.

[Lock method]

1. While the unlock button is displayed, push the button ① to display the Confirmation Screen Screen 2.
2. Push Yes button ② to return to the Monitoring Screen Screen 1 with the operations locked.
Push No button not to lock the operations.

[Unlock method]

3. While the lock icon is displayed, push the button ①, Air conditioner Operation button or System Operation button to display the Password to release Screen Lock Screen 3.
4. Enter the password assigned for unlock password protection on page 57.

[Lock method]

- ③ : Toggle button for switching uppercase letters to lowercase letters
 - ④ : Correction button for characters
Backspace button to erase incorrect character(s).
 - ⑤ : Button for moving the cursor.
- After entering the password, push OK button ⑥.

To cancel the entered password, push Cancel button and return to the Monitoring Screen Screen 1.

System Settings Menu

The System Settings menu includes the following items:



System menu :





- Passwords
- Date/Time
- Backlight
- Zone / Group
- Locale
- Network
- Web Server
- Icon color
- Activation key input
- History
- Touch Panel Calibration
- Version Information

Automatic Control :



- Schedule
- Automatic Changeover
- Temperature Limit
- Heating Mode Optimization
- FC Change Over
- Alarm E-mail
- Simple Interlock







The following table describes the items mentioned above.

System Settings Menu Item	Description	Operation (Reference)
Passwords	<p>You can set passwords to restrict persons responsible for control operations.</p> <ol style="list-style-type: none"> 1. Assigning administrator passwords You may assign administrator passwords to restrict system menu operations. 2. Assigning unlock passwords You may assign unlock passwords to restrict air conditioner and system menu operations. <p>When both passwords have been assigned, you have to reset them twice to resume the system menu operations.</p> <p>Important: Be careful to retain the assigned passwords because if forgotten or lost you cannot perform system operations and must contact a dealer in your area. When you don't remember them, contact a dealer in your area.</p>	<p>See page</p> <p style="text-align: center;"> 64</p>
Date/Time	<p>Adjust the system clock (year, month, day, hour, minute and second). The clock is used for scheduled operation, saving history, power distribution (optional) and demand operation (optional).</p> <p>Note : Adjusting the clock may affect scheduled operation, power distribution or demand operation.</p> <p>For details of adjustment effects, read the following bullets, and for power distribution and demand operation refer to the instruction manual.</p> <p>Impact of changing the clock setting of a scheduled operation:</p> <ul style="list-style-type: none"> ● The operation scheduled to run at a time passed by advancing the clock is not performed. Ex.: When an air conditioner is scheduled to start at 10:00 (Ⓜ): If the time is adjusted to 10:05 at 9:55, <u>the scheduled operation</u> (Ⓜ) is not performed. ● The operation scheduled to run at a time reached again by turning back the clock is performed again. Ex.: When an air conditioner is scheduled to start at 10:00 (Ⓜ): If the time is adjusted to 9:55 at 10:05, <u>the scheduled operation</u> (Ⓜ) is performed again at 10:00. 	<p>See page</p> <p style="text-align: center;"> 65</p>

System Settings Menu Item	Description	Operation (Reference)
Backlight	<p>A backlight is used for the LCD of the intelligent Touch Controller. The backlight has its service life and the luminance of the backlight is reduced in proportion to the period of time it is illuminated. This setting is for preventing the luminance from being reduced in a short time by automatically turning the backlight OFF when the touch panel has been left untouched for a set period of time.</p> <p>If the backlight has been turned off automatically, touching the panel illuminates the backlight again.</p> <p>Backlight setting includes the following two steps :</p> <ol style="list-style-type: none"> 1.Set the time before the backlight is automatically turned OFF. Range : 1 - 60 minutes in increments of one minute. 2.Set whether the backlight should be automatically illuminated when any error is generated in the air conditioner while the backlight is turned OFF. Enable / Disable <p>NOTE: If this setting is not made, the backlight generally requires replacement every 3 - 4 years. The life of the backlight becomes even shorter if it is illuminated in a low temperature (50°F/10°C or lower) environment for a long time. When using the intelligent Touch Controller in a low temperature environment, it is recommended that a shorter time is set if above instruction #1., and disabled if #2.</p>	<p>See page</p> <p> 66</p>
Zone / Group	<p>Set the name, description, icons to be displayed and temperature setting limit (see Note) for the group.</p> <p>If this registration is not made, addresses for central management of the group is used for the Name and Description. Operation is not affected if these settings are not made.</p> <p>Addresses for central management include up to 64 addresses 1-00, 1-01, 1-15, 2-00, 4-15.</p> <p>During use of DIII plus adaptor, addresses are 128, 1:1-00 to 2:4-15.</p> <p>NOTE: The temperature setting limit is a function to allow operation only within the preset temperature limit to prevent too much cooling or heating. (The limit function above does not work when the operation mode of the air conditioners is Auto.)</p> <p>Ex.: Temperature setting limit : 68 - 90°F cooling If the temperature is set to 68°F with the remote control, the intelligent Touch Controller automatically changes the temperature setting to 77°F.</p>	<p>See page</p> <p> 67</p>
	<p>Set the name, description, icons to be displayed and sequential starting of the groups registered for a zone (see Note), and groups to be registered for the zone. The zone includes Collective, for which all groups are registered in advance. This zone is made available for making the settings for all of the air conditioners connected to the intelligent Touch Controller. The name, description or registered groups cannot be changed for this Collective zone.</p> <p>NOTE: Setting sequential starting of groups registered for the zone</p> <p>When multiple groups are registered for a zone and operation is performed by the zone, air conditioner outdoor units start operation at one time. If many outdoor units start at the same time, a large amount of current is used momentarily, which may trip the breaker when the power capacity of the receiving device is not enough. This setting is a function to prevent such phenomenon by starting air conditioners one by one.</p> <p>MEMO 1: When power distribution (optional) is performed, the zone registered here becomes the unit for distribution (tenant). Register the zone setting by the tenant.</p> <p>MEMO 2: One group can be registered for more than one zone.</p>	<p>See pages</p> <p> 68 to  69</p>

System Settings Menu Item	Description	Operation (Reference)
Locale	<p>This menu permits you to select a language from the list displayed on the intelligent Touch Controller.</p> <p>By setting locale, you can display data in the selected language on the intelligent Touch Controller.</p>	<p>See page 69</p>
Network	<p>This menu permits you to set an IP address for the intelligent Touch Controller.</p> <p>REMARKS: When using a Web function (option), you have to set the IP address, subnet mask, etc. according to the environmental requirements of your system.</p>	<p>See page 70</p>
Web Server	<p>This menu permits you to set the Port number of intelligent Touch Controller.</p> <p>REMARKS: When using Web software (option), you can set Web server. Set according to the environment requirements of your system.</p> <p>Setting of the Port number makes unable to access Web server by usual http address. Setting of the Port number also protects Web server from Port scan etc. and leads to make firm the security.</p> <p>EXAMPLE:</p> <div data-bbox="389 919 1020 1027" data-label="Diagram"> </div> <p>* When using usual http address of your PC's IP address (Port number 80), you can not access because the Port number of intelligent Touch Controller is 8081. You have to set either the Port number of your PC to 8081 or that of intelligent Touch Controller to default value 80 to access. Setting range of the Port number of intelligent Touch Controller is 1024-86635.</p>	<p>See page 71</p>
Icon Color	<p>This menu permits you to change the icon colors on the intelligent Touch Controller.</p> <p>Icons on the monitoring screen are displayed in the colors set on this menu.</p>	<p>See page 72</p>
Activation Key Input	<p>You have to input the activation key to use various options of the intelligent Touch Controller.</p> <p>If necessary, you can check the current license or add the new license. This setting is usually done by sales engineer of our company.</p>	<p>See page 73</p>

System Settings Menu Item	Description	Operation (Reference)																																																																	
Setting Schedule Outline	<p>This menu permits you to make settings for the scheduled operations in units of zones or groups. The scheduled operations are used to automatically start or stop an air conditioner at the date and time (year, month, day, day of the week, hour and minute) previously set in the intelligent Touch Controller according to the operating conditions of the air conditioner.</p> <p>The following operations can be scheduled and controlled.</p> <ul style="list-style-type: none"> ● Start/stop ● Remote control enabled/disabled ● Operation mode ● Temperature setting ● Ventilation mode (*) ● Ventilation volume (*) <p>* Note that these settings cannot be made depending on the model in use.</p> <p>The following describes a procedure for setting the schedule.</p> <ul style="list-style-type: none"> ● 17 kinds of dates can be registered including the weekly settings (Sunday to Saturday) and special settings (Ex1 to Ex10). These 17 kinds of dates are registered via following Setting Calendar menu. When registering them in setting calendar, you can register 11 kinds of dates including one weekly setting (because settings from Sunday to Saturday are used as a single setting) and 10 special settings (Ex1 to Ex10). ● Calendar settings, weekly settings and special settings can be made. EXAMPLE: The weekly settings are made for regular use and special settings are made for summer holiday.→These settings can be made for the coming 13 months. ● Lastly, concrete events can be registered on the respective 17 kinds of dates for which 7 weekly settings (Sunday to Saturday) and 10 special settings (Ex1 to Ex10) have been made. EXAMPLE: Setting for starting zone 1 at 9:00 and stopping it at 17:00→ A maximum of 16 operations can be registered for each date. ● A maximum of 8 schedules can be registered when the above settings are handled as a single schedule. 																																																																		
<p>The following describes how to make the settings, showing a few examples.</p>																																																																			
Setting Zone	<p>1. [Utilization of floors]</p> <p>1F : Reception Register "1F" as a zone name. 2F : Office Register "2F" as a zone name. 3F : Canteen Register "3F" as a zone name.</p>	<p>See page  68</p>																																																																	
Schedule Setting Calendar	<p>2. [Make the weekly and special settings on the setting calendar menu for the above zones]</p> <table border="1" data-bbox="310 1238 1105 1831"> <thead> <tr> <th colspan="2" data-bbox="310 1238 509 1290">Zone name</th> <th data-bbox="513 1238 707 1290">Zone 1F</th> <th data-bbox="712 1238 906 1290">Zone 2F</th> <th data-bbox="911 1238 1105 1290">Zone 3F</th> </tr> <tr> <th data-bbox="310 1290 509 1329">Day of the week</th> <th data-bbox="513 1290 707 1329"></th> <th data-bbox="712 1290 906 1329"></th> <th data-bbox="911 1290 1105 1329"></th> <th data-bbox="1109 1290 1304 1329"></th> </tr> </thead> <tbody> <tr> <td data-bbox="310 1329 509 1367">Sunday</td> <td data-bbox="513 1329 707 1367">Holiday</td> <td data-bbox="712 1329 906 1367">Holiday</td> <td data-bbox="911 1329 1105 1367">Holiday</td> <td data-bbox="1109 1329 1304 1367">Holiday</td> </tr> <tr> <td data-bbox="310 1367 509 1464">Monday</td> <td data-bbox="513 1367 707 1464">9:30 to 18:00: Working hours</td> <td data-bbox="712 1367 906 1464">8:30 to 17:00: Working hours 12:00 to 13:00: Lunch hour 17:00 to 22:00: Overtime 22:00: Locking</td> <td data-bbox="911 1367 1105 1464">9:30 to 14:30: Working hours</td> <td data-bbox="1109 1367 1304 1464"></td> </tr> <tr> <td data-bbox="310 1464 509 1503">Tuesday</td> <td data-bbox="513 1464 707 1503">Same as above</td> <td data-bbox="712 1464 906 1503">Same as above</td> <td data-bbox="911 1464 1105 1503">Same as above</td> <td data-bbox="1109 1464 1304 1503">Same as above</td> </tr> <tr> <td data-bbox="310 1503 509 1541">Wednesday</td> <td data-bbox="513 1503 707 1541">9:30 to 17:00: Working hours</td> <td data-bbox="712 1503 906 1541">Same as above</td> <td data-bbox="911 1503 1105 1541">Same as above</td> <td data-bbox="1109 1503 1304 1541">Same as above</td> </tr> <tr> <td data-bbox="310 1541 509 1580">Thursday</td> <td data-bbox="513 1541 707 1580">Same setting as for Monday</td> <td data-bbox="712 1541 906 1580">Same as above</td> <td data-bbox="911 1541 1105 1580">Same as above</td> <td data-bbox="1109 1541 1304 1580">Same as above</td> </tr> <tr> <td data-bbox="310 1580 509 1619">Friday</td> <td data-bbox="513 1580 707 1619">Same setting as for Monday</td> <td data-bbox="712 1580 906 1619">Same as above</td> <td data-bbox="911 1580 1105 1619">Same as above</td> <td data-bbox="1109 1580 1304 1619">Same as above</td> </tr> <tr> <td data-bbox="310 1619 509 1657">Saturday</td> <td data-bbox="513 1619 707 1657">holiday</td> <td data-bbox="712 1619 906 1657">holiday</td> <td data-bbox="911 1619 1105 1657">holiday</td> <td data-bbox="1109 1619 1304 1657">holiday</td> </tr> <tr> <td data-bbox="310 1657 509 1696">EX1</td> <td data-bbox="513 1657 707 1696">Third Saturday in every month</td> <td data-bbox="712 1657 906 1696">Handled as a weekday for attendance</td> <td data-bbox="911 1657 1105 1696">Handled as a weekday for attendance</td> <td data-bbox="1109 1657 1304 1696">Handled as a weekday for attendance</td> </tr> <tr> <td data-bbox="310 1696 509 1734">EX2</td> <td data-bbox="513 1696 707 1734">August 1 to August 20 December 29 to January 4</td> <td data-bbox="712 1696 906 1734">holiday</td> <td data-bbox="911 1696 1105 1734">holiday</td> <td data-bbox="1109 1696 1304 1734">holiday</td> </tr> <tr> <td data-bbox="310 1734 509 1773">EX3</td> <td data-bbox="513 1734 707 1773">December 28</td> <td data-bbox="712 1734 906 1773">9:00 to 12:00: Working hours</td> <td data-bbox="911 1734 1105 1773">9:00 to 12:00: Working hours</td> <td data-bbox="1109 1734 1304 1773">holiday</td> </tr> <tr> <td data-bbox="310 1773 509 1831">EX4</td> <td data-bbox="513 1773 707 1831">January 5</td> <td data-bbox="712 1773 906 1831">10:00 to 15:00: Working hours</td> <td data-bbox="911 1773 1105 1831">9:00 to 12:00: Working hours 12:00 to 13:00: Lunch hour</td> <td data-bbox="1109 1773 1304 1831">9:30 to 14:30: Working hours</td> </tr> </tbody> </table>	Zone name		Zone 1F	Zone 2F	Zone 3F	Day of the week					Sunday	Holiday	Holiday	Holiday	Holiday	Monday	9:30 to 18:00: Working hours	8:30 to 17:00: Working hours 12:00 to 13:00: Lunch hour 17:00 to 22:00: Overtime 22:00: Locking	9:30 to 14:30: Working hours		Tuesday	Same as above	Same as above	Same as above	Same as above	Wednesday	9:30 to 17:00: Working hours	Same as above	Same as above	Same as above	Thursday	Same setting as for Monday	Same as above	Same as above	Same as above	Friday	Same setting as for Monday	Same as above	Same as above	Same as above	Saturday	holiday	holiday	holiday	holiday	EX1	Third Saturday in every month	Handled as a weekday for attendance	Handled as a weekday for attendance	Handled as a weekday for attendance	EX2	August 1 to August 20 December 29 to January 4	holiday	holiday	holiday	EX3	December 28	9:00 to 12:00: Working hours	9:00 to 12:00: Working hours	holiday	EX4	January 5	10:00 to 15:00: Working hours	9:00 to 12:00: Working hours 12:00 to 13:00: Lunch hour	9:30 to 14:30: Working hours	<p>See page  74</p>
Zone name		Zone 1F	Zone 2F	Zone 3F																																																															
Day of the week																																																																			
Sunday	Holiday	Holiday	Holiday	Holiday																																																															
Monday	9:30 to 18:00: Working hours	8:30 to 17:00: Working hours 12:00 to 13:00: Lunch hour 17:00 to 22:00: Overtime 22:00: Locking	9:30 to 14:30: Working hours																																																																
Tuesday	Same as above	Same as above	Same as above	Same as above																																																															
Wednesday	9:30 to 17:00: Working hours	Same as above	Same as above	Same as above																																																															
Thursday	Same setting as for Monday	Same as above	Same as above	Same as above																																																															
Friday	Same setting as for Monday	Same as above	Same as above	Same as above																																																															
Saturday	holiday	holiday	holiday	holiday																																																															
EX1	Third Saturday in every month	Handled as a weekday for attendance	Handled as a weekday for attendance	Handled as a weekday for attendance																																																															
EX2	August 1 to August 20 December 29 to January 4	holiday	holiday	holiday																																																															
EX3	December 28	9:00 to 12:00: Working hours	9:00 to 12:00: Working hours	holiday																																																															
EX4	January 5	10:00 to 15:00: Working hours	9:00 to 12:00: Working hours 12:00 to 13:00: Lunch hour	9:30 to 14:30: Working hours																																																															

System Settings Menu Item	Description	Operation (Reference)																																																																																																																																																												
Setting Scheduled Event	<p>3. [Set events for zone 2F.] NOTE: The following lists the events for reference. Change the settings according to the actual use conditions.</p> <p>Setting events for Monday to Friday</p> <table border="1"> <thead> <tr> <th>Time</th> <th>Target zone</th> <th>Start/stop</th> <th>Operation mode</th> <th>Setting temperature</th> <th>Remote control code</th> </tr> </thead> <tbody> <tr> <td>8:30</td> <td>Zone 2F</td> <td>Start</td> <td>Disabled</td> <td>Disabled</td> <td>Assign priority to key pushed later</td> </tr> <tr> <td>12:00</td> <td>Zone 2F</td> <td>stop</td> <td>Disabled</td> <td>Disabled</td> <td>Disabled</td> </tr> <tr> <td>13:00</td> <td>Zone 2F</td> <td>Start</td> <td>Disabled</td> <td>Disabled</td> <td>Assign priority to key pushed later</td> </tr> <tr> <td>17:00</td> <td>Zone 2F</td> <td>Disabled</td> <td>Disabled</td> <td>Disabled</td> <td>Only stop operation permitted</td> </tr> <tr> <td>22:00</td> <td>Zone 2F</td> <td>stop</td> <td>Disabled</td> <td>Disabled</td> <td>Remote control operation prohibited</td> </tr> </tbody> </table> <p>Setting events for Saturday and Sunday</p> <table border="1"> <thead> <tr> <th>Time</th> <th>Target zone</th> <th>Start/stop</th> <th>Operation mode</th> <th>Setting temperature</th> <th>Remote control code</th> </tr> </thead> <tbody> <tr> <td>8:30</td> <td>Zone 2F</td> <td>Start</td> <td>Disabled</td> <td>Disabled</td> <td>Assign priority to key pushed later</td> </tr> <tr> <td>12:00</td> <td>Zone 2F</td> <td>stop</td> <td>Disabled</td> <td>Disabled</td> <td>Remote control operation prohibited</td> </tr> </tbody> </table> <p>Setting events for Ex1 (Third Saturday in every month)</p> <table border="1"> <thead> <tr> <th>Time</th> <th>Target zone</th> <th>Start/stop</th> <th>Operation mode</th> <th>Setting temperature</th> <th>Remote control code</th> </tr> </thead> <tbody> <tr> <td>8:30</td> <td>Zone 2F</td> <td>Start</td> <td>Disabled</td> <td>Disabled</td> <td>Assign priority to key pushed later</td> </tr> <tr> <td>12:00</td> <td>Zone 2F</td> <td>stop</td> <td>Disabled</td> <td>Disabled</td> <td>Disabled</td> </tr> <tr> <td>13:00</td> <td>Zone 2F</td> <td>Start</td> <td>Disabled</td> <td>Disabled</td> <td>Assign priority to key pushed later</td> </tr> <tr> <td>17:00</td> <td>Zone 2F</td> <td>Disabled</td> <td>Disabled</td> <td>Disabled</td> <td>Only stop operation permitted</td> </tr> <tr> <td>22:00</td> <td>Zone 2F</td> <td>stop</td> <td>Disabled</td> <td>Disabled</td> <td>Remote control operation prohibited</td> </tr> </tbody> </table> <p>Setting events for Ex2 (Summer holiday, etc.)</p> <table border="1"> <thead> <tr> <th>Time</th> <th>Target zone</th> <th>Start/stop</th> <th>Operation mode</th> <th>Setting temperature</th> <th>Remote control code</th> </tr> </thead> <tbody> <tr> <td>9:00</td> <td>Zone 2F</td> <td>Disabled</td> <td>Disabled</td> <td>Disabled</td> <td>Assign priority to key pushed later</td> </tr> <tr> <td>17:00</td> <td>Zone 2F</td> <td>stop</td> <td>Disabled</td> <td>Disabled</td> <td>Remote control operation prohibited</td> </tr> </tbody> </table> <p>Setting events for Ex3 (December 28)</p> <table border="1"> <thead> <tr> <th>Time</th> <th>Target zone</th> <th>Start/stop</th> <th>Operation mode</th> <th>Setting temperature</th> <th>Remote control code</th> </tr> </thead> <tbody> <tr> <td>12:00</td> <td>Zone 2F</td> <td>Start</td> <td>Heating</td> <td>77°F</td> <td>Assign priority to key pushed later Temperature setting prohibited Operation mode prohibited</td> </tr> <tr> <td>17:00</td> <td>Zone 2F</td> <td>stop</td> <td>Disabled</td> <td>Disabled</td> <td>Only stop operation permitted</td> </tr> </tbody> </table> <p>Setting events for Ex3 (December 28)</p> <table border="1"> <thead> <tr> <th>Time</th> <th>Target zone</th> <th>Start/stop</th> <th>Operation mode</th> <th>Setting temperature</th> <th>Remote control code</th> </tr> </thead> <tbody> <tr> <td>10:00</td> <td>Zone 2F</td> <td>Start</td> <td>Heating</td> <td>77°F</td> <td>Assign priority to key pushed later Temperature setting prohibited Operation mode prohibited</td> </tr> <tr> <td>12:00</td> <td>Zone 2F</td> <td>stop</td> <td>Disabled</td> <td>Disabled</td> <td>Only stop operation permitted</td> </tr> <tr> <td>13:00</td> <td>Zone 2F</td> <td>Start</td> <td>Disabled</td> <td>77°F</td> <td>Assign priority to key pushed later Temperature setting prohibited Operation mode prohibited</td> </tr> <tr> <td>15:00</td> <td>Zone 2F</td> <td>stop</td> <td>Disabled</td> <td>Disabled</td> <td>Only stop operation permitted</td> </tr> </tbody> </table> <p>* The term "Disabled" means that the setting is not changed</p>	Time	Target zone	Start/stop	Operation mode	Setting temperature	Remote control code	8:30	Zone 2F	Start	Disabled	Disabled	Assign priority to key pushed later	12:00	Zone 2F	stop	Disabled	Disabled	Disabled	13:00	Zone 2F	Start	Disabled	Disabled	Assign priority to key pushed later	17:00	Zone 2F	Disabled	Disabled	Disabled	Only stop operation permitted	22:00	Zone 2F	stop	Disabled	Disabled	Remote control operation prohibited	Time	Target zone	Start/stop	Operation mode	Setting temperature	Remote control code	8:30	Zone 2F	Start	Disabled	Disabled	Assign priority to key pushed later	12:00	Zone 2F	stop	Disabled	Disabled	Remote control operation prohibited	Time	Target zone	Start/stop	Operation mode	Setting temperature	Remote control code	8:30	Zone 2F	Start	Disabled	Disabled	Assign priority to key pushed later	12:00	Zone 2F	stop	Disabled	Disabled	Disabled	13:00	Zone 2F	Start	Disabled	Disabled	Assign priority to key pushed later	17:00	Zone 2F	Disabled	Disabled	Disabled	Only stop operation permitted	22:00	Zone 2F	stop	Disabled	Disabled	Remote control operation prohibited	Time	Target zone	Start/stop	Operation mode	Setting temperature	Remote control code	9:00	Zone 2F	Disabled	Disabled	Disabled	Assign priority to key pushed later	17:00	Zone 2F	stop	Disabled	Disabled	Remote control operation prohibited	Time	Target zone	Start/stop	Operation mode	Setting temperature	Remote control code	12:00	Zone 2F	Start	Heating	77°F	Assign priority to key pushed later Temperature setting prohibited Operation mode prohibited	17:00	Zone 2F	stop	Disabled	Disabled	Only stop operation permitted	Time	Target zone	Start/stop	Operation mode	Setting temperature	Remote control code	10:00	Zone 2F	Start	Heating	77°F	Assign priority to key pushed later Temperature setting prohibited Operation mode prohibited	12:00	Zone 2F	stop	Disabled	Disabled	Only stop operation permitted	13:00	Zone 2F	Start	Disabled	77°F	Assign priority to key pushed later Temperature setting prohibited Operation mode prohibited	15:00	Zone 2F	stop	Disabled	Disabled	Only stop operation permitted	See pages  75 to  77
Time	Target zone	Start/stop	Operation mode	Setting temperature	Remote control code																																																																																																																																																									
8:30	Zone 2F	Start	Disabled	Disabled	Assign priority to key pushed later																																																																																																																																																									
12:00	Zone 2F	stop	Disabled	Disabled	Disabled																																																																																																																																																									
13:00	Zone 2F	Start	Disabled	Disabled	Assign priority to key pushed later																																																																																																																																																									
17:00	Zone 2F	Disabled	Disabled	Disabled	Only stop operation permitted																																																																																																																																																									
22:00	Zone 2F	stop	Disabled	Disabled	Remote control operation prohibited																																																																																																																																																									
Time	Target zone	Start/stop	Operation mode	Setting temperature	Remote control code																																																																																																																																																									
8:30	Zone 2F	Start	Disabled	Disabled	Assign priority to key pushed later																																																																																																																																																									
12:00	Zone 2F	stop	Disabled	Disabled	Remote control operation prohibited																																																																																																																																																									
Time	Target zone	Start/stop	Operation mode	Setting temperature	Remote control code																																																																																																																																																									
8:30	Zone 2F	Start	Disabled	Disabled	Assign priority to key pushed later																																																																																																																																																									
12:00	Zone 2F	stop	Disabled	Disabled	Disabled																																																																																																																																																									
13:00	Zone 2F	Start	Disabled	Disabled	Assign priority to key pushed later																																																																																																																																																									
17:00	Zone 2F	Disabled	Disabled	Disabled	Only stop operation permitted																																																																																																																																																									
22:00	Zone 2F	stop	Disabled	Disabled	Remote control operation prohibited																																																																																																																																																									
Time	Target zone	Start/stop	Operation mode	Setting temperature	Remote control code																																																																																																																																																									
9:00	Zone 2F	Disabled	Disabled	Disabled	Assign priority to key pushed later																																																																																																																																																									
17:00	Zone 2F	stop	Disabled	Disabled	Remote control operation prohibited																																																																																																																																																									
Time	Target zone	Start/stop	Operation mode	Setting temperature	Remote control code																																																																																																																																																									
12:00	Zone 2F	Start	Heating	77°F	Assign priority to key pushed later Temperature setting prohibited Operation mode prohibited																																																																																																																																																									
17:00	Zone 2F	stop	Disabled	Disabled	Only stop operation permitted																																																																																																																																																									
Time	Target zone	Start/stop	Operation mode	Setting temperature	Remote control code																																																																																																																																																									
10:00	Zone 2F	Start	Heating	77°F	Assign priority to key pushed later Temperature setting prohibited Operation mode prohibited																																																																																																																																																									
12:00	Zone 2F	stop	Disabled	Disabled	Only stop operation permitted																																																																																																																																																									
13:00	Zone 2F	Start	Disabled	77°F	Assign priority to key pushed later Temperature setting prohibited Operation mode prohibited																																																																																																																																																									
15:00	Zone 2F	stop	Disabled	Disabled	Only stop operation permitted																																																																																																																																																									
Change Schedule Name	<p>4. [Change a schedule name.] This function enables you to change the existing schedule name to an easy-to-understand schedule name.</p>	See page  78																																																																																																																																																												
Change Special Date Name	<p>5. [Change a special day name.] This function enables you to change the existing special holiday name to an easy-to-understand holiday name.</p>	See page  78																																																																																																																																																												
Enable or disable a schedule.	<p>6. [Enable or disable a schedule.] This function finally enables you to decide whether to enable or disable the setting made.</p>	See page  78																																																																																																																																																												
Other Schedule Functions	<p>7. [Convenient functions for setting a schedule]</p>	See pages  79 to  80																																																																																																																																																												

System Settings Menu Item	Description	Operation (Reference)
Automatic Changeover	<p>This function allows the optimal room temperature to be maintained without the users having to change the operation mode by automatically switching the air conditioner's operation mode (cooling or heating) according to the room temperature for locations where there are vast temperature differences between day and night.</p> <p>< Overview of Function ></p> <p>This function automatically switches the air conditioner's operation mode and set temperature in units of one (4) automatic cooling/heating switch group according to the following 3 parameters: (1) main set temperature, (2) main room temperature, and the difference between the set temperatures when in cooling and in heating operation (listed hereafter as (3) temperature difference).</p> <p>[1] Control Method (How to determine the (1) Main Set Temperature and (2) Main Room Temperature)</p> <p>The 3 following methods exist for determining the above temperatures.</p> <p>1.Fixed Air Conditioner Method</p> <p>The first indoor unit (the one highest on the screen) among those registered in the automatic cooling / heating switch group is designated the main indoor unit and the set temperature and room temperature of that indoor unit are designated the main set temperature and main room temperature.</p> <p>Note that if the main indoor unit is in fan operation mode, its automatic cooling / heating switch group cannot be controlled.</p> <p>2.Operating Air Conditioner Selection Method</p> <p>Starting with the first indoor unit (the one highest on the screen) of those registered in the automatic cooling / heating switch group and working down, a search is performed to find an indoor unit that is both operating and in either cooling, heating, or automatic operation mode. The first one that satisfies both of these conditions is designated the main indoor unit and the set temperature and room temperature of that indoor unit are designated the main set temperature and main room temperature.</p> <p>If none is found that satisfies these conditions, the main set temperature and main room temperature are determined using the Fixed Air Conditioner Method shown above.</p> <p>3.Average Method</p> <p>All the indoor units that are registered in the automatic cooling / heating switch group, are operating, and are either in cooling, heating, or automatic mode are found, and the averages for their set temperatures and room temperatures are calculated and used as the main set temperature and main room temperature. (Decimals are rounded up.) Note that if there no air conditioners among the registered air conditioners for the averages to be calculated, the main set temperature and main room temperature are determined using the Fixed Air Conditioner Method shown above.</p> <p>[2] (3) Temperature Difference</p> <p>The temperature difference is the difference between the set temperatures when automatically switching between cooling and heating when using this control. The temperature difference is set to between 2°F and 13°F in 1°F units. (When shipped from the factory, the setting is 3°F.)</p> <p>[3] (4) Automatic Cooling / Heating Switch Group</p> <ul style="list-style-type: none"> ● This control is performed using one automatic cooling / heating switch group as a unit. ● Up to 128 indoor unit groups can be registered in one automatic cooling / heating switch group. ● It is not possible to register the same indoor unit to multiple automatic cooling / heating switch groups. ● Up to 128 automatic cooling / heating switch groups can be registered in this unit. ● These controls can be enabled and disabled for each individual automatic cooling / heating switch group. (These controls only work for groups set as enabled.) ● A mark indicating that the indoor unit is under automatic control will appear on the monitor screen. 	<p>See page</p> <p> 81</p>

System Settings
Menu Item

Description

Operation
(Reference)

Automatic
Changeover

< Control Implementation Conditions >

The relationship between the main room temperature, the main set temperature, and the operation mode is described below, with examples.

(Two examples are given, as the operation differs for temperature differences 3°F and below and 4°F and above.)

The controls are implemented when the control conditions are satisfied, every 5 minutes from the time the power is turned on.

< Implementation conditions when the temperature difference is 3°F or lower.>
(The figure below is for a temperature difference of 2°F)

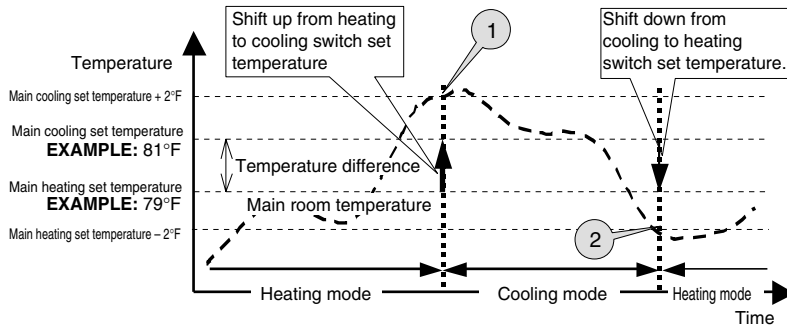

- ① Conditions for switching from heating to cooling :
Main room temperature > main set temperature + temperature difference + 2°F
EXAMPLE: 84°F > 79°F + 2°F + 2°F
- ② Conditions for switching from cooling to heating :
Main room temperature < main set temperature - temperature difference - 2°F
EXAMPLE: 76°F < 81°F - 2°F - 2°F

< Implementation conditions when the temperature difference is 4°F or higher.>
(The figure below is for a temperature difference of 4°F)

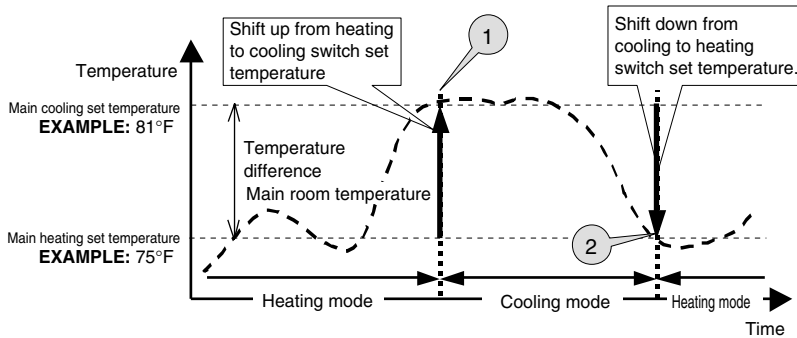

- ① Conditions for switching from heating to cooling :
Main room temperature > main set temperature + temperature difference
EXAMPLE: 82°F > 77°F + 4°F
- ② Conditions for switching from cooling to heating :
Main room temperature < main set temperature - temperature difference
EXAMPLE: 76°F < 81°F - 4°F

* See the next page for a detailed description of the instructions to the air conditioner.

See page

81

**System Settings
Menu Item**

Description

**Operation
(Reference)**

**Automatic
Changeover**

The control instruction is sent to the indoor units registered in the automatic cooling / heating switch group when the control implementation conditions shown on the previous page are fulfilled. The actual control instructions sent differ according to the control method setting (fixed air conditioner / operating air conditioner selection / average) and the fulfilled conditions such as to switch from cooling to heating. The control instructions for each situation are shown below.

See page



<Instructions sent to indoor units when control is implemented>

1. Fixed air conditioner/operating air conditioner selection methods

The control instructions are determined by the operation mode of the main indoor unit and the main set temperature. Instructions regarding the operation mode and the set temperature, shown below, are sent to all the indoor units registered in the group once all the control implementation conditions on the previous page are satisfied.

When conditions are met for switching from heating to cooling			
		Instructions to indoor units registered in the automatic cooling / heating switch group	
		Operation mode	Set temperature
Operation mode of the main indoor unit	Heating / Automatic heating	cooling	main unit setting temperature+temperature difference
	Cooling / Automatic cooling	cooling	main unit setting temperature
When conditions are met for switching from cooling to heating			
		Instructions to indoor units registered in the automatic cooling / heating switch group	
		Operation mode	Set temperature
Operation mode of the main indoor unit	Cooling / Automatic cooling	heating	main unit setting temperature-temperature difference
	Heating / Automatic heating	heating	main unit setting temperature

For this control, when the operation mode of the main indoor unit is automatic, whether it is automatic cooling mode or automatic heating mode is checked when judging the control conditions. Once the instructions have been determined, either a cooling or a heating instruction is sent to indoor units in automatic operation mode. (They switch from automatic to cooling or heating.)

2. Average Method

Unlike the fixed air conditioner and operating air conditioner selection methods, the set temperature is decided based on considerations of the current set temperature for each individual unit, without sending the same instruction based on the main indoor unit to all the air conditioners. When implementing the control, the following operation modes and set temperature instructions are executed.

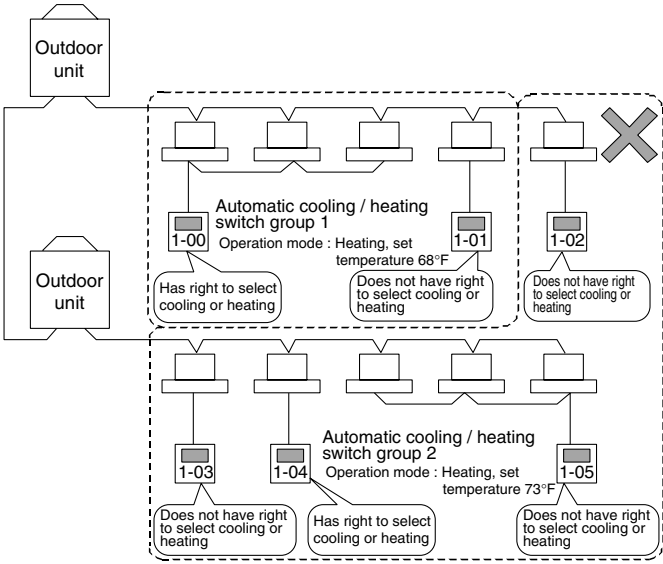

When conditions are met for switching from heating to cooling			
		Instructions to indoor units registered in the automatic cooling / heating switch group	
		Operation mode	Set temperature
Current indoor unit operation mode	Heating / Automatic heating	cooling	Current set temperature+temperature difference
	Cooling / Automatic cooling	No instruction	No instruction
	Other than the above	cooling	main unit setting temperature-temperature difference
When conditions are met for switching from cooling to heating			
		Instructions to indoor units registered in the automatic cooling / heating switch group	
		Operation mode	Set temperature
Current indoor unit operation mode	Cooling / Automatic cooling	heating	Current set temperature-temperature difference
	Heating / Automatic heating	No instruction	No instruction
	Other than the above	cooling	main unit setting temperature-temperature difference

System Settings Menu Item	Description	Operation (Reference)																																
Automatic Changeover	<p><Precautions when using this control></p> <p>1. ▲ CAUTION : Do not use the set temperature restriction function in indoor units which are subject to control. If it is used, operation modes will be switched and the set temperature will be changed repeatedly, possibly causing the air conditioners to break down.</p> <p>See page 44 for how to set the set temperature restriction function.</p> <p>2. The following will happen if a communication error (the icon on the screen is blue) occurs in the air conditioner being controlled.</p> <p>2-1. Fixed air conditioner If the main unit experiences a communication error, the automatic cooling / heating switch group control will not happen.</p> <p>2-2. Operating Air Conditioner Selection Method Remove the air conditioner experiencing the communication error from selection as the main unit, and select an air conditioner with normal communication.</p> <p>2-3. Average Method Remove the air conditioner experiencing the communication error from the calculation for the average, and only use air conditioners with normal communication for calculating the average.</p> <p>3. Control which matches the main unit's operation mode (Control for when the operation mode of the main unit does not represent the automatic cooling / heating switch group.) It is possible that only the operation mode for the main unit is changed when control using this function is done based on the main group unit (when the control method is fixed air conditioner or operating air conditioner). The following control is performed because it is possible that the operation mode of air conditioners other than the main unit in the group might be in violation of the purpose of control and not automatically switch if the conditions for implementing control using this function are not satisfied.</p> <p>EXAMPLE: Heating Mode-Matched Control When the main unit is already operating in heating mode, whether or not the conditions for implementing a switch from cooling to heating (main room temperature < main set temperature – temperature difference) depends on the state (environment) of the main unit. (If only the main unit is in heating operation, it is possible that the room temperature might not rise because of the indoor units other than the main unit which are in cooling operation, and the above control conditions might not be satisfied.) Therefore, only when control is performed based on the main group unit is the control below performed depending on the operation mode of the main group unit.</p> <p>Cooling Mode-Matched Control</p> <table border="1" data-bbox="358 1392 1064 1537"> <tr> <td colspan="2" rowspan="2"></td> <td colspan="2">Instructions to indoor units registered in the automatic cooling / heating switch group</td> </tr> <tr> <td>Operation mode</td> <td>Set temperature</td> </tr> <tr> <td colspan="2">State of main unit (control conditions)</td> <td rowspan="2">Cooling</td> <td rowspan="2">main set temperature</td> </tr> <tr> <td>Operation mode</td> <td>Cooling / Automatic cooling</td> </tr> <tr> <td>Temperature</td> <td>Main room temperature > main set temperature</td> <td></td> <td></td> </tr> </table> <p>Heating Mode-Matched Control</p> <table border="1" data-bbox="358 1576 1064 1721"> <tr> <td colspan="2" rowspan="2"></td> <td colspan="2">Instructions to indoor units registered in the automatic cooling / heating switch group</td> </tr> <tr> <td>Operation mode</td> <td>Set temperature</td> </tr> <tr> <td colspan="2">State of main unit (control conditions)</td> <td rowspan="2">Heating</td> <td rowspan="2">main set temperature</td> </tr> <tr> <td>Operation mode</td> <td>Heating / Automatic heating</td> </tr> <tr> <td>Temperature</td> <td>Main room temperature < main set temperature</td> <td></td> <td></td> </tr> </table>			Instructions to indoor units registered in the automatic cooling / heating switch group		Operation mode	Set temperature	State of main unit (control conditions)		Cooling	main set temperature	Operation mode	Cooling / Automatic cooling	Temperature	Main room temperature > main set temperature					Instructions to indoor units registered in the automatic cooling / heating switch group		Operation mode	Set temperature	State of main unit (control conditions)		Heating	main set temperature	Operation mode	Heating / Automatic heating	Temperature	Main room temperature < main set temperature			<p>See page</p> <p></p>
				Instructions to indoor units registered in the automatic cooling / heating switch group																														
		Operation mode	Set temperature																															
State of main unit (control conditions)		Cooling	main set temperature																															
Operation mode	Cooling / Automatic cooling																																	
Temperature	Main room temperature > main set temperature																																	
		Instructions to indoor units registered in the automatic cooling / heating switch group																																
		Operation mode	Set temperature																															
State of main unit (control conditions)		Heating	main set temperature																															
Operation mode	Heating / Automatic heating																																	
Temperature	Main room temperature < main set temperature																																	

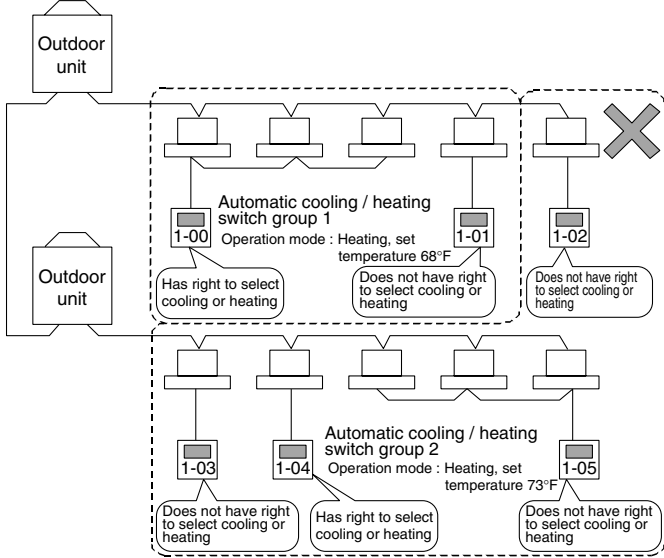

System Settings Menu Item	Description	Operation (Reference)
Automatic Changeover	<p>4. Because this control automatically switches the operation mode, if the air conditioner is not a cooling / heating free unit, <u>always register indoor units which have the right to select cooling or heating for the same cooling system to the same automatic cooling / heating switch group, when controlling indoor units which do not have such rights.</u></p> <p>Unexpected things may happen if control is done using the following incorrect automatic cooling / heating switch group settings.</p>  <p>If indoor units (address 1-02) which do not have the right to select cooling or heating for the same cooling system are not registered to the same automatic cooling / heating switch group, address 1-02 will behave in the following way.</p> <p>[Actions related to operation mode] If the room temperature of Group 1 rises, <u>group 1 will switch to cooling as per this control and the set temperature will become 77°F (if the temperature difference is 9°F).</u> When this happens, <u>the set temperature of the indoor unit at 1-02 will continue at 73°F although only the operation mode will change to cooling, i.e. in a different operation mode from the other indoor units in Group 2.</u> → <u>The operation mode will be determined by Group 1.</u></p> <p>[Actions regarding set temperature] If the room temperature of Group 2 rises, <u>group 2 will switch to cooling as per this control and the set temperature will become 82°F (if the temperature difference is 9°F).</u> When this happens, <u>the operation mode of the indoor unit at 1-02 will continue in heating and only the set temperature will change to 82°F, i.e. in a different operation mode from the other indoor units in Group 2.</u> → <u>The set temperature will be determined by Group 2.</u></p>	See page 81

System Settings Menu Item	Description	Operation (Reference)
Temperature Limit	<p>This function automatically starts and stops air conditioners in order to prevent the room temperature of unmanned rooms from getting too high or too low. For example, This has the following advantages.</p> <ul style="list-style-type: none"> ● It prevents overheating of or condensation from forming on equipment which needs to be temperature controlled in unmanned rooms. ● It can also help buildings and not just individual rooms to preserve heat by preventing unmanned rooms from reaching extremes of temperature at night. <p><Overview of Function></p> <p>This function performs automatic control by monitoring the relationship between the set upper and lower limits and the room temperature (the air conditioner intake temperature) to prevent the set room temperature from exceeding those limits. This function starts and stops the air conditioners and changes the operation mode.</p> <ul style="list-style-type: none"> ● Cooling operation control (and stop control) Cooling operation is automatically started when the room temperature rises above the set upper temperature limit. The air conditioner is stopped once the room temperature falls sufficiently far below the upper temperature limit (upper temperature limit – 7°F or more) during cooling due to this control. ● Heating operation control (and stop control) Heating operation is automatically started when the room temperature falls below the set lower temperature limit. The air conditioner is stopped once the room temperature rises sufficiently far above the lower temperature limit (lower temperature limit + 7°F or more) during heating due to this control. <p>① : Controlled air conditioners</p> <ul style="list-style-type: none"> ● This controls auto-start and auto-stop for each air conditioner based on the temperature set for each room temperature limit control group. ● <u>This control is not applicable to air conditioners which are already operating, even if they are registered to the room temperature limit control group. (It is only applicable to stopped air conditioners.)</u> ● Up to 128 indoor groups can be registered in one room temperature limit control group. ● It is not possible to register the same indoor unit to multiple room temperature limit control groups. ● Up to 8 room temperature limit control groups can be registered in this unit. ● These controls can be enabled and disabled for each individual room temperature limit control group. (These controls only work for groups set as enabled.) ● A mark indicating that the indoor unit is under automatic control will appear on the monitor screen. <p>② : Upper room temperature limit</p> <ul style="list-style-type: none"> ● Upper and lower room temperature limit The upper and lower room temperature limits desired for automatic control. The settable range of upper and lower limits is as follows. <p>Upper limit : 90°F to 122°F in 1°F units. (The default is 97°F.) Lower limit : 36°F to 60°F in 1°F units. (The default is 59°F.)</p> <p>The temperature difference between the upper or lower limit and the room temperature when the air conditioner is in cooling operation control using this function is 7°F. In heating mode it is also 7°F to prevent hunting.</p>	<p>See page</p> <p></p>

System Settings Menu Item	Description	Operation (Reference)
Temperature Limit	<p>③ : Control Implementation Conditions The relationship between room temperature, upper / lower limit, and operation mode is shown below. The controls are implemented when the control conditions are satisfied, every 5 minutes from the time the power is turned on.</p> <p>This function performs stop control for cooling / heating operation and other operation controls to prevent excessive increase or decrease of the room temperature. The set values of room temperature upper / lower limit control group are used for the upper / lower limit values and other factors of this control. This control is not performed for the group of air conditioners to which this control is set invalid. The set temperatures of the air conditioners are not changed by this control.</p> <p>① Start condition of cooling operation : <u>Cooling operation is controlled when the room temperature is higher than the upper limit of room temperature and the unit is stopped.</u></p> <p>② Start condition of heating operation : <u>Heating operation is controlled when the room temperature is lower than the lower limit of room temperature and the unit is stopped.</u></p> <p>③ Stop condition : The air conditioners under cooling / heating control by this function stop when any of the following conditions are met.</p> <ul style="list-style-type: none"> ● During cooling operation “Room temperature is lower than the upper limit of room temperature – 7°F” or “Room temperature is lower than the cooling set temperature” ● During heating operation “Room temperature is higher than the lower limit of room temperature + 7°F” or “Room temperature is higher than the heating set temperature” 	See page 82

System Settings Menu Item	Description	Operation (Reference)
Temperature Limit	<p>④ : Precautions for the use of this control</p> <p>The operation modes are switched over automatically with this control. Therefore, if the air conditioners are not cooling / heating-free machines, and when an indoor unit without cooling / heating selection right is to be controlled, be sure to register an indoor unit with cooling / heating selection right in the same cooling system into the same room temperature upper / lower limit group.</p> <p>If the control is performed with a wrong setting of room temperature upper / lower limit control group as shown in the figure below, the following unexpected control will be performed.</p>  <p>As shown in the figure above, if an indoor unit (address 1-02) not having the cooling / heating selection right is not registered into the same room temperature upper / lower limit control group with an indoor unit having cooling / heating selection right in the same cooling system, the operation of the address 1-02 will be as follows.</p> <p>[Actions related to operation mode]</p> <p>When the room temperature of the group 1 rises, the operation mode of the group 1 is switched to cooling operation by this control, and the automatic operation continues. At this time, only the operation mode of the indoor unit 1-02 changes into cooling mode, and operates in the mode different from other indoor units.</p> <p>→The operation mode will be determined by Group 1.</p>	See page  82

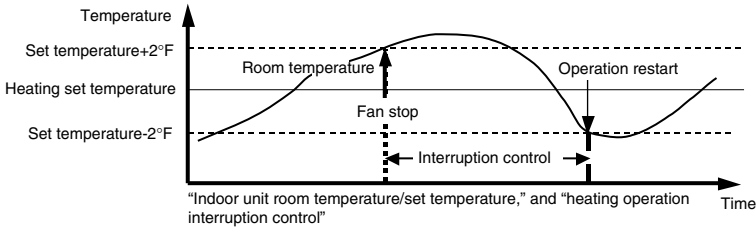
System Settings Menu Item	Description	Operation (Reference)
Heating Mode Optimization	<p>When operation in the heating mode, Daikin VRV systems continue to circulate a small volume of refrigerant gas through indoor unit that are in an acceptable condition (thermo-off). As the fan will continue to run at low speed or set speed, a rise in room temperature is possible.</p> <p>Therefore, this function starts / stops the air conditioner based on the room temperature (intake air temperature) and the set temperature during heating operation to prevent the temperature rise.</p> <p><Overview of Function></p> <ul style="list-style-type: none"> ● Operation interruption control When the room temperature for the air conditioner in heating operation becomes higher than the set temperature + 2°F, the air conditioner is stopped. However, because the stop control (operation interruption) by this function is the optimum control for turning off of the thermo-switch during heating operation, the system regards this status as in operation, and the screen display on the unit remains “In-operation.” *After the unit is interrupted by this function, it restarts when the specified conditions are met. Therefore the user’s explicit stop command is effective. ● Operation restart control When the room temperature for the air conditioner under the stop control by this function (during heating operation interruption) becomes lower than the set temperature – 2°F, the air conditioner is restarted. <p>① : Controlled air conditioners</p> <ul style="list-style-type: none"> ● This control is performed for each individual air conditioner. This function can be set to enabled / disabled for each air conditioner. ● Only the air conditioners with this function set to enabled becomes the subject for the control. ● For the indoor units under this control, a mark showing the automatic control is displayed on the monitoring screen. 	See page 

System Settings Menu Item	Description	Operation (Reference)
Heating Mode Optimization	<p>② : Control execution condition</p> <p>The relationship between room temperature, set temperature, and operation / stop status is shown in the figure below.</p> <p>The operation period of the control is every 5 minutes after the system power is turned on, and the operation is executed when the control conditions are met at each timing.</p>  <p>This function performs start / stop control based on the relationship between the set temperature and the room temperature (intake air temperature) of the air conditioner in heating operation. The control conditions are described below.</p> <p>Operation interruption control in heating mode (Stop control)</p> <p>When the room temperature for the air conditioner in heating operation becomes higher than the set temperature + 2°F, the air conditioner is stopped. The stoppage (operation interruption) by this control is processed as “in-operation of the air conditioner” on the monitoring screen of the unit.</p> <p>Operation restart control in heating mode (start control)</p> <p>When the room temperature for the air conditioner in interruption becomes lower than the set temperature – 2°F by this function, the air conditioner is restarted.</p> <p>Enabled-to-disabled Automatic Changeover control (start control)</p> <p>When the setting of this function for the air conditioner is changed from enabled to disabled during operation interruption, the operation is restarted.</p> <p>Operation mode Automatic Changeover control (Start control)</p> <p>When the operation mode of the air conditioner in interruption is changed by this function, the air conditioner is restarted.</p> <p>③ : Precautions for the use of this control</p> <ol style="list-style-type: none"> 1.The stoppage (operation interruption) by this control is processed as “in-operation of the air conditioner” on the monitoring screen of the unit. As a result, this status is indicated as “Stop” on the remote controller of the air conditioner, and as “In-operation” on the monitoring screen of the unit. 2.As explained above (item 1), because the display on the remote controller during operation interruption by this control is “Stop,” the user may not perform the stop operation even at the scheduled time of system stoppage, resulting in forget-to-stop error. Therefore, it is recommended that a measure against forget-to-stop error be executed by the scheduled control of the unit or other appropriate methods. 	See page 

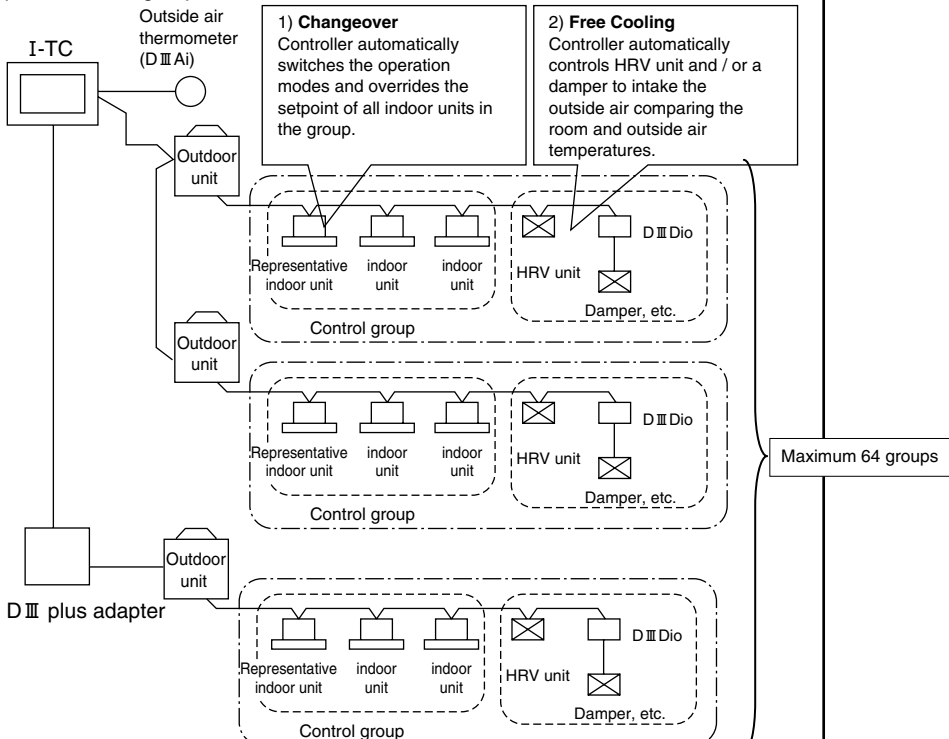
System Settings Menu Item	Description	Operation (Reference)
FC Change Over	<p>FC Change Over combines the functions of Changeover and Free Cooling to maintain the room temperature within a comfortable range while consuming minimal energy through the use of outside air. A comfortable range is configurable. FC Change Over replaces Automatic Changeover, Heating Mode Optimization functions and Setpoint Range limitation in the Group Settings. A DIII Ai unit is needed to sense the outside air temperature.</p> <p>[1] Features Overview The two functions provided by the FC Change Over are:</p> <p>(1) Changeover The Controller keeps the room temperature within a comfortable range by automatically switching the operation mode among Cool, Heat and Fan. The comfortable range is defined by the preset cooling setpoint (maximum temperature) and the preset heating setpoint (minimum temperature) which are both configured by the user. The preset cooling setpoint should be at least 2°C (4°F) above the preset heating setpoint.</p> <p>(2) Free Cooling The Controller reduces the cooling energy consumption by automatically controlling the ventilation equipment through the intake of outside air by the equipment. This outside air temperature should be lower than the room temperature. You can specify HRV and / or an air damper which is connected to a DIII Dio unit as the ventilation equipment.</p> <p>You can configure a control group of indoor units and ventilation equipment for FC Change Over up to 64 groups. Groups cannot overlap. Each group is controlled independently.</p> <p>You can specify the preset cooling and heating setpoints for each group and those setpoints will override the setpoint of all indoor units in the group. The changeover of the operation mode also affects all indoor units in the group, and is determined by the room temperature (return air temperature) of the representative indoor unit which you specified in the group.</p> 	<p>See page 84 to 88</p>

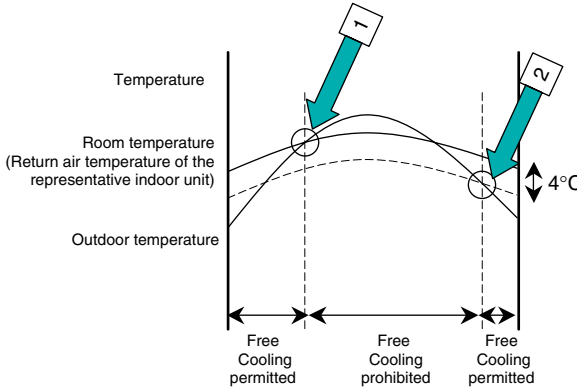
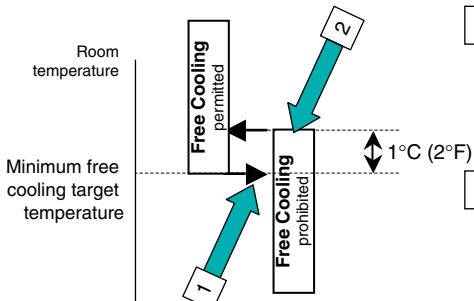

System Settings Menu Item	Description	Operation (Reference)																						
FC Change Over	<p>[2] Sequence of Operation</p> <p>(1) Changeover The Controller compares the room temperature to the preset cooling and heating setpoints. It automatically switches operation modes and overrides the setpoint of all indoor units in the group when the room temperature is outside of the range of the preset temperatures.</p> <p>When the room temperature is 1°C (2°F) higher than the preset cooling setpoint, the Controller switches to the Cool mode to maintain the room temperature. When the room temperature reaches the preset cooling setpoint in the Cool mode, the Controller switches to the Fan mode.</p> <p>Similarly, when the room temperature is 1°C (2°F) lower than the preset heating setpoint, the Controller switches to the Heat mode. When it reaches the preset heating setpoint in the Heat mode, the Controller will then switch the operation mode back to the Fan mode.</p> <p>The following chart illustrates this process. To follow the sequence of operation, refer to boxes 1 – 4 corresponding to the boxes with arrows on the chart.</p>	See page 84 to 88																						
	<table border="1" data-bbox="459 1188 1049 1275"> <tr> <td>Operation mode</td> <td>Cool</td> <td>Fan</td> <td>Cool</td> <td>Fan</td> <td>Cool</td> <td>Fan</td> <td>Heat</td> <td>Fan</td> <td>Heat</td> <td>Fan</td> </tr> <tr> <td>Setpoint</td> <td>T1</td> <td></td> <td>T1</td> <td></td> <td>T1</td> <td></td> <td>T2</td> <td></td> <td>T2</td> <td></td> </tr> </table>	Operation mode	Cool	Fan	Cool	Fan	Cool	Fan	Heat	Fan	Heat	Fan	Setpoint	T1		T1		T1		T2		T2		
Operation mode	Cool	Fan	Cool	Fan	Cool	Fan	Heat	Fan	Heat	Fan														
Setpoint	T1		T1		T1		T2		T2															
	<ol style="list-style-type: none"> 1 Room temperature reaches the preset cooling setpoint in cooling operation. Controller switches operation mode from Cool to Fan. 2 Operation mode is Fan. Room temperature rises to 1°C (2°F) above the preset cooling setpoint. Controller switches the operation mode to Cool. 3 Operation mode is Fan. Room temperature reaches 1°C (2°F) below preset heating setpoint. Controller switches operation mode to Heat. 4 Room temperature reaches preset heating setpoint in the heating operation. Controller switches operation mode from Heat to Fan. 																							
	<p>Note: Every 5 minutes,</p> <ul style="list-style-type: none"> Room temperatures are evaluated by Controller for changeover. To maintain the room temperature within the predetermined comfortable range, a change to Cool or Heat mode happens when the room temperature goes outside the preset temperature range by 1°C (2°F) in either direction. To avoid frequent changeovers, a change from Cool or Heat mode to Fan happens after the room temperatures has been inside the range for 30 minutes. While it is in Cool or Heat mode, the Controller overrides the indoor unit setpoint with the preset cooling or heating setpoint respectively. 																							

System Settings Menu Item	Description	Operation (Reference)
FC Change Over	<p>(2) Free Cooling For free cooling, the controller automatically controls the ventilation equipment. In this case the HRV unit is set at the bypass mode and/or an outside air damper is opened to intake outside air.</p> <p>This sequence facilitates Free Cooling which happens when the outside air temperature is lower than the room temperature. To avoid over cooling, the controller stops intake of outside air when the room temperature reaches the minimum free cooling setpoint which is the intermediate temperature between the preset cooling and heating setpoints.</p> <p>The following two charts illustrate this process. The numbered arrows on the charts correspond to the numbered boxes providing explanations for the two graphs.</p> <p>1) Outside air temperature should be lower than the room temperature</p> <p>The outside air temperature must be 4°C (7°F) lower than the room temperature to allow the free cooling operation. Hereafter, when the outside air temperature reaches the indoor temperature, free cooling will be suspended.</p>  <p>1 Free cooling is prohibited when the outside air temperature rises above the room temperature.</p> <p>2 When the outdoor temperature decreases to 4°C (7°F) below the room temperature, Free cooling is permitted. The 4°C (7°F) temperature difference prevents frequent cycling of the free cooling operating sequence.</p> <p>2) Room temperature should be higher than the minimum free cooling temperature</p> <p>Free cooling is permitted while the room temperature is above the minimum free cooling target temperature which is the intermediate temperature between the preset cooling and heating setpoints.</p>  <p>1 When the room temperature decreases to the minimum free cooling temperature, Free cooling is prohibited.</p> <p>2 When the room temperature increases to 1°C (2°F) above the minimum free cooling temperature, Free cooling is permitted.</p>	See page 84 to 88

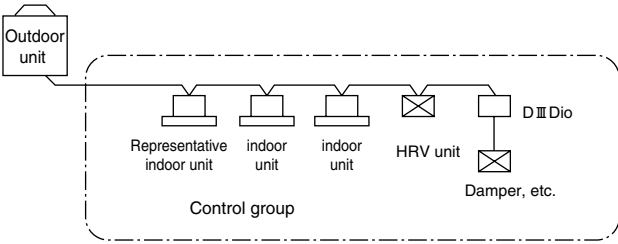

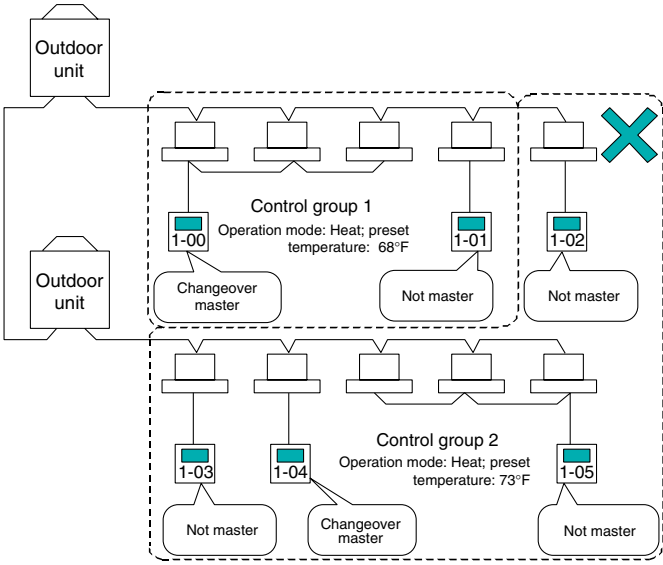

System Settings Menu Item	Description	Operation (Reference)																												
FC Change Over Minimum free cooling target temperature	<p>The illustration below shows the sequence of operation for Free Cooling.</p> <p>1) Outside air temp vs. Room temp</p> <table border="1" data-bbox="532 768 1064 938"> <tr> <td>P</td> <td>P</td> <td>N/P</td> <td>P</td> <td>P</td> <td>P</td> <td>P</td> </tr> <tr> <td>P</td> <td>N/P</td> <td>P</td> <td>P</td> <td>N/P</td> <td>P</td> <td>N/P</td> </tr> <tr> <td>ON (Open)</td> <td colspan="2">OFF (Close)</td> <td>ON</td> <td>OFF</td> <td>ON</td> <td>OFF</td> </tr> <tr> <td>Bypass</td> <td colspan="2">Total Heat Exchange (THE)</td> <td>Bypass</td> <td>THE</td> <td>Bypass</td> <td>THE</td> </tr> </table> <p>2) Room temp vs. Min temp</p> <p>Damper control</p> <p>HRV ventilation mode</p> <p>P: Free Cooling permitted N/P: not permitted</p> <p>During conditions where free cooling conditions which include Outside air temp vs. Room temp and Room temp vs. Min temp are permitted, the outside air would be introduced into the system.</p> <ol style="list-style-type: none"> Room temperature decreases to the minimum free cooling target temperature at which point free cooling would be prohibited. Although room temperature is satisfied 1°C (2°F) above the minimum free cooling setpoint, as outside air temperature increases above the room temperature, free cooling would be prohibited. Outside air temperature decreases to 4°C (7°F) below room temperature permitting free cooling operation. Outside air is then introduced by the HRV and/or outside air damper. Room temperature is satisfied at 1°C (2°F) above the minimum free cooling setpoint while outside air temperature remains lower than the room temperature therefore allowing free cooling operation. <p>NOTE: Every 5 minutes, the temperatures are evaluated for both conditions. Conditions that prohibit the use of outside air are processed without delay and free cooling immediately ceases however the opposite conditions which permit free cooling have to be satisfied for 30 minutes.</p>	P	P	N/P	P	P	P	P	P	N/P	P	P	N/P	P	N/P	ON (Open)	OFF (Close)		ON	OFF	ON	OFF	Bypass	Total Heat Exchange (THE)		Bypass	THE	Bypass	THE	See page 84 to 88
P	P	N/P	P	P	P	P																								
P	N/P	P	P	N/P	P	N/P																								
ON (Open)	OFF (Close)		ON	OFF	ON	OFF																								
Bypass	Total Heat Exchange (THE)		Bypass	THE	Bypass	THE																								

System Settings Menu Item	Description	Operation (Reference)
FC Change Over	<p>[3] Control Group Register units in the zone as a control group, and FC Change Over provides the individual control for the zone.</p> <ul style="list-style-type: none"> Control group  <p>The diagram illustrates a control group configuration. An outdoor unit is connected to a dashed-line box labeled 'Control group'. Inside this box, there are three indoor units: one labeled 'Representative indoor unit', and two others labeled 'indoor unit'. Additionally, there is an 'HRV unit' and a 'Damper, etc.' connected to the group. A 'D III Dio' sensor is also connected to the control group.</p> <ul style="list-style-type: none"> - Each control group is independently controlled. - Register all indoor units and ventilation equipment that is covered by a certain zone into the group. - Set the preset cooling setpoint and preset heating setpoint. You can enable and disable the control group. - Assign one indoor unit among those registered indoor units as the representative indoor unit for that group. The return air temperature of the representative indoor unit is used for FC Change Over as the room temperature in the zone. If the representative indoor unit utilizes a remote temperature sensor, the temperature at the sensor location is the reference temperature value. <ul style="list-style-type: none"> Configuring a comfortable temperature range for the control group <ul style="list-style-type: none"> - Preset the cooling setpoint (maximum temperature) and heating setpoint (minimum temperature) to conduct the Changeover . Determine the preset cooling and heating temperatures anywhere between 64°F and 86°F. The preset cooling setpoint should be 2°C (4°F) higher than the preset heating setpoint. 	<p>See page 84 to 88</p>

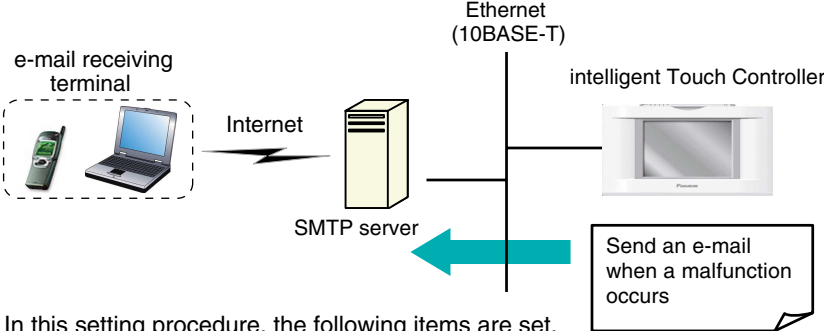

System Settings Menu Item	Description	Operation (Reference)
FC Change Over	<p>[4] Notes Read the following instructions to properly use the FC Change Over function.</p> <p>(1) Control group setting and cooling-heating Changeover To ensure that the changeover functionality of the control can switch the operating mode of the system, be sure to register indoor units that are not changeover masters in a control group along with the one that is the changeover master in the system.</p>  <p>Example of incorrect Changeover configuration. Specifically, when as shown in the above diagram an indoor unit which is not a changeover master (Address 1-02) was registered in Control Group 2 although it should have been registered in Control Group 1, the following unexpected action will occur:</p> <p>[Example: when the operation mode of Group 1 changes] As the room temperature in Group 1 increases, the operation mode of Group 1 switches over to Cool. At this time, the operation mode of the 1-02 indoor unit was turned to the same mode as that of the 1-00 unit. Consequently, only the 1-02 indoor unit in Group 2 was switched to a different mode from other indoor units in Group 2.</p> <p>[Example: when the operation mode of Group 2 changes] When the room temperature of Group 2 increases, the operation mode of Group 2 is turned to Cool. At this time, as the 1-02 indoor unit is consistent with the operation mode of the 1-00 indoor unit, only the 1-02 indoor unit in Group 2 stays in the original operation mode and is in a different mode from the others in Group 2.</p>	<p>See page 84 to 88</p>

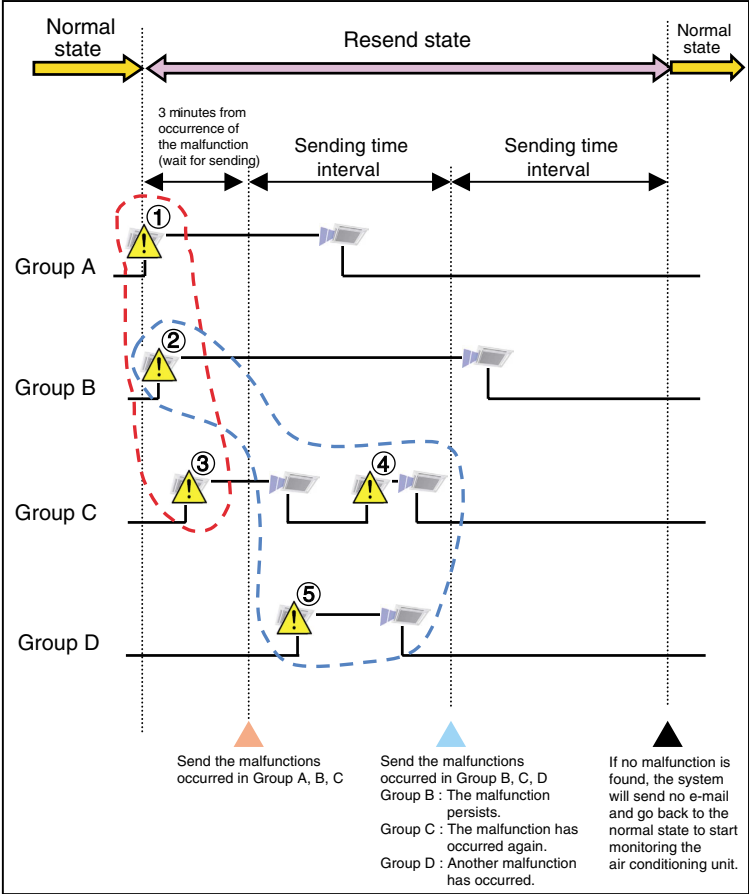

System Settings Menu Item	Description	Operation (Reference)
FC Change Over	<p>(2) Control sequence when the representative indoor unit is in off With the FC Change Over function, control is conducted by the return air temperature of the representative indoor unit (fixed) as the room temperature. In order for I-TC to reference the return air temperature of the representative indoor unit, the representative unit must be operating. Therefore, when the representative indoor unit is switched off, in a malfunction state, or communication error state, the FC Change Over function itself does not work.</p> <p>When any indoor units other than the representative indoor unit are off, in a malfunction or communication error state, FC Change Over will be conducted only with indoor units that are operating normally.</p> <p>(3) Selection of representative indoor unit Please do not assign the indoor unit where the room temperature changes often, e.g. near a window etc., as the representative indoor unit to prevent short cycling the FC Change Over sequence of operation.</p> <p>(4) When D III Ai is not connected The FC Change Over function uses the D III Ai to detect the outdoor temperature. When the D III Ai for outdoor temperatures is not connected to the system, has a failure, or is in communication error state, the FC Change Over function does not work.</p> <p>(5) Ventilation equipment When an isolation damper, for example, is used for ventilation control, it is necessary for it to be connected to the output of D III Dio. Applicable to HRV Type G and later.</p> <p>When no ventilation equipment is registered in a control group, only the Changeover sequence can be conducted.</p> <p>(6) Main and sub controller This function can work only in the main I-Touch Controller. It is not available in the sub I-Touch Controller.</p> <p>(7) The temperature display and the control operation Even if the room temperature display reaches the setpoint of the control, the control sequence might not be immediately executed because the temperature value is rounded to the tenth digit for display and the actual temperature may not have yet achieved the setpoint.</p>	See page  84 to  88



System Settings Menu Item	Description	Operation (Reference)																																	
<p>Alarm E-mail</p> <p>* The e-mail function is included in an option sold separately, where combined with the Web function.</p>	<p>This option is used to, when the intelligent Touch Controller detects a malfunction in such as the air conditioning unit (*1), send an e-mail containing the date, the error code and so on to the pre-registered administrators at three different addresses maximum.</p> <p>*1 : Where the malfunction refers a malfunction that occurs in the air conditioning unit or other facilities. When a communication error between the intelligent Touch Controller and the air-conditioning unit or other facilities occurs, no e-mail will be sent. If an air conditioning warning occurring during a test run is defined as a malfunction, an e-mail notification is sent.</p> <p>To use the e-mail function, the following equipment is required :</p> <ul style="list-style-type: none"> SMTP (Simple Mail Transfer Protocol) server <ul style="list-style-type: none"> a server which can transfer the e-mails complying with RFC821 e-mail receiving terminal <ul style="list-style-type: none"> a terminal which can receive the e-mails complying with RFC822 <p>The system configuration is drawn in the figure below :</p>  <p>In this setting procedure, the following items are set.</p> <table border="1" data-bbox="303 1083 1112 1798"> <thead> <tr> <th colspan="2">Item</th> <th>Description</th> </tr> </thead> <tbody> <tr> <td colspan="2">Validity/Invalidity of e-mail function</td> <td>Setting of Invalidity does not allow sending e-mails.</td> </tr> <tr> <td rowspan="5">SMTPServer</td> <td>SMTP Server Address</td> <td>Specifies URL (IPaddress) of the SMTP server.</td> </tr> <tr> <td>SMTP Server Port Number</td> <td>Specifies a port number of the SMTP server.</td> </tr> <tr> <td>Validity / Invalidity of [POP before SMTP] option</td> <td>Whether to access in advance the POP server specified before sending mail.</td> </tr> <tr> <td rowspan="3">Setting items when [POP before SMTP] is valid</td> <td>POP Server Address</td> <td>Specifies URL (IP address) of the POP server.</td> </tr> <tr> <td>POP Server Port Number</td> <td>Specifies a port number of the POP server.</td> </tr> <tr> <td>POP User ID</td> <td>User ID used for POP authentication</td> </tr> <tr> <td></td> <td>POP Password</td> <td>Pass word used for POP authentication</td> </tr> <tr> <td rowspan="3">Sending Conditions</td> <td>Sent-to Groups</td> <td>Specifies destination groups to which an e-mail will be sent at a time of malfunction.</td> </tr> <tr> <td>Sending Interval</td> <td>Specifies a time interval to retry sending an e-mail when the malfunction has not been cleared. (setting range : 1-72 hours, steps : one hour)</td> </tr> <tr> <td>ITC Identification Name</td> <td>Specifies a string of characters displayed in the Subject column when the e-mail is received.</td> </tr> <tr> <td>E-mail</td> <td>E-mail Address 1, 2, 3</td> <td>Specifies e-mail addresses Omissible</td> </tr> </tbody> </table>	Item		Description	Validity/Invalidity of e-mail function		Setting of Invalidity does not allow sending e-mails.	SMTPServer	SMTP Server Address	Specifies URL (IPaddress) of the SMTP server.	SMTP Server Port Number	Specifies a port number of the SMTP server.	Validity / Invalidity of [POP before SMTP] option	Whether to access in advance the POP server specified before sending mail.	Setting items when [POP before SMTP] is valid	POP Server Address	Specifies URL (IP address) of the POP server.	POP Server Port Number	Specifies a port number of the POP server.	POP User ID	User ID used for POP authentication		POP Password	Pass word used for POP authentication	Sending Conditions	Sent-to Groups	Specifies destination groups to which an e-mail will be sent at a time of malfunction.	Sending Interval	Specifies a time interval to retry sending an e-mail when the malfunction has not been cleared. (setting range : 1-72 hours, steps : one hour)	ITC Identification Name	Specifies a string of characters displayed in the Subject column when the e-mail is received.	E-mail	E-mail Address 1, 2, 3	Specifies e-mail addresses Omissible	<p>See pages 90 to 91</p>
Item		Description																																	
Validity/Invalidity of e-mail function		Setting of Invalidity does not allow sending e-mails.																																	
SMTPServer	SMTP Server Address	Specifies URL (IPaddress) of the SMTP server.																																	
	SMTP Server Port Number	Specifies a port number of the SMTP server.																																	
	Validity / Invalidity of [POP before SMTP] option	Whether to access in advance the POP server specified before sending mail.																																	
	Setting items when [POP before SMTP] is valid	POP Server Address	Specifies URL (IP address) of the POP server.																																
		POP Server Port Number	Specifies a port number of the POP server.																																
POP User ID		User ID used for POP authentication																																	
	POP Password	Pass word used for POP authentication																																	
Sending Conditions	Sent-to Groups	Specifies destination groups to which an e-mail will be sent at a time of malfunction.																																	
	Sending Interval	Specifies a time interval to retry sending an e-mail when the malfunction has not been cleared. (setting range : 1-72 hours, steps : one hour)																																	
	ITC Identification Name	Specifies a string of characters displayed in the Subject column when the e-mail is received.																																	
E-mail	E-mail Address 1, 2, 3	Specifies e-mail addresses Omissible																																	

System Settings Menu Item	Description	Operation (Reference)
<p>Alarm E-mail</p> <p>* The e-mail function is included in an option sold separately, where combined with the Web function.</p>	<p>Timing of E-mail Sending</p> <p>Referring to the figure below, timing of sending e-mails is described. [Send when a malfunction occurs in the normal state]</p> <p>If a malfunction occurs in the destination groups defined in the e-mail sending, wait three minutes from the malfunction (① in the figure below) before sending an e-mail.</p> <p>* An e-mail will not be sent immediately after the first malfunction. During the waiting time of three minutes, if another malfunction occurs in different groups (② or ③ in the figure below), one e-mail containing such multiple malfunctions will be sent.</p> <p>[Resend after sending once]</p> <p>As shown in case of Group B, if the malfunction persists even after the sending time interval from the first mail sending has elapsed, another e-mail will be sent.</p> <p>In the group for which the e-mail has been sent, after recovering from the malfunction, if another malfunction occurs again (⑤ in the figure below), the latest malfunction will be sent after the sending time interval will have elapsed.</p> <p>During the sending time interval, if a new malfunction occurs (④ in the figure below), an e-mail will be sent after the sending time interval will have elapsed.</p> <p>When the sending time interval has elapsed, if no malfunction is found in the groups, the system will move from the resend state to the normal state.</p> <p>* : The mark  represents occurrence of a malfunction and the mark  represents recovery from the malfunction.</p>  <p>The diagram illustrates the timing of e-mail sending across four groups (A, B, C, D) over time. It shows transitions between Normal state and Resend state. A 3-minute wait period follows a malfunction (①). Malfunctions in multiple groups (②, ③) trigger a single e-mail. Persistent malfunctions (④, ⑤) trigger subsequent e-mails. Recovery from a malfunction (⑥) returns the system to Normal state. Legend: Send malfunctions in Group A, B, C; Send malfunctions in Group B, C, D (B persists, C re-occurs, D new); No malfunction found, return to Normal state.</p> <p>Figure : Timing of E-mail Sending</p>	<p>See pages  to </p>

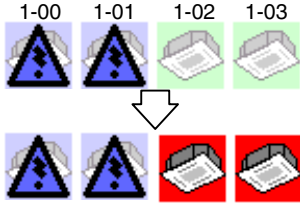
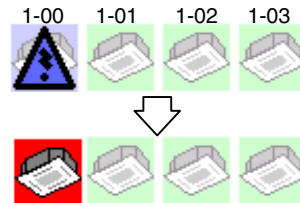
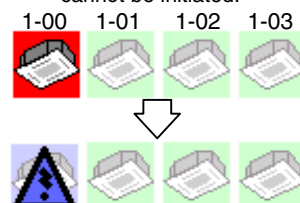

System Settings Menu Item	Description	Operation (Reference)
<p>Alarm E-mail</p> <p>* The e-mail function is included in an option sold separately, where combined with the Web function.</p>	<p>• Contents of E-mail The contents of the e-mail to be sent is described below. When three or more events of malfunctions have been occurred concurrently, <u>the latest two events are displayed in ascending order and the rest is represented just as the total number of such events.</u></p> <div data-bbox="300 459 1119 772" style="border: 1px solid black; padding: 5px;"> <p>From : <u>user012@daikin.co.jp</u> ← Originating e-mail address</p> <p>To : user012@daikin.co.jp ← Destination e-mail address</p> <p>Subject : Fault occurs (DAIKIN Head Office) ← Fixed string of characters and controller name</p> <p>04/02 14:11 Office A9 } ← Date of occurrence of the malfunction (month, day, hour, minute) in ascending order starting from the latest one, group name, error code</p> <p>04/02 14:10 ConfRoom E0 }</p> <p>Remaining mails : 1 ← Number of the remaining malfunctions except two indicated above when three or more malfunctions exist</p> </div> <p>• Operation when failing to send an e-mail When failing to send an e-mail, it will be resent three times at an interval of two minutes. Resending an e-mail will not be executed, however, in the following situations :</p> <ul style="list-style-type: none"> • The POP sever returned an error of user authentication. • The SMTP server returned a reply of a permanent failure. • A test run mail was sent. <p>• E-mail outgoing history The history file can contain a maximum number of 300 events of successes / failures in sending e-mails. * For details, refer to the History on Page 89.</p>	<p>See pages</p> <p>90 to 91</p>

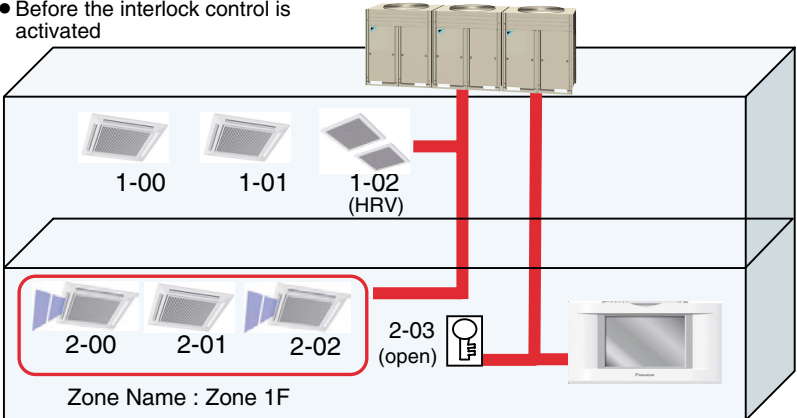
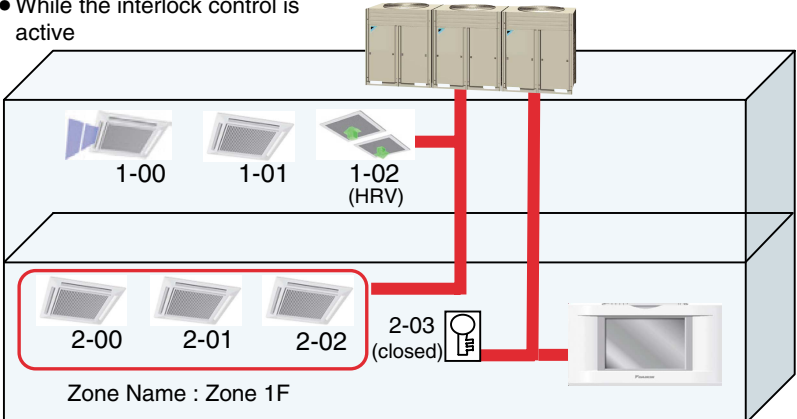

System Settings Menu Item	Description	Operation (Reference)
Simple Interlock	<p>This menu is used to make settings of an interlock control function in units of zones or groups.</p> <p>The simple interlock control is a function to automatically control groups or zones corresponding to a change of the operation states or the stop states in any groups.</p> <p>The settings of the simple interlock control are described below.</p> <ul style="list-style-type: none"> The simple interlock can store a maximum number of 128 program registrations. For each program, the following settings can be made : <ul style="list-style-type: none"> Interlock input point The target groups you want to monitor as the interlock input points (e.g. air conditioning unit, Di unit*, Dio unit*, HRV) are registered. *Monitoring is performed for the input states at the operation / stop connection point. In one program, the maximum number of 128 groups can be registered. Interlock output <i>Select conditions of interlock input points, Registration of control targets, and Settings of control details</i> are performed. Select condition of interlock input points The interlock control function is initiated when the groups specified as the interlock input points indicate the operation states described below. Select from (1)-(5) to specify the condition. (The control function is actually initiated when the state of the input point has changed.) <ol style="list-style-type: none"> No detection : Detection of inputs is not performed. (The control function is not effective.) Any one or more of the groups ON : When any one or more of the groups registered as the input points turn on, the control function is initiated. All ON : When all of the registered groups as the input points turn on, the control function is initiated. Any one or more of the groups OFF : When any one or more of the groups registered as the input points turn off to stop, the control function is initiated. All OFF : When all of the registered groups as the input points turn off to stop, the control function is initiated. <p>*1 Selecting "Any one or more of the groups ON (or OFF)" while some interlock input points are already ON (or OFF) will not initiate anew the interlock control function even when another interlock input point turns ON (or OFF). (Once the selected condition has become invalid and then, when the selected condition is satisfied again, the function can be initiated.)</p> <p>*2 When a communication error occurs in any of the interlock input points, the condition will be checked only for the interlock input points in the normal communication state.</p> Registration of control targets A single group or zone, which is to be controlled when the interlock condition is met, is registered. * If the interlock condition has been met during a communication error in the control target, the interlock control function will not be initiated even when the communication error is cleared. Settings of control details Details of the control operations for the target device where the interlock condition is met are defined. The available control operations are described below. Multiple operations can be set at a time. (Ex. : Start Command and Change Temperature Setting) <ul style="list-style-type: none"> Start / Stop commands Operation mode switching Change temperature setting Setting of permission / prohibition of hand-held remote controller operations (Start / Stop, Temperature setting, Operation mode switching) Ventilation mode switching (*) Ventilation amount switching (*) <p>* for HRV</p> <p>For one interlock program, two interlock outputs at the maximum can be specified.</p>	<p>See pages</p> <p> 92  94</p>

System Settings Menu Item	Description	Operation (Reference)																											
Simple Interlock	<p>Control operations when a communication error occurs in the interlock input points </p> <p>Example 1) When a communication error occurs in any of the interlock input points, the condition will be checked only for the interlock input points in the normal communication state.</p>  <p>When All ON is selected, the state change shown in the left figure can initiate the interlock control function.</p> <p>Example 2) Even if the interlock input point recovered from the communication error meets the specified condition, the interlock control function cannot be initiated.</p>  <p>When Any one or more of the groups ON is selected, the state change shown in the left figure cannot initiate the interlock control function.</p> <p>Example 3) When a communication error occurs in an interlock input point and, consequently, the specified condition is met, the interlock control function cannot be initiated.</p>  <p>Even when All OFF is selected, the state change shown in the left figure cannot initiate the interlock control function.</p> <p>Control operations when a communication error occurs in the control target equipment</p> <table border="0" data-bbox="312 1174 1108 1800"> <thead> <tr> <th></th> <th>interlock input point</th> <th>Control target equipment</th> <th>Condition of interlock input points :</th> </tr> <tr> <th></th> <th>1-00 1-01 1-02 1-03</th> <th>1-10</th> <th>All ON is selected.</th> </tr> </thead> <tbody> <tr> <td>(1)</td> <td></td> <td></td> <td>The condition of interlock input points is not met.</td> </tr> <tr> <td>(2)</td> <td></td> <td></td> <td>Although the condition of interlock input points is met, the communication error in the control target will not allow initiating the interlock control function.</td> </tr> <tr> <td>(3)</td> <td></td> <td></td> <td>Even when the control target recovers from the communication error, the interlock control function is not initiated.</td> </tr> <tr> <td>(4)</td> <td></td> <td></td> <td rowspan="2">In this case, once the condition of interlock input points has become invalid and then, when the condition is satisfied again, the interlock control function can be initiated.</td> </tr> <tr> <td>(5)</td> <td></td> <td></td> </tr> </tbody> </table>		interlock input point	Control target equipment	Condition of interlock input points :		1-00 1-01 1-02 1-03	1-10	All ON is selected.	(1)			The condition of interlock input points is not met.	(2)			Although the condition of interlock input points is met, the communication error in the control target will not allow initiating the interlock control function.	(3)			Even when the control target recovers from the communication error, the interlock control function is not initiated.	(4)			In this case, once the condition of interlock input points has become invalid and then, when the condition is satisfied again, the interlock control function can be initiated.	(5)			<p>See pages  to </p>
	interlock input point	Control target equipment	Condition of interlock input points :																										
	1-00 1-01 1-02 1-03	1-10	All ON is selected.																										
(1)			The condition of interlock input points is not met.																										
(2)			Although the condition of interlock input points is met, the communication error in the control target will not allow initiating the interlock control function.																										
(3)			Even when the control target recovers from the communication error, the interlock control function is not initiated.																										
(4)			In this case, once the condition of interlock input points has become invalid and then, when the condition is satisfied again, the interlock control function can be initiated.																										
(5)																													

System Settings Menu Item	Description	Operation (Reference)																														
Simple Interlock	<p>In the following section, utilization of the simple interlock control function is described while giving some examples. Referring to the figure below, the setting examples of the simple interlock control program are provided.</p> <p>[Example 1 of interlock control] When any of the air conditioning units on the second floor (1-00, 1-01) start operating, HRV (1-02) will be started. When all of the air conditioning units (1-00, 1-01) on the second floor stop, HRV (1-02) will be stopped.</p> <p>[Example 2 of interlock control] When the key of the first floor (2-03)* is locked, the air conditioning units (2-00 to 2-02) will be stopped and start/stop operations of the hand-held remote controller will be prohibited.</p> <p>*The mark  shown in the figure below represents a key. In this example, locking the key to the Di unit allows a closing (ON) connection point to be connected.</p> <ul style="list-style-type: none"> Before the interlock control is activated  <p style="text-align: center;">Air conditioning unit (1-00) in operation Di unit (2-03) locked</p> <ul style="list-style-type: none"> While the interlock control is active  <p>Settings for performing the control operations described above</p> <table border="1" data-bbox="308 1593 1118 1796"> <thead> <tr> <th rowspan="2">Interlock Program Number</th> <th rowspan="2">Interlock input point</th> <th colspan="3">Interlock Output 1</th> <th colspan="3">Interlock Output 2</th> </tr> <tr> <th>Input Condition</th> <th>Control Target</th> <th>Control Item</th> <th>Input Condition</th> <th>Control Target</th> <th>Control Item</th> </tr> </thead> <tbody> <tr> <td>Program 1 (two interlock operations)</td> <td>1-00 1-01</td> <td>Anyone or more of the groups ON</td> <td>1-02</td> <td>Start operation</td> <td>All OFF</td> <td>1-02</td> <td>Stop</td> </tr> <tr> <td>Program 2 (one interlock operations)</td> <td>2-03</td> <td>All ON</td> <td>Zone 1F</td> <td> <ul style="list-style-type: none"> Stop hand-held remote controller Prohibition of start/stop </td> <td>No detection</td> <td>-</td> <td>-</td> </tr> </tbody> </table>	Interlock Program Number	Interlock input point	Interlock Output 1			Interlock Output 2			Input Condition	Control Target	Control Item	Input Condition	Control Target	Control Item	Program 1 (two interlock operations)	1-00 1-01	Anyone or more of the groups ON	1-02	Start operation	All OFF	1-02	Stop	Program 2 (one interlock operations)	2-03	All ON	Zone 1F	<ul style="list-style-type: none"> Stop hand-held remote controller Prohibition of start/stop 	No detection	-	-	<p>See pages  92 to  94</p>
Interlock Program Number	Interlock input point			Interlock Output 1			Interlock Output 2																									
		Input Condition	Control Target	Control Item	Input Condition	Control Target	Control Item																									
Program 1 (two interlock operations)	1-00 1-01	Anyone or more of the groups ON	1-02	Start operation	All OFF	1-02	Stop																									
Program 2 (one interlock operations)	2-03	All ON	Zone 1F	<ul style="list-style-type: none"> Stop hand-held remote controller Prohibition of start/stop 	No detection	-	-																									

System Settings Menu Item	Description							Operation (Reference)																																																																										
Simple Interlock	<p>• Limitations of the simple interlock function In the simple interlock function, setting the inconsistent input/output conditions is allowed as described below. * Priority of the interlock programs is determined in such a way that the lower program has a higher priority and the output 2 has a higher priority than the output 1.</p> <p>Example 1) When the interlock input point and the control target are same</p> <table border="1" data-bbox="303 446 1112 562"> <thead> <tr> <th rowspan="2">Interlock Program Number</th> <th rowspan="2">Interlock input point</th> <th colspan="3">Interlock Output 1</th> <th colspan="3">Interlock Output 2</th> </tr> <tr> <th>Input Condition</th> <th>Control Target</th> <th>Control Item</th> <th>Input Condition</th> <th>Control Target</th> <th>Control Item</th> </tr> </thead> <tbody> <tr> <td>Program 1</td> <td>1-00</td> <td>Any one or more of the groups ON</td> <td>1-00</td> <td>Stop</td> <td>No detection</td> <td>-</td> <td>-</td> </tr> </tbody> </table> <p>Result : 1-00 cannot be initiated. (Even if it has been initiated, it should be stopped by the interlock control function.)</p> <p>Example 2) When the interlock input point and the control target are same but the control items specify opposite operations</p> <table border="1" data-bbox="303 678 1112 794"> <thead> <tr> <th rowspan="2">Interlock Program Number</th> <th rowspan="2">Interlock input point</th> <th colspan="3">Interlock Output 1</th> <th colspan="3">Interlock Output 2</th> </tr> <tr> <th>Input Condition</th> <th>Control Target</th> <th>Control Item</th> <th>Input Condition</th> <th>Control Target</th> <th>Control Item</th> </tr> </thead> <tbody> <tr> <td>Program 1</td> <td>1-00</td> <td>Any one or more of the groups ON</td> <td>1-01</td> <td>Start operation</td> <td>Any one or more of the groups OFF</td> <td>1-01</td> <td>Stop</td> </tr> </tbody> </table> <p>Result : The interlock output 2 with a higher priority is executed. (1-01 stops.)</p> <p>The settings of the input/output conditions as described in the example 3 below will cause a failure of the air conditioning unit; therefore never use these settings.</p> <p>Example 3) When the interlock input point and the control output fall into a loop</p> <table border="1" data-bbox="303 967 1112 1151"> <thead> <tr> <th rowspan="2">Interlock Program Number</th> <th rowspan="2">Interlock input point</th> <th colspan="3">Interlock Output 1</th> <th colspan="3">Interlock Output 2</th> </tr> <tr> <th>Input Condition</th> <th>Control Target</th> <th>Control Item</th> <th>Input Condition</th> <th>Control Target</th> <th>Control Item</th> </tr> </thead> <tbody> <tr> <td>Program 1</td> <td>1-00</td> <td>Any one or more of the groups ON</td> <td>1-01</td> <td>Start operation</td> <td>Any one or more of the groups OFF</td> <td>1-01</td> <td>Stop</td> </tr> <tr> <td>Program 2</td> <td>1-01</td> <td>Any one or more of the groups ON</td> <td>1-00</td> <td>Stop</td> <td>Any one or more of the groups OFF</td> <td>1-00</td> <td>Start operation</td> </tr> </tbody> </table> <div data-bbox="303 1180 1112 1653" style="text-align: center;"> </div> <p>Result : The interlock program is repeated endlessly. In the example above, the air conditioning units : 1-00 and 1-01 repeat start/stop operations endlessly.</p>							Interlock Program Number	Interlock input point	Interlock Output 1			Interlock Output 2			Input Condition	Control Target	Control Item	Input Condition	Control Target	Control Item	Program 1	1-00	Any one or more of the groups ON	1-00	Stop	No detection	-	-	Interlock Program Number	Interlock input point	Interlock Output 1			Interlock Output 2			Input Condition	Control Target	Control Item	Input Condition	Control Target	Control Item	Program 1	1-00	Any one or more of the groups ON	1-01	Start operation	Any one or more of the groups OFF	1-01	Stop	Interlock Program Number	Interlock input point	Interlock Output 1			Interlock Output 2			Input Condition	Control Target	Control Item	Input Condition	Control Target	Control Item	Program 1	1-00	Any one or more of the groups ON	1-01	Start operation	Any one or more of the groups OFF	1-01	Stop	Program 2	1-01	Any one or more of the groups ON	1-00	Stop	Any one or more of the groups OFF	1-00	Start operation	See pages 92 to 94
Interlock Program Number	Interlock input point	Interlock Output 1			Interlock Output 2																																																																													
		Input Condition	Control Target	Control Item	Input Condition	Control Target	Control Item																																																																											
Program 1	1-00	Any one or more of the groups ON	1-00	Stop	No detection	-	-																																																																											
Interlock Program Number	Interlock input point	Interlock Output 1			Interlock Output 2																																																																													
		Input Condition	Control Target	Control Item	Input Condition	Control Target	Control Item																																																																											
Program 1	1-00	Any one or more of the groups ON	1-01	Start operation	Any one or more of the groups OFF	1-01	Stop																																																																											
Interlock Program Number	Interlock input point	Interlock Output 1			Interlock Output 2																																																																													
		Input Condition	Control Target	Control Item	Input Condition	Control Target	Control Item																																																																											
Program 1	1-00	Any one or more of the groups ON	1-01	Start operation	Any one or more of the groups OFF	1-01	Stop																																																																											
Program 2	1-01	Any one or more of the groups ON	1-00	Stop	Any one or more of the groups OFF	1-00	Start operation																																																																											

System Settings Menu Item	Description	Operation (Reference)
Simple Interlock Change Name	[Change the name of the simple interlock program] You can customize the name of the simple interlock program, such as the name that reflects its functionality.	See page  94
Simple Interlock Validity / Invalidity Setting	[Determine the validity / invalidity of the simple interlock setting] Lastly, whether the simple interlock setting is valid or invalid can be specified. The program set to invalid will not run.	See page  94

System Settings Menu Item	Description	Operation (Reference)
History	This menu should be displayed on the screen stored in the memory of intelligent Touch Controller and used to store data in the memory card, which is field supplied.	See page  89
Touch Panel Calibration	Menu for adjusting the positions of buttons on the touch panel used as the screen of the intelligent Touch Controller. If repeatedly pressing a particular button on the screen does not activate operation, use this menu to calibrate the touch panel.	See page  90
Version information	This provides maintenance information. The menu shows the version number of the software for the intelligent Touch Controller currently used.	See page  95

System Settings Menu Operation

Screen 1 Monitoring Screen

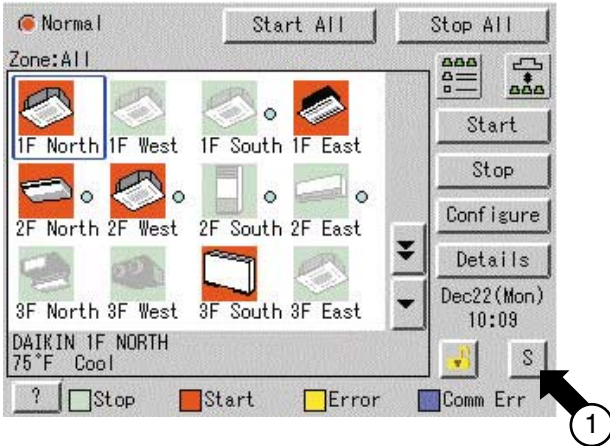

Screen 2 System Settings Menu

(A)System

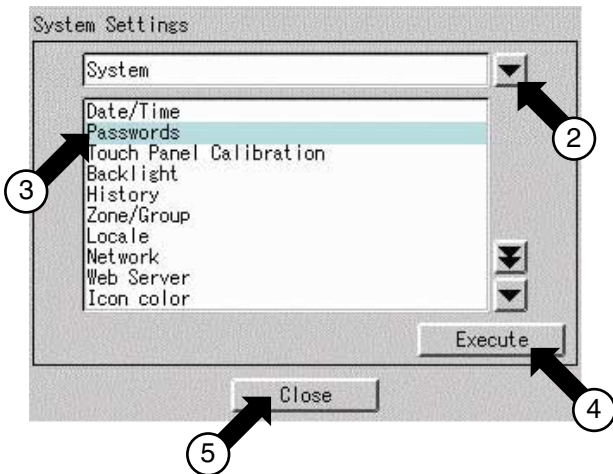

(B)Automatic Control

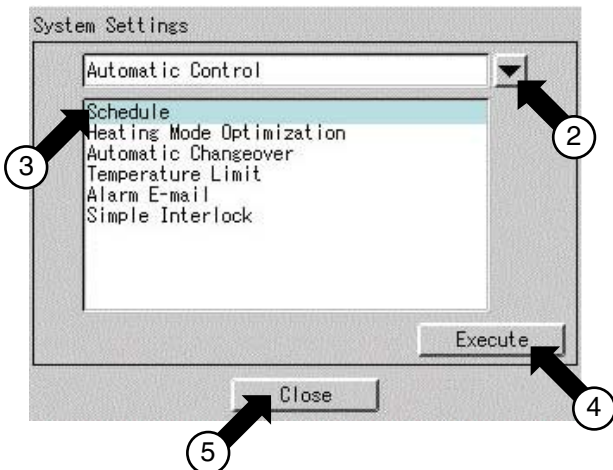

Viewing the System Settings Menu Screen

1. Press the [S] button ① on Screen 1 Monitoring.
2. Screen 2 System Settings (see lower left) appears.
If a password is set, the screen does not appear unless the password is entered.
3. Select an item from the System Settings Menu.
 - 3-1. Select an item from pull-down menu ②.
 - (A)System
 - (B)Automatic control
 - 3-2. Click the item to be set ③, and press the [Execute] button ④.
The example on the left shows the appearance of the screen for passwords.
 - 3-3. The setting screen selected appears.
 - 3-4. When the setting has been made on the setting screen, press [Close], [OK] or [Cancel].
Detailed operation is described in the following items.
 - 3-5. Screen 2 reappears. The setting selected is complete.
 - 3-6. If another item is to be set, repeat the operation in 3-1 - 3-5.
If there is no more item to be set, press the [Close] button ⑤.
Screen 1 Monitoring screen reappears.

The following pages describe the System Settings operation in order.

System Settings Menu Operation

Screen 1 Passwords

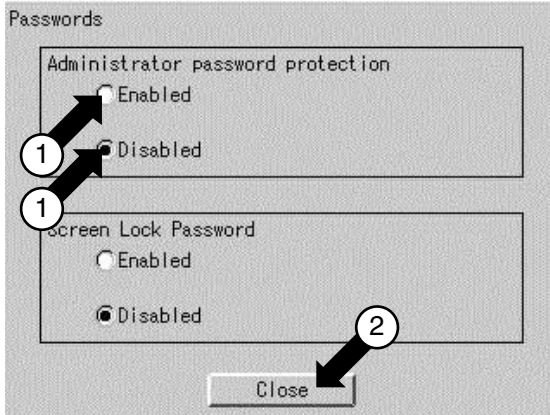

Screen 2 Enter Password

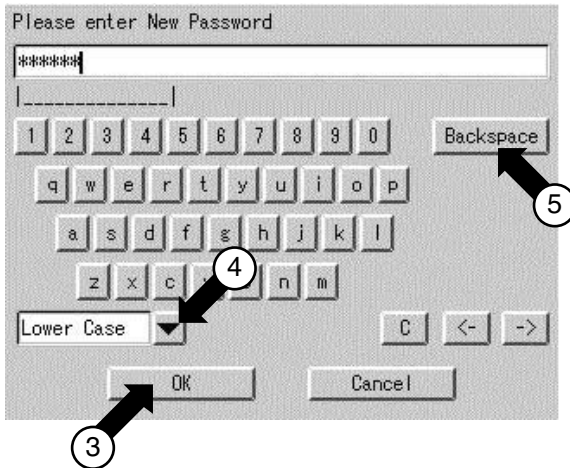

Screen 3 Passwords

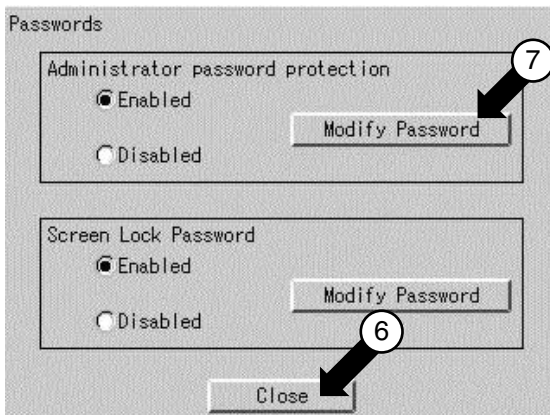

Passwords

1. Select **Passwords** at Screen 2(A) on page 63.
2. Screen 1 Passwords, which is shown on the left, appears.
3. Select **Enabled** or **Disabled** for password Protection ①.
If **Disabled** is selected, press the [Close] button ②. The setting is completed.
If **Enabled** is selected, Screen 2 Enter Password appears. Perform following operation in 4 to 7.
4. Use the keyboard on the panel to enter the password.
NOTE: Password is case-sensitive (see ④). Use caution and enter the exact password.
A password can be as long as 32 characters.
When a wrong character is entered by mistake, press the [Back Space] button ⑤.
5. When the setting has been made, press the [OK] button ③.
Pressing the [Cancel] button is equal to setting **Disabled** for Password Protection.
6. For confirmation, Please confirm Password screen appears. Enter the password as described in 4. Screen 3 appears.
7. Pressing the [Close] button ⑥ completes the setting.

MEMO: To change the password, press the [Modify Password] button ⑦ and repeat the operation in 4 - 7 above.

* Password setting is possible in the same way both in Administrator password protect and Screen Lock Password.

System Settings Menu Operation

Screen 1 Date/Time

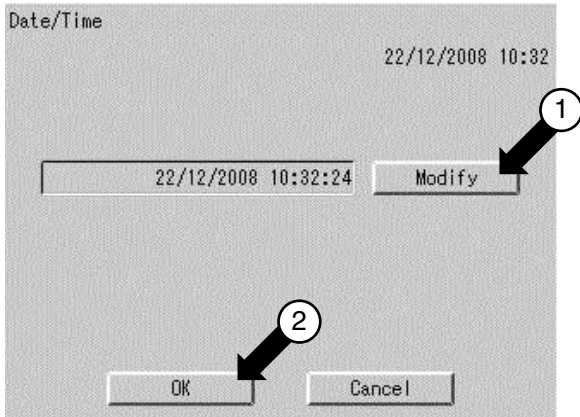

Screen 2 Time setting dialog

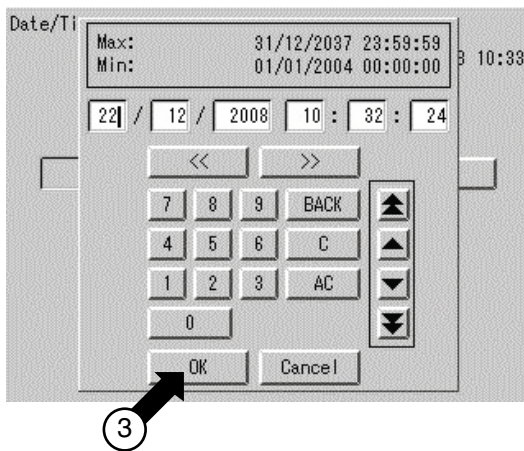

Screen 3 Confirmation

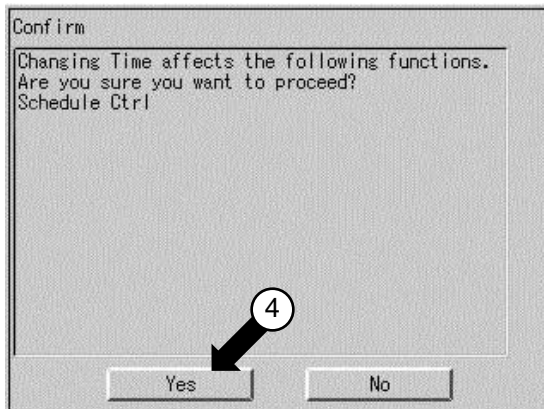

Date/Time

1. Select **Date/Time** at Screen2(A) on page 63.
2. Screen 1 Date/Time, which is shown on the left, appears. Press the [Modify] button ①. Time setting dialog in Screen2 is displayed.
3. Press the number key button to set the year, month, day, hour, minute and second.
4. When the setting has been made, press the [OK] button ③. Screen 3 Confirmation appears.
5. See the Note on page 32. If changing the time setting causes no problem, press the [Yes] button ④. Date/Time is complete. To cancel setting, press the [No] button.

System Settings Menu Operation

Screen 1 Backlight

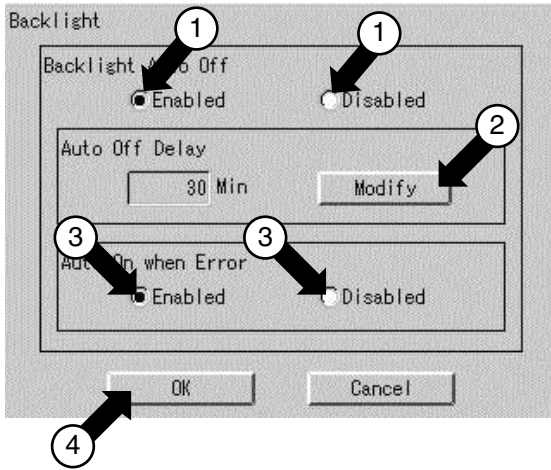

Backlight

1. Select **Backlight** at Screen 2(A) on page 63.
2. Screen 1 Backlight, which is shown on the left, appears.
3. Press **Enabled** or **Disabled** for Backlight Auto Off ①.
If you select Disabled, go to step 6.

Caution

For longer service life of the backlight, select **Enabled** whenever the backlight does not need to be illuminated all the time. The backlight once turned OFF is illuminated again when the panel is touched or automatically activated by any error generated in the air conditioner if **Enabled** is selected for 5. Auto On when Error.

4. Press the [Modify] button ②.
Input dialog is displayed.
Set the time for automatic OFF.
5. Set whether the backlight should be automatically turned ON when any error is generated in air conditioners by selecting **Enabled** or **Disabled** ③.
6. Press the [OK] button ④.
To cancel the setting, press the [Cancel] button.

System Settings Menu Operation

Screen 1 Zone/Group

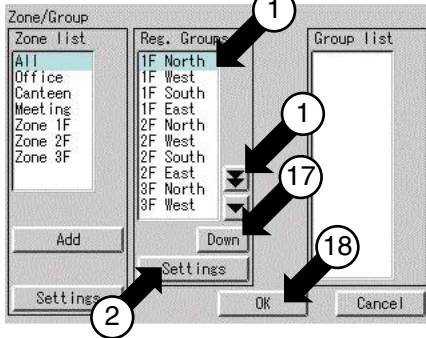

Screen 2 Group Settings

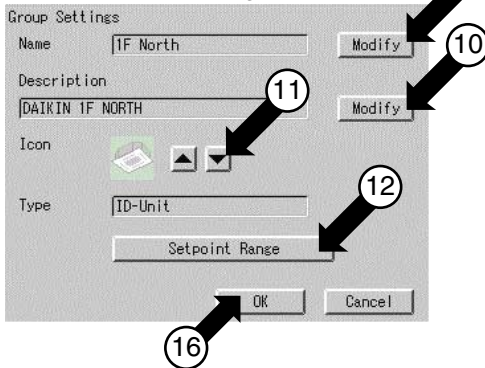

Screen 3 Enter Group Name

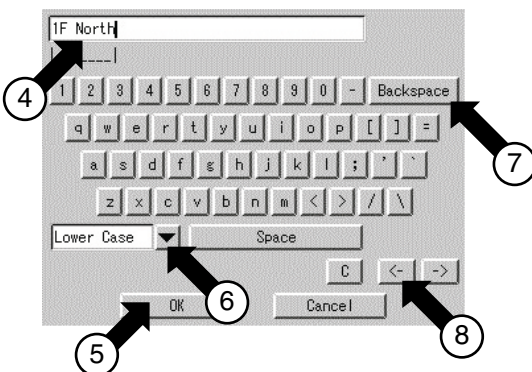

Screen 4 Setpoint Range

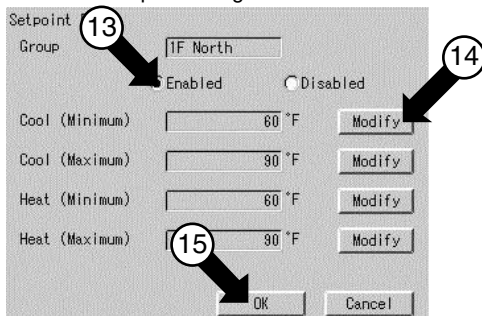

Group Settings

1. Select **Zone/Group** at Screen 2(A) on page 63.
2. Screen 1 Zone/Group, which is shown on the left, appears.
3. Select the group to be set with ①. Press the [Settings] button ②. Group Settings in Screen 2 is displayed.
4. Press the [Modify] button ③. Screen 2 Enter Group Name appears. Use the keyboard on the panel to enter the name in such a way that it is contained in the area ④. If it is not contained in the area, reduce the number of characters and reenter.

[How to use the keyboard]

 - ⑥ : Button to select between uppercase and lowercase.
 - ⑦ : Button to correct wrong entries made. Pressing one time deletes one character leftward starting at the cursor.
 - ⑧ : Button to move the cursor.

When all entries have been made, press the [OK] button ⑤. To cancel, press the [Cancel] button. Screen 2 Group Settings reappears.
5. Press the [Modify] button ⑩ and enter the name as shown in step 4 above.
6. Press the [▲] or [▼] button ⑪ to select an icon. The selection of icon does not affect the operation of the group.
7. Press the [Setpoint Range] button ⑫. Screen 4 Setpoint Range appears. Select **Enabled** or **Disabled** ⑬ for Limits Setup for the group currently selected. If you select Yes, set the limits by press the [OK] button ⑮. Press the [Modify] button ⑭ and set the restriction range. Screen 2 Group Settings reappears.
8. Select the position with the [Down] or [Up] button ⑰ for showing the group currently selected within the zone.
9. Press the [OK] button ⑱. To cancel the setting, press the [Cancel] button.

System Settings Menu Operation

Screen 1 Zone/Group

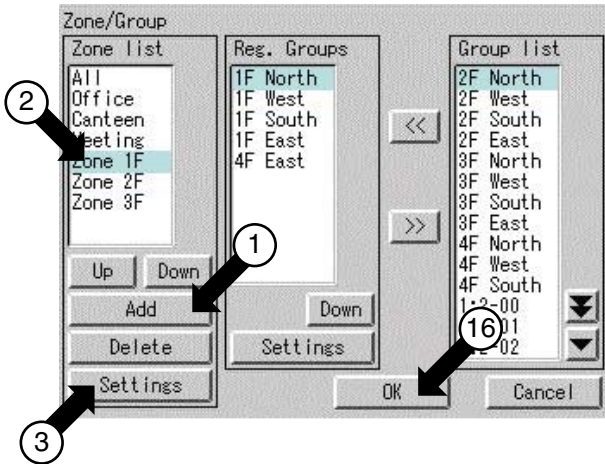

Screen 2 Zone Settings

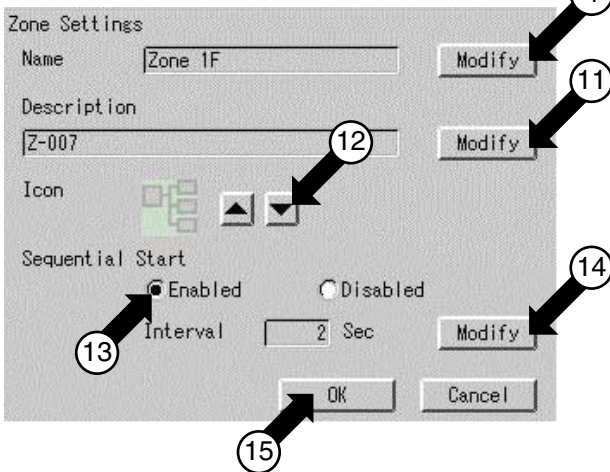

Screen 3 Enter Group Name

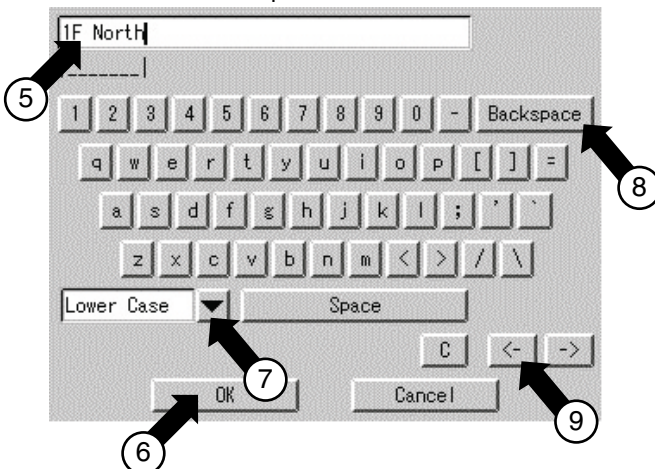

Zone Settings

1. Select **Zone Settings** at Screen 2(A) on page 63.
2. Screen 1 Zone/Group, which is shown on the left, appears.
3. To add a zone, press the [Add] button ①. A zone is added with the name Z-000. To modify the zone, select with ② the zone to be modified. Press the [Setup] button. Zone Settings in screen2 is displayed.
4. Press the [Modify] button ④. Screen 3 Enter Group Name appears. Use the keyboard on the panel to enter the name in such a way that it is contained in the area ⑤. If it is not contained in the area, reduce the number of characters and reenter.

[How to use the keyboard]

 - ⑦ : Button to select between uppercase and lowercase.
 - ⑧ : Button to correct wrong entries made. Pressing one time deletes one character leftward starting at the cursor.
 - ⑨ : Button to move the cursor.

When all entries have been made, press the [OK] button ⑥. To cancel, press the [Cancel] button. Screen 2 Group Settings reappears.
5. Press the [Modify] button ⑪ and enter the name as shown in step 4 above.
6. Press the [▲] or [▼] button ⑫ to select an icon. The selection of icon does not affect the operation of the group.
7. For operation by the zone, to start the groups in the zone one by one rather than at one time, select **Enabled** for Interval Start ⑬. To start the groups at one time, select **Disabled**. If you select **Enabled**, press the [Modify] button ⑭ and set the interval time for group sequential start.

Note: For the zone Collective, the factory setting is **Enabled** for Interval Start and 2 (seconds) for Interval.

System Settings Menu Operation

Screen 3 Registered Groups Edit

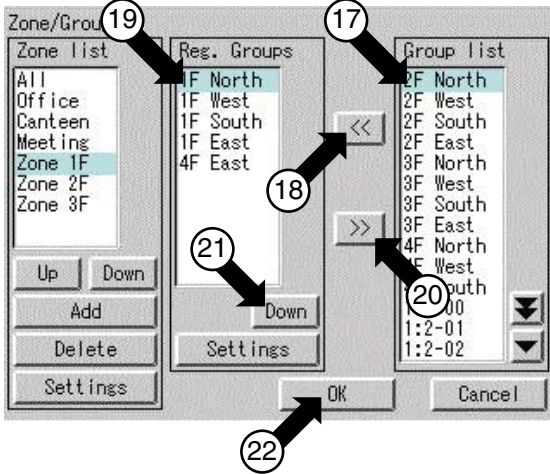

Zone Settings 2

8. Set the groups to be registered for the zone currently selected.
To add a group to the zone, select the group to be added with 17 and press the [<<] button 18.
To delete a group registered for a zone, select the group to be deleted with 19 and press the [>>] button 20.
The [Up] or [Down] button 21 allows changing the order in display of groups in the zone currently selected on the Monitoring screen.
The group shown on the top is the representative unit for the zone.
In the example of Screen 3 shown on the left, 1F Lobby is the representative unit for the zone 1F.
When all editing has been completed, press the [OK] button 22.
To cancel the setting, press the [Cancel] button.

Screen 1 Locale

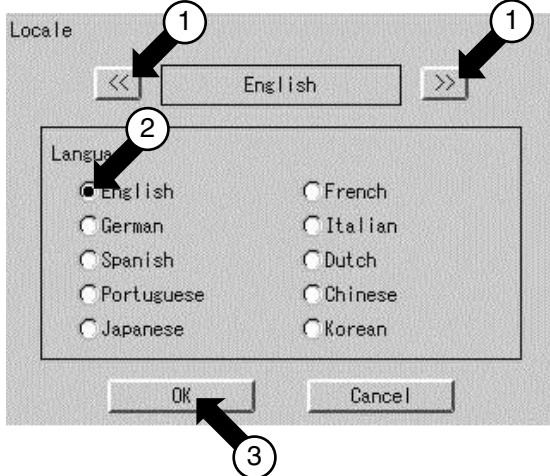

Locale

1. Select **Locale** at Screen 2(A) on page 63.
2. Confirm that the Locale screen Screen 1 will be displayed in the left-hand column.
3. Select a language by pushing [<<], [>>] button 1 on the Locale screen.
(The details of settings remain unchanged.)
4. Select a language via the Language radio button 2.
5. Last, push [OK] button 3.
To cancel the settings made, push [Cancel] button.

System Settings Menu Operation

Screen 1 Network

Network

Host name	daikin	Modify
IP address	192.168. 0. 1	Modify
Subnet mask	255.255.255. 0	Modify
Default gateway	0. 0. 0. 0	Modify
Preferred DNS	0. 0. 0. 0	Modify
Alternate DNS	0. 0. 0. 0	Modify
OK		Cancel

Numbered callouts: 1 (Host name Modify), 2 (IP address Modify), 3 (Subnet mask Modify), 4 (Default gateway Modify), 5 (Preferred DNS Modify), 6 (Alternate DNS Modify), 7 (OK button).

Network

1. Select **Network** at Screen 2(A) on page 63.
2. Confirm that the Network screen Screen 1 will be displayed as shown in the left-hand column.
3. Push the [Modify] button ① and enter a **Host name** on the resulting input screen.
4. Push the [Modify] button ② and enter an **IP address** on the resulting input screen.
5. Push the [Modify] button ③ and enter a **Subnet mask** on the resulting input screen.
6. Push the [Modify] button ④ and enter a **Default gateway** on the resulting input screen.
7. Push the [Modify] button ⑤ and enter a **Preferred DNS** on the resulting input screen.
8. Push the [Modify] button ⑥ and enter a **Alternate DNS** on the resulting input screen.
9. After making the settings, push the [OK] button ⑦.
To cancel the settings made, push the [Cancel] button.

System Settings Menu Operation

Screen 1 Web Server

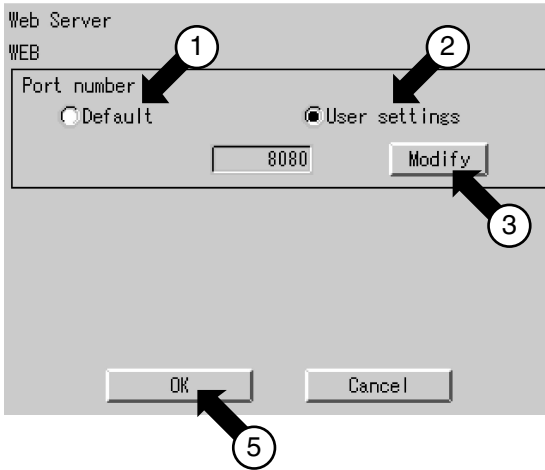

Screen 2 Input dialog

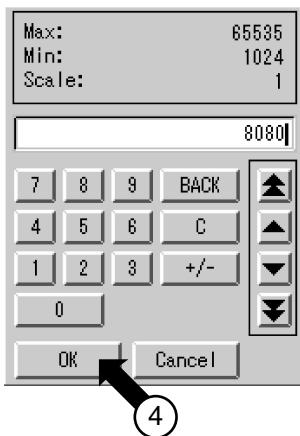

Screen 3 Confirmation

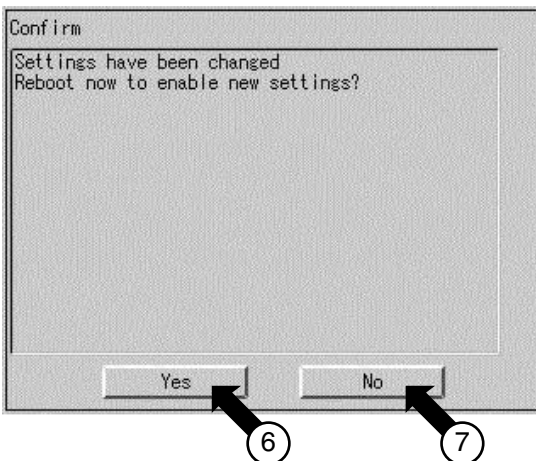

Web Server Setting

1. Select **Web Server** at Screen 2(A) on page 63.
2. Screen 1 Web Server as shown on the left will be displayed.
3. Set the desired port number. Select either **Default** (1), or **User settings** (2).
When selecting **Default** (1), continue from 5. below. The default value is 80. When **Default** is selected the [Modify] button (3) will not be displayed.
4. After selecting **User settings** (2), click the [Modify] button (3).
Screen 2 Input dialog as shown on the left will be displayed. Enter the desired value.
The user settings default value is 8080. The input range is 1024-65535.
5. After the desired value has been entered, click the [OK] button (4).
Screen 1 Web Server will be displayed.
6. Push the [OK] button (5). Screen 3 Confirmation as shown on the left will be displayed.
7. If you wish to enable the setting push the [Yes] button (6). Rebooting will commence and the setting will be completed.
If you do not wish to enable the setting, push the [No] button (7). Screen 1 Web Server will be displayed.

System Settings Menu Operation

Screen 1 Icon color

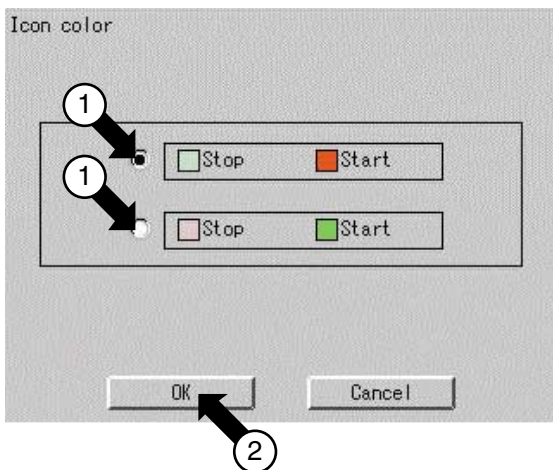

Icon Color Setting

1. Select **Icon color** at Screen 2(A) on page 63.
2. Confirm that the Icon color screen Screen 1 will be displayed as shown in the left-hand column.
3. Select a desired color via the radio button ① to change the start/stop icon color on the Icon color screen. Note that the stop icon color is light green and the start icon color red at factory setting, and the start icon color red at factory setting.
4. Push the [OK] button ②.
To cancel the settings made, push the [Cancel] button.

System Settings Menu Operation

Screen 1 Activation key input

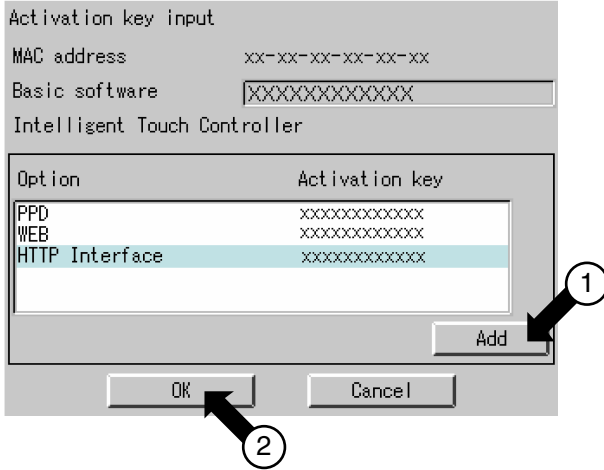

Screen 2 Input Screen

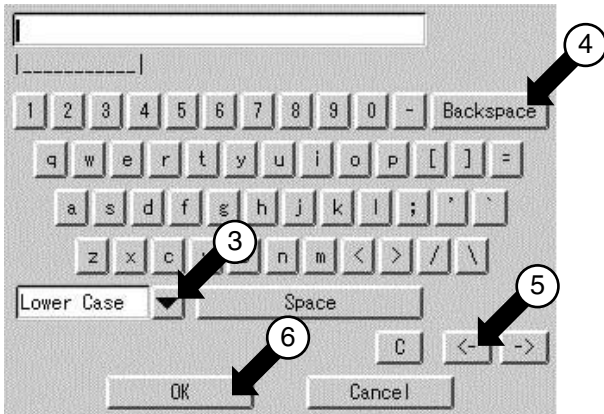

Activation Key Input

1. Scroll the System Settings menu and select **Activation key input** at Screen 2(A) on page 63.
2. Confirm that the Activation key input screen Screen 1 will be displayed as shown in the left-hand column.
3. Push the [Add] button ① and input an option software activation key on the resulting keyboard dialog. In this case, care should be taken for key input because the activation key cannot be registered so long as it contains incorrect uppercase or lowercase letters.

[How to use the keyboard]

- ③ : Button for switch uppercase to lowercase and vice versa.
- ④ : Button for deleting a character input by pressing the incorrect character key You can delete any number of characters from the cursor position to the left by pushing this button as many times as necessary.
- ⑤ : Button for moving the cursor
After making the necessary settings, push the [OK] button ⑥.
To cancel the settings made, push the [Cancel] button and return to the Activation key input screen Screen 1.

4. After adding the option, push the [OK] button ② to determine the input activation key. Then, push the [OK] button on the restart confirmation screen to restart the intelligent Touch Controller.

System Settings Menu Operation

Screen 1 Schedule

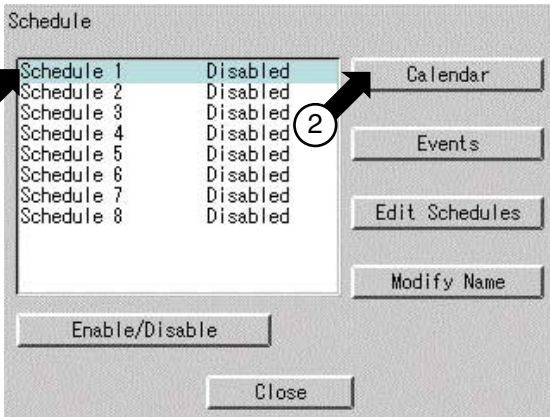

Screen 2 Calendar

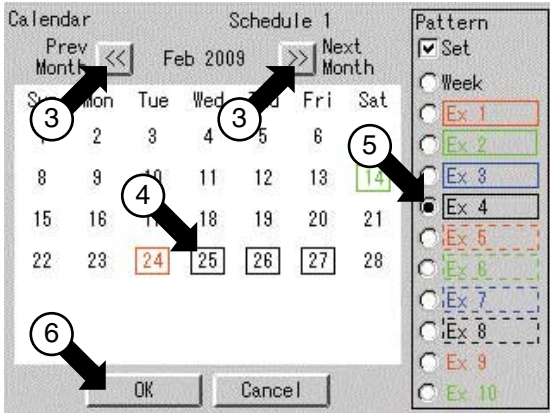

Set Schedule and Calendar

Before setting a calendar, refer to Page 35 to consider what kind of schedule to set, and to perform the operations. The following is an example for Zone 2, on Page 35.

This example shows the setting that determines which days in the year schedule to use for special days (such as the summer holidays) requiring air conditioner control different from that in the regular weekly schedule.

1. Select **Schedule** at Screen 2(B) on page 63.
2. Confirm that the Schedule screen Screen 1 will be displayed as shown in the left-hand column.
3. Select a schedule from ① to set or change the calendar.
4. Push the [Calendar] button ② to display the calendar screen Screen 2. Initially, the weekly settings are made. Select a month for change at ③ and a day for change at ④. Then, select a pattern for the selected day from ⑤.
* Check a Set checkbox to display a radio button for each pattern. This setting can be made for the coming 13 months.
5. After making the necessary settings, push the [OK] button ⑥ and return to the Schedule screen Screen 1.

System Settings Menu Operation

Screen 1 Schedule

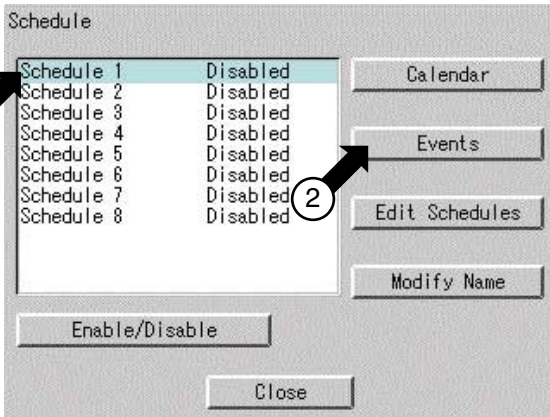

Screen 2 Event List

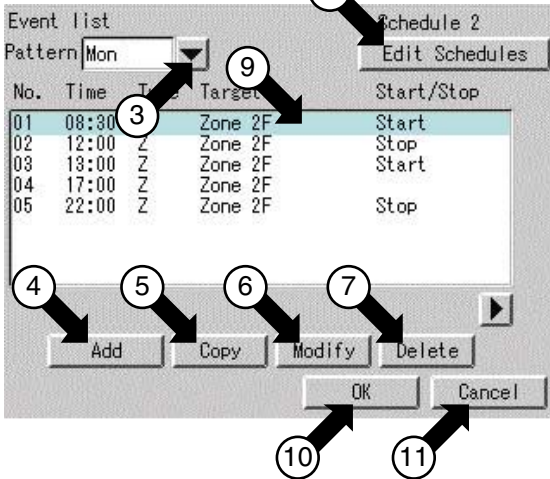

Set Schedule and Event

Before setting a event, refer to Page 36 to consider what kind of schedule to set, and to perform the operations. The following is an example for Page 36.

1. Select **Schedule** at Screen 2(B) on page 63.
2. Confirm that the Schedule Screen 1 will be displayed as shown in the left-hand column.
3. Select a schedule from ① to set or change the event(s).
4. Push the [Events] button ② to display an event list (Screen 2).
Here, actual schedule operations are set for each of 17 kinds of days (Sunday to Saturday, Ex1 to Ex10). First, use the pull-down menu ③ to determine a day of the 17 kinds of days for which events are to be set. Screen 2 indicates that Mon has been selected.
5. The following describes in order the functions of buttons ④ to ⑧.
 - ④ Add :
Use this button to add the new event. Pushing this button causes the Events Screen 3 on the next page to be displayed. For details on event setup operation, refer to the descriptions given on the next page.
 - ⑤ Copy :
Use this button to make the same setting as for the previously set event. Select the previously set event from ⑨. Push the copy button ⑤ to copy the event. Push the [Modify] button ⑥ (described below) to modify the copy event.
 - ⑥ Modify :
Use this button to change the previously registered event. Select the event to be changed from ⑨ and push the [Modify] button ⑥.
 - ⑦ Delete :
Use this button to delete the previously registered event. Select the event to be deleted from ⑨ and push the [Delete] button ⑦.
 - ⑧ Edit Schedules :
This button provides the functions similar to those of the above copy button. This button can be used to copy the events set for a set of days (Sunday to Saturday and Ex1 to Ex10) to another set of days (Sunday to Saturday and Ex1 to Ex10). (For details on Edit Schedules, refer to page 79 "Convenient Functions.")

System Settings Menu Operation

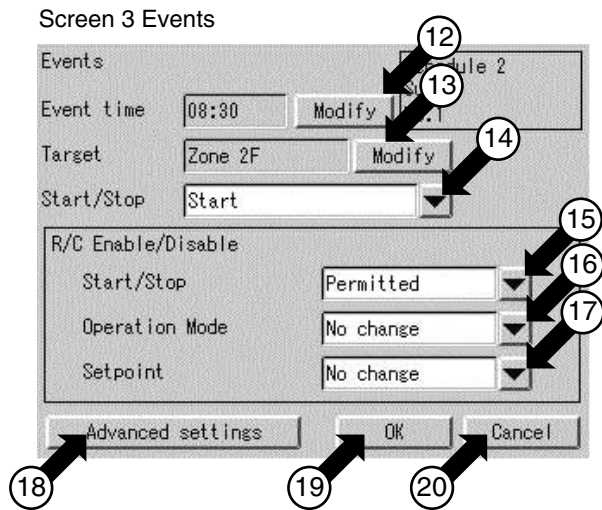

A full description of each button has been given above.

The following discusses how to make the actual settings.

To define the new operation, push the [Add] button (4). To change the previously set operation, push the [Modify] button (6).

6. Push the Add button or Modify button on the previous page, and the Event setup screen Screen 3 will be displayed. The current settings of events are shown at the left side of the buttons (12) to (17). The following describes in order the settings of events that can be made.

- Event time :
Refers to the event setting time. Display a keyboard for registering the time by pushing the [Modify] button (12) and enter the time.
- Target :
Refers to the zone or group of the air conditioner to be controlled. Push the [Modify] button (13) to select a zone or group for which schedule operations should be performed.
- Start / Stop :
Sets Start, Stop or No change. Use the pull-down menu (14) for this selection.

[How to make the setting for the remote] control at hand

Start / Stop :

Select **Permitted**, **Stop Only**, **Prohibited** or **No change** from the pull-down menu (15)

Operation Mode :

Select **Permitted**, **Prohibited** or **No change** from the pull-down menu (16).

Setpoint :

Select **Permitted**, **Prohibited** or **No change** from the pull-down menu (17).

- Advanced settings :

Push the button (18) to display an advanced settings screen Screen 4. The descriptions of the advanced settings are shown on the next page.

After setting the operation and making the advanced settings on the next page, push the [OK] button (19). To cancel the settings made, push the [Cancel] button (20) to return to Screen 2 on the previous page. When making additional settings, repeat the operations shown in steps 5 and 6. After making the necessary settings, push the [OK] button on Screen 2 of the previous page.

System Settings Menu Operation

Screen 4 Advanced settings

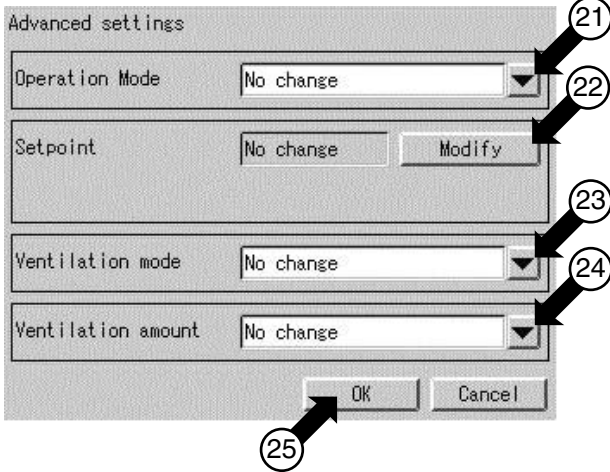

7. Push the [Advanced settings] button 18 on the Event Screen 3 to display an Advanced settings Screen 4. The current settings of events are shown at the left side of the buttons 21 to 24.

- **Operation Mode :**
Refers to the operation mode for a zone or group. Select **Cool, Heat, Auto, Fan, Dependent, Dry** or **No change**. Note that only three modes (**Dependent, Fan** and **No change**) are available when a target zone or group (being subject to mode selection) without change over option. In this case, you may select one of the modes from the pull-down menu 21.

Though the operation mode is set to Dry, some indoor unit with no change over option will not be changed to the Dry mode except in the cooling mode. Dependent :

Refers to cooling or heating. When **cooling** or **heating** has been set in an air conditioner with change over option, the air conditioner works according the selected cooling or heating operation mode.

- **Setpoint :**
Set the temperature of a zone or group. Push the [Modify] or [Disabled] button 22 according to purpose. When displaying a keyboard to register a temperature and entering a desired temperature on that keyboard, push the [Modify] button. The [Disabled] button is displayed only when the [Modify] button is pushed once and the desired temperature is set. Push the [Disabled] button to cancel the temperature set through the [Modify] button.

When ventilation is to be scheduled, the following settings can be made. Though this setting menu is displayed regardless of ventilation, no ventilation control takes place even if the setting is made.

- **Ventilation mode :**
Set the ventilation mode. You can select **Automatic, Heat Exchange, Bypass** or **No change** from the pull-down menu 23.

- **Ventilation amount :**
Set the volume of ventilation. You can select **Auto (Normal), Low (Normal), High (Normal), Auto (Freshen up), Low (Freshen up), High (Freshen up)** or **No change** from the pull-down menu 24.

After making the advanced settings, push the [OK] button 25 to return to Screen 3 on the previous page.

System Settings Menu Operation

Screen 1 Schedule

Schedule	Status
Zone 2F	Disabled
Schedule 2	Disabled
Schedule 3	Disabled
Schedule 4	Disabled
Schedule 5	Disabled
Schedule 6	Disabled
Schedule 7	Disabled
Schedule 8	Disabled

Buttons: Calendar, Events, Edit Schedules, Modify Name, Enable/Disable, Close

Change Schedule Name

1. Select **Schedule** at Screen 2(B) on page 63.
2. Confirm that the Schedule setup screen Screen 1 will be displayed as shown in the left-hand column.
3. Select a schedule from the list ① to change the name.
4. Display a keyboard screen by pushing the [Modify Name] button ② and enter a desired schedule name on that keyboard. A schedule name can be entered in up to 16 characters.

Screen 2 Event List

No.	Time	Type	Target	Start/Stop
01	08:30	Z	Zone 2F	Start
02	12:00	Z	Zone 2F	Stop
03	13:00	Z	Zone 2F	Start
04	17:00	Z	Zone 2F	Start
05	22:00	Z	Zone 2F	Stop

Buttons: Add, Copy, Modify, Delete, OK, Cancel

Change Special Day Name

1. Select a specify day from the pull-down menu ① on the event list screen to change the name.
2. Confirm that the [Modify Name] button ② will be displayed for the selected special day.
3. Display a keyboard screen by pushing the [Modify Name] button ② and enter a desired special day name. A special day name can be entered in up to 8 characters.

Screen 3 Schedule

Schedule	Status
Zone 2F	Disabled
Schedule 2	Disabled
Schedule 3	Disabled
Schedule 4	Disabled
Schedule 5	Disabled
Schedule 6	Disabled
Schedule 7	Disabled
Schedule 8	Disabled

Buttons: Calendar, Events, Edit Schedules, Modify Name, Enable/Disable, Close

Enable or Disable Schedule

1. Last, enable or disable a schedule. Perform the following operations on the schedule Screen 3. Select a schedule from the list ① and enable or disable the schedule at ②. On the confirmation screen, push the [Yes] button to enable the schedule and the [No] button to disable it. Then, check to see the display **Enabled** or **Disabled** in right side of ① to confirm that the schedule has been enabled or disabled successfully.

Even if the calendar or event is set, no schedule function works unless the schedule is enabled.

System Settings Menu Operation

Screen 1 Schedule

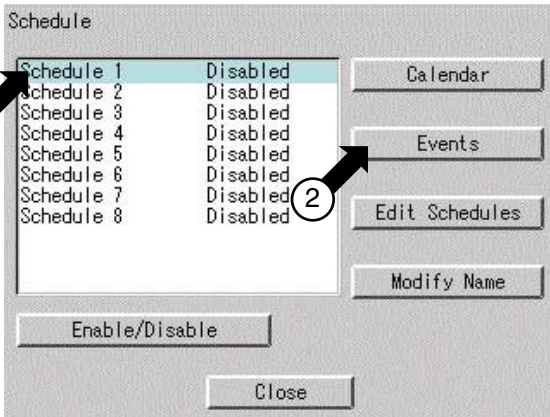

Screen 2 Event List

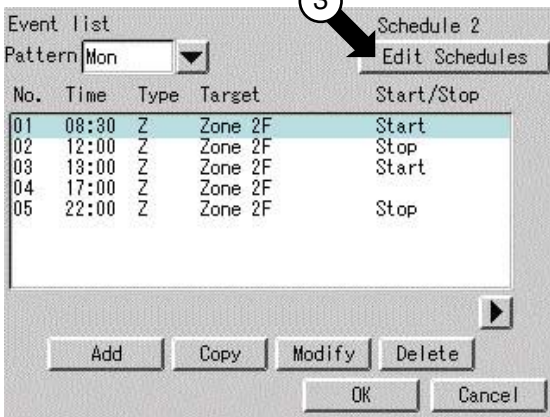

Screen 3 Copy Events

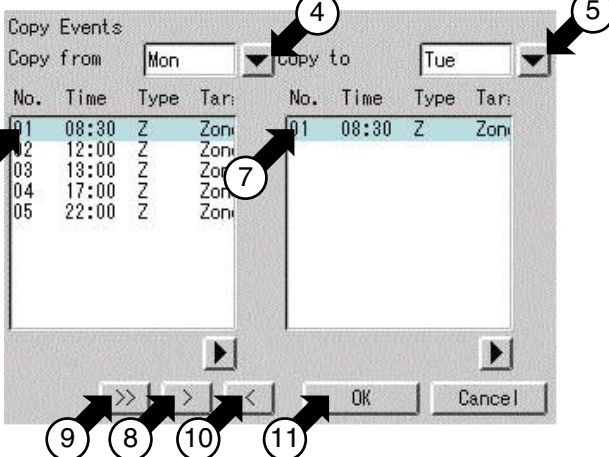

Convenient Function 1 Copy in Units of Events

* When it is necessary to reuse an event set for a day of the week, this function greatly helps you copy the event to the other day of the week.

EXAMPLE: When using the same schedule for Monday to Friday, set an event for Monday, then copy it for Tuesday to Friday to eliminate the efforts required for making the setting for each day of the week.

1. Select **Schedule** at Screen 2(B) on page 63.
2. Confirm that the Schedule Screen 1 will be displayed as shown in the left-hand column.
3. Select a schedule from ① to copy the event.
4. Push the [Events] button ② to display the Event list screen Screen 2.
5. Push the [Edit Schedules] button ③ to display the Copy Events screen Screen 3.

The following describes in order the functions of buttons ④ to ⑩.

Select a day of the week for a copy source at ④ and that for a copy destination at ⑤. In an example of the left-hand column, **Mon** is selected as a day of the week for the copy source and **Tues** as that for the day of the copy destination.

Then, select the event to be copied at ⑥ and push the [>] button ⑧ to copy the event No. 01 from Monday to Thursday.

Push the [>>] button ⑨ to copy all the events from Monday to Thursday, Push the [<] button ⑩ once to delete the event copied incorrectly from ⑦. You must push the [<] button ⑩ as many times as necessary to delete multiple incorrect settings. After making the necessary settings, push the [OK] button ⑪ to return to the event list screen Screen 2.

System Settings Menu Operation

Screen 1 Schedule

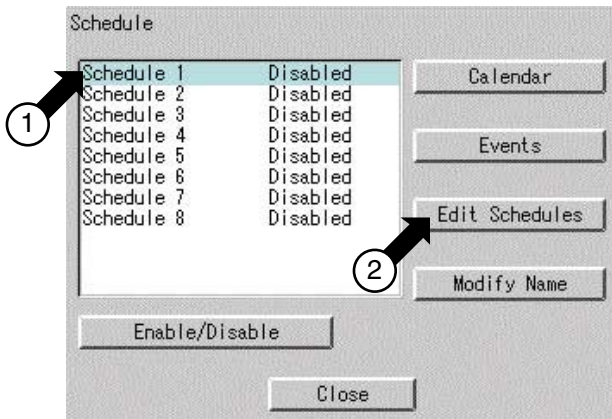

Screen 2 Edit Schedule

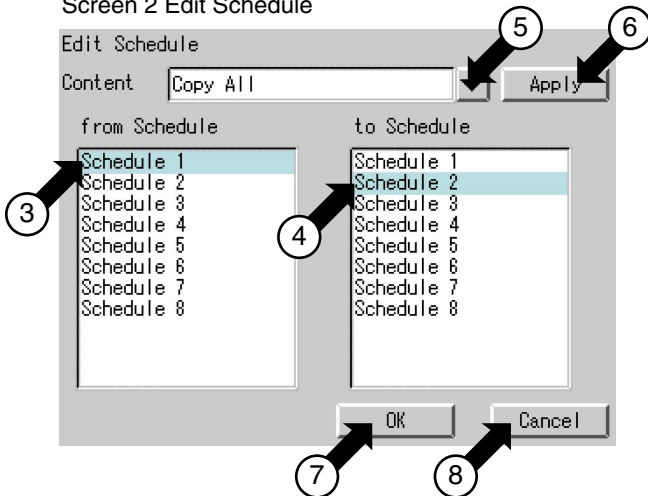

Convenient Function 2

Copy or Delete in Units of Schedules

* When it is necessary to resume a calendar setting made for schedule 1, this function greatly helps you copy the calendar setting to the other schedule(s).

EXAMPLE :

When reusing the same calendar setting (such as the summer holiday) for the other schedule, make the calendar setting for schedule 1, then copy it for the other schedule to eliminate the efforts required for making the same setting for each of the other schedules.

1. Select **Schedule** at Screen 2(B) on page 63.
2. Confirm that the Schedule screen Screen 1 will be displayed as shown in the left-hand column.
3. Push the [Edit Schedules] button ② to display the Edit Schedule screen Screen 2.

(For setup item copy)

Select a schedule for a copy source at ③ and that for a copy destination at ④. In an example of the left-hand column, the schedule of the copy source is schedule 1 and that of the copy destination schedule 2. Next, select the setup item (to be copied) of schedule 1 from the pull-down menu ⑤. The following setup items can be selected.

- Copy All
- Copy Calendar

After selecting either of the above items, push the [Apply] button ⑥. Last, push the [OK] button ⑦ to terminate the copy procedure. To cancel the settings made, push the [Cancel] button ⑧ and return to the schedule screen Screen 1.

(For setup item deletion)

Select the schedule to be deleted at ④. Next, select the setup item to be deleted from the pull-down menu ⑤. The following setup items can be selected.

- Delete All
- Delete Calendar

After selecting either of the above setup items, push the [Apply] button ⑥. Last, push the [OK] button ⑦. To cancel the settings made, push the [Cancel] button ⑧ and return to the schedule screen Screen 1.

System Settings Menu Operation

Screen 1 Automatic Changeover

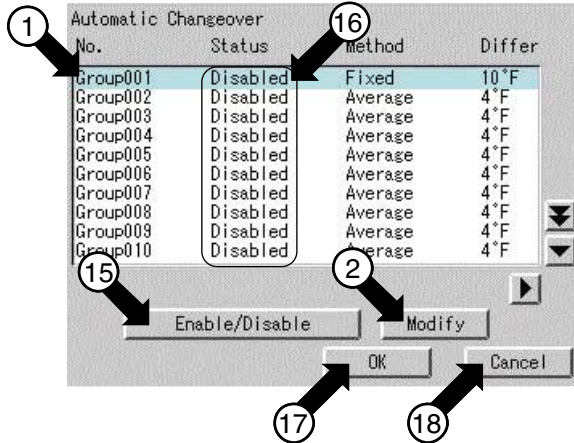

Screen 2 Cooling/Heating Automatic Change Over Group Settings

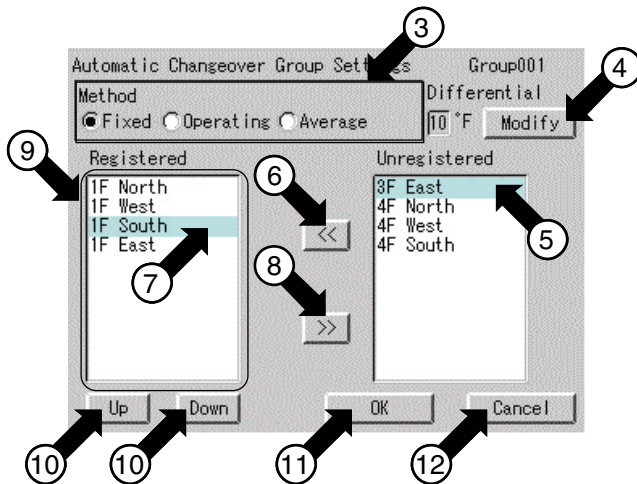

Screen 3 Confirmation

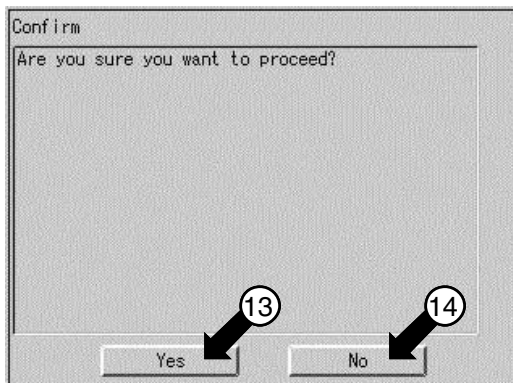

Operation of Automatic Changeover

Before performing Automatic Changeover, thoroughly read the Automatic Changeover section on page 37, and perform the following procedures:

- See page 63 and select **Automatic Changeover**.
- Screen 1 Automatic Changeover, which is shown on the left, appears.
This screen shows current status (enabled / disabled) of each cooling / heating automatic change over group, control method, set value of temperature difference, and the number of the registered indoor unit groups.
- Touch a cooling / heating automatic change over group to be set or changed as shown by ①, and press the [Modify] button ②.
- Screen 2 Cooling / Heating Automatic Changeover Group Settings, which is shown on the left, appears. First, select a control method at ③. The following three control methods are available.
 - Fixed • Operating • Average
 For details of each control method, see page 37.
- Set a temperature difference value for cooling / heating automatic change over with the [modify] button ④.
Setting range: 2°F - 13°F
- At ⑤, select an indoor unit to be added to the cooling / heating automatic change over group which is currently selected, and press the button ⑥ to add.
To delete an indoor unit from the cooling / heating automatic change over group, select it at ⑦, and press the button ⑧.
- To change the order of the registered indoor group ⑨, select an indoor unit to be changed at ⑦, and move it with the [Up] button or the [Down] button ⑩.
Memo: When the control method **Fixed** is selected, the indoor unit displayed on the top in the box ⑨ becomes the representative one. When the operation method **Operating** is selected, a search for representative unit is performed starting from the top.
- When all settings for this cooling / heating automatic change over group (control method, temperature difference, indoor unit registration) are completed, press the [OK] button ⑪ (To cancel, press the [Cancel] button ⑫.)
Screen 3 Confirmation Display appears. When there is no problem in setting change, press the [Yes] button ⑬.
Screen 1, which is shown on the top on this page, appears. (To add or change the settings in the cooling / heating automatic change over group mentioned above, press the [No] button ⑭. Screen 2 appears.)
- On the screen 1, select the cooling / heating automatic change over group to be enabled at ①, and press the button ⑮ to enable. (Confirm the group status (enabled / disabled) displayed on ⑯.) Only the cooling / heating automatic change over group set to enabled is controlled automatically.
- Lastly, when all the setting changes are correct, press the [OK] button ⑰. (To cancel, press the [Cancel] button ⑱.) When the [OK] button ⑰ is pressed, the screen 3 Confirmation Display appears. When there is no problem in setting change, press the [Yes] button ⑲. This menu is ended, and System Settings Menu appears. (When the [No] button ⑳ is pressed, the screen 1 appears.)

System Settings Menu Operation

Screen 1 Temperature Limit

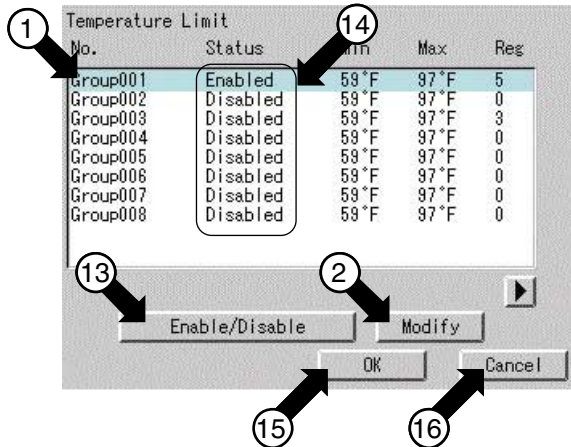

Screen 2 Room Temperature Upper/Lower Limit Control Group Settings

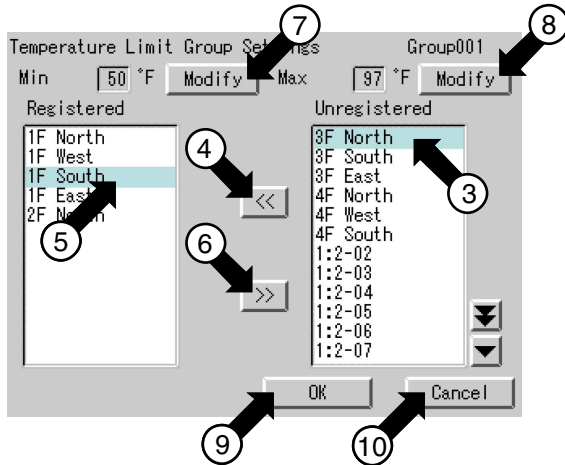

Screen 3 Confirmation

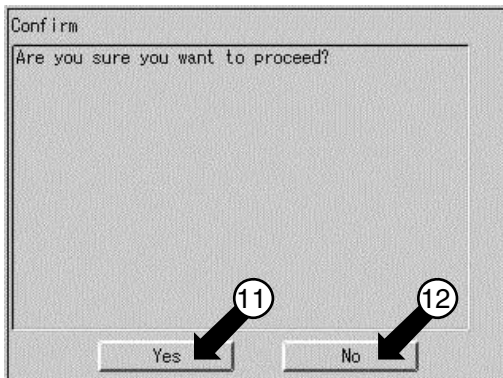

Operation of Temperature Limit

Before performing Temperature Limit, read thoroughly the section Temperature Limit on page 42, and perform the following procedure.

1. See page 63 and select **Temperature Limit**
2. Screen 1 Temperature Limit, which is shown on the left, appears.
This screen shows current status (enabled / disabled) of room temperature upper / lower limit control group, and setting status of lower temperature limit, upper temperature limit, and the number of registered indoor unit groups.
3. Touch a room temperature upper / lower limit control group to be set or changed as shown by ①, and press the [Modify] button ②.
4. Screen 2 Room Temperature Upper / Lower Limit Control Group Settings, which is shown on the left, appears. First, at ③, select the indoor unit to be added to the room temperature upper / lower limit control group which is currently selected, and press the button ④ to add. To delete an indoor unit from the group, select it at ⑤, and press the button ⑥.
5. Set a lower limit of room temperature with the [Modify] button ⑦, and an upper limit of room temperature with the [Modify] button ⑧. Setting range : 36°F - 60°F for lower limit, 90°F - 122°F for upper limit
6. When all settings for this room temperature upper / lower limit control group (indoor unit registration, settings of upper limit and lower limit) are completed, press the [OK] button ⑨. (To cancel, press the [Cancel] button ⑩.) Screen 3 Confirmation Display appears. When there is no problem in setting change, press the [Yes] button ⑪.
Screen 1, which is shown on the top on this page, appears.
To add or change the settings in the room temperature upper / lower limit control group mentioned above, press the [No] button ⑫. Screen 2 appears.
7. On the screen 1, select a room temperature upper / lower limit control group to be enabled at ①, and press the button ⑬ to enable. Confirm the group status (enabled / disabled) displayed on ⑭.
Only the room temperature upper / lower limit control group set to enabled is controlled automatically.
8. Lastly, when all the setting changes are correct, press the [OK] button ⑮. (To cancel, press the [Cancel] button ⑯.)
When the [OK] button ⑮ is pressed, the screen 3 Confirmation Display appears. When there is no problem in setting change, press the [Yes] button ⑪. This menu is ended, and System Settings Menu appears. (When the [No] button ⑫ is pressed, the screen 1 appears.)

System Settings Menu Operation

Screen 1 Heating Mode Optimization

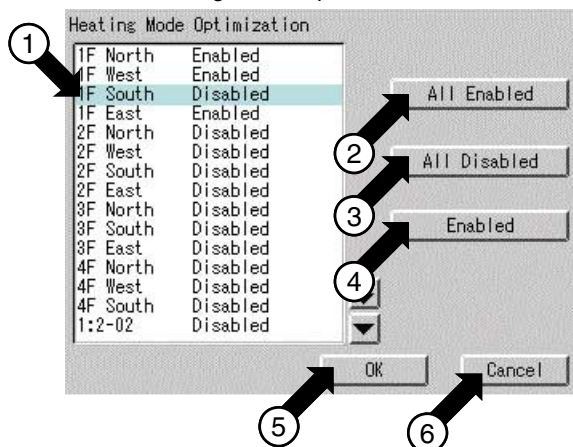

Screen 2 Confirmation

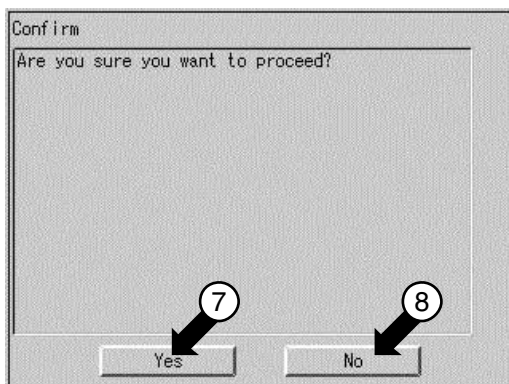

Operation of Heating Mode Optimization

Before performing Heating Mode Optimization, thoroughly read the Heating Mode Optimization Settings section on page 45, and perform the following procedures:

1. See page 63 and select Heating Mode Optimization.
2. Screen 1 Heating Mode Optimization, which is shown on the left, appears. This screen shows current registration status of Heating Mode Optimization.
3. Touch an indoor unit to be added as shown by ①, and press the button ② to add. To deactivate this control, select an indoor unit at ③, and press the button ④.
4. Lastly, when all indoor units are registered, press the [OK] button ⑤. (To cancel, press the [Cancel] button ⑥.) Screen 2 Confirmation Display appears. When there is no problem in setting change, press the [Yes] button ⑦. This menu is ended, and System Settings Menu appears. To continue the change, press the [No] button ⑧. The screen 1 appears.

System Settings Menu Operation

Before use of the FC Change Over

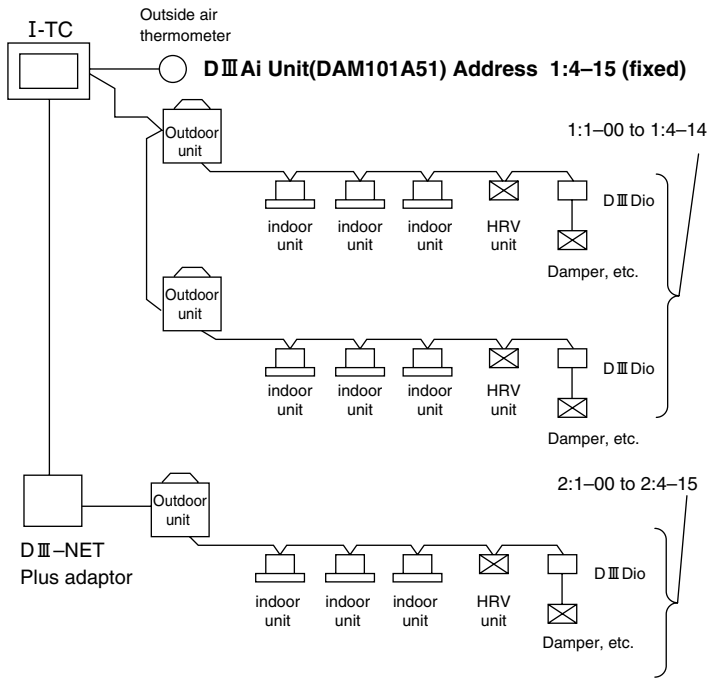

NOTE 1)
 When FC Change Over function mode is selected, the number of groups of the indoor units intelligent Touch Controller is capable of controlling/monitoring becomes to 63 from 64.
 Because the Ai Unit (DAM101A51) must be set 1:4-15 to enable the FC Change Over function. Thus the other D3 Address are 1:1-00 to 1:4-14. When D III-NET Plus adaptor is enabled :1:1-00 to 1:4-14 and 2:1-00 to 2:4-15
 DAM101A51 is corresponding to DCS601C51 for use.

Screen 1 Standard Operation Mode

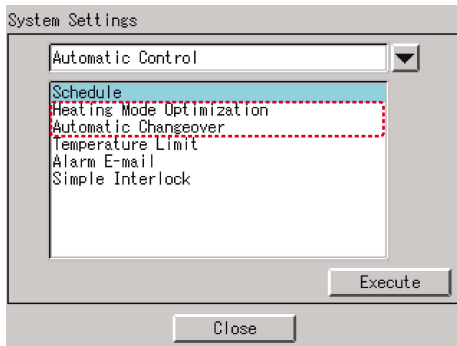

Screen 2 FC Change Over Mode

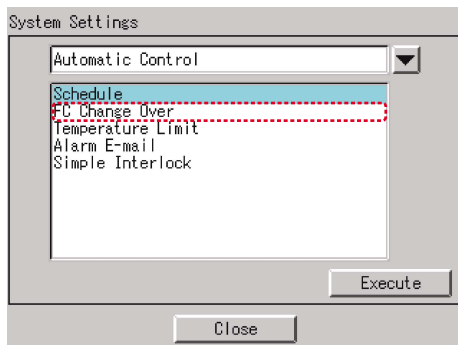

NOTE 2)
 When in FC Change Over function mode, the following function does not work, instead of FC Change Over function.

ID-Unit Group Settings
 • Setpoint Range Limitation

Automatic Control
 • Heating Mode Optimization
 • Automatic Changeover

Please confirm the service engineer that those setting are reset, when changing Function Mode from Standard Operation Mode to FC Change Over Mode

System Settings Menu Operation

Screen 1 FC Change Over

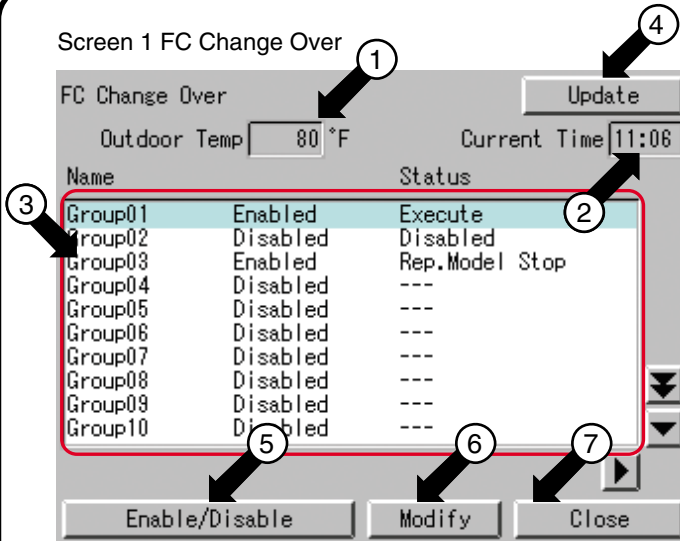

Screen 2 Confirm

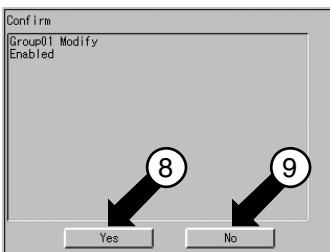

Screen 3 Confirm

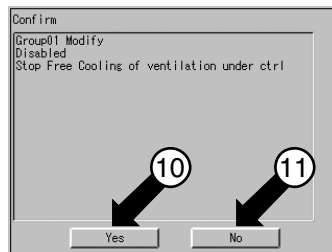

Screen 4 Confirm

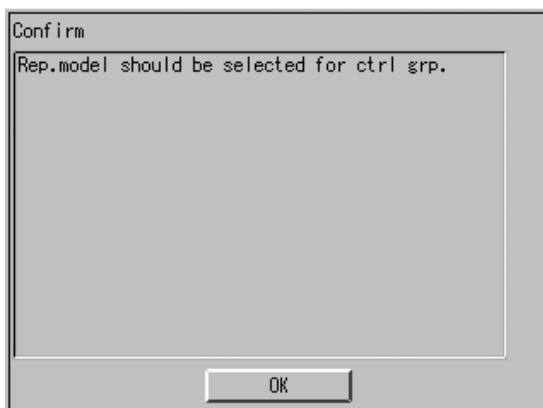

Setting of the FC Change Over

Read page 47 for the function of FC Change Over. This chapter explains how to make settings for FC Change Over.

[Restrictions]

- Use the Master ITC to make settings. (No setting is possible from the Slave ITC.)

1. Select **FC Change Over** in the menu window shown in page 63 to show screen 1.

[Description of the FC Change Over window]

- ① Outdoor Temp: Indicates the present outdoor temperature.
- ② Current time: Indicates the current time.
- ③ The control group list shows the following items:
Name: Name of control group
Status of Enable/Disable control
Status: **Rep. Model Err, Out Temp Sense Err, Rep. Model Stop, Disabled, Execute**
Free Cooling: (when executed),
 (when not executed)
Operation mode: **Cool, Heat, Fan**
Rm Temp: Suction temperature of the representative model
Cool Setup: Preset cooling temperature (Highest comfortable temperature)
Heat Setup: Preset heating temperature (Lowest comfortable temperature)

[Anomalies]

- When the representative model suffers an anomaly, the indication shown for **Free cooling Rm Temp** and **Operation mode** in ③ The control group list is "----."
- When the outside temperature sensor malfunctions, "----" is shown for **Outdoor Temp** and **Free Cooling**.

2. Press [Update] button ④ to update the description.

3. Select a control group and press [Enable/Disable] button ⑤, and screen 2(when Enable) or screen 3 (when Disable) is shown. Press [Yes] button ⑧ or ⑩ to switch between Enable and Disable. Press [No] button ⑨ or ⑪ to cancel the settings.

* When control is present to Disable, no FC Change Over will be conducted.

* When control is present to Enable, and Rep.model is not registered the screen 4 is shown.

4. When changing the settings of a control group, select any given control group and press [Modify] button ⑥ to show the Control group setting screen. When control is Enable, the screen appears in the read-only mode. (See page 86.)

5. Press [Close] button ⑦ to close the FC Change Over screen.

System Settings Menu Operation

Screen 1 Confirm

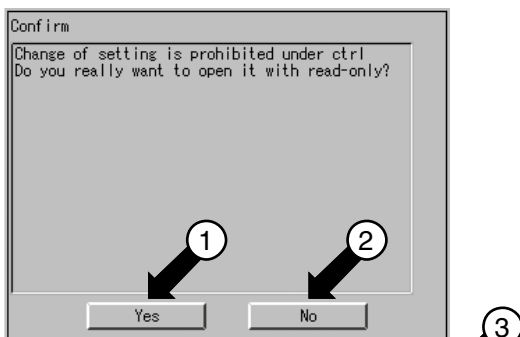

Screen 2 Control group setting

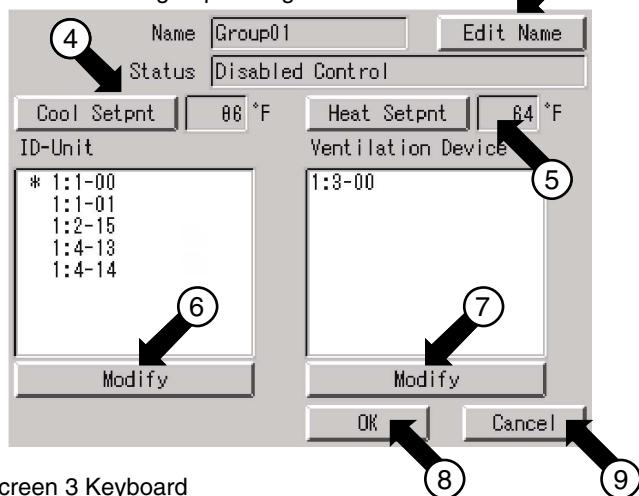

Screen 3 Keyboard

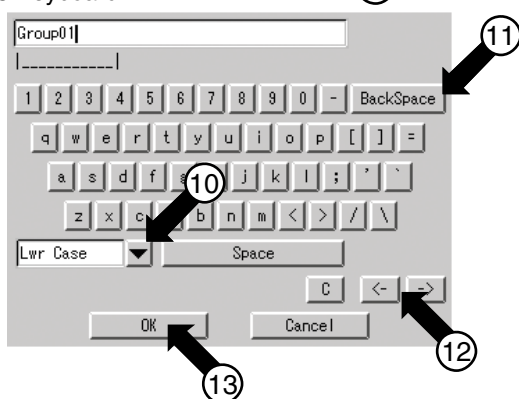

Screen 4 Confirm



Screen 5 Confirm

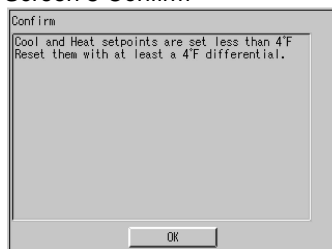

Setting of the FC Change Over

1. When the control group selected in the FC Change Over screen is Enable, Screen 1 for confirmation is shown to confirm read-only mode.
Press [Yes] button ① to show the Control group setting screen in a read-only mode.
Press [No] button ② to return to the FC Change Over screen.
2. When changing the name of a control group, press [Edit name] button ③ and change the name with the keyboard. Enter a name using up to 12 one-byte characters.

[How to use the keyboard]

- ⑩ :Button for switch uppercase to lowercase and vice versa.
- ⑪ :Button for deleting a character input by pressing the incorrect character key.
You can delete any number of character from the cursor position to the left by pushing this button as many time as necessary.
- ⑫ :Button for moving the cursor.
After making the necessary settings, push the [OK] button ⑬.
To cancel the settings made, push the [Cancel] button and return to the Control group setting screen 2.

3. Set the preset cooling temperature ④ or preset heating temperature ⑤.
The preset range of cooling temperature is between 68°F and 86°F
The preset range of heating temperature is between 64°F and 82°F
Set the preset cooling temperature by 4°F or more higher than the preset heating temperature.
4. When making settings for indoor units in a control group, press [Modify] button ⑥ to show the indoor unit registration screen (See page 87).
5. When making settings for Ventilation Device in a control group, press [Modify] button ⑦ to show the Ventilation Device registration screen (See page 88).
6. Press [OK] button ⑧ to save the settings.
Press [Cancel] button ⑨ to cancel the settings.

[Setting error]

- When the preset cooling temperature is not 36°F or more higher than the preset heating temperature, an error screen, either screen 4 or screen 5, is shown.

System Settings Menu Operation

Screen 1 Registration of Indoor Unit

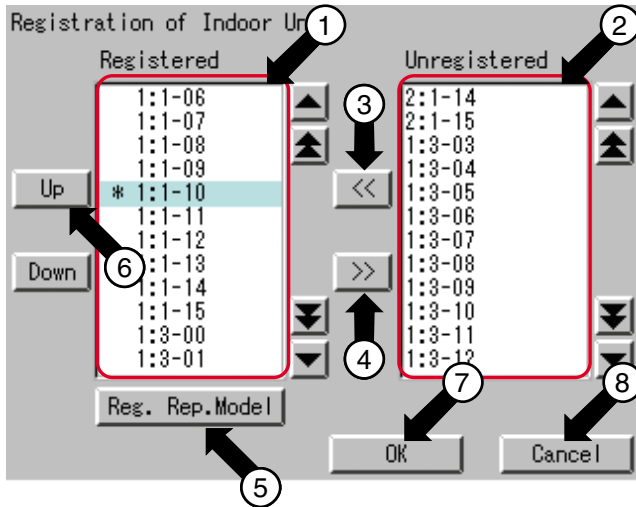

Screen 2 Confirm

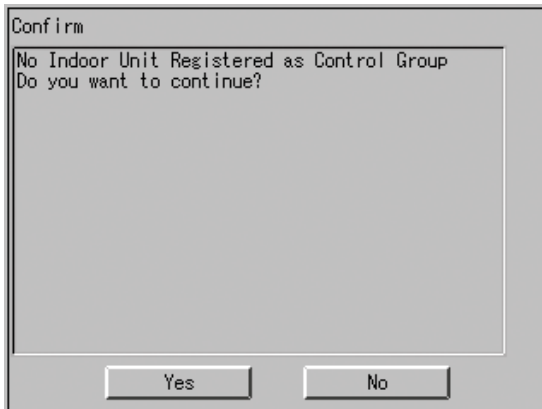

Screen 3 Confirm

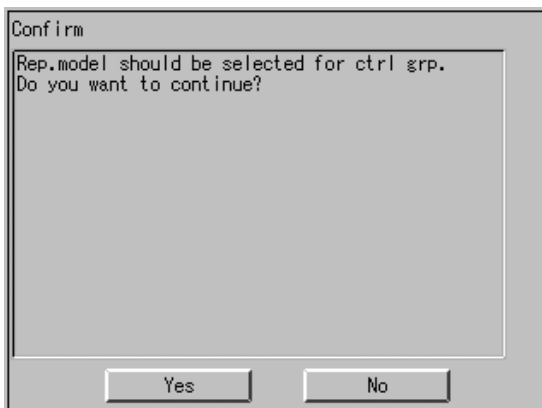

Setting of the FC Change Over

1. The **Registered** list ① shows indoor units registered in a control group.
The **Unregistered** list ② shows indoor units not shown in the **Registered** list ①.
 2. When adding an indoor unit to a control group, select a unit to add from the Unregistered list ② and press [<<] button ③. (The added unit is then relocated to the Registered list ①.)
 3. When deleting a indoor unit from a control group, select a unit to delete from the Registered list ① and press [>>] button ④. (The deleted unit is then relocated to the Unregistered list ②.)
- [Restrictions]
A single indoor unit cannot be registered in two or more control groups.
4. When registering a representative indoor unit, select a unit in the Registered list ① and press the [Reg. Rep. Model] button ⑤.
* mark is added to the top of the name of the indoor unit selected as the representative one.
 5. When changing the order of display of indoor units in the Registered list ①, select a unit and press [Up] or [Down] button ⑥.

NOTE:

- Always put the indoor unit that has the cooling-heating switchover right on the top. If not, the FC Change Over will not properly work.
- Please do not set the indoor unit where the room temperature changes often near the window etc. as a representative indoor unit for the prevention of hunting in the FC Change Over.

6. Press [OK] button ⑦ to save the settings and return to the Control group setting screen. The settings will be saved when the [OK] button in the Control group setting screen is pressed.
Press [Cancel] button ⑧ to cancel the settings.

Setting error:

- When any of the following errors occurs during setting, an error screen will appear.
- When no indoor units are registered. (screen 2)
- When no representative unit is selected in the indoor unit registration screen. (screen 3)

System Settings Menu Operation

Screen 1 Ventilation Device registration

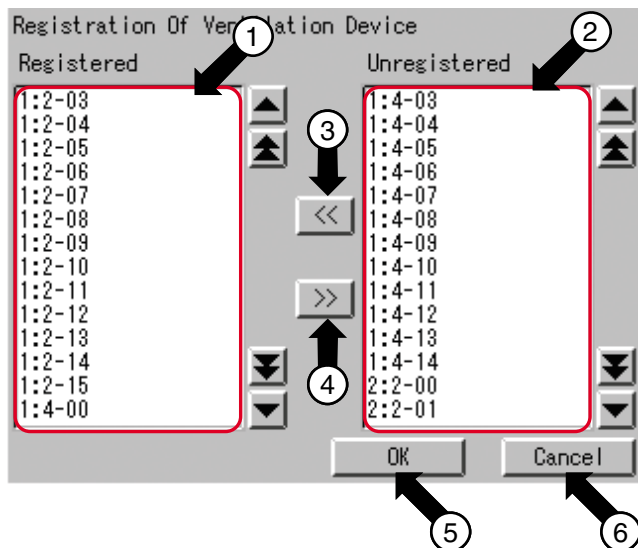

Setting of the FC Change Over

1. Ventilation Device registered in a control group are shown in the **Registered** list ①. Ventilation Device not shown in the **Registered** list ① are shown in the **Unregistered** list ②.
2. When adding a Ventilation Device to a control group, select a Ventilation Device to add from the Unregistered list ② and press [**<<**] button ④. The added Ventilation Device is then relocated to the Registered list ①.
3. When deleting a Ventilation Device from a control group, select a Ventilation Device to delete from the Registered list ① and press [**>>**] button ③. The deleted Ventilation Device is then relocated to the Unregistered list ②.

[Restrictions]

A single Ventilation Device cannot be registered in two or more control groups.

4. Press [**OK**] button ⑤ to save the settings and return to the Control group setting screen. The setting will be saved when the [**OK**] button in the Control group setting screen is pressed. Press [**Cancel**] button ⑥ to cancel the settings.

[Action when no Ventilation Device is registered]

When no Ventilation Device is registered in a control group, the Change Over alone will work, and no Free Cooling will work.

System Settings Menu Operation

Screen 1 History

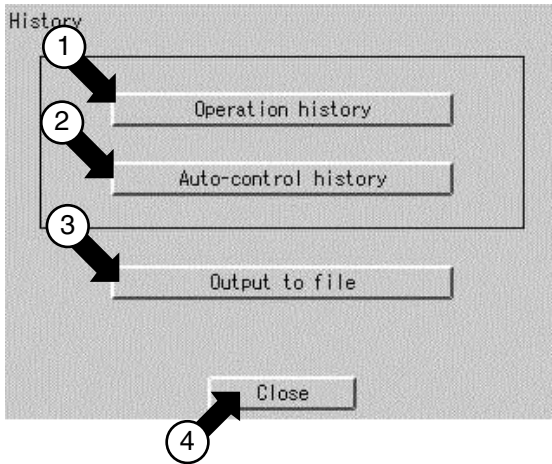

Screen 2 Operation History

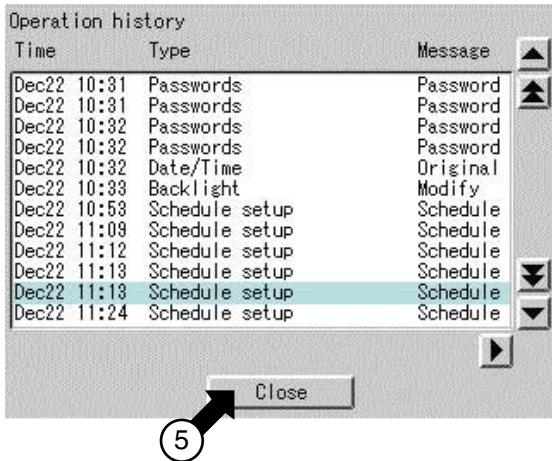

Screen 3 Auto-control history

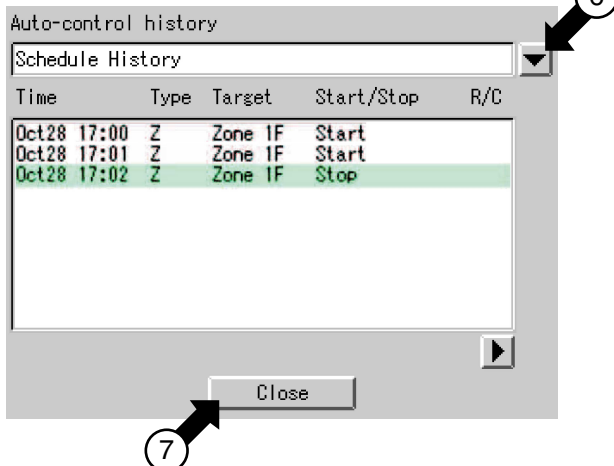

Check for History

1. **Select History** at Screen 2(A) on page 63.
2. The History screen Screen 1 appears as shown in the left-hand column.
3. When checking for the history of system Settings operations, touch the [Operation history] button ① to confirm that the Operation history screen Screen 2 is displayed. The system settings operations recorded in the controller are displayed in the order where they have been performed.
4. To return to the History screen, touch the [Close] button ⑤.
5. When checking for the history of automatic control operations, touch the [Auto-control history] button ② to confirm that the Auto-control history screen Screen 3 is displayed.
6. Use the pulldown menu ⑥ to display the following items on the related screens :
 - Schedule History
Use this item to display log records on schedule execution.
 - Heating opt. cntl. History
Use this item to display log records on optimal stop control during heating.
 - Temperature Limit. History
Use this item to display log records on upper- / lower-limit control for the room temperature.
 - Simple Interlock History
After activating optional software, additional items are displayed from the drop-down menu ⑥.
 - E-mail History
7. To return to the History screen Screen 1, touch the [Close] button ⑦.
8. When saving the stored log records in a memory card, insert a commercially available PCMCIA flash memory card into a slot provided at the left side of the controller and touch the [Output to file] button ③.
* Care should be taken for memory card insertion. Be sure to insert a memory card in such a way that the rear side of the card (not provided with a label for the manufacturer name and model name) should face upwards.
When the memory card has been forcibly inserted in wrong direction, the controller may be damaged.
Then, touch the [OK] button to save the log records in the memory card.
9. After checking the log record, touch the [Close] button ④.

System Settings Menu Operation

Screen 1 Touch Panel Calibration

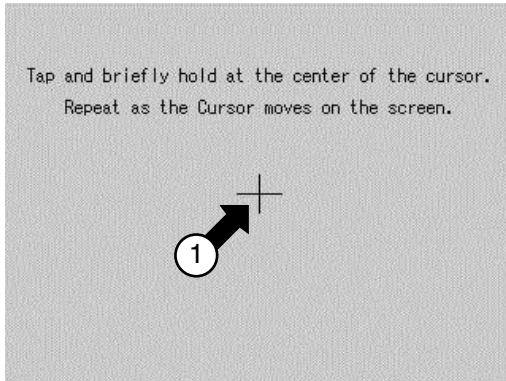

Touch Panel Calibration

1. See page 63 and select Touch Panel **Calibration**.
2. Screen 1 Touch Panel Calibration, which is shown on the left, appears.
3. Follow the instruction shown on the screen and press the intersection of the crosshairs ① and keep it pressed for about 1 second.
4. The crosshairs are moved. Repeat the operation described in step 3 on a total of five points. When calibration is finished, the System Settings automatically appears within 30 seconds.

Screen 1 Alarm E-mail

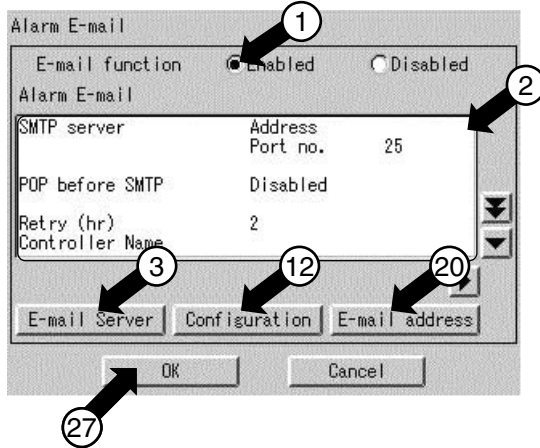

Alarm E-mail

* The e-mail function (option) comes standard with the Web function.

1. Select **Alarm E-mail** according to the operating procedure shown in page 63.
2. Confirm that the Alarm E-mail screen Screen 1 will be displayed as shown in the left-hand column.
3. Select **Enabled** or **Disabled** for the e-mail function ①. When **Disabled** has been selected, there is no additional setup operation for the e-mail function. To continue the setup operation, be sure to select the [OK] button ⑲.
4. You can monitor the current setting in the display area ②.
5. Push the [E-mail Server] button ③ to display the E-mail server Settings screen Screen 2 will be displayed as shown in the left-hand column.
6. Push the [Modify] button ④ and enter an SMTP server address on the input screen.
7. Push the [Modify] button ⑤ and enter an SMTP server port number on the input screen.
8. Select **Enabled** or **Disabled** for the POP server ⑥.
9. Push the [Modify] button ⑦ and enter a POP server address on the input screen.
10. Push the [Modify] button ⑧ and enter a POP server port number on the input screen.
11. Push the [Modify] button ⑨ and enter a POP server user ID on the input screen.
12. Push the [Modify Password] button ⑩ and enter a POP server password on the input screen.
13. Last, push the [OK] button ⑪ to return to the Alarm E-mail screen Screen 1. (To cancel the settings made, push the [Cancel] button.)
14. Push the [Configuration] button ⑫ to display the Alarm E-mail Configuration screen on the next page Screen 3.

Screen 2 E-mail server Settings

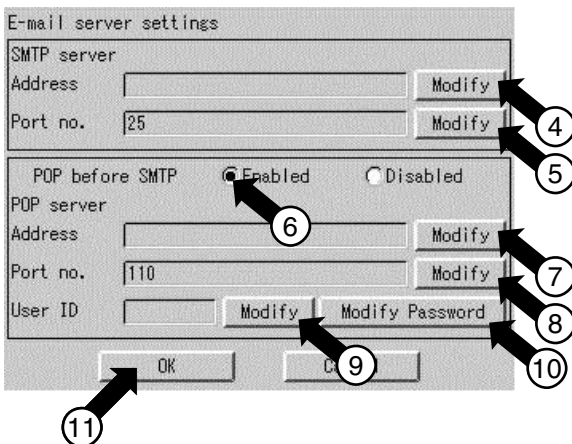

System Settings Menu Operation

Screen 3 Alarm E-mail Configuration

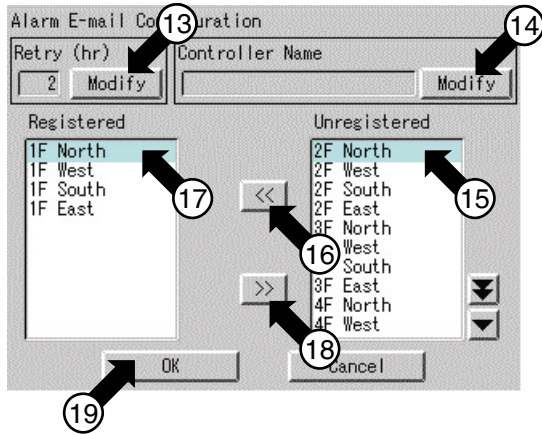

Screen 4 E-mail address Settings

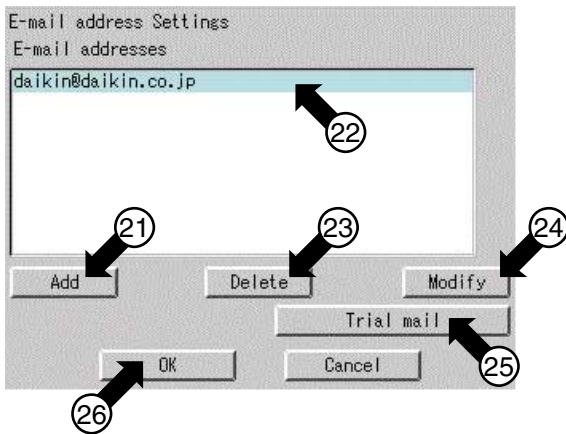

15. Push the [Modify] button ⑬ and enter a retransmission interval on the input screen. The retransmission interval is an e-mail retransmission interval when faults occur consecutively with the equipment. This interval time (hour) must be a value from 1 to 72. Initially, it is set to 2 hours.
 16. Push the [Modify] button ⑭ and enter an ITC identifier on the input screen. The name specified here is displayed in the Subject field during e-mail transmission.
 17. When adding an air conditioner for fault confirmation by e-mail, select the air conditioner at ⑮ and push the [<<] button ⑯. When deleting an air conditioner for fault confirmation by e-mail, select the air conditioner at ⑰ and push the [>>] button ⑱.
- After finishing the necessary edit operations, push the [OK] button ⑲ to return to the Alarm E-mail screen on the previous page Screen 1.
- To cancel the settings made, push the [Cancel] button.
18. Push the [E-mail address] button ⑳ on the previous page to display the E-mail address Settings screen Screen 4.
 19. When adding an e-mail address for fault notification by e-mail, push the [Add] button ㉑ and enter the e-mail address on the input screen. Note that a maximum of 3 e-mail addresses can be registered. When deleting an e-mail address, select the address at ㉒ and push the [Delete] button ㉓. In addition, when changing the registered e-mail address, select the address at ㉒ and push the [Modify] button ㉔.
 20. When sending test e-mail, select a destination e-mail address at ㉒ and push the [Trial mail] button ㉕.
 21. After making the necessary settings, push the [OK] button ㉖ to return to the Alarm E-mail screen on the previous page Screen 1. To cancel the settings made, push the [Cancel] button.
 22. After finishing the necessary setting for e-mail, push the [OK] button ㉗. To cancel the settings made, push the [Cancel] button.

System Settings Menu Operation

Screen 1 Simple Interlock

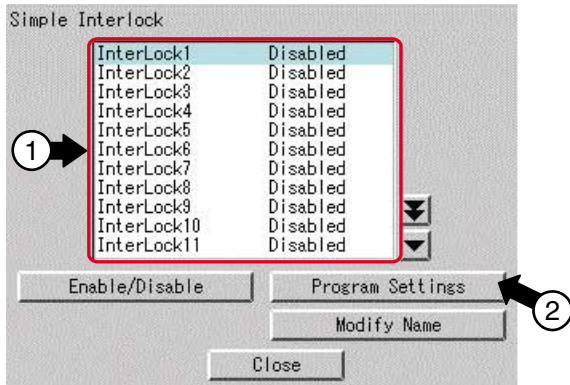

Screen 2 Program Settings

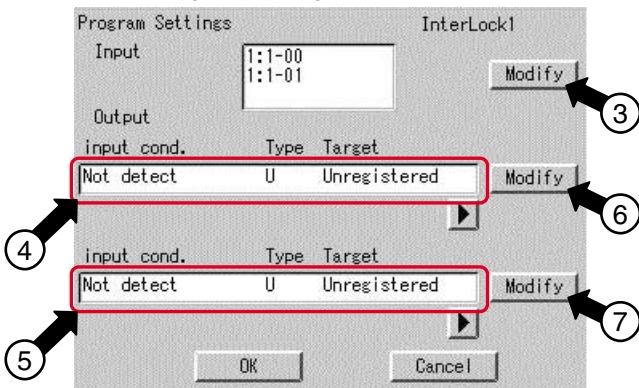

Screen 3 Events

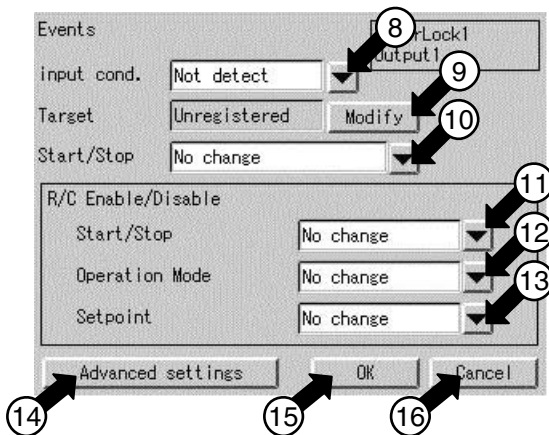

Simple Interlock

1. Following the steps on page 63, to select **Simple Interlock**.
2. As shown in the figure of the Screen 1 on the left side, the Interlock Setup setting screen will be displayed.
3. From ①, select a simple interlock program where you want change the settings.
4. Press the [Program Settings] button. (See ②) As shown in the figure of the Screen 2, the Program Setup screen will be displayed.
5. Press the [Modify] button. (See ③) Select a group/groups to be registered as the input points of the interlock function. The maximum number of 128 groups can be registered.
6. In the figure on the left side, ④ indicates the controlled items by the interlock output 1 and so does ⑤ by the interlock output 2. To change these settings, press either of the [Modify] buttons (⑥ and ⑦) according to your need.

The Screen 3 shows the Events screen for the output 1.

7. The information displayed in the boxes pointed by ⑧ to ⑬ is the current settings of the event.

The items to be able to set are described below, in ascending order of the number shown in the figure.

- input condition : In this box, select a condition for the interlock input point to initiate the interlock control function. From the pull-down menu (see ⑧), select either of Not detect / Any turned ON / All turned ON / Any turned OFF / All turned OFF.
- Target : In this box, select a target of interlock control. Press the [Modify] button to select Zone or Group. (See ⑨)
- Start / Stop : In this box, select an operation performed when the interlock condition is met. From the pull-down menu (see ⑩), select either of No change/Start/Stop.

Settings about operations of the hand-held remote controller

Start / Stop : From the pull-down menu (see ⑪), select either of Permitted / Stop only / Prohibited / Not change.

Operation Mode : From the pull-down menu (see ⑫), select either of Permitted / Prohibited / No change.

Setpoint : From the pull-down menu (see ⑬), select either of Permitted / Prohibited / No change.

- Advanced settings : Pressing this button (see ⑭) will move to the Screen 4 shown on the next page and display the Advanced settings screen. (This screen will be described on the next page.)

When the settings on this page and the advanced settings described on the next page are completed, press the [OK] button. Otherwise, to go back without changing any settings, press the [Cancel] button to go back to the Screen 2. To finish all the settings, press the [OK] button in the Screen 2.

System Settings Menu Operation

Screen 4 Advanced settings

8. In the Screen 3 Events on the previous page, pressing the [Advanced settings] (See 14) will display the Advanced settings screen shown in the Screen 4 on the left side. The information displayed in the boxes pointed by 17 to 20 is the current settings of the event.

- Operation Mode : In this box, select an operation mode specified to Zone or Group. From the pull-down menu (see 17), select either of Cool / Heat / Auto / Fan / Dependent / Dry / No change. Though the operation mode is set to Dry, some indoor unit with no change over option will not be changed to the Dry mode except in the cooling mode.

* Dependent can be used to order the indoor unit, without change over option in the VRV, to perform the temperature control operation other than the fan operation. When the interlock condition is met, this indoor unit will operate in the same operation mode as that of another indoor unit with change over option. For the same reason, even if the cooling / heating mode is set to an indoor unit without change over option, this unit operates in the same operation mode as that of another indoor unit with change over option. For detailed information about the change over option, please refer to the operation manual of the air conditioning unit.

- Setpoint : In this box, set a temperature of Zone or Group. Pressing the [Modify] button (see 18) will display the keyboard for registering a temperature, where you can input the desired temperature. The [Disable] button will be shown after pressing the [Modify] button once to set a temperature. Pressing the [Disable] button will cancel the temperature specified by the Modify operation described above.

To the HRVs included in the interlock operation targets, the settings described below can be made. However, this setting menu will be displayed even when the HRVs are not included in the targets, but any settings made in this menu will do nothing.

- Ventilation mode : In this box, set the ventilation mode. From the pull-down menu (see 19), select either of Automatic / Heat Exchange / Bypass / No change.
- Ventilation amount : In this box, set the ventilation amount. From the pull-down menu (see 20), select either of Auto (Normal)/Low (Normal) / High (Normal) / Auto (Freshen up) / Low (Freshen up) / High (Freshen up) / No change.

When the advanced settings are completed, press the [OK] button to go back to the Screen 3 shown on the previous page. Pressing the [OK] buttons in the Screen 3 and the Screen 2 continuously to go back to the Screen 1 shown on the previous page. The next step is to specify a name of the simple interlock, followed by the validity / invalidity setting. (Details of these settings will be described in the next page.)

System Settings Menu Operation

Screen 5 Simple Interlock

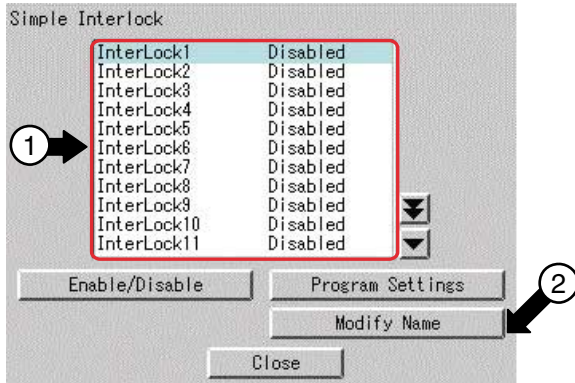

Simple Interlock Change Name

1. From the menu displayed on Page 63, select **Simple Interlock**.
2. As shown in the figure of the Screen 5 on the left side, the simple interlock screen will be displayed.
3. From ①, select a simple interlock program of which you want change the name.
4. Pressing the [Modify Name] button (see ②) will display the keyboard, where you can input the desired name of the interlock function. (The name of the simple interlock function can contain 16 characters maximum.)

Screen 6 Simple Interlock

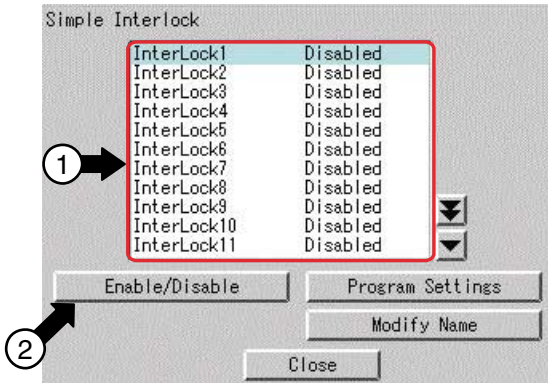

Simple Interlock Enable/Disable Setting

1. The last thing to do is to switch between the validity / invalidity settings of the simple interlock function. In the simple interlock setting screen shown in the figure of the Screen 6, follow the steps described below : From ①, select a simple interlock program for which you want switch between the Enable / Disable settings.

Then pressing the button ② will switch between the Enable / Disable settings.

In the confirmation screen displayed, press [Yes] to make the change effective or [No] to cancel the change.

See the indication of Enable / Disable on the right side of ① to check whether the setting you made is correctly reflected.

[Note]
Even if the Simple Interlock are made, they are not activated unless you select the Enable button.

System Settings Menu Operation

Screen 1 Version Information



Version Information

This is a menu for checking the version number of the software for the intelligent Touch Controller currently used. Generally it is not necessary to check.

1. From Screen 2(A) displayed on Page 63, scroll the menu and select **Version Information**.
2. Screen 1 Version Information, which is shown on the left, appears. The figure on the left shows an example. It may be different from the actual version.
3. When the version number has been checked, press the [Close] button ①.

Internal Battery Enable(ON)/Disable(OFF)Switch

The intelligent Touch Controller is equipped with internal batteries in order to run the clock during blackouts. The batteries can be enabled and disabled using the switches shown in the figure below.

The clock will not function properly when a blackout occurs if this switch is turned to OFF. The switches are turned to ON when the unit is installed. Do not touch them unless the power has been turned off for a long time. (See the next page for details on what to do if the power has been off for long periods of time.)

<Location and Setting of Switches>

As shown in the figure, set the battery switch on the left side of this controller to **OFF** (switch knob upper side) or **ON** (switch knob lower side), using a small blade screwdriver.

(Turning this switch OFF does not erase the settings for groups, zones or schedule.)

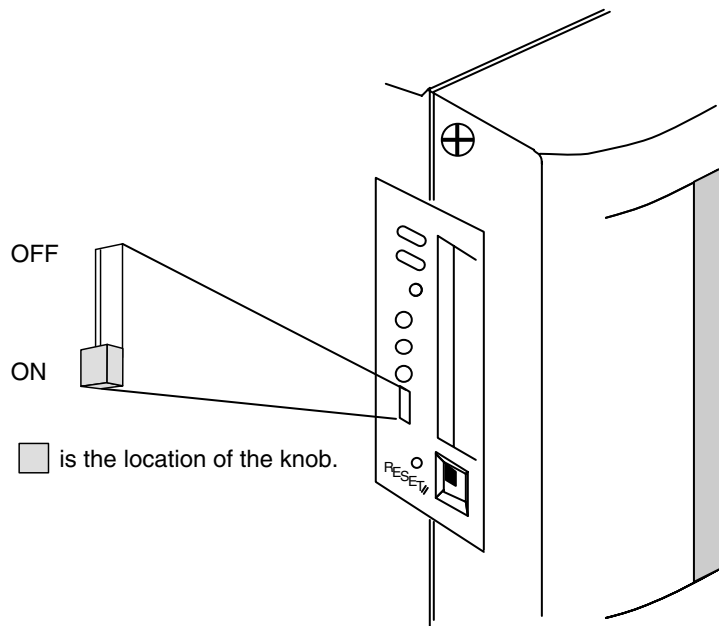

NOTE

- Do not touch other switches.
- Avoid turning the switch ON and OFF with excessive force; otherwise such operation may lead to parts damage and failure.

LCD Maintenance

- When the surface of the LCD or the main unit of the intelligent Touch Controller is soiled, wipe the soil off with a piece of cloth soaked in a diluted neutral detergent and wrung sufficiently.

Note

- Do not use thinner, organic solvent, strongly acid solution, etc.
The print may fade or wear out and discolor.
- Forced rubbing with hard cloth may cause damage to the liquid crystal display unit.
Remove stains, always using a soft waste cloth.
- If the unit is stored with water droplets and stains sticking to the liquid crystal display unit, a blot may be made and the coating may come off.

When Leaving the Product Turned OFF for a Long Time

When you leave the intelligent Touch Controller turned OFF for a long time (6 months or longer), turn the switch OFF to maintain the battery.

- The intelligent Touch Controller has a built-in battery for operating the clock in power failure.
The battery mentioned above is for power failure only and it may be completely discharged if no power is provided for a long time.
The capacity is worth about 2 years of in total if no power is supplied.
- To use the intelligent Touch Controller again, turn the switch ON.

[Setting the switch]

As shown in the figure, set the battery switch on the left side of this controller to **OFF** (switch knob upper side) or **ON** (switch knob lower side), using a small blade screwdriver.

Turning this switch OFF does not erase the settings for groups, zones or schedule.

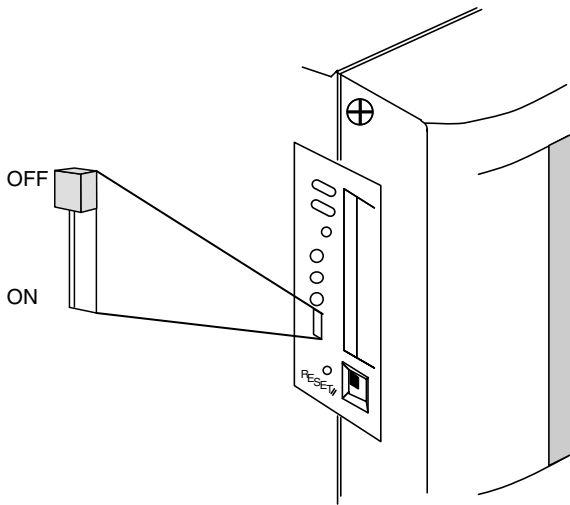

 is the location of the knob.

Note

- Do not touch other switches.
- Avoid turning the switch ON and OFF with excessive force; otherwise such operation may lead to parts damage and failure.

⚠ Caution

If electric components in the intelligent Touch Controller are charged with static electricity, it may cause failure.

Be sure to discharge the static electricity accumulated in your body before attempting any operation.

To discharge yourself, touch a grounded metal object (control panel, etc.).

Before Having the Product Serviced

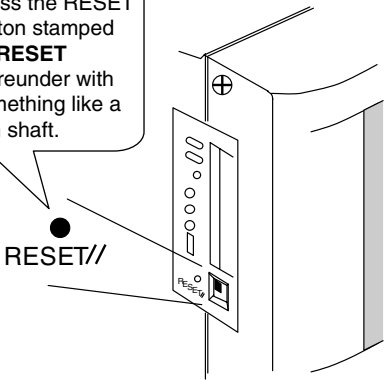
Item	Description and Corrective Action
The display of the intelligent Touch Controller has gone out.	When Backlight Auto OFF is set for Backlight of the intelligent Touch Controller, the light goes out if the screen is left untouched for a certain time. Touch the screen with the pen provided. The display comes back on.
The backlight does not go out when Backlight auto OFF is set.	Backlight Auto OFF is a function to automatically turn the backlight OFF if it is left untouched for a certain time. If the display is Configure / Details, System Settings, etc., the light does not go out automatically.
The intelligent Touch Controller cannot be operated or monitoring is not available.	<p>Press and hold down the RESET button on the left screen of the intelligent Touch controller for 5 seconds. Pressing this switch initialize the intelligent Touch Controller. Pressing this switch does not erase the settings for groups, zones or schedule.</p> <div data-bbox="577 782 765 948" style="border: 1px solid black; padding: 5px; width: fit-content;"> <p>Press the RESET button stamped as RESET thereunder with something like a thin shaft.</p> </div>  <div data-bbox="1081 898 1190 933" style="border: 1px solid black; border-radius: 10px; padding: 2px; display: inline-block;"> Note </div> <ul style="list-style-type: none"> ● Do not touch other switches. ● Avoid turning the switch ON and OFF with excessive force; otherwise such operation may lead to parts damage and failure. <p style="text-align: center;">intelligent Touch Controller</p> <div data-bbox="834 1246 985 1280" style="border: 1px solid black; border-radius: 15px; padding: 5px; display: inline-block;"> Caution </div> <div data-bbox="583 1265 1248 1464" style="border: 1px solid black; border-radius: 15px; padding: 10px; margin-top: 10px;"> <p>If electric components in the intelligent Touch Controller are charged with static electricity, it may cause failure. Be sure to discharge the static electricity accumulated in your body before attempting any operation. To discharge yourself, touch a grounded metal object (control panel, etc.).</p> </div>

Before Having the Product Serviced

Item	Description and Corrective Action
On the Monitoring screen, buzzer sounds when an area not allocated for a button for operation is pressed.	The intelligent Touch Controller is designed in such a way that the buzzer sounds when any part of the screen is pressed. It is normal.
The screen flickers at a regular interval.	While the Monitoring screen is shown, the screen is updated every 3 seconds to show the latest status of air conditioners. The screen may look flickering when the update is made. It is normal.
Touching the screen of the intelligent Touch Controller does not change the display soon.	Updating of the display may take some time depending on the communication status with the air conditioners connected. Update is completed in a few seconds.
LCD	There may be found some dots that are never illuminated or always illuminated on a certain part of the LCD of the intelligent Touch Controller. It is normal. The LCD may inherently generate unevenness due to change of temperature, which is normal.
On the Zone Monitoring screen of the intelligent Touch Controller, a filter or element sign was shown for a certain zone. Cleaning the filter or element of air conditioners and resetting the cleaning sign with a remote control does not turn out the filter or element sign.	On the Zone Monitoring screen, the filter or element sign shown is not turned out unless the filter or element signs for all of the air conditioners in the zone are reset. Check for any air conditioner showing cleaning sign apart from the air conditioners cleaned in the zone.
Pressing an operation button on the screen of the intelligent Touch Controller sounds the buzzer but operation is not accepted.	The positions of buttons on the touch panel may be shifted over time. See page 90 and perform touch panel calibration.
The intelligent Touch Controller does not allow setting of Permitted / Inhibited of the remote control.	When BAC net Gateway is connected, Permitted / Inhibited setting of the remote control cannot be made with the intelligent Touch Controller. When double intelligent Touch Controller control is performed, one of the two intelligent Touch Controllers cannot make Permitted / Inhibited setting.
An air conditioner to be connected to the intelligent Touch Controller has been added but the added air conditioner cannot be monitored on the Monitoring screen of the intelligent Touch Controller.	When adding an air conditioner to be connected to the intelligent Touch Controller, trial running of the intelligent Touch Controller, as well as of the air conditioner, is required. *When trial running of the intelligent Touch Controller has not been performed, contact our representative.

Before Having the Product Serviced

Item	Description and Corrective Action
<p>Collective Operation, Start and Stop buttons are not shown on the Monitoring screen of the intelligent Touch Controller and operation of air conditioners is made impossible.</p>	<p>Is the indication System Central controlled on the Monitoring screen, as shown below?</p> <p>This indication is shown in the following cases.</p> <p>When BAC net Gateway is connected to the intelligent Touch Controller, the low order control inhibit setting is available for DMS-IF, BAC net Gateway.</p> <p>The lower order control inhibit is a setting that inhibits operation of air conditioners from the intelligent Touch Controller central management controller and ON / OFF controller and enables commands from DMS-IF, BAC net Gateway only. When this setting is made, System Central controlled indication is shown on the intelligent Touch Controller.</p> <p>When the setting is released, the System Central controlled indication disappears and operation with the intelligent Touch Controller becomes available.</p> <div data-bbox="642 788 1197 1296" style="text-align: center;"> </div>

Before Having the Product Serviced

Item	Description and Corrective Action
<p>The air conditioner is supposed to operate, but it is stopped.</p>	<p>The followings are possible causes. Check the followings.</p> <ol style="list-style-type: none"> 1. Is the stop operation performed with the remote control of the air conditioner? 2. When a central unit is connected in addition to this unit, is the stop operation performed with the central unit? 3. Was the power supply for air conditioner interrupted? 4. Is the schedule of stopping the air conditioner registered with the schedule function of the unit? 5. Is Heating Mode Optimization function of this unit activated? The above function stops the air conditioner during the heating operation to prevent warm air when the thermo-switch is turned off. (For details, see pages 45, 46.)
<p>The air conditioner is supposed to be stopped, but it is operating.</p>	<p>The followings are possible causes. Check the followings.</p> <ol style="list-style-type: none"> 1. Is the start operation performed with the remote control of the air conditioner? 2. When a central unit is connected in addition to this unit, is the start operation performed with the central unit? 3. Is the schedule of starting the air conditioner registered with the schedule function of the unit? 4. Is Temperature Limit function of this unit activated? The above function operates the air conditioner automatically to avoid excessive increase or decrease of room temperature. (For details, see pages 42-44.)
<p>The set temperature or the operation mode of the air conditioner has been changed.</p>	<p>The followings are possible causes. Check the followings.</p> <ol style="list-style-type: none"> 1. Is the set temperature or the operation mode changed with the remote control of the air conditioner? 2. When a central unit is connected in addition to this unit, is the set temperature or the operation mode changed with the central unit? 3. Is the schedule of changing the set temperature or the operation mode registered with the schedule function of the unit? 4. Is Automatic Changeover function of this unit activated? The above function changes the operation mode and set temperature of the air conditioner automatically to maintain an optimum room temperature. (For details, see pages 37-41.)

Before Having the Product Serviced

Item	Description and Corrective Action
<p>Collective Operation, Start and Stop buttons are not shown on the Monitoring screen of the intelligent Touch Controller and operation of air conditioners is made impossible.</p>	<p>Is the indication System Forced Stop on the Monitoring screen, as shown below? This indication is shown in the following cases.</p> <p>When forced stop command is input to central management devices (central remote controller, ON / OFF controller, etc.) including the intelligent Touch Controller, the indication appears. Inputting forced command stops all air conditioners connected to the central management device. While the command is input, neither the central management devices nor remote controller can operate air conditioners.</p> <p>When the forced stop input command is canceled, the System Forced Stop disappears, which allows control with the intelligent Touch Controller.</p> <div data-bbox="628 722 1181 1238" style="text-align: center;"> </div>

Before Having the Product Serviced

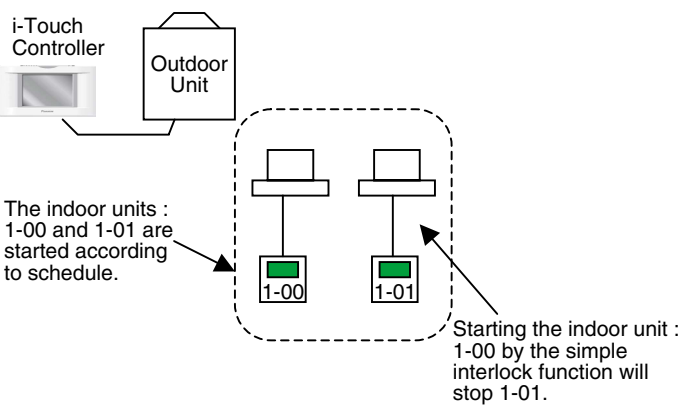
Item	Description and Corrective Action
<p>The air conditioning unit does not operate.</p>	<p>The air conditioning unit might be stopped by the simple interlock control function. Check the settings of the simple interlock function.</p> <p>In the case described below, the air conditioning unit : 1-01 will not operate. Once both units : 1-00 and 1-01 are started, then the unit : 1-01 will be stopped by the simple interlock control function.</p>  <p>The indoor units : 1-00 and 1-01 are started according to schedule.</p> <p>Starting the indoor unit : 1-00 by the simple interlock function will stop 1-01.</p> <p>In this case, even though the unit : 1-01 has been scheduled to be started, the simple interlock control function stops it. → It seems that the unit has not been started.</p>

Emergency Procedure for intelligent Touch Controller Failure

Item	Description and Corrective Action
<p>Failure occurs in the intelligent Touch Controller while the remote control is disabled with the intelligent Touch Controller and start / stop setting, etc., of air conditioners cannot be made.</p>	<p>As a temporary measure before our service personnel investigates into the problem, turn OFF the power supply breaker of the intelligent Touch Controller. This allows all kinds of operation with the remote control of air conditioners in about 5 minutes.</p> <p>When there is any other central management device, turn the power OFF for all of the devices.</p>

When it is desired to adjust screen brightness, contrast and buzzer sound level

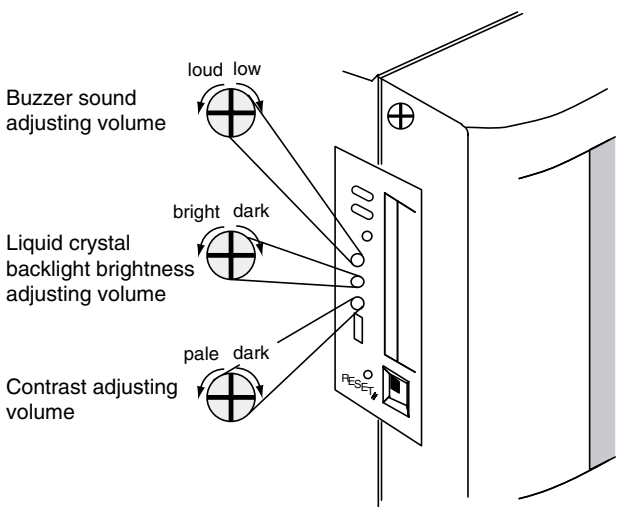
Item	Description and Corrective Action
<p>Screen brightness, contrast and buzzer sound adjustment is desired.</p>	<p>The screen brightness, contrast and buzzer sound level are factory adjusted properly before shipment, but in case where the screen is hard to see and the buzzer is hard to hear, for example, according to the actual installation condition and usage, the screen brightness, contrast and buzzer sound level can be adjusted by the following method.</p> <p>[Adjustment Method] Adjust the volume (variable resistor) on the left side of the intelligent Touch Controller with a Phillips head screwdriver while checking each level. The buzzer sound, screen brightness and screen contrast volume switches are located in sequence from the top as shown below.</p>  <p>Note</p> <ul style="list-style-type: none"> • Since each volume is a precision component part, do not turn the volume switch with excessive force. It should be noted that a fault is caused to the switch. • Do not touch other switches. The buzzer volume and liquid crystal backlight brightness can be adjusted with the volume switch as described in the diagram above, but adjustment is usually not necessary. <p>Caution</p> <p>If electric components in the intelligent Touch Controller are charged with static electricity, it may cause failure. Be sure to discharge the static electricity accumulated in your body before attempting any operation. To discharge yourself, touch a ground metal object such as a control panel.</p>

Connecting Unification adaptor allows using the contact for normal and abnormal operation signal and collective start/stop with a contact. For details, contact the vendor you purchased the product from. Also, by connecting D III NET-plus adaptor, it is possible to operate and monitor the indoor units of 64 groups (intelligent Touch Controller plus D III NET – plus adaptor–128 groups in total) additionally.

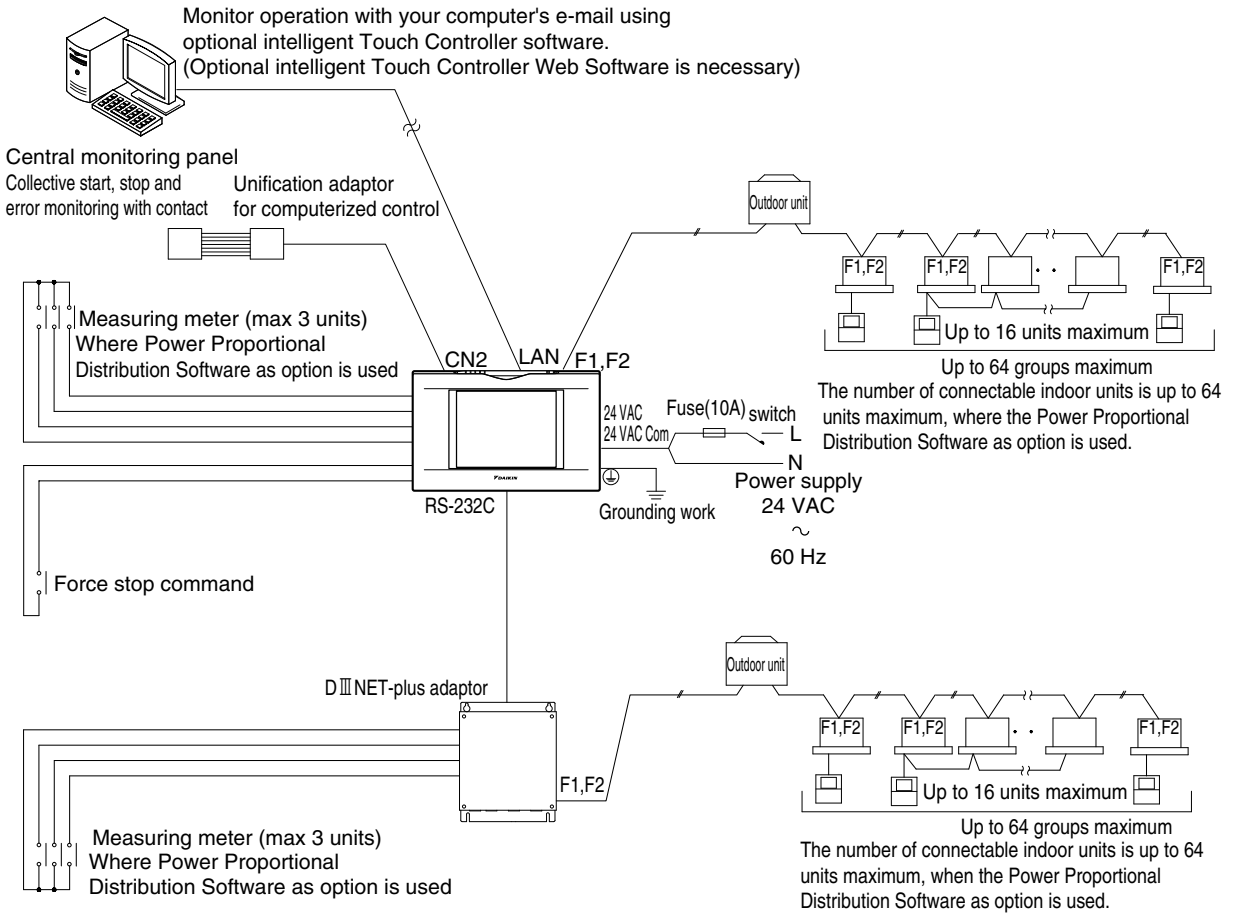

Specification

Specification

Power	AC24V 50/60Hz
Power consumption	10 W maximum
Force stop input	Normally-open contact Contact current approximately 10 mA
Size	$9\text{-}1/16 \times 5\text{-}25/32 \times 4\text{-}7/32$ (W × H × D)
Mass (Weight)	2 lb 10 oz

Dimensions

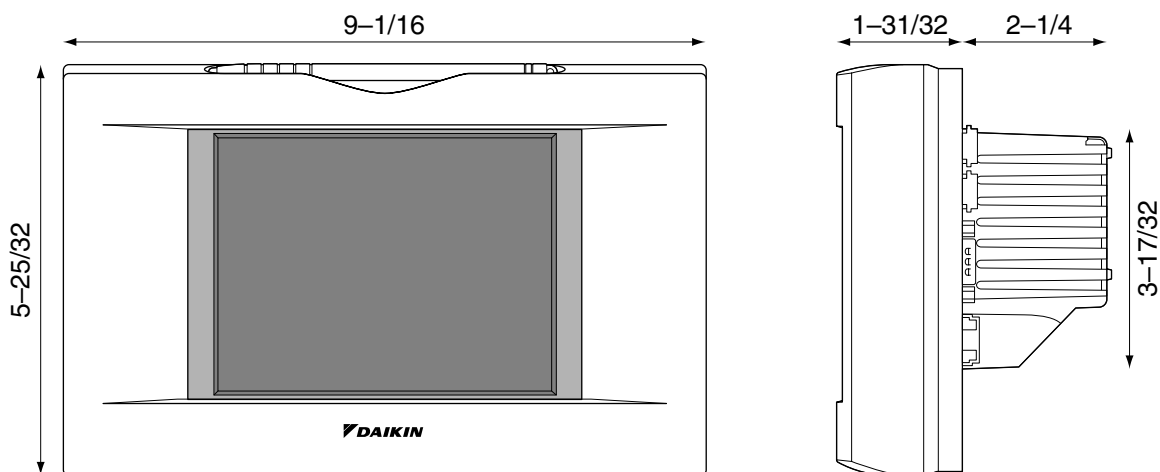

The specification and appearance of the product may be modified for improvement without prior notice.

After-sales Service

- To have the product repaired, prepare the following information

- Model
- Date of installation
- Circumstances - as detailed as possible
- Address, name, phone number

- **Transfer**

Transfer requires professional technique. Be sure to contact the vendor you purchased the product from or service station.

The customer will be charged for the expense required for transfer work.

- **Repair after the guarantee period for free repair**

Contact the vendor. When the functions can be maintained by repair, the product will be repaired according to the request and the customer will be charged.

(Guarantee period ... one year from the date of installation)

- **Questions**

For after-sales service, contact the vendor you purchased the product from or the nearest service station.

DAIKIN AC (AMERICAS), INC.

1645 Wallace Drive, Suite 110
Carrollton, TX 75006

info@daikinac.com
www.daikinac.com

DAIKIN INDUSTRIES, LTD.

Head office:
Umeda Center Bldg., 2-4-12, Nakazaki-Nishi,
Kita-ku, Osaka, 530-8323 Japan

Tokyo office:
JR Shinagawa East Bldg., 2-18-1, Konan,
Minato-ku, Tokyo, 108-0075 Japan