

H A S S E L B L A D



User Manual

H2F

C O N T E N T S

Introduction	3	Darkslide indicator	28	9 Advanced Features	49
Parts & Components	6	Darkslide key	28	General overview of camera menu	50
1 Function Control & Display	8	Film tab holder	28	Self Timer	51
Grip LCD	10	Film holder key	28	Bracketing	53
Viewfinder LCD	12	Magazine settings lock	28	Interval	55
2 Camera Body	17	Databus interface	28	Settings	56
Carrying strap	18	Magazine operation	28	Custom Options	56
Battery holder	18	Battery	29	Image Info / Imprint type	61
Fitting batteries	18	Battery replacement	29	Text	62
Battery life	18	Attaching and removing the magazine	29	Date & Time	64
Viewfinder screen	19	Magazine settings	30	System status	65
Accessory connection	19	Film speed setting	30	Digital	66
PC-connector	19	Film speed setting / Barcode	30	Customizable button function list	67
Protective base plate	19	Film length/number of frames	30		
3 Viewfinder	20	Data imprint setting	31	10 Flash	68
Parts & Components	21	Frame counter setting	31	Flash measure	71
Attaching and		Low-battery symbol	31		
Removing the viewfinder	21	Film loading	32	11 Optional Accessories	72
Eyepiece adjustment	21	Film wind off	32		
Eye cup	21			12 Appendix	75
4 Lenses	22	6 Digital Photography	33	Glossary	76
Parts & Components	23	7 Light Metering &		Technical specifications	80
Attaching a lens	23	Exposure Control	36	Equipment care and service	84
Removing a lens	23	Metering method	37		
Lens cap	23	Exposure method	38		
Filters	23	Manual exposure mode	38		
Lens shades	23	Automatic exposure mode	39		
Shutter and aperture control	23	AE-L button	40		
Depth-of-field calculation	24	Exposure compensation	41		
Depth-of-field / visual preview	24				
Infrared focus settings	24	7 General Functions	42		
Focus aid	24	Power-ON	43		
CF adapter	25	Power-Standby	43		
Specific-lens information	25	Power-OFF	43		
5 Film Magazines	26	Manual focus	43		
Parts & Components	27	Manual focus mode	44		
LCD panel	27	Autofocus override in manual mode	44		
LCD illumination button	27	Autofocus	44		
Change up button	27	Single Shot	44		
Change down button	27	Continuous	45		
Function selector	27	Autofocus mode	45		
Film plane index	28	Drive	46		
		Single	46		
		Continuous	46		
		Multi exposure	46		
		Profiles	47		
		Making a profile	47		
		Changing a profile name	48		

H A S S E L B L A D

H2F

Welcome to Hasselblad!



Hasselblad had its beginnings during the last fifty years of the last millennium. Within twenty years it was present as mankind took the first small step on the moon. Now, Hasselblad has made its own giant leap forwards into the future by developing the H system. It is a new foundation on which to build, ensuring the utmost in image-quality, handling and versatility resulting from the most reliable and efficient solutions to meet photographers' expectations.

The specifications and capabilities of the H system exceed the demands of most photographers. This allows the system to expand and develop. It's one of the reasons that so many professional photographers around the world are discovering, or re-discovering, the creative and professional possibilities provided by the Hasselblad system.

The H system is the result of the most intensive technical development programme ever undertaken by Hasselblad, the most prestigious medium-format camera manufacturer in the world. It reflects an unprecedented wealth of knowledge and experience tightly interwoven with the latest technological developments that combined to produce an unrivalled world-class creative tool for the discerning photographer.

The H2F offers the best choice in a medium format platform where maximum choice of capture method or make is first on the list. Regarding features, what was once considered optional is now integral. The potential of this outstanding professional equipment straight out of the box is tremendous.

But there is no trade-off in quality for the sake of the latest technology. The three pillars of the Hasselblad reputation remain: Reliability, Versatility, Interchangeability. Stainless steel and aluminium for no-nonsense professional use and durability. Silicon chip control for basic practical support as well as sophisticated facilities to span all demands. A system to trust and build on, that will develop and grow in pace with tomorrow's discoveries.

The list of features is long, varied and comprehensive. For example: automatic focus with instant manual override, dot-matrix LCDs, rapid button and control wheel user interface, integral grip, integral fill-flash, multi-mode exposure metering, TTL flash control, automatic film speed setting with bar code, instant 120/220 interchangeability, integral dark slide, automatic film advance and film wind off, custom imprinting on frame edge including exposure data, name, symbols, etc., immediate cable-free compatibility with digital backs, presentation of digital information such as histograms and grey balance on the LCD, extremely accurate electronic leaf shutter, flash sync at all shutter speeds to 1/800s, eyeline viewfinder with 100% view, dot matrix viewfinder LCD, lithium or rechargeable battery options, shutter speeds from 18



What's in the box

Your new Hasselblad camera may have been supplied in kit form or as separate items. There are a number of possible combinations depending on factors such as offers, bundles etc. Please ensure that all the items noted on the accompanying packing information have been supplied and are correct.

Contact your Hasselblad dealer or distributor immediately if anything is missing or seems faulty in any way, quoting the serial numbers and purchase details where appropriate.

Familiarise yourself with the various parts and components. Leave protective covers on as much as possible and avoid touching glass surfaces and inserting fingers into the camera body. The H2F has a robust construction and is capable of withstanding fairly rough treatment but nevertheless is a precision instrument and will serve you longer if treated with respect from the beginning.

Please keep purchase details and the warranty in a safe place.



Parts & Components

1. Flash unit hot-shoe
2. Rubber eyecup
3. Exposure mode and metering method selector button
4. Exposure compensation button
5. Eyepiece adjustment dial
6. Magazine LCD
7. Magazine LCD illumination button
8. Magazine control buttons
9. Magazine settings lock
10. AE-L button
11. Film wind-off button
12. User button
13. Rear control wheel
14. Grip LCD
15. Support strap lug
16. Camera control buttons
17. Magazine databus
18. Front control wheel
19. Shutter release button
20. Battery holder button
21. Release cord socket
22. Stop down button
23. Battery holder retaining lever
24. Mirror up button
25. Battery holder
26. Flash unit
27. Viewfinder screen
28. Focus assist light
29. Mirror
30. Distance and depth-of-field scales
31. Focusing ring
32. Lens shade bayonet
33. Filter screw thread
34. Databus connection
35. Viewfinder release button
36. Flash unit catch
37. Viewfinder attachment hook
38. Viewfinder databus connection
39. Magazine release button
40. Flash PC socket
41. Camera strap lug
42. Lens release button
43. Magazine support
44. Databus connection
45. Quick coupling tripod plate
46. Film tab holder
47. Magazine darkslide key
48. Film holder key
49. Magazine support groove
50. Databus connection

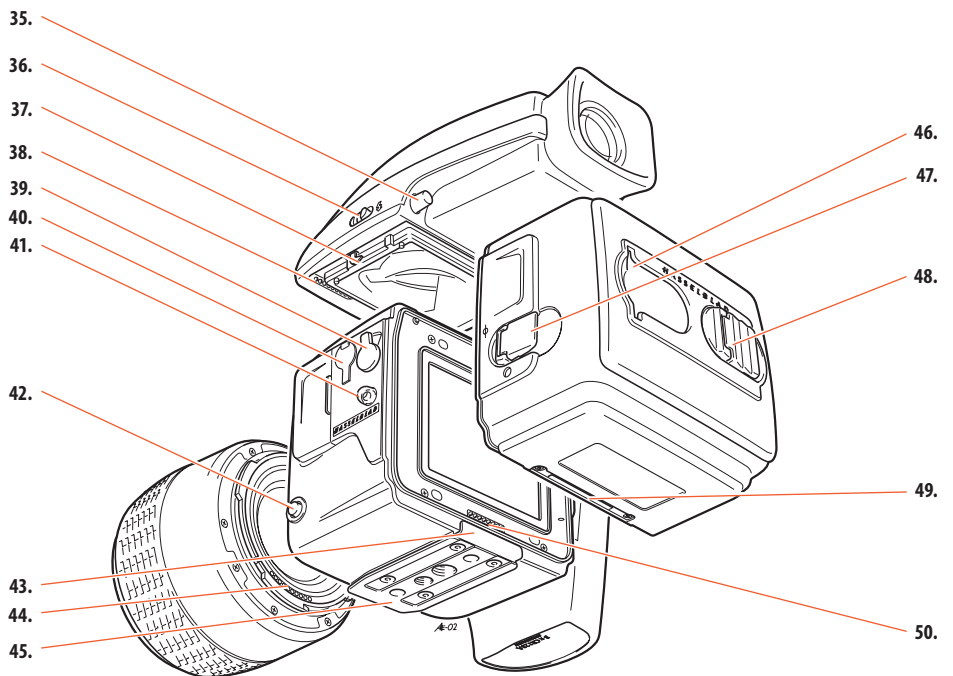
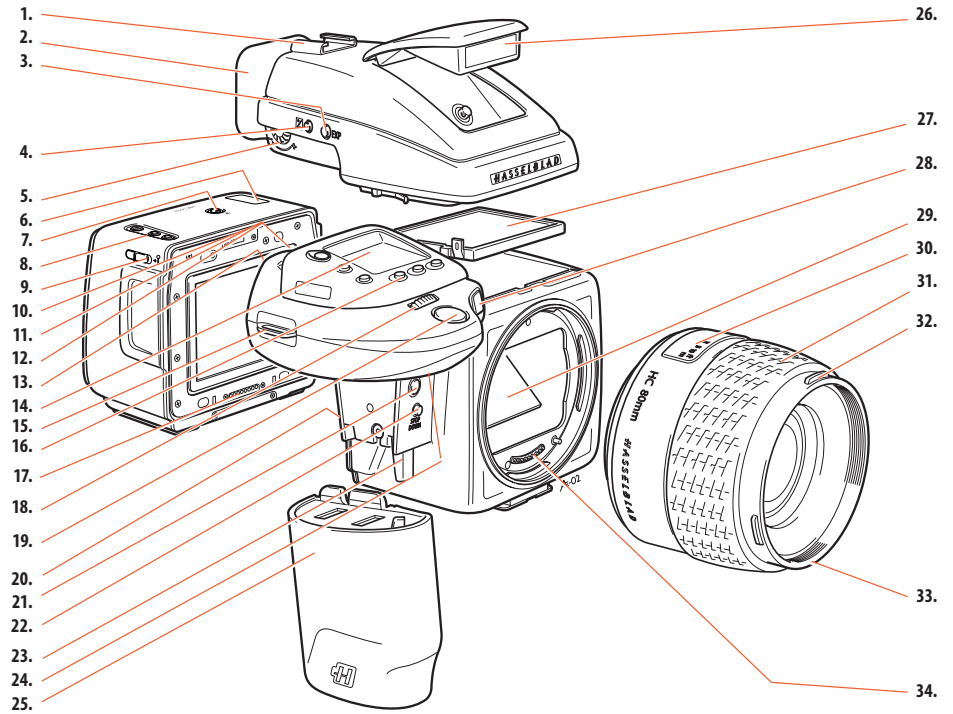



Familiarize yourself with the H2F

Take a few minutes to familiarize yourself with the H2F and its various controls. Note the difference between a long press, a short press and a 'click' with some buttons. For example from the main screen a click of the ON.OFF button will take you to Profiles while a longer press will turn the camera off.

With your right hand holding the ergonomic grip for security and control, your thumb and fingers have immediate access to all the controls without letting go. The H2F sits comfortably in the palm of your left hand for support but leaves your fingers free for eventual manual focus adjustments.

Note the changes on the LCD as you press the various buttons and rotate the control wheels. Notice too the changes in the viewfinder LCD as you do the same. You cannot damage the camera by pressing the wrong buttons or controls or using them in the wrong order. The worst that can happen is that you might get 'lost' in the menu or you might activate a certain action that takes time to complete. In this case simply click on the escape button (ON-OFF - PROFILES / ESC) to return to the 'main' screen again.

Attempt a half-press with the shutter release button with the camera set at autofocus too see how the lens focuses and the light metering reacts. Notice that the lens barrel does not revolve in autofocus but you can immediately change the focus manually and immediately revert to autofocus again by using a half-press again.

Note the readily accessible customizable buttons that provide direct access to most functions (investigate how you can exploit this excellent function to the full in a later section).

Note the safety features integral in the magazine so you cannot remove a magazine without the darkslide in place or (unless set otherwise) make an exposure with the darkslide in place.

Feel for the stop down button positioned between the lens and the grip.

Press the AF button and then turn the front control wheel to change from AF single to AF continuous to Manual to try out the differences in how the camera behaves in these different modes, for example.

Press the EXP button on the viewfinder and then turn the rear control wheel to change the metering method to see the changes in sensitivity of the exposure meter.

Quite simply, just explore the camera for a little while to feel at home with the general handling and the idea of control buttons and wheels and LCD information, etc. The sooner you become accustomed to moving the controls instinctively the sooner you will be able to effortlessly use the finesses on offer.

The remainder of this manual will slowly take you through, stage for stage, each feature and setting so that you can master this marvellous piece of photographic equipment and exploit it to the full.

Finally, remember to check occasionally with your camera dealer or on the Hasselblad website to see whether a firmware update is available. The functions and options described in this manual refer to the firmware version the camera was shipped with. The ability to update camera firmware is an advantage you should not forget to make full use of to maximize the capabilities of your H2F!



1

Function Control & Display

- LCD display on camera
- LED display on viewfinder
- Upgradeable firmware
- Rapidly accessible menu
- Interactive display
- Customizable functions

All functions and settings on the H2F camera body are accessed and altered by the control buttons and wheels on and around the grip aided visually by the LCD user-interface.

The information on the grip LCD is in menu format and has a great deal in common with those found in modern computers, cell phones, etc. It is pixel based and therefore has a greater capacity to produce user-friendly symbols for rapid and secure interpretation.

H2F

Below is an overview of the primary functions of the control wheels and buttons. Some controls have dual or triple functions according to the state of the menu or setting. A full description can be found further on in this manual.



Shutter release button

Activates camera and releases shutter.

FLASH / (CONTROL LOCK) button

Lock settings to avoid inadvertent change. Also accesses flash settings.

AF button

Accesses focus modes.

DRIVE button

Accesses the various drive (film frame advance) modes.

Front control wheel

Accesses and changes various settings.

MENU button

Accesses menu.

Illumination button

Illuminates grip LCD.

ON.OFF (PROFILES/ESC) button

Turns the camera on and off. Accesses Profiles and acts as escape button for other functions.

Rear control wheel

Accesses and changes various settings.



M.UP button

Raises and lowers mirror. Can be reassigned to another function.

Remote release cord port

For attaching a remote release cord (electrical).

STOP DOWN button

Stops down aperture to current setting. Can be reassigned to another function.



AE-L button

Locks light reading made in both automatic and manual exposure modes. Can be reassigned to another function.

Film wind-off button

Winds off film before film is finished.

USER button

User assignable-function button.



Eyesight correction adjustment wheel

Personal eyesight adjustment facility.

EV correction adjustment button

Produces EV compensation.

EXP button

Accesses exposure mode and metering method.

Grip LCD

Typical camera grip display. (The information in brackets describes this particular example).

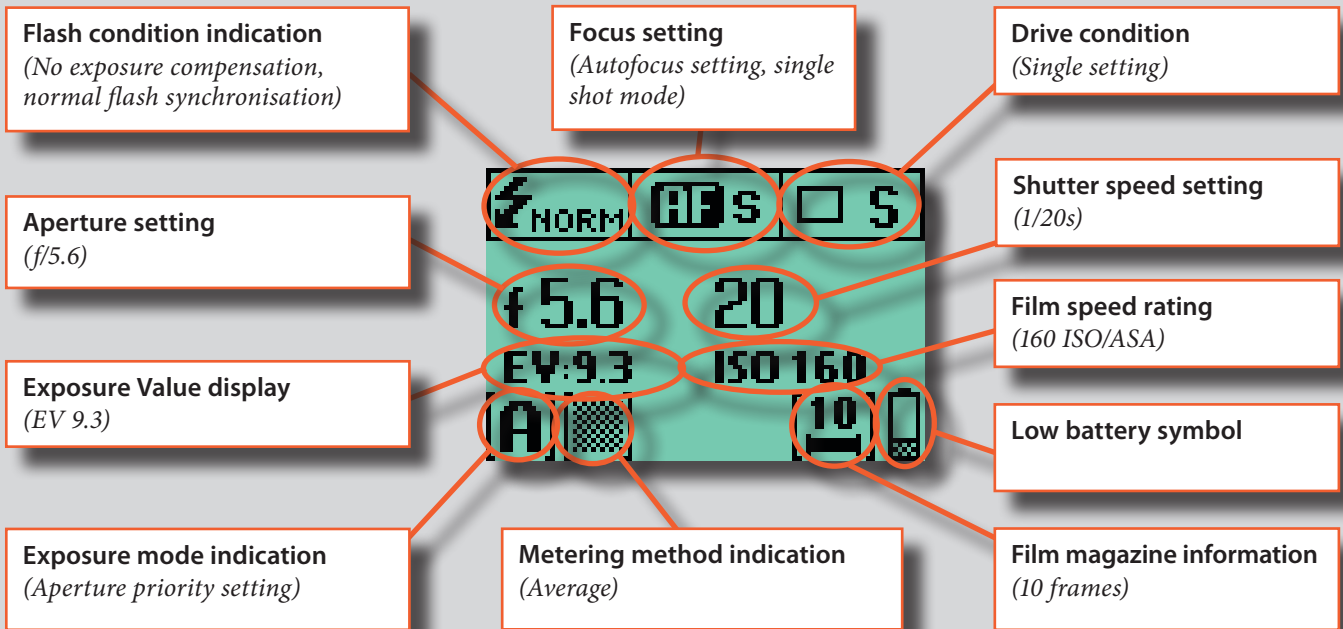

Typical camera grip display when changing settings.

Command indication
The upper row on the screens describes commands (which change according to the setting). The button immediately above each command effects the change. So in this case, for example, you would press the FLASH button to 'exit' from the screen. See note below.

Settings symbols
Symbolize the options available when settings are changed. The active symbol is depicted by a drop shadow.



Control wheel description and direction
Arrowheads symbolize which control wheel should be used to change the setting they are beside. In this case, the Bracketing option is chosen by the front control wheel and the number of exposures in that option is chosen by the rear control wheel.

◀...▶ = front control wheel
 ▲ = rear control wheel

Setting information
The lower row on the screen displays information about the current state of the setting. In short, the upper row displays what you can do, and the lower row displays the current state of settings or what you have done.



The basic principle behind making changes is that the appropriate button is first pressed to access the menu and then settings altered by way of the control wheels. The appropriate control wheel is designated by arrowheads alongside the setting description.

-  Some buttons have a toggle function, the ON.OFF button has a quick 'click' action as well as a longer (half-second) 'press' action and the shutter release has two positions: 'half-press' and 'full-press'.
-  Several buttons on the grip are multifunctional, according to the state of the menu. In the example illustrated here, the FLASH button functions as the EXIT button, the AF button functions as the ON button and the DRIVE button functions as the SAVE button.
-  At very low temperatures the LCDs require a few seconds to display new settings.

Examples

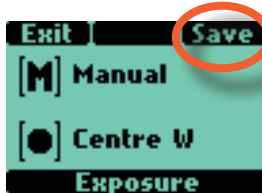

The following is a list of the various terms describing the various actions that appear in the menu (on the grip LCD):

- Enter** : moves screen down one level on the menu.
- Exit** : moves screen back up one level on the menu. Does not save any settings.
- Off** : deactivates the particular function being set.
- On** : activates the particular function being set.
- Sel.** : (Select) - selects the character marked for image info and profile name
- ESC** : (Escape) - terminates an action and returns to the main screen. Does not save any settings.
- Save** : saves a setting and also moves screen back up one level on the menu. Can save many changes made in a setting sequence.

Remember the following groupings of 'saved' and 'not-saved' actions when making settings changes:

SAVED	NOT SAVED
'Quick save' - half-press shutter release button	Escape - press ESC button (PROFILES/ESC button)
Save - press save button (DRIVE button)	Exit - press exit button (FLASH button)

Viewfinder LCD

Typical viewfinder display. Note the LEDs will only be visible when activated (by the camera or a setting).
 (The information in brackets describes this particular example).

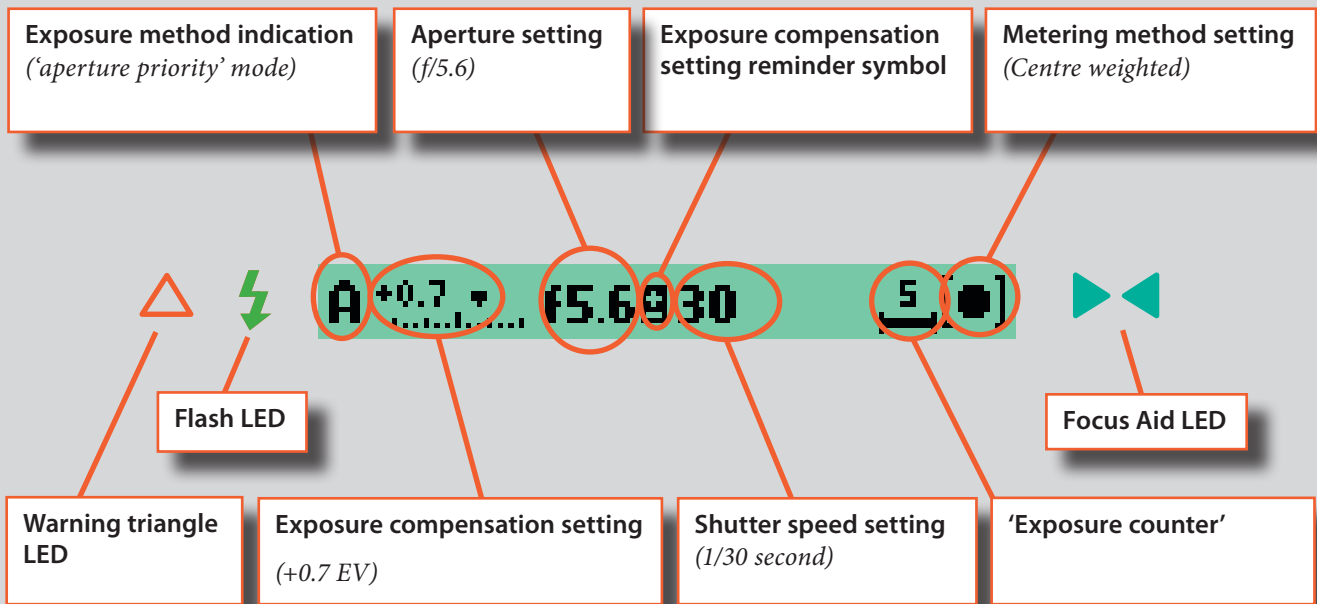

Some examples of various viewfinder LCD screens visible with standard settings and when specific control buttons are pressed.

Standard settings			
	Normal screen	Normal screen in AE lock state	Normal screen with exposure compensation set
FLASH			
	Flash mode		
AF			
	AF mode		
DRIVE			
	Drive mode		
MENU			
	Menu mode		
+/-			
	Exposure compensation mode		
EXP			
	Exposure method and metering method		

Menu charts – general

Throughout this manual you will find charts to explain the steps and procedures required to alter the various settings. These charts are laid out to graphically illustrate in a simple manner how to navigate through the menus. While they include all the information that would be presented on the LCD relevant to that section, they cannot illustrate all the possible combinations of the various symbols seen on a screen at one time as that would be impractical and too confusing. If you are at all familiar with cell phone menus, for example, then the design of the layout and working practice will not be unfamiliar.

You should find that, in practice, working your way through a menu on the camera is a good deal simpler and more obvious than the written explanation implies!

In the descriptions, various terms are used regarding menu navigation. Menus have 'trees', for example, which describes their imaginary graphical layout where you could trace a navigational path along its 'branches'. Each new section, or stopping off point on the branches, seen on the LCD is called a 'screen'. Therefore a screen is the graphical display on the LCD of where you are on the menu and represents the current state of settings.

The H2F features the advantage of multiple customization of settings. This means that your personal choice of settings, and thereby appearance of various combinations of symbols on the LCD at any time, will not necessarily be the same as many of the screens illustrated in this manual.

To simplify the descriptions, reference is often made to a 'main' or standard screen. Apart from default settings, there is no actual standard setting in the normal sense and therefore you create your own 'standard', which of course can be changed at any time.

The 'main' screen is therefore the one you have currently created and is the one visible on the LCD when photographing (except where a particular mode is in actual operation, such as self-timer, for example).

Symbols used in the charts



Use front control wheel
(direction depends on user setting)



Use rear control wheel
(direction depends on user setting)



Press button or turn wheel



MENU button on the grip



Choose ENTER
(by pressing DRIVE button on grip)



Choose ON
(by pressing AF button on grip)



Choose Save
(by pressing DRIVE button on grip)

The new setting will be saved and chosen action can be carried out. Setting will be retained until changed.



Functions in loop on menu

A loop means that the available functions on that particular branch of the menu can be successively accessed in either direction of the control wheels without a break in flow. That is, you could turn the wheel clockwise or anti-clockwise to arrive at the desired function.



Main direction of path through menu

The main path traces step-by-step the path that has to be taken through the various branches of the menu tree as they appear on the LCD to reach the relevant functions.



Shutter release button A

This button has *half-press* and *full-press* positions. By pressing half-way (or softly) the camera, auto focus function and exposure meter can be activated. By pressing all the way down (or more firmly) the shutter will be released (or the chosen exposure procedure will begin, as relevant. For example, the self timer is activated with this button)

FLASH / (CONTROL LOCK) button / (EXIT) B

This is a triple function button. If you press the button for one second, the beeper will sound (if set) and a key symbol will appear on the grip LCD signifying that the controls (except the shutter release) have been locked and therefore cannot be altered unintentionally in use. Press the button for one second again to unlock (this function can be altered to lock all controls or control wheels only in 'Custom options').

Quickly clicking the button will access the flash settings information on the LCD from the main screen. See separate section for full details.

This button also acts as the **EXIT** button for many other settings.

AF button / (ON) / (SEL.) C

This is a triple function button. Press this button to go directly to the autofocus/manual focus choice screen from the main screen. See separate section for full details. It also acts as the **ON** and **SEL.** (= select) buttons for many other settings.

DRIVE button / (SAVE) / (ENTER) D

This is a triple function button. It will access the drive settings screen on the LCD from the working screen. See separate section for full details.

It also acts as the **SAVE** and **ENTER** buttons for many other settings.

Front control wheel E

The front and rear control wheels are turned to make changes in exposure settings in the main screen as well as to access the various loop sections of the menu for settings. The effect of the wheels' direction is programmable.

MENU button F

Accesses the first level of the menu for settings changes.

Illumination button G

Press to illuminate the LCD. Remains active until camera enters standby mode.

ON.OFF (PROFILES/ESC) button H

Press the button for a half second to activate the camera. The H2F start-up logo will appear and then the main screen. After a few seconds (customizable) the camera will enter Standby mode. A press of the button will turn the camera off completely whereas a quick 'click' on the button will access the Profiles section of the menu from the main screen.

Note the difference in results between a long press and a quick click of the this button.

Rear control wheel I

The front and rear control wheels are turned to make changes in exposure settings on the main screen as well as to access the various loop sections of the menu for settings. Acts as quick access exposure compensation control. The effect of the wheels' direction is programmable.



On the rear of the grip, as well as the rear control wheel, there are a further three control buttons:



AE-L button

J

This button can lock a light reading made in both automatic and manual exposure modes. It can also be used in Zone mode to take a new reading.

Can be reassigned in Custom Settings to another function.

See section on the AE-L button (chapter 8, Light Metering and Exposure Control) for full details.

Film wind-off button

K

Pressing this button will automatically wind-off the remaining unexposed film rapidly without having to go through the normal film advance / expose cycles to reach the end of the film. The button has been purposely designed to avoid inadvertent pressing, so use the tip of a ball-point pen or similar to activate it. The grip LCD will display a message which you must confirm before this procedure is carried out.

USER button

L

This button is purely user programmable to rapidly access a chosen function or screen. For example, you might use bracketing a great deal and so by one press of this button you could access the bracketing function without having to navigate through the menu. The AE-L, Mirror-UP and Stop Down buttons are also user-programmable but are by default assigned the functions according to their names

 *The reassignable capability of these buttons is particularly useful and can save you a great deal of time and effort depending on how you work. You are advised to investigate their potential fully. See under 'Custom settings' for full details.*

On the front of the grip there are two more control buttons plus the remote cord release port:

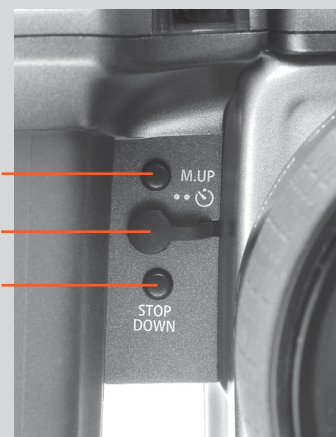

M.UP button

M

Press this button to raise the mirror and press again to lower it (toggle function). A quick double press of the button (two within a half second) will immediately access the 'Self timer' function.

Can be reassigned in Custom Settings to another function.

Remote release cord port

N

For attaching a remote release cord (electrical). The Hasselblad accessory jack plug socket is protected by a captive rubber plug.

STOP DOWN button

O

Press this button to make a visual check of the depth-of-field on the viewfinder screen at the chosen aperture. The aperture will close according to the setting and remain closed as long as the pressure is maintained. You can alter the aperture at the same time to see the changes taking place.

Can be reassigned in Custom Settings to another function.

There are also two control buttons on the viewfinder, as well as the eyesight correction adjustment wheel:

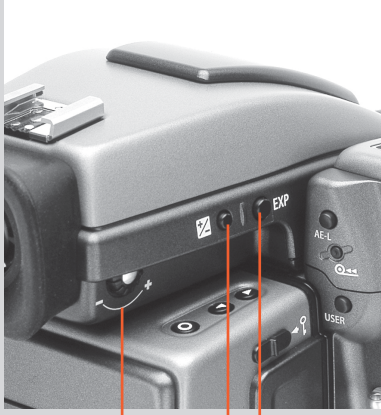

P

Q R

Eyesight correction adjustment wheel

P

The personal eyesight adjustment facility has a diopter range of -4 – +2.5, to suit most users.

EV correction adjustment button

Q

Press this button to access the EV compensation screen. Settings are made with either the front or rear control wheels. An EV correction symbol appears on the grip and viewfinder LCD as confirmation.

EXP button

R

The **EXP** (Exposure) button accesses the exposure mode and metering method options screen. Settings are made with the front and rear control wheels and the appropriate symbols appear on the grip and viewfinder LCD accordingly.

2

Camera Body

- Aluminium cast in one piece
- Stainless steel shell
- Integral Quick coupling plate
- Upgradeable software
- Modular design
- Integral ergonomic grip
- Pixel based LCD user interface

The H2F camera body is a robust construction of cast aluminium with a stainless steel shell for extreme durability. The workings of the camera are controlled by silicon technology that provides tremendous opportunities for sophisticated operation. For example, mirror return is slowed down at the last moment by controlling the motor. Usage status of the camera body is automatically recorded for service intervals and so on.

The integral ergonomic grip houses the main control interface and also contains the battery holder. An auxiliary shutter in the rear opening of the camera body protects the sensor unit from exposure during the various camera procedures. The camera body also contains the viewfinder screen, which can be easily removed or exchanged without the use of special tools or adjustment procedures.

Please take extra care when handling the camera body without a protective cover or film magazine to protect the auxiliary shutter. Likewise, the front opening of the camera body reveals the mirror when unprotected by a cover or lens. Do not touch or attempt to clean the mirror yourself—marks or dust particles will not affect results in any case. More noticeable problems, however, should be taken care of by a Hasselblad Authorized Service Center.

H2F

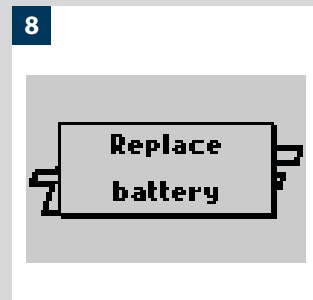
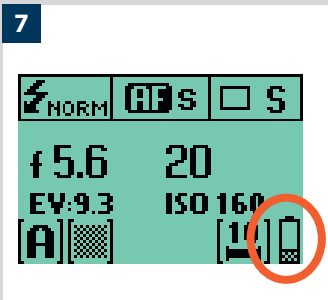
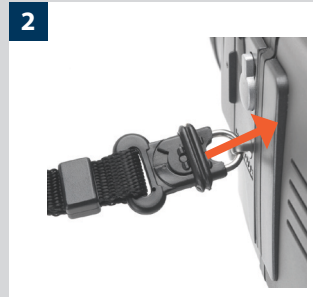
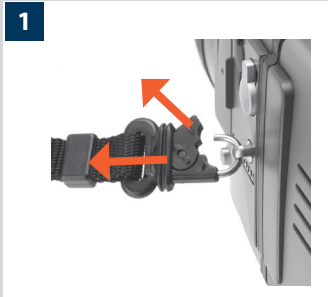

Carrying strap

1, 2

The carrying strap is attached by firstly withdrawing the safety collar. The hook is then freed and attached to the strap lug (fig. 1). Slide back the safety collar (fig. 2) to ensure the hook remains in the locked position between the small protruding lugs. The collar is purposely a tight fit and might need some effort to slide.

Removing and attaching the battery holder

3

The H2F requires batteries for all actions. There is no mechanical reserve facility so it advisable to always have a spare set of batteries. As is normal, you might want to keep a reserve set of batteries in a warm place when working in very cold conditions.

Remove the battery holder by depressing the the battery holder button (A) and simultaneously swinging the battery holder retaining lever (B) down until it stops. Pull battery holder downwards (C).

To attach ensure the battery holder is flat against the camera grip and, aligning the two upper lugs with the slot in the grip, slide it back into position as far as it will go. Swing back the battery holder retaining lever until it clicks back into place.

Fitting the batteries

4, 5, 6

With the battery holder removed, press the red battery cassette retaining button inwards on the holder to release the battery cassette. Load three CR-123 lithium (or equivalent) into the cassette, ensuring the polarity of each battery is correctly oriented (see the '+' markings on the batteries and the cassette). Re-insert the cassette into the battery holder, ensuring that it is seated properly in place and that the red button returns fully into the locked position.

Battery life

7, 8

Battery life is dependent on a number of variable factors and therefore cannot be exactly predicted. If the camera is left in the active state instead of standby for long periods, for example, then battery life will be reduced. A low-battery state is indicated as a symbol on the grip LCD.

When the batteries are almost completely exhausted, a warning message 'Replace battery' will appear on the grip LCD (fig. 8). The camera will not function at all when this message appears and battery change is essential.

When the 'replace-battery' icon appears, the camera automatically enters a temporary power-saving mode. This is recognizable by a slower pace for all the actions in an exposure sequence. The camera actions also sound differently.

This mode is designed so that you can continue working for a while, even though the batteries are too low for working in the normal manner. Naturally, you should change the battery pack as soon as possible to restore normal action again.

14



15



Viewfinder screen

14, 15, 16

The H2F is fitted with a Spherical Acute-Matte D viewfinder screen for extreme brightness, clarity and even illumination. An optional accessory screen with a grid pattern is also available.

To change a viewfinder screen, remove the viewfinder to access the viewfinder screen. To remove the screen, place the tip of a ballpoint pen or similar in the viewfinder screen removal lug and pull upwards. To replace the screen, position the right side of the screen in place so that it sits correctly in the recess. Place the tip of a ballpoint pen or similar in the viewfinder screen replacement indentation and press downwards until the screen snaps into position. Try to avoid touching either surface of the screen with bare fingers.

 Do not attempt to clean the screen by immersing it in water, or use any kind of cleaning fluid. If the screen becomes damp, do not use hot air to dry it. Use a soft cloth on the upper surface only. Seek advice from an Authorized Hasselblad Service Center if the screen becomes particularly soiled. Remember that particles or greasy marks on the screen might impair the viewfinder image but have no effect whatsoever on the recorded image.

16



17



Accessory connection

16, 17

On the left hand side of the camera body are two accessory retaining screw threads (M5), as well as a databus connector, protected beneath a cover. The connection has a dual-function, for service purposes and accessories such as the Global Image Locator.

The cover can be removed by inserting a pointed object, such as a pen, in the small hole and then sliding it to the left, as in the illustration. The retaining clip can then also be removed to access the connector.

PC-connector

A PC connector for non TTL-flash synchronisation is located on the left side of the body. It is protected by a captive rubber plug.

18



19

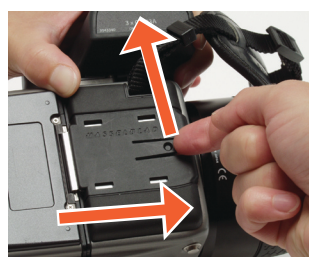

Protective base plate

18, 19

To attach the protective base plate, slip it over the camera foot until it stops. To remove it, lift the securing catch while pushing the plate back as in the illustration.

3

Viewfinder

- Multi-mode light metering
- Full exposure information
- 100% image
- 90° viewing angle for eye-line composition
- Full image for spectacle wearers
- Integral dioptre adjustment
- Integral flash unit

The 90° viewfinder provides a laterally corrected 100% image at eye-line level. It features a wide-range diopter adjustment to suit most users. The viewing distance is designed to provide full frame view even for eyeglass wearers. The bright Spherical Acute-Matte D focusing screens (located in the camera body) are interchangeable to suit preference, each of them naturally indicating the spot light metering area for accuracy in exposure estimation. The information display located beneath the viewing frame is continually updated and visible and is back lit for optimum visibility. This LCD also duplicates much information visible on the grip LCD for immediate checking. In addition to the LCD, there are four LEDs providing general warnings, flash and focus information.

The viewfinder also features a pop-up fill-flash unit for added convenience.

The viewfinder requires no batteries as it is supplied with power from the camera body and can be easily and quickly removed. Please see section on 'Flash' for full details.

See the 'Camera Body' section for details about the viewfinder screen.

The exposure compensation button and exposure mode button are described in the 'Function Control' section.

H2F

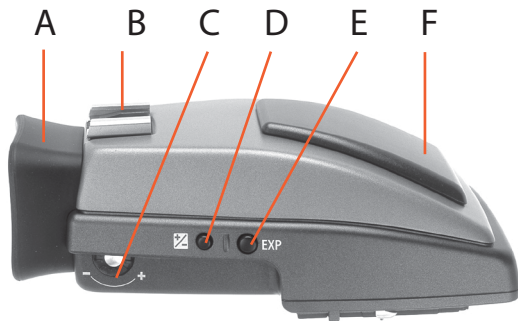

Parts & Components

- | | |
|---------------------------------|----------------------------------|
| A. Rubber eye cup | E. Exposure method / mode button |
| B. Hot shoe | F. Integral flash unit |
| C. Eyesight adjustment wheel | G. Flash unit button |
| D. Exposure compensation button | H. Viewfinder release button |

Attaching and removing the viewfinder



While holding the viewfinder at a slight angle and resting it on the top of the camera, slide the viewfinder forward until the front locating pin is in position in the recess in the front edge of the viewfinder screen aperture on camera body. Press the rear part of the viewfinder firmly downwards until it clicks into place.

Ensure that both sides of the viewfinder are seated correctly and that it has been firmly attached. Failure to do so could cause an intermittent malfunction if the databus interface connections between the viewfinder and camera body are not positively secured.

To remove, grasp the viewfinder in the right hand and while depressing the viewfinder release button, lift the rear of the viewfinder up and away from the camera body.

Eyepiece adjustment

No corrective lenses are needed to adjust the eyepiece to suit most requirements. The diopter range is from -4 D to +2.5 D. Eyeglass wearers can rapidly and accurately change the settings according to whether they wish to wear eyeglasses for viewing or not.

Personal eyepiece adjustments can be carried out by pointing the camera at the sky or similar smoothly toned area. While holding the camera in your left hand, you can with your right thumb turn the adjustment wheel until the markings on the viewfinder screen reach the optimum sharpness for your eyesight.

If you normally wear eyeglasses for distance viewing and intend to wear them for camera use then do not remove them for the above procedure. If, on the other hand, you prefer to remove your eyeglasses for camera work, then repeat the above procedure without wearing your eyeglasses.

Rubber eye cup

Two rubber eye cups are available for the H2F. The one supplied is suitable for users who do not intend to use eyeglasses when photographing. The second shorter eye cup is for those who either prefer to position their eye further from the viewfinder and those who wish to wear eyeglasses.

The eye cups can be rapidly changed by a Hasselblad Authorized Service Center.

Integral flash unit

See section on 'Flash' for full details.



Lenses

- Rapid and accurate automatic focusing capability
- Central electronic shutter
- Instant manual focus override with natural friction
- Instant automatic-focus return capability
- Non-rotation of filter or accessory when focusing
- Non-rotation of lens barrel in automatic focusing mode
- Shutter speeds 18 hours to 1/800 sec with film
- Reversed lens shade serves as protection
- Automatic detection of extension rings and converters

All HC lenses have been specially formulated for the H system to produce the extremely high performance expected from Hasselblad to meet the demands from conventional and digital photography alike. In addition to extreme sharpness, the design also incorporates a soft, pleasant looking boké (the visual quality of the out-of-focus areas of the image). All lenses feature an electronically controlled central shutter designed to extremely fine tolerances for supreme accuracy that also provides flash synchronization up to 1/800s. Speeds are from 18 hours to 1/800 sec. All lenses have a very rapid automatic focus capability with instant manual override. To ensure reliable and fast autofocus in low contrast and low light conditions, a focusing-assist light (on the grip) is automatically activated. Aperture and shutter control is set via the control wheels on the camera grip.

As a general rule, lens shades should always be fitted to achieve optimum performance. Protective filters (UV / Sky) should also be considered at least when working outdoors in harsh conditions.

(See Accessories section for information about the CF Adapter that allows the use of C type lenses from the Hasselblad V-system).



- A. Lens shade index
- B. Manual focus ring
- C. Focusing distance scales
- D. Depth-of-field scales
- E. Lens index

Attaching a lens

2, 3

Remove the front protective cover on the camera body by depressing the lens release button and keeping it depressed while turning the cover counter-clockwise. Remove the rear lens cap by unscrewing it in a counter-clockwise direction. Align the index on the lens with the index on the camera body and rotate the lens clockwise (bayonet fitting) until it clicks into place.

Removing a lens

Depress the lens release button and keep it depressed while rotating the lens counter-clockwise until it stops and lift it out. Replace protective caps on the lens immediately and on the camera body if necessary.

If you try to rotate the lens before you press the lens release button, it might lock. In this case, rotate the lens clockwise a little first and then re-attempt removal with the correct procedure: button first, then lens.

Front lens cap

4

Front lens caps are released for removal and attachment by inserting a thumb and index finger into the recesses and pinching in the direction of the arrows.

Filters

Filters have a screw thread fitting (67 / 77 / 95 mm, according to lens) and are screwed clockwise into place. As there is no rotation of the front section of the lens when focus is changed, filters do not rotate either. This is particularly useful when using polarizing or graduated filters where the orientation is normally critical.

Lens shades

5, 6

All lenses are supplied with lens shades that additionally provide extra protection for transport and storage when mounted in reverse. Lens shades have a bayonet fitting and are turned clockwise into place after ensuring the index on the lens shade aligns with the index on the front of the lens. When mounted in reverse, they are attached by matching the indexes and turning counter-clockwise.

Shutter and aperture control

Both the shutter and aperture are electronically controlled and are adjusted by the control wheels on the grip. There are no separate manual setting rings on the lenses or camera body.

The chosen settings are displayed both on the grip LCD and in the viewfinder LCD. See the 'Exposure Control' chapter for a complete explanation.



10

Lens focus setting too far beyond the distance of the subject framed by the central section in the viewfinder

11

Focus setting too close for the distance of the subject framed by the central section in the viewfinder

12

Focus setting correct

Depth-of-field calculation

7

There are two distance scales (in feet and metres) visible through the focus distance window on the upper part of the lens barrel. There is also a central lens index mark and a depth-of-field scale. The focusing distance is read off the chosen scale from the central lens index.

Depth-of-field can be calculated as follows:

1. Focus the lens as required.
2. Make an exposure reading (auto or manual) and note the aperture setting.
3. Find the markings on either side of the central index that correspond to the chosen aperture.
4. From these two markings, read off on the required lens distance scale the two corresponding distances.
5. The depth-of-field (at that particular aperture and focus setting) will be the area included between these two distances.

In the example given here, the focusing distance is set at nearly 3 metres. At an aperture of f/22, the depth-of-field would therefore extend from just over 2 m to approx. 4.5 m.

Stop down /depth-of-field

8

A visual depth-of-field preview can be made by depressing the **STOP DOWN** button while viewing the image on the viewfinder screen.

Infrared focus settings

9

As infrared rays form an image at a different plane to that formed by visible light, the normal focus settings do not apply. Proceed as follows in manual focus mode:

1. Focus the lens in the conventional manner until satisfied.
2. Note the distance setting against the central lens index.
3. Re-align this distance setting against the infrared mark (coloured red) instead of the central lens index.

Alternatively if you have already calculated the required distance, you can make a manual distance setting by using the distance scales together with the infrared mark instead of the central lens index.

Focus aid

As well as the conventional view on the focusing screen to ensure a sharp image, the H2F also features LED focus aid appearing as two arrowheads to the right of the viewfinder display (except for lenses with a maximum aperture of f/6.7 or smaller). The arrowheads provide confirmation of a precision focus setting and are a useful aid when making a setting with eyesight alone.

Manual focus setting

When the left arrowhead alone appears it means the focus setting is too far beyond the chosen distance (the area framed within the central zone in the viewfinder) and when the right arrowhead alone appears it means the focus setting is too close. Focus is correct when both arrowheads appear together. If the focus cannot be established, then both arrowheads flash.

Automatic focus setting

Focus is correct when both arrowheads are visible together. Focus is incorrect if only one arrowhead is visible. If the focus cannot be established, then both arrowheads flash.



CF Adapter

The CF adapter is an optional accessory that allows virtually all C type lenses from the V-system to be used on H-system camera bodies. This automatically expands the potential lens range for H cameras by more than a dozen different focal lengths. The automatic focusing system in the H camera can be used as a guide for manual focus setting. Light is measured at full aperture with all lenses which produces aperture and shutter speed information display in the camera for manual setting. With CFE lenses, however, a preset aperture is automatically transferred to the camera. Shutter cocking is manual with all lenses and is swiftly carried out by an easily accessible lever.

Specific-lens information

1 HC 3.5/300

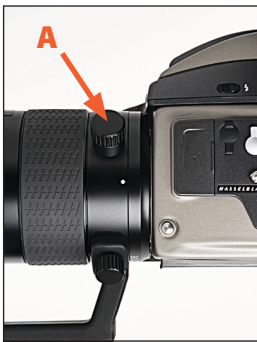

Landscape orientation

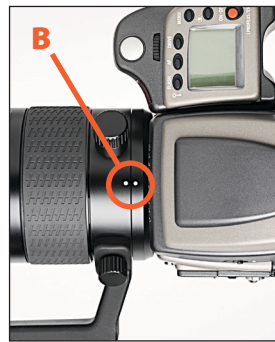

Portrait orientation

HC 3.5/300

1

When using a tripod with a 300mm you should use the (removable) tripod mounting bracket to provide optimum balance. This is attached via a sleeve so that the camera body can be rotated for landscape/portrait formats without altering the tripod head position. The rotation is secured by a locking screw (A). Correct 90° orientation can be ensured by aligning white index markers (B) for both landscape and portrait orientations.

2 HC 4/120 (Macro)

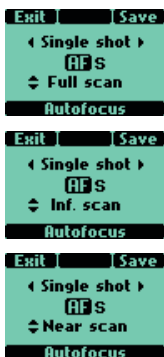

Full scan = 0.39 m – ∞

Inf. scan = 0.9 m – ∞

Near scan = 0.39 m – 1m

HC 4/120 (Macro)

2

In addition to the metres/feet scale, the 120 mm lens also displays magnification ratio scale (A). In the illustration, the scale shows a focusing distance of 1.27 feet / 0.39 metres which in turn produces a 1:1 (lifesize) magnification.

With the 120mm lens mounted on the camera, addition screens will appear on the grip LCD when autofocus is chosen to signify a focus limit setting. Three are available – Full scan, Infinity scan and Near scan – accessed by the rear control wheel. This time-saving function is a form of presetting that restricts the scanning range of the lens to prevent it searching across the whole focus scale. Simply make a rough assessment of the approximate focusing distance and then choose the most suitable of the three ranges. The lens will then be able to find the critical focus much faster.

HC 3.5–4.5/50–110 Zoom lens

Please read the advice that is included with this lens before use regarding how it should be placed or stored.

5

Film Magazines

- Automatic 120/220 compatibility
- Automatic wind on / wind off
- Automatic film advance
- LCD information panel
- Integral dark slide
- Customizable data imprinting
- Illuminated LCD
- Barcode recognition
- Count-up or count-down film frame reminder choice

The film magazine is a sophisticated semi-independent unit within the modular system. It has its own power supply for individual information storage, LCD panel, illumination, etc.

Much information is transmitted and received between the magazine and the camera body, so ensure the databus connection is kept clean and not damaged in any way. It is advisable to fit the magazine protective cover when storing a film magazine to protect both the databus connection and the darkslide.

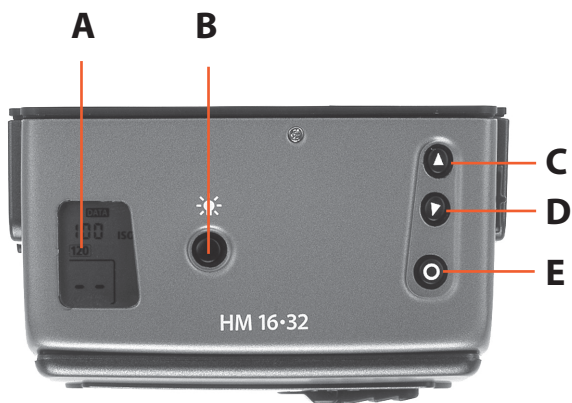

Parts and components

- | | |
|----------------------------|---------------------------|
| A. LCD panel | G. Darkslide key |
| B. LCD illumination button | H. Darkslide indicator |
| C. Change up button | I. Film tab holder |
| D. Change down button | J. Film holder key |
| E. Function selector | K. Magazine settings lock |
| F. Film plane index | L. Databus interface |

LCD panel

A

The various functions are accessed by repeatedly pressing the function selector button (loop menu) and changes made by the 'change-up' and 'change-down' buttons. Any settings are automatically saved. At very low temperatures the LCD will require a few seconds to display new settings.

LCD illumination button

B

The LCD can be illuminated by pressing the display illumination button, which is accessible when the magazine is not attached to the camera. The LCD will remain illuminated all the time you keep the button depressed, up to a maximum of 10 seconds. After 10 seconds has expired, you must release the pressure on the button and press again to obtain a further 10 second period of illumination. Remember that using the illumination function very often will noticeably shorten the life of the battery in the magazine.

When the magazine is attached to the camera, the button on the magazine is inaccessible but you can still illuminate the LCD by pressing the illumination button on the grip instead.

Change up button ▲

C

Can alter the settings 'upwards'. For example, to increase the film speed setting. Toggle action.

Change down button ▼

D

Can alter the settings 'downwards'. For example, to decrease the film speed setting. Toggle action.

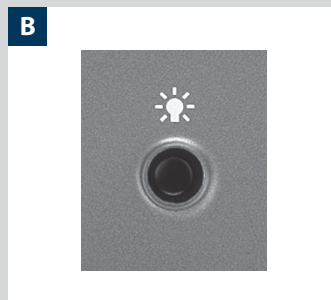
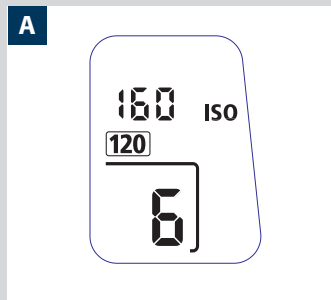

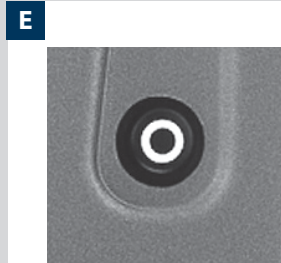

Function selector E

Selects the four functions that can be changed on the magazine. The functions are on a menu loop so that repeated pressing of the selector button will successively access all functions in turn. After a time-out of five seconds of non-activity, the display returns to the main screen.

Changes can only be made when the settings lock switch is in the unlocked position.

Film plane index F

Provides a measuring point for the actual position of the film plane in the magazine. Used for calculations in critical applications.

Darkslide indicator G

Indicates whether the darkslide is in place or withdrawn:

RED = stop! = exposure CANNOT be made (magazine can be removed from camera)

WHITE = ok! = exposure CAN be made (magazine cannot be removed from camera)

If you attempt to make an exposure when the darkslide is closed, however, you will receive a warning message in the viewfinder and grip LCDs – ‘The darkslide is closed’.

Darkslide key H

Withdraws and replaces the darkslide. Fold out the key and turn it counter-clockwise 360° (towards the open ⊞ symbol) to withdraw it and clockwise 360° (towards the closed ⊕ symbol) to replace it.

The darkslide can only be withdrawn when the magazine is attached to the camera.

Film tab holder I

Holds an ID tab from the film roll pack as a reminder of the type of film loaded. Don't forget to change it if you change film type!

Film holder key J

Secures the film holder in the magazine. Fold out the key and turn counter-clockwise 90° to remove the film holder and turn clockwise 90° to lock the film holder in place.

Magazine settings lock K

All settings can be locked to avoid inadvertent changes. To change the settings, slide the settings lock (see illus) to the right until it stops. After the changes have been made, slide the settings lock to the left (see symbol on magazine) again to secure the new settings.

Databus interface L

Data interface between magazine and camera. Ensure the contacts are kept clean and protected from damage. Keep the protective cover on when the magazine is being stored or transported.

Operation

Battery

The magazine uses a battery to retain information and settings when unattached from the camera. When attached to the camera body, the magazine takes its power requirements from the camera batteries. The magazine battery will normally be effective for 1-2 years depending on use (off camera illumination, for example).

When the battery is in a very low condition, (approx... 1 month of use left), a low-battery symbol appears on the magazine LCD as a warning.

The magazine will continue to function with no battery power left as long as it remains attached to the camera body. However, when detached, the settings will not be stored.

Battery replacement

1, 2

Release the film holder by folding out the film holder key and rotating it 90° in a counter-clockwise direction. Withdraw the film holder completely. On the bottom plate on the inside of the film magazine housing you will find a slotted circular battery cover. Insert a small coin or similar into the slot and rotate the cover about 20° in a counter-clockwise direction. The cover will be freed and the battery can be removed. Replace with a fresh CR2032 / 3V lithium (or equivalent) battery. Observe the polarity and ensure the positive (+) face is uppermost and replace the cover (ensure the retaining lugs are inserted in the battery compartment slots), locking it into place by rotating it in a clockwise direction until it stops. If you inadvertently insert the battery incorrectly, the film magazine will not be damaged though it will not function. Try to avoid touching the surface of the battery with your bare fingers as sweat residue can decrease the electrical conductivity of the battery casing and might cause corrosion.

After battery replacement, the magazine's parameters return to the default settings (Barcode, 120, Data-on, Count up).

Attaching and removing the magazine

3, 4

You cannot remove a magazine from the camera body if the magazine darkslide is not in place, (when the magazine darkslide indicator on the magazine shows white). Neither can you withdraw the magazine darkslide when the magazine is not attached to the camera. Both these restrictions therefore prevent accidental film loss caused by fogging.



Attachment

Position the magazine retention groove onto the magazine support on the camera body ensuring that they are correctly positioned. Swing the magazine towards the camera body and firmly press into place with a click. If there is resistance, the magazine retaining catch on the camera has probably been inadvertently released. In that case, push the release button again to reset the catch.

You can attach and remove the magazine with or without the film holder in place. If you just want to change to a new film, you can remove and reload the film holder without having to remove the whole magazine.

Removal

Ensure that the darkslide indicator on the magazine shows red (signifying that the darkslide is closed). Firstly push the lever of the magazine release button to the right (illus 1) and while maintaining that position press the centre of the button firmly inwards towards the camera body (illus 2) to finally release the magazine.

-  Ensure you press on the centre of the button, not on the lever.
-  You cannot remove a magazine if the darkslide is not closed.
-  If the film holder is inadvertently removed mid-film, then exposed frames will naturally be lost due to light fogging. However, if the film holder is quickly re-inserted, the film will automatically be advanced by three frames to position fresh unexposed film. The film counter will also correspondingly add on three frames to the original number recorded before the film holder was removed.

1

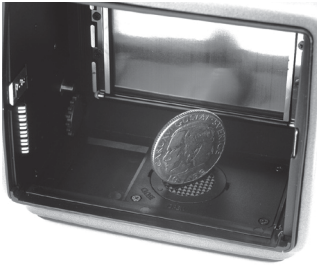

2



3



4



Magazine settings

Press the function selector ( button) repeatedly to successively access:

- Film speed (ISO / Bar Code)
- Film length (120/220/ Number of frames)
- Data (on/off)
- Frame counter (count down / count up)
- Low-battery warning symbol



Film speed setting / Barcode

The film speed (ISO / ASA) can be set automatically or manually. Automatic setting uses a Barcode (only some films have this feature). This is the default setting.

 Film settings (ISO / film length) are automatic only if the magazine is set at Barcode automatic. That is, a barcoded film cannot override a manual film speed setting but a manual setting can override the film speed of a barcoded film.

 Films without a barcode must have their speed set manually. A manual setting must also be made if you want to override the speed setting of a barcoded film.

To access Manual setting:

- Ensure the magazine settings lock is in the unlocked position.
- Press the  button until a figure (or barcode symbol) appears together with ISO.
- Press either the  or the  button to reach the required setting.
- The new setting will be saved automatically after a time out of five seconds.
- Return the LCD settings lock to the locked position.

 If you use both standard and barcoded films (or overridden barcoded films), check that you have changed the settings accordingly.



Film length/number of frames

Both 120 and 220 films can be used. 120 film will produce 8 (for use with 'half-length' 120 films only) or 16 frames and 220 film will produce 32 frames.

If the film has a barcode, then film length setting (and film speed setting) is automatic. The LCD will automatically show the barcode symbol and the appropriate film length. (Note that film speed can be overridden with barcoded films, but not film length).

If, however, the film has no barcode then proceed as follows:

To access film type setting:

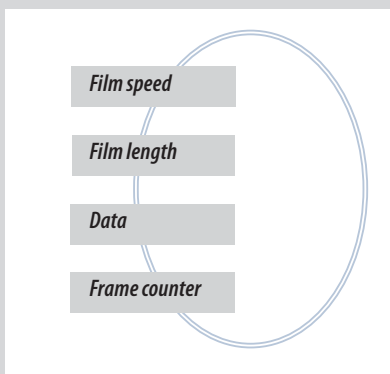
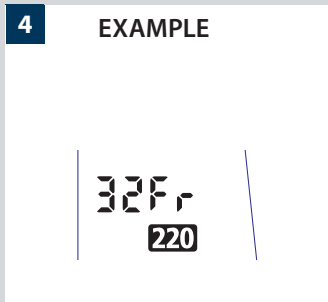
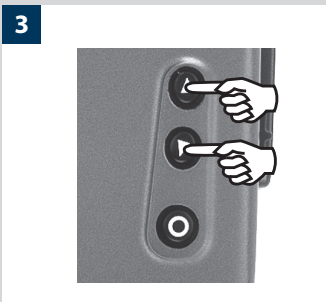
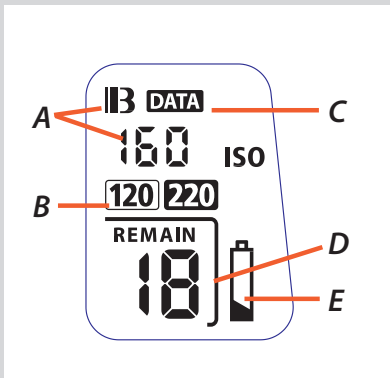

- Ensure the magazine settings lock is in the unlocked position.
- Press the  button until the 120 or 220 symbol appears.
- Press either the  or the  button to change the desired setting.
- The new setting will be saved automatically after timeout.
- Return the magazine settings lock to the locked position.



Data imprint setting

Data imprinting can be activated or deactivated through the magazine menu.

To access data setting:



- 1) Ensure the magazine settings lock is in the unlocked position.
- 2) Press the  button until the Data symbol appears.
- 3) Press either the  or the  button to reach On or Off.
- 4) The new setting will be saved automatically after a time out of five seconds.
- 5) Return the magazine settings lock to the locked position.

 Operation and changes made to the data imprinting function are accessed through the camera menu. Please see separate section for full details.

Frame counter setting

The frame counter can be set to show either how many unexposed frames remain on a film or how many frames have already been exposed. The LCD shows your choice of setting by adding the word Remain as a reminder of the number of frames *remaining* or 'countdown'. Absence of this word implies the opposite, namely, 'count-up', so it denotes the number of the next frame to be used (for example, the figure 4 means three frames have already been exposed). This information is also automatically displayed on the grip LCD and viewfinder LCD though only as a figure above a symbol.

To access frame counter setting:

- 1) Ensure the magazine settings lock is in the unlocked position.
- 2) Press the  button until Remain appears.
- 3) Press either the  button or the  button to reach the desired setting (toggle function).
'on' will show the number of frames remaining
'off' will show the number of the next frame.
- 4) The new setting will be saved automatically after a time out of five seconds.
- 5) Return the magazine settings lock to the locked position.

Low-battery symbol

The low-battery symbol only appears on the magazine LCD when the battery needs changing.

Example

In the example shown here:

- 120 film length set manually
- the film speed (ISO160) has been set manually
- 5 frames have already been exposed (therefore with regular 120 film, 11 frames remain)
- the battery is functional



Manual film speed setting.



220 film length setting.



Data imprinting setting.



'Frames remaining' counter setting.

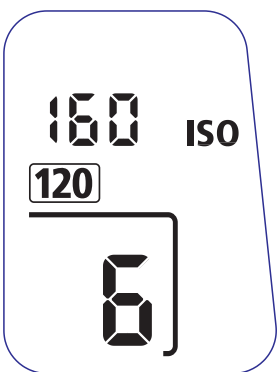
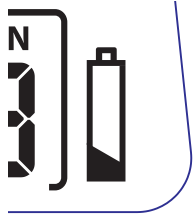

Film loading

The film magazine can be loaded either on or off the camera. Regularly check the interior of the magazine and remove dust, particles or any scraps of paper from previous rolls of film. Load and unload film magazines away from direct light sources.

- 1) Fold out the film holder key and turn it counter-clockwise 90°. Withdraw the film holder completely.
- 2) Place an empty take-up spool in the upper spool holder by placing one end over the fixed stud in the holder and the other end underneath the sprung spool retaining arm. Rotate the spool a little if necessary until it clicks into position.
- 3) Completely remove the retaining paper band from a new roll of film and place it in the lower spool holder. See diagram for correct orientation. Ensure you do not place the film spool the wrong way around!
- 4) Pull 8–10 cm (3–4 in.) of paper backing from the film roll and insert the tongue of the backing paper into the slot in the take-up spool. Turn the spool one complete turn to ensure the tongue is firmly held in place by the overlying paper backing.
- 5) Re-insert the film holder into the main body of the film magazine ensuring the correct orientation. Press firmly inwards towards the magazine and pay particular attention to see that both sides are level with the magazine body before turning the film holder key clockwise 90° to lock the film holder in place and fold the key back into its stored position. You might find that increased pressure on the left hand side of the film holder will more easily ensure a positive and correct positioning in the magazine.
If the camera is active or in standby mode the film will be wound automatically by the camera to position the first frame by a half-press of the release button (this default function can be changed in 'Custom options' so that the film is advanced directly).

Beeper

The beeper sounds immediately after the last-but-one frame has been exposed. This function can be turned off in Custom Options.

Film wind off

When the last frame has been exposed, the film will automatically be wound off. However, to wind off a film sooner, press the film wind off button (on the camera). Use a ballpoint pen or similar to activate it. You must also confirm the message on the grip LCD before the film rewinds.

Unloading a film

To remove a film, remove the film holder in the same manner as when loading a film. Grip the exposed roll of film firmly and remove. Ensure the paper backing is wound tightly and that it is sealed with the band properly (the band may need to be moistened to activate the adhesive depending on type). Store exposed films away from strong light sources and contact with sharp objects. Move the remaining empty spool to the take-up spool compartment.

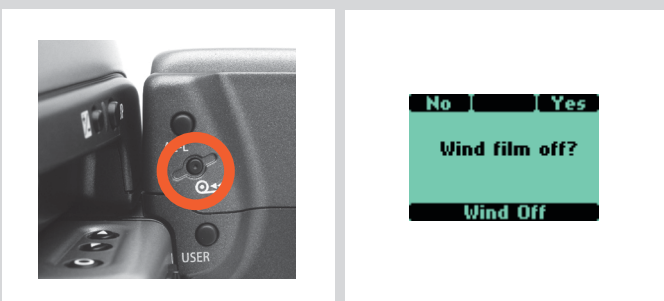

6

Digital Photography

- Excellent compatibility with Hasselblad digital backs
- Information visible on camera LCD
- Tethered and untethered solutions for maximum flexibility

H system cameras were designed with digital photography in mind right from the outset so a digital back is not just an extremely useful accessory but is rather an integral part of the initial H system modular concept. This paves the way for seamless integration and consequently increased efficiency and improved workflow.

All HC/HCD lenses were also formulated to meet the very high demands made by digital sensors, which they do with ease.

H2F



Hasselblad provides a number of digital solutions that can also be used with large format cameras, thereby creating the most comprehensive range for digital high end photography.

The H2F offers a versatile platform for both analogue and digital work. However, digital integration is a fundament of the H system concept resulting in much more efficiency.

The H2F grip LCD is pixel-based to take advantage of interpreting signals from a digital back, resulting in a digital display on the camera and not just on the back or host computer screen. A histogram can be displayed on the grip for immediate checking, for example. A histogram thus displayed consumes less battery power than if it is displayed on the digital back.

Additionally, the H2F can be custom set to accommodate digital requirements. The User button, for example, can be set to immediately access grey balance adjustment on the digital back.

CF / CFH

The CF digital backs, 22 and 39 Mpix, are custom built to fit the design and functionality of the Hasselblad H2F camera with its range of high performance, leaf shutter based lenses. The CFH also fits onto view cameras using the H-system interface plate for mechanical attachment and flash sync connection to trigger the digital capture. In this way, the CFH offers an ultra high level of integration and flexibility to the specialist professional photographer.

The CFH is the first digital back which integrates completely to the new power system of the Hasselblad H2F camera. This means that both the camera and the digital back use the one Li-ion battery of the H2F as their power source.

The H2F also recognizes Hasselblad's Instant Approval Architecture, bringing automated image classification into your digital workflow from the split second of capture with the CFH back.

The CFH offers the following features:

Unique Hasselblad Natural Color Solution

In the past, color management solutions have imposed limitations on professional digital photographers, because of the need to choose a specific color profile to suit a specific job in order to capture various skin tones, metals, fabrics, flowers, etc. Hasselblad has helped solve this dilemma, with the development of a single powerful color profile to be used with its FlexColor and Phocus imaging software. Working with the new Hasselblad Natural Color Solution (HNCS) enables you to produce outstanding and reliable out-of-the-box colors, with skin tones, specific product colors and other difficult tones reproduced easily and effectively.



In order to incorporate the new unique HNCS and DAC features we have developed a custom Hasselblad raw file format called 3FR. It is designed to ensure that images captured on Hasselblad digital products are quickly, effectively and safely stored on the available media. This file format includes lossless image compression, which reduces the required storage space by 33%. The 3FR file defines the colors in the Hasselblad RGB color space with its out-of-the-box quality, and used in conjunction with FlexColor or Phocus, it removes both the need for experimenting with different color profiles to obtain optimal colors and the need for selective color corrections.

DNG workflow

3FR files can also be converted into Adobe's raw image format DNG ('Digital Negative'), bringing this new technology standard to the professional photographer for the first time. In order to utilize DAC and optimize the colors of the DNG file format, conversion from 3FR must take place through FlexColor or Phocus. The DNG file format enables raw, compressed image files to be opened directly in Adobe PhotoShop. Hasselblad image files carry a full set of metadata, including capture conditions, keywords and copyright, facilitating work with image asset management solutions.

Instant Approval Architecture

Limitless digital image capture loses some of its potential if the photographer cannot quickly review and select the best images to present to the client. Building on the success of its Audio Exposure Feedback technology, Hasselblad has created Instant Approval Architecture (IAA), an enhanced set of feedback tools, designed to liberate the photographer to focus on the shoot rather than the selection process. IAA triggers audible and visual signals for each image captured, notifying the photographer immediately of its classification status. The information is recorded both in the file and in the file name, providing a quick and easy way to classify and select images, in the field or in the lab. The Hasselblad CFH is fully integrated with the Hasselblad Instant Approval Architecture, bringing automated image classification into your digital workflow from the split second of capture. IAA is a Hasselblad trademark and Hasselblad has a patent pending on the invention. Large enhanced OLED displays on the new Hasselblad products provide a realistic, high quality and perfect contrast image view, even in bright sunlight, to allow instant on-site image approval.

Three modes of operation and storage

Optimum portability and image storage are critical for the professional photographer. The Hasselblad CFH offers a choice of storage devices: portable CF cards, the flexible ImageBank -II or a computer hard drive. With these three operating and storage options, you are able to select a mode to suit the nature of the work in hand, whether in the studio or on location.

"Instant" user interface

The Hasselblad CFH is operated via an easy-to-use user interface, utilizing a series of "instant" one-button-click operations including instant capture, instant browse, instant approval, instant zoom, and instant image info.

FlexColor and Phocus workflow

FlexColor and Phocus offer an image processing workflow with the highest degree of control for the studio as well as location photographer. There is a selection of tools that speeds up professional level workflow. FlexColor runs natively on both Macintosh and Windows computers and both applications are licensed to allow you to provide free copies for all your co-workers and production partners.

Please see the Hasselblad website – www.hasselblad.com – for the latest updates on CFH backs complete with full explanations of IAA, DNG, HNCS, DAC and all the other features that make it the obvious choice for the H2F.

Light Metering & Exposure Control

- Three metering methods
- Five exposure methods
- Extremely accurate light metering

The light metering system of the HV90X viewfinder is capable of selective sensitivity producing three reflective metering methods: Average, Centre weighted and Spot. All methods are measured in increments of 1/12 EV. Information transfer is rapid and automatic ensuring consistently correct exposure settings even in difficult and changeable lighting situations.

Light measurement is made through the lens (TTL) by the AE viewfinder and exposure is controlled manually or automatically by the control wheels and/or settings. The information is visible on both the grip LCD and the viewfinder LCD.

A great deal of control is available ranging from 100% manual through to sophisticated fully automatic by way of the various exposure methods: Manual, Aperture priority, Shutter priority, Program and Program variable.

Light metering and exposure control

Two primary factors have to be considered when making exposure control choice, namely, metering method and exposure method:

Metering method determines in which manner the light measurement is made and how much of the image is taken into account (Average, Centre Weighted and Spot).

Exposure method involves the parameters and deciding factors about how the light measurement is translated into aperture and shutter speeds. Here the choice is about the camera controls and their effect on the result or suitability for the subject. Included in this choice is the type of automation too (Manual for 100% user control, Aperture priority, Program, etc for automated control).

Some methods and modes are much more suited to various situations and applications than others, while some depend to a greater degree on personal preference and ways of working. A discussion of the points to consider in this context is beyond the scope of this manual. If you are not sure about choice, please check in other general photographic literature for a fuller explanation. Also check our website occasionally – www.hasselblad.com – for articles and discussions concerning such matters.



Remember that exposure configurations are only applicable to the speed of the film in use. Ensure you have the correct setting on the film magazine!

Since the light measuring system is TTL, filter factors, lens extension / extension ring factors, etc, are automatically taken into account for average purposes. However, some combinations of methods and equipment can cause slight discrepancies for various reasons and therefore for critical work you should make alternative exposures to suit personal preference.

 Exposures are displayed on the grip LCD to within 1, 1/2 and 1/3 EV tolerances (dependent on setting). This means that 'half-stops' are shown in a form that can differ from more traditional displays. For example, the position between f/8 and f/11 is displayed as f9.5 and likewise the position between 1/30s and 1/60s is displayed as 45. Therefore a display showing 'f9.5 45' simply means 'f/9.5 at 1/45 second'. The appearance of an 's' after the shutter speed signifies whole seconds so, for example, '45s' on the display signifies an exposure time of 45 seconds, not 1/45.

Metering method

There are three metering methods available. All three are reflective methods (measuring the light reflected off various selected parts of the subject according to method) and are through the lens (TTL). These have the following designations (with their respective LCD symbols):

-  — Average
-  — Centre weighted
-  — Spot

Average: Commonly used for 'average' light situations where there is no particular dominance of light or dark areas across the tonal range. Takes into account approximately 70% of the image seen in the viewfinder.

Centre weighted: Emphasises the central section of the focusing screen equivalent to approximately 20% of the image. This provides a balanced assessment and is a typical choice where the main subject is in the centre of the image.

Spot: The sensitive area is equivalent to approximately 2% of the image area (the central spot on the viewfinder screen). Any parts of the image outside of this area will not affect the exposure reading. This provides a very accurate measurement of specific tones. Typically used in the zone system and similar light measuring situations where maximum control is required. Also excellent for tonal comparison measurements. The spot mode can display 'zones' instead of EVs in the viewfinder LCD (see Camera Options).

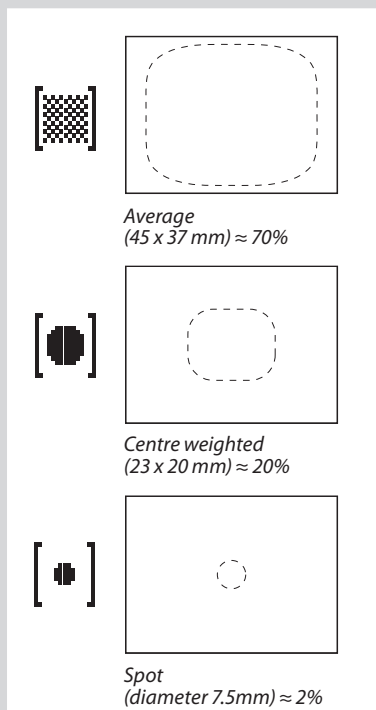

Selecting metering method

Proceed as follows with the camera in active mode:

1. Press the **EXP** button on the viewfinder.
2. Turn the rear control wheel (in either direction 2a) to successively access the three choices: **Average**, **Centre Weighted**, and **Spot** 2b.
3. Press **Save** (**DRIVE** button) to retain the setting.

Exposure method

Exposure can be controlled either manually or by using one of four automatic modes. These have the following designations on the grip LCD:

M – Manual

A – Aperture (priority)

S – Shutter (priority)

P – Program

Pv – Program variable

In each mode you can see both the aperture and the shutter speed information on the grip LCD and on the viewfinder LCD.

In manual mode, aperture is set by the front control wheel and the shutter speed by the rear control wheel.

In the automatic modes, the aperture and shutter speed settings are controlled by the camera, either partially or completely according to setting. Within this mode there are four choices.

(Please see the Appendix for P and Pv mode charts that describe the aperture and shutter speed setting combinations).

MANUAL EXPOSURE — M

Manual mode will provide total user control of the shutter and aperture settings.

To set the Manual mode, proceed as follows with the camera in active mode:

- 1) Press the **EXP** button on the viewfinder.
- 2) Turn the front control wheel (either direction 2a) until you reach **M** (Manual) 2b.
- 3) Press **Save** (**DRIVE** button) to retain the setting.

In this mode the shutter speed and aperture settings are manually chosen by turning the front and rear control wheels.

The standard exposure setting is obtained when the pointer over the exposure scale is positioned above the central index (in the viewfinder LCD).

Any deviation from this standard setting is displayed by:

- the pointer appearing elsewhere than above the central index and
- by figures above the scale representing the amount of adjustment in EVs.

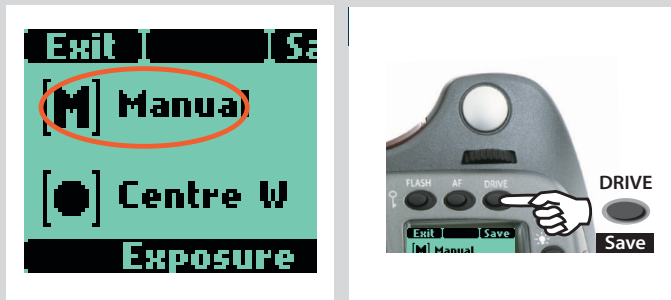
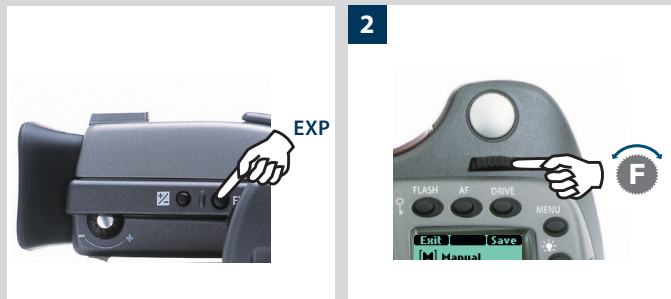
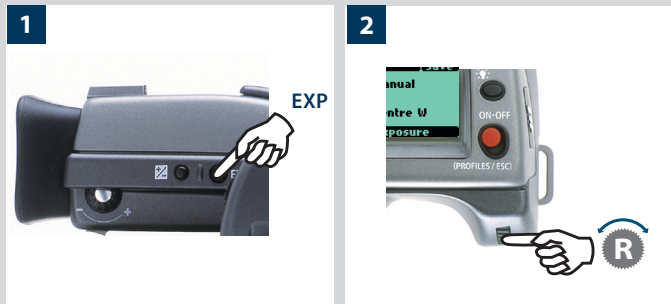

4

+0.7 ± f5.6 30

1



2



3

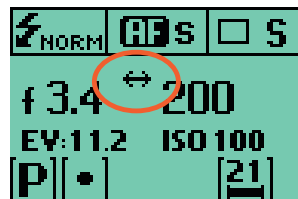
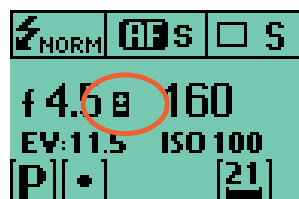

A '+ 0.7' above the scale in the display, as in illustration 4 for example, would indicate a '0.3 EV overexposure' setting. Conversely, a '-2', for example, would indicate a '2EV underexposure' setting. Note that the appearance of a +/- symbol on the grip and viewfinder LCDs in manual mode means that a change has been made to the exposure compensation setting. See later section on 'Exposure compensation'.

The actual aperture settings and shutter speeds are indicated to the right of the exposure scale in the conventional manner. (Note: 'full-stops', 'half-stops' and 'third-stops' are also displayed, according to setting (see 'increment setting'). For example, a setting between f/8 and f/11 will appear as f/9,5 if 'half-stop' is chosen).

The B shutter speed position is active and therefore consumes battery power.

The T shutter speed position, however, is equivalent to the standby mode regarding battery consumption. For exposures longer than five minutes, use the long exposure setting instead that automatically activates the standby mode after 4 minutes.

AUTOMATIC EXPOSURE — A, S, P, Pv

Automatic exposure provides a choice of two ways of controlling shutter speed and aperture settings semi-automatically and two ways fully automatically:

Aperture priority: A - The aperture is manually chosen by you by turning the front control wheel, and the shutter speed is automatically chosen by the camera.

Shutter priority: S - The shutter speed is manually chosen by you by turning the front control wheel, and the aperture is automatically chosen by the camera.

Programmed: P - In this mode, an aperture / shutter combination is chosen by the camera according to the EV measured (metering method remains as your choice), though only within pre-set appropriate limitations to suit various requirements and applications.

Programmed variable: Pv - This mode is very similar to Programmed, except with the additional parameters of lens focal length being automatically taken into account. For example, long shutter speeds will automatically be avoided with a long focal length lens.

To set one of the modes, proceed as follows with the camera in active mode:

- 1) Press the **EXP** button on the viewfinder.
- 2) Turn the front control wheel (either direction) until you reach the required setting.
- 3) Press **Save (DRIVE button)** to retain the setting.

In Automatic mode the front control wheel selects alternative combinations while maintaining the same EV and the rear control wheel alters the amount of exposure compensation. The compensation appears as +/- symbol on the grip LCD and viewfinder LCD. Other combinations that are outside the parameters offered by the Pv mode (but nevertheless still provide correct exposure) are signified by a double arrow symbol appearing between the aperture and speed settings on the grip LCD.

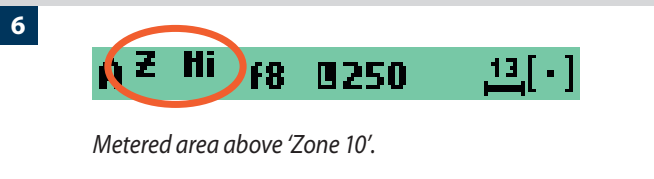
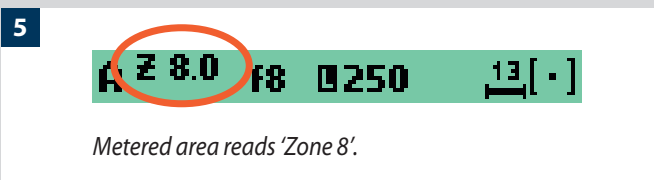
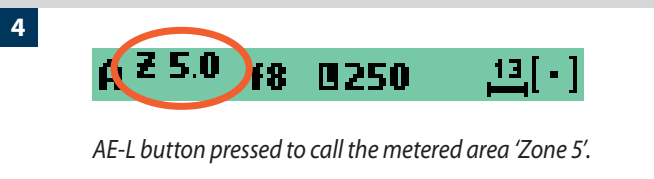
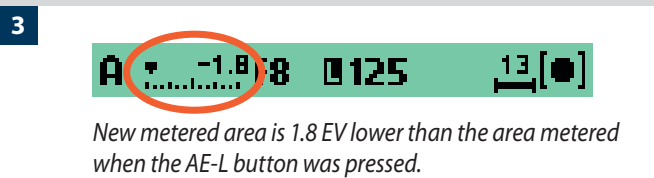
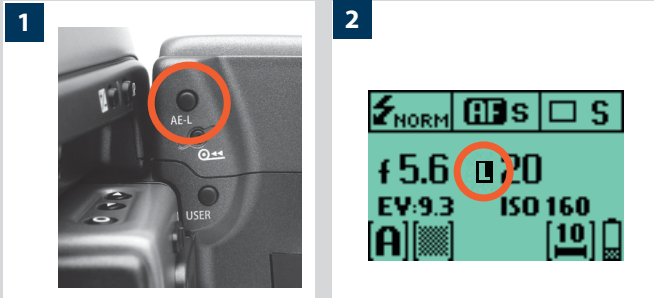

This button has two main functions that can be incorporated in various working methods involving exposure locking. It also has an extra function for the flash meter capability (see AE-L section under Flash). The **AE-L** button can:

- lock an EV setting in manual and automatic modes.
- be used as a brightness range checking facility in standard terminology or Zone System terminology.

a) When the button is pressed (fig 1), the light metering facility is locked to the EV setting at that moment. An **L** (= locked) symbol appears between the shutter speed and the aperture indication (fig 2) on the grip LCD and viewfinder LCD to confirm the status. Press the **AE-L** button again to unlock (toggle function).

In the locked setting, the aperture and shutter speed become interlocked. In this way, a new aperture/shutter combination that still represents the same EV, can be rapidly chosen. For example, if you set the shutter at 1/125s and the aperture at f/8 and lock them together, you can access new EV-equivalent combinations of, for example, 1/30s at a f/16 or 1/500s at f/4 just by moving the front control wheel.

In practice this means you could, for example, in auto mode, position the metering area (spot setting) over an area in the subject that you determine to be equivalent to a mid-grey and lock it with the **AE-L** button. You can then recompose the picture with the metering zone positioned over an area much brighter or darker while still retaining the original exposure setting and choose a new combination of aperture and shutter speed settings.

b) The **AE-L** button also allows the spot metering function to make tonal comparison readings and brightness range checks. When the **AE-L** button is pressed, the metered area is saved as a mid-grey. When the spot area is then placed over another part of the scene, the new area is then compared to the saved area and the difference can be read off the scale seen in the viewfinder. For example, in a landscape situation you could meter the foreground, lock the reading with the **AE-L** button (thereby locking that area to be reproduced as the equivalent to a mid-grey 18%), point the camera at some rocks to see by how much darker they are compared to the foreground by the EV difference read off the scale (illus 3).

If you have chosen **Spot** together with **Zone** display (see Custom options) as well as one of the automatic modes **A**, **S**, **P** or **Pv**, point the spot marking at an area that you decide should be a Zone 5 and click the **AE-L** button (illus 4). The meter will now display different parts of the subject as zone values (illus 5) in the viewfinder LCD, instead of EV deviations, as you move the spot marking over the subject. (Included are **Lo** and **Hi** (illus 6) to signify areas beyond the range of the film).

Alternatively you can choose to re-classify an area as another zone and then check the rest of the subject to see how other areas fall on the zone scale. Do this by following the above procedure and then turning the rear control wheel until you see the new desired zone value in the viewfinder LCD. You will also see the new exposure that will now produce that new zone. For example, you might have measured a rock at zone 5 but wish to make it darker. By moving the rear control wheel you could re-classify it as zone 4. You will then be able to see, for example, whether white clouds are now falling within the exposure range by their new Zone classification.

Alternatively, you can also pre-set the initial zone reading in order to save time and effort where there is no freely available 'zone 5' subject for light measuring. For example, you might be on a sandy beach where you know that sand is normally classified as zone 6. You can pre-programme the zone placement by holding down the **AE-L** button while choosing the new zone value and turning the front control wheel until zone 6 appears. Pointing the camera at other parts of the scene will now display their zone values (in relation to the initial setting of sand at zone 6) to see whether they still lie within the range of the film and how they might appear in the result (apart from film development considerations). See under Zone in the Appendix for further information about the zone system.

Exposure compensation

The exposure compensation facility, for both manual and automatic modes can be set from -5 to +5 EV, in 1/3 EV increments. This facility will adjust the exposures by the set amount until changed and the setting is visible above the scale in the viewfinder and as a \pm symbol on the grip LCD.

To make a fixed exposure compensation setting, proceed as follows with the camera in active mode:

- 1) Press the +/- button on the viewfinder.
- 2) Turn either the front or rear control wheels to increase or decrease the amount of compensation in 1/3 EV steps.
- 3) The amount is displayed in the viewfinder as both an EV figure complete with a 'minus' or 'plus' prefix (A in illustration), and as a marker above a 'minus' to 'plus' scale with a central index signifying zero compensation (B in illustration).
- 4) Press **Save (DRIVE)** button to retain the setting.
- 5) A \pm symbol is then displayed between the aperture and shutter speed setting as confirmation of the setting.

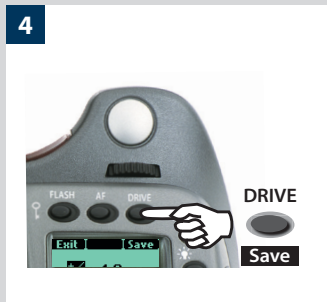
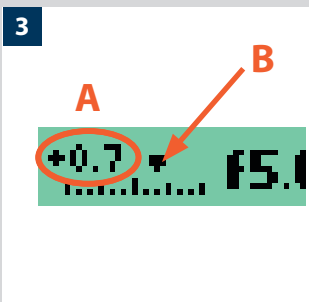
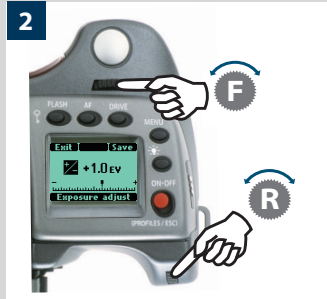

8

General Functions

- Manual and autofocus modes
- Three drive modes
- Quick adjust wheel
- Profiles

This section describes the basic and general functions used in most situations.

By understanding the capabilities of the H system you will be able to gain a great deal of control of how you work in the future. By taking advantage of the many features available, you might well find your normal practices changing for the better. As all features are user controllable, you tailor the way the camera works according to your preferences.

Features such as the Quick adjust wheel and Profiles, for example, do not have to be used of course, but you are advised to read about them and see if they might suit your way of working.



Power

The camera can be set at two active power modes – **ON** or **Standby** – as well as **OFF**. In active modes, battery consumption is least in **Standby** mode and most in **ON** mode. The camera enters **Standby** mode automatically after 10 seconds (default) to preserve battery consumption but this interval can be changed in Custom Options. Also, after 10 seconds, the display on the OLED on the sensor unit is dimmed and after 30 seconds the display is turned off completely. After 3 minutes the sensor unit enters the Standby mode. Settings can only be made when the camera is in the **ON** mode (the sensor unit has its own Standby setting).

ON

To activate the camera press the red **ON.OFF** button until you see the start-up H2F logo appear on the grip LCD. The logo is automatically followed by the main screen. The camera is now in **ON** mode.

After a set period of inactivity (programmable in Custom Options) the camera automatically enters Standby mode, signalled by the appearance of the H2F logo again.

Standby

In this mode the camera is in a mainly inactive ‘standby’ mode and is ready to be immediately reactivated to the **ON** mode by:

- pressing the shutter release button half way
- clicking the **ON.OFF** button
- pressing the **Stop down, Mirror up, User** or **AE-L** button

In this mode, signalled by the standby H2F logo appearing on the grip LCD, the demand on the batteries is very low. It is ideal for general use where intervals between shots exceed a few seconds.

Standby mode is automatically set from the **ON** mode after 10 seconds (default) of inactive use (programmable in Custom Options).

OFF

From the active screen, press (not click !) the red **ON.OFF** button for a half second. All buttons (except the **ON.OFF** button) remain ineffective, producing minimal demand on the batteries. This is the normal mode when transporting or storing the camera or where there might be a risk of inadvertently activating the camera. (However, remove the batteries if you are going to store the camera for a period of more than a few weeks).

In this mode neither the viewfinder LCD nor grip LCD information is available. The magazine LCD, however, will continue to display information as it is independently powered. **OFF** mode is automatically set after six hours of inactivity in **Standby** mode.

Manual focus

There is both a **Manual Focus** mode setting and a **Manual Override** capability. **Manual Focus** is a specific setting that you actively make, whereas **Manual Override** is always available as a temporary override of an autofocus setting.

In **Manual Focus** mode, focusing is carried out by rotating the focusing ring in the conventional manner. The focus setting remains until changed as with a conventional non-autofocus lens. This means that pressing the shutter release button will not activate a focus setting change as it does in autofocus. To change back to autofocus, you must make a new setting (by pressing the **AF** button and choosing **AF S** or **AF C**).

With **Manual Override**, you can manually alter a focus setting that has been made in the autofocus mode, by rotating the lens barrel in the conventional manner and without having to change modes. As long as the shutter release button is kept at the half-press position, the new focus setting is maintained. By releasing the pressure on the shutter release button and pressing again, the autofocus function is immediately reactivated.

1



2



3

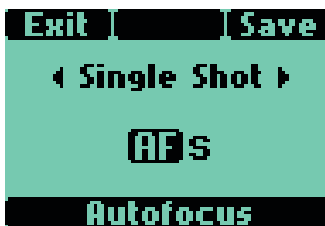

Manual focus mode

The **Manual focus mode** is set by the front control wheel on the grip in the following manner:

In camera active mode:

- 1) Press the **AF** button on the grip.
- 2) Turn the front control wheel to: **Manual**
- 3) Press **Save** to store the setting.

 You can also use the shutter release button 'half-press' function to save a new setting and automatically return to the main screen.

Natural friction is inherent in the design to purposely reproduce the secure feel of a completely manual lens.

Please note that when focusing manually, the infinity and closest distance marks on the lens scale can appear to be positioned beyond the central index. This is only an apparent effect and does not change the focusing range of the lens.

Autofocus override in Manual mode

See Autofocus section for a description of how to use the advantages of a rapid autofocus check while remaining in Manual mode.

Autofocus

Autofocus mode can be either **Single Shot** or **Continuous** and is activated by pressing the shutter release to the half-press position. Its operative range from EV1 - 19 at ISO100. The point of focus is determined by the area within the central rectangular zone on the focusing screen. When light levels are too low or the contrast of the subject is too low, auxiliary illumination (situated on the top of the grip) is automatically activated if desired. The operative distance is approximately six metres from the camera. Alternatively, a suitable attached flash unit that has a similar facility (a Metz 54/70, for example) can also be used instead. This feature can be altered in settings; see under Custom options/AF assist light.

 The autofocus range on the HC 4/120 Macro lens can be limited by a specific setting on the camera allowing for near range, far range or full range. This only appears on the grip LCD together with this particular lens.

Single Shot

In **Single Shot** setting (**AF S**), the shutter release will be blocked until the camera finds the optimum focus setting. This ensures that no exposures can be made that are not finely focused. However, this delay will normally be only a fraction of a second in good lighting conditions with a clear focusing pattern.

Note though that in this mode the lens will focus at a distance and will remain focused at that distance while pressure remains on the shutter release button. In this way, you can focus on a nearby object for example, temporarily positioned within the focusing zone on the viewing screen and then without releasing pressure on the shutter release button, recompose knowing that the focus remains on the object chosen even though it is now outside the focusing zone. Releasing the pressure on the shutter release button and pressing again half way would now change the focus setting to the distance of the object within the focusing zone.

See under 'Manual override in autofocus mode' for a useful way of working with manual and autofocus settings in a combined manner.

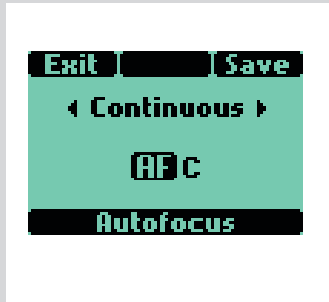

Continuous

At Continuous setting (**AF C**), the shutter can be released rapidly before the lens is focused in order to capture a split-second shot (in **Single Shot**, an exposure cannot be made until the camera has had time to focus). However, the camera will continue to focus if a moving subject is within the focusing zone or if you recompose, even though the shutter release button is half pressed.

One method to exploit this feature when photographing in a rapidly changing situation such as photojournalism, for example, is to keep the shutter release button pressed down. In this way the lens focuses constantly (according to the focusing zone) and by momentarily releasing the pressure on the shutter release and then immediately pressing again, you minimize the amount of time needed for the lens to check focus, thus ensuring a split-second shot at optimum focus.

Autofocus mode

Autofocus is set via the control wheels in the following manner:

In camera active mode:

- 1) Press the **AF** button on the grip.
- 2) Turn the front control wheel to: **Single Shot** or **Continuous** as required.
- 3) Press **Save** (**DRIVE** button) to store the setting.

Manual override in autofocus mode

Manual override is always possible in automatic focus mode without any need to make a new setting; just rotate the focusing ring in the conventional manner. As the lens barrel does not rotate in autofocus mode, you can hold the focusing ring for instant manual adjustments as you would with a conventional lens. However, to retain the new manual focus adjustments, you must maintain the pressure on the shutter release button. You can instantly return to the automatic focusing mode by releasing the pressure on the shutter release button first and then pressing the release button halfway again.

The instant manual override facility produces a convenient way of working. You can take advantage of autofocus while retaining an instantly adjustable manual focus check if preferred for pin-point accuracy without making any changes in the settings.

Another method for users who prefer more manual focus control while maintaining the benefits of the accuracy of autofocus is to set the camera to Manual focus and the User button to AF (Single) drive (see 'User button function list').

Focus is then adjusted manually with the focusing ring as normal but when the User button is pressed, the autofocus facility temporarily operates in AF S mode. After the new focus adjustment has been made automatically, the camera reverts immediately to manual focus control when the User button is released. Therefore, you can recompose the picture without having to maintain pressure on the release button in order to retain the newly automatically made focus setting.

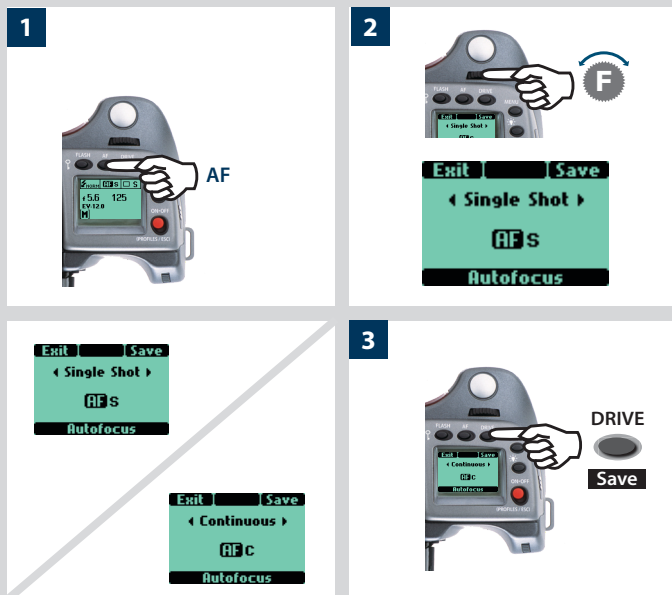

Drive

There are two drive modes, **Single** and **Continuous**, accessed by pressing the **DRIVE** button on the grip.

Single

In **Single** mode, an exposure is made when the shutter release button is pressed and the camera is made ready for the next exposure. To make the next exposure however, you must first release the shutter release button and then press again.

In camera active mode:

- 1) Press the **DRIVE** button on the grip.
- 2) Turn the front control wheel to: **Single**
- 3) Press **Save** to store the setting.

Continuous

In Continuous mode, the camera automatically makes exposures and makes ready for the next exposure in a continuous manner as long as you maintain pressure on the shutter release.

In camera active mode:

- 1) Press the **DRIVE** button on the grip.
- 2) Turn the front control wheel to: **Continuous**
- 3) Press **Save** to store the setting.

Multi exposure

In Multi exposure mode, the camera does not advance the film after the first exposure, only at the end of the pre-determined number of exposures. The frame options are: 2, 3, 4, 5 and 'No limit'.

In camera active mode:

- 1) Press the **DRIVE** button on the grip.
- 2) Turn the front control wheel to: **Multi exp.**
- 3) Turn the rear control wheel to select the number of frames required.
- 4) Press **Save** (**DRIVE** button) to store the setting.
- 5) The LCD will display firstly that no frames have been exposed in the multi-sequence (For example, in the case of a three exposure setting the display will be Exp:0/3).
- 6) Press the shutter release button to make the first exposure.
- 7) The LCD will display how many frames have been exposed in the sequence (In the case of a three exposure setting the display will now be Exp:1/3. After the next exposure, the LCD would then display 2/3 etc)
- 8) You can change your mind at any time to exit the sequence by pressing the **DRIVE** button to advance the film to the next frame. The camera is then prepared for another new multi exposure sequence according to the initial setting.

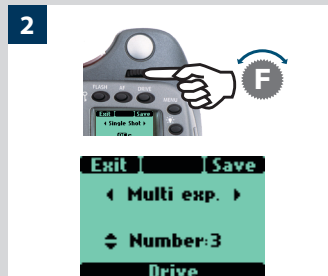
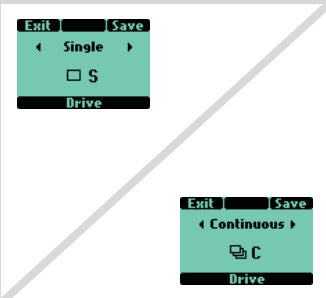
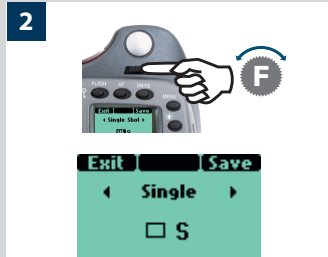

Profiles

The profiles feature allows rapid access to pre-determined combinations of settings that increase the speed and security of workflow. One example might be in a social situation where there might be a need for formal outdoor portraiture followed by informal indoor handheld flash-assisted wide-angle shots, both situations requiring very different settings in a stressful environment. By predetermining the relevant settings required beforehand for each situation, they can be saved collectively as a profile. By calling up the profile, you can then be assured that all the settings are correct at the press of one button.

For example, you might choose – autofocus single, bracketing, programmed exposure, etc – for outdoors. Once set, you would click on the red **PROFILES** button, select a profile name and press **SAVE**. A new name can be entered for the new profile - 'Outdoors', for instance - and saved again. New settings are made for the indoor shots changing to flash, Pv setting, etc and the procedure repeated. By simply accessing 'Outdoors' or 'Indoors' in the profile list, all the relevant settings will be instantly and correctly implemented to match the situation.

There are four profiles: **Standard**, **Full auto**, **Studio** and **Fill flash**. All except Standard can be changed and renamed.

The pre-set profiles feature the following:

Standard: normal flash sync, autofocus (single), single drive, autoexposure (aperture priority), average metering, user button -None

Full auto: normal flash sync, autofocus (single), single drive, programmed exposure, centre weighted metering, user button -None

Studio: normal flash sync, manual focus, single drive, manual exposure, spot metering. user button - AF drive

Fill flash: normal flash sync (adjusted output -1.7EV), autofocus (single), single drive, autoexposure, average metering.

All user profiles can be restored to default values again simply by removing the battery and holding down the **MENU** and **DRIVE** buttons together and while keeping them depressed, replace the battery. There will be an audible signal that denotes the restoration.

 All settings are stored when a profile is created. These profile settings will override the settings in use at the time the profile button was pressed. In other words, remember to check for unintentional settings when using profiles.

Making a profile

- 1) Activate the camera and go through the various settings (for example, autofocus, aperture priority, fill flash exposure compensation, etc.) you require for the particular purpose and save them as you go.
- 2) When all the required settings have been made, click (not press!) the **PROFILES** button (**ON.OFF** button) on the grip and the profile screen will appear.
- 3) Use either the front or rear control wheel to scroll through the list of profiles. Choose a profile name (except Standard). You can either save the new settings under this name or change the name you want to change.

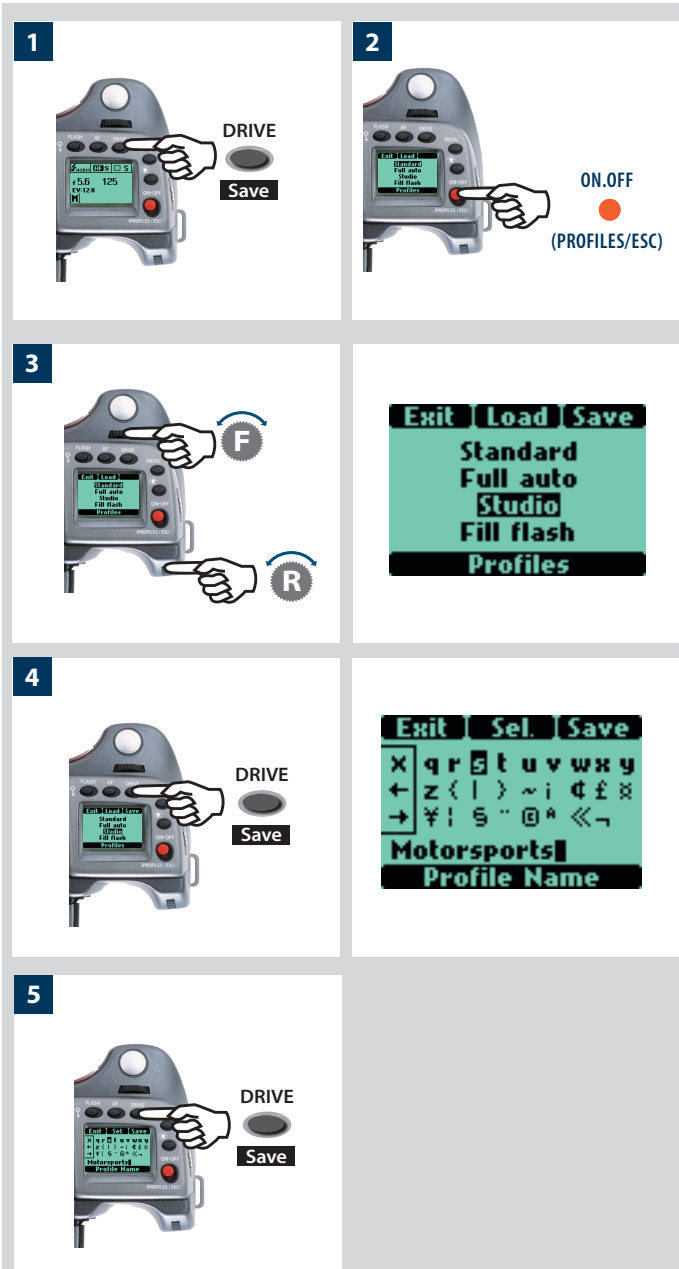

- 4) Press **Save (DRIVE button)**.

The Profile name screen is then displayed where you can rename the profile to what suits you (see section Imprint / Text 4.2.2 further on in this manual for procedure details).

- 5) Press **Save (DRIVE button)** to keep the combination of settings with the new name.

To use a profile from the main screen, press the **PROFILES** button to reach the profiles screen again. Scroll down the list to the profile you want and then press the **Load (AF)** button. All the saved settings will then be automatically implemented.

If you decided to change the settings but nevertheless keep the Profile name on the list, the new set of parameters will be retained under that name. That is to say, the settings will not be the same as listed here, despite the name. It might be safer practice to always change the profile name to avoid later confusion.

Using profiles

- 1) From the main screen, click **PROFILES (ON.OFF button)** on the grip and the profile screen will appear.
- 2) Use either the front or rear control wheel to scroll through the list and highlight the desired profile.
- 3) Press **Load (AF button)**. The camera is now set according to all the parameters stored according to the name.

Changing a profile name

You can change a profile name (except 'Standard') at any time.

Proceed as follows:

- 1) From the main screen, click **PROFILES (ON.OFF button)** on the grip and the profile screen will appear.
- 2) Use either the front or rear control wheel to scroll through the list and highlight the desired profile.
- 3) Press **Load (AF button)**.
- 4) Click **PROFILES (ON.OFF button)** again.
- 5) Press **Save (DRIVE button)**
- 6) The Profile name screen is then displayed where you can rename the profile to what suits you (see section Imprint / Text 4.2.2 further on in this manual for procedure details).

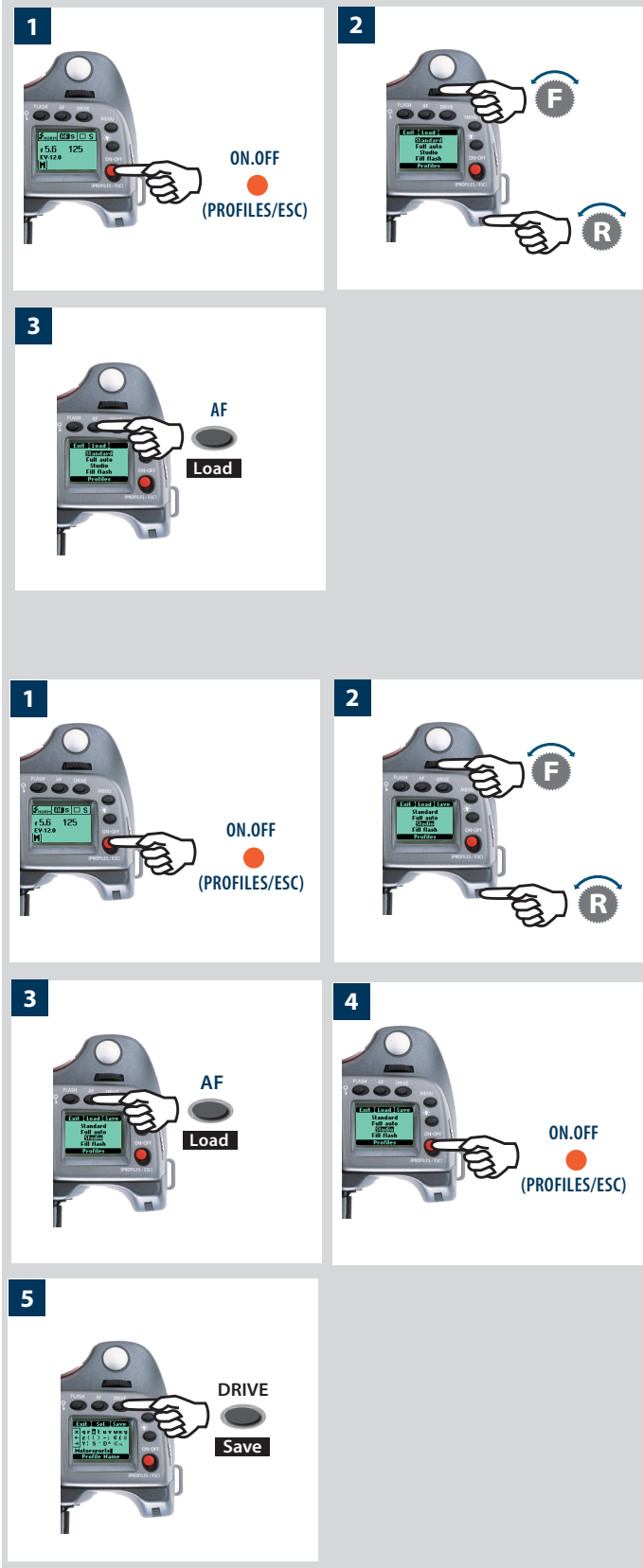

9

Advanced Features

- Programmable self timer
- Programmable bracketing
- Programmable interval setting
- 30 custom options
- Data and text imprinting

This section describes the features that might not need to be accessed everyday but should be exploited wisely to obtain the optimum from the system.

Some features are a little more special, bracketing for example. This is fairly normal practice for many photographers and the H system can provide a good deal of control and fine tuning of this particular feature.

Thirty custom options are provided to work for you in the background, ensuring security and also helping to bring down the barriers between you and capturing the image. Each one can be changed to suit your preferences so that the whole camera becomes a reflection of the way you like to work.

General overview of camera menu

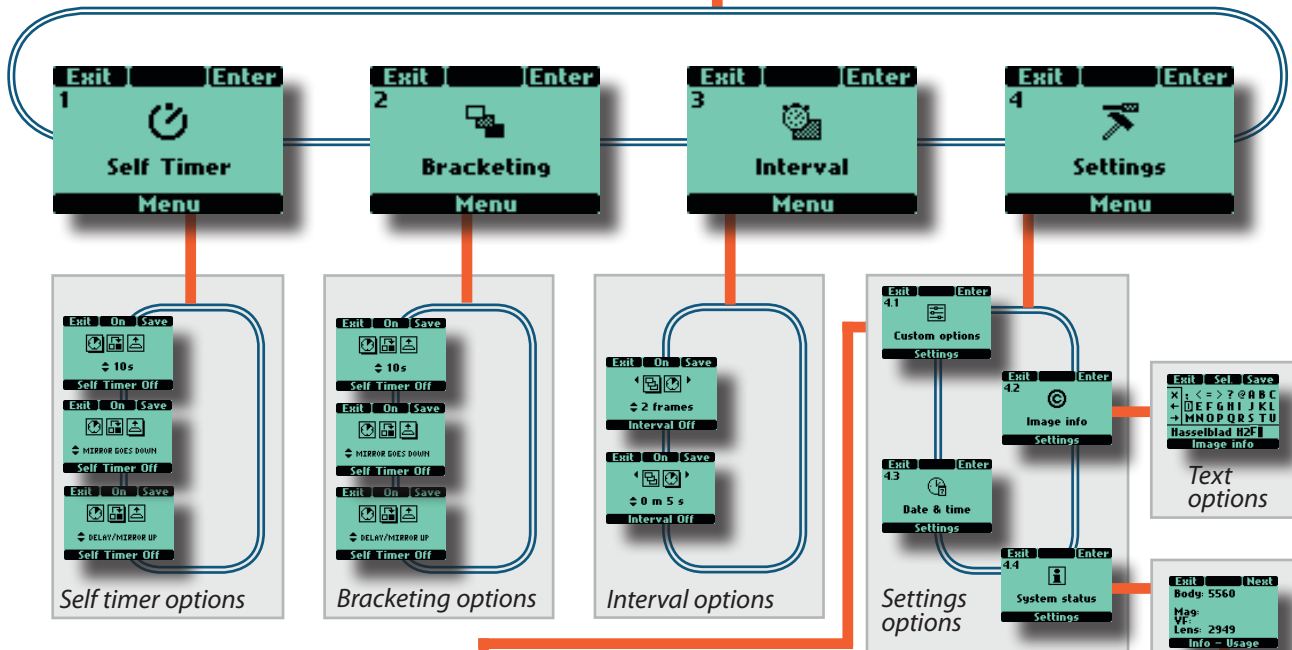
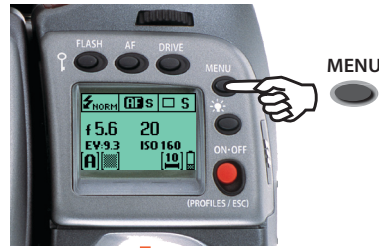

Exit Save 1 Standby timeout 10s Custom options	Exit Save 2 Ev increment 1/2 Step Custom options	Exit Save 3 Exp. adjust increment 1/3 Step Custom options	Exit Save 4 User button function AF Drive Custom options	Exit Save 5 AE-L button function AE-Lock Custom options
Exit Save 6 Stop down button function Stop down Custom options	Exit Save 7 M.U.P button function Mirror up Custom options	Exit Save 8 Control wheel direction Clockwise Custom options	Exit Save 9 Flash ready exposure lock Yes Custom options	Exit Save 10 Magazine exposure lock No Custom options
Exit Save 11 Lens exposure lock Yes Custom options	Exit Save 12 Out of range exposure lock No Custom options	Exit Save 13 True exposure On Custom options	Exit Save 14 Spot mode Normal Custom options	Exit Save 15 Focus aid in MF Half press Custom options
Exit Save 16 AF assist light Ext. flash Custom options	Exit Save 17 Rear wheel quick adjust Yes Custom options	Exit Save 18 Control lock All controls Custom options	Exit Save 19 Film wind-on Half press Custom options	Exit Save 20 Beeper On Custom options
Exit Save 21 Interval & Self timer Exit Custom options	Exit Save 22 AE-lock / Quick adjust Exp reset Custom options	Exit Save 23 Show EV Yes Custom options	Exit Save 24 Show ISO Yes Custom options	Exit Save 25 Bracket param. in Manual Shutter speed Custom options
Exit Save 26 Aperture ctrl. in Manual Front wheel Custom options	Exit Save 27 Low flash warning On Custom options	Exit Save 28 Interval timer initial delay None Custom options	Exit Save 29 Aperture indication Normal Custom options	Exit Save 30 Extra mirror delay 50 ms Custom options

There are a number of more advanced features that while not necessarily used every day still remain immediately accessible through the menu system. They provide the integral finesses that make the H2F a powerful and sophisticated tool to satisfy a variety of professional demands.

There are four main functions:

1. Self timer
2. Bracketing
3. Interval timer
4. Settings
5. Digital

An important point to remember is that certain options are only available when the relevant screen has been accessed. For example, in Self Timer the choice of 'delay/mirror up' or 'mirror up/ delay' is only available (by turning the rear control wheel - lower row on display) when the relevant function has been chosen (by turning the front control wheel - upper row on display)

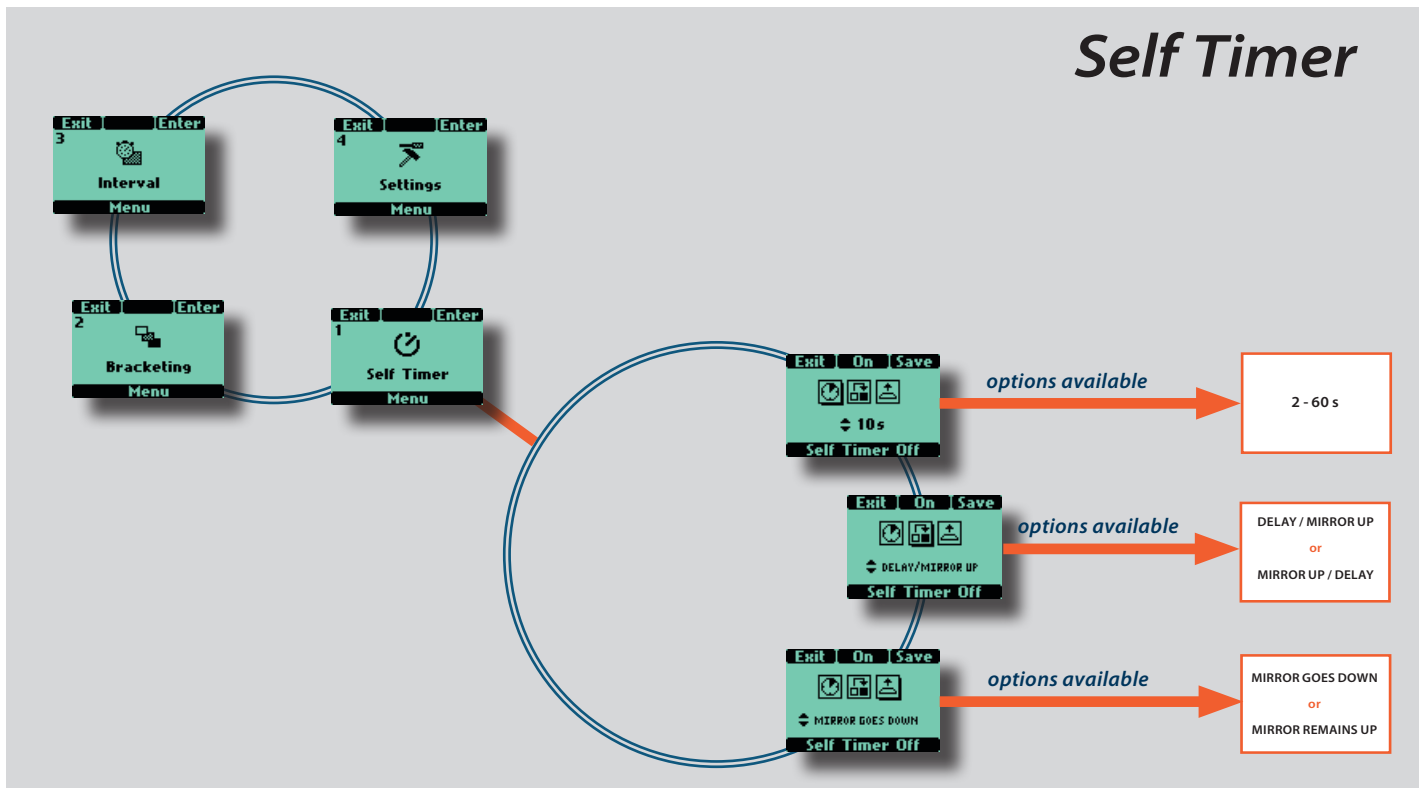

1 Self timer

The self timer allows a delay in the activation of the shutter and a change in sequence of the mirror movement. Normally the mirror is raised before the shutter is tripped creating a pause between the two actions to minimize camera vibration. However, during this pause there will be no image in the viewfinder and no light metering available for any eventual exposure change. Therefore the Self timer function can be set to a sequence where the delay is followed by the mirror being raised instead. Normally the mirror will instantly return after an exposure but you can also choose a setting where the mirror remains raised. The Self Timer can be set to provide virtually vibration-free shutter release. It can be used instead of a remote release cable/cord/device when split-second timing is not critical. The camera's exposure settings (Manual or Auto) will be according to the light metering requirements just prior to the mirror being raised so choose your method accordingly with long delays in very changeable lighting conditions.

The Self timer function is set in the following manner:

- 1) Press the **MENU** button on the grip.
- 2) Turn the front control wheel until **Self Timer** appears.
- 3) Press **ENTER (DRIVE button)** on the grip.
- 4) Turn the front control wheel to access the options, that are:



Delay



Mirror sequence



Mirror Up / Mirror Goes Down

(A drop shadow will be displayed beneath the selected symbol, for example)

- 5) When **Delay** is highlighted - - turn the rear control wheel to choose a delay range from 2 - 60s in 1s intervals.
- 6) Turn the front control wheel again to choose **Delay / Mirror Up, Mirror Up/ Delay** sequence - . When highlighted turn the rear control wheel to choose.

Delay / Mirror Up sequence =

Delay for set amount of time — mirror raised — exposure made.

Mirror Up/ Delay sequence =

Mirror raised — delay for set amount of time — exposure made.

- 7) Turn the front control wheel again for **Mirror goes down / Mirror remains up** - - choice. Turn the rear control wheel to choose.

Mirror goes down =

Mirror returns to its normal position and the camera is made ready for the next exposure.

Mirror raised =

Mirror remains in raised position. No image is visible in the viewfinder until M UP button pressed.

- 8) Press **On (AF button)**. Note that this now reads **Off** and the line of text at the bottom of the screen reads '**Self timer on**'.
- 9) Press **SAVE (DRIVE button)** to save the setting.
- 10) Press **ENTER (DRIVE button)** again from the Self Timer screen to activate the function.

- 11) Click **On (AF button)**.

- 12) Half-press the shutter release button to standby mode for this function (press the shutter release button again (full press) for activation) or full-press the shutter release for immediate activation.

Check the lower text-row on the screen for ON or OFF status.

You can halt the sequence by clicking the ON / OFF (ESC) button.

1 MENU

2 F

3 DRIVE Enter

4 F

5 R

Exit On Save
10s
Self Timer Off

'Delay' highlighted with drop shadow. 10 seconds chosen.

6 R

Exit On Save
DELAY/MIRROR UP
Self Timer Off

Mirror sequence highlighted. 'Delay first, then mirror raised' chosen as option.

7 F

Exit On Save
MIRROR GOES DOWN
Self Timer Off

Mirror down /up highlighted. 'Mirror down after exposure' chosen as option.

8 AF On

Exit Off Save
MIRROR GOES DOWN
Self timer On

9 DRIVE Save

10 DRIVE Enter

11 AF On

12

Bracketing

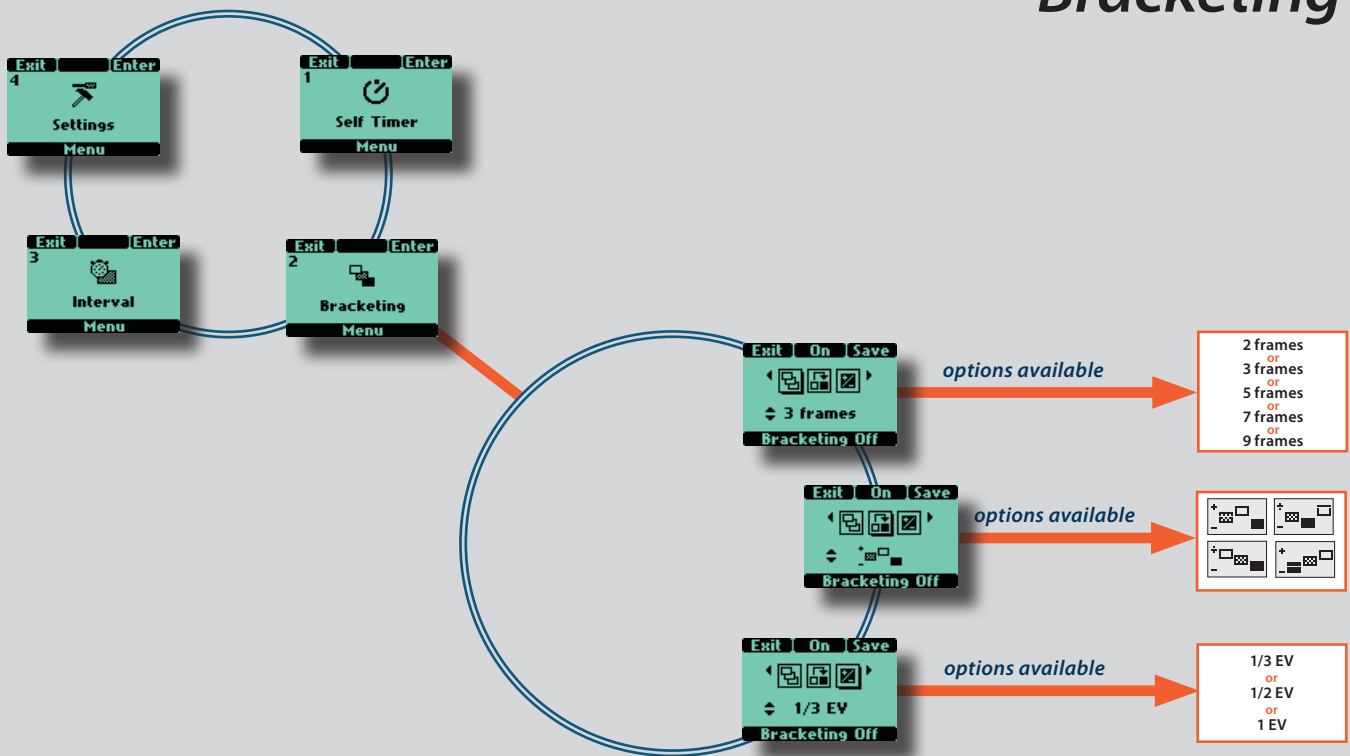

2 Bracketing

The bracketing facility provides an automatic series of exposures; one at the standard exposure setting (Manual or Auto) and the others with pre-determined deviations in EV from the standard exposure. This is particularly useful for images containing a very wide tonal range, for example.

Firstly you make an assessment concerning the number of extra frames required, the order in which they should be taken, and by how much EV deviations there should be and the setting made accordingly. The first metered exposure (Manual or Auto) is the EV that determines the calculations for the bracketing sequence.

Note the difference in operation between **Single** and **Continuous** drive settings:

- In **Single** you must press the shutter release button separately for every separate exposure until the sequence is finished.
- In **Continuous** you can either maintain the pressure on the button to take all frames without stopping or you can release the pressure on the button and press again to continue to the end of the sequence without losing any frames within the set sequence.

The Bracketing function is set in the following manner:

- 1) Press the **MENU** button.
- 2) Turn the front control wheel until **Bracketing** appears
- 3) Press **Enter (DRIVE)** button on the grip
- 4) Turn the front control wheel to access the options, that are:
 - Number of Exposures** (the number of exposures required in the sequence)
 - Sequence** (the sequential order of the over- or under- exposures)
 - Step** (the amount of EV variation from the standard exposure setting)

(A drop shadow will be displayed beneath the selected symbol, for example)

- 5) In turn the rear wheel to choose the number of frames required: 2, 3, 5, 7 or 9.
- 6) In turn the rear wheel to choose one of four sequences:
 - A: Standard, Over, Under
 - B: Standard, Under, Over
 - C: Over, Standard, Under
 - D: Under, Standard, Over
- 7) In turn the rear wheel to choose the amount of EV variation required: 1, 1/2, 1/3 EV.
- 8) Press **SAVE (DRIVE button)** to save the setting.
- 9) Press **ENTER (DRIVE button)** again from the Bracketing screen to activate the function. Press **On (AF button)**. Note that this now reads **Off** and the line of text at the bottom of the screen reads **'Bracketing on'**.

Half-press the shutter release button to standby mode for this function (press the shutter release button again (full press) for activation) or full-press the shutter release for immediate activation.

To escape from this mode press **MENU**, then **Enter (DRIVE button)** on the Bracketing screen, then **Off (AF button)**.

- Check the lower text-row on the screen for ON or OFF status
- The default setting is a shutter speed change in a bracketing sequence. However, if the camera is set in Manual mode, you can choose an aperture change instead (Custom Options - Bracket param. in Manual - 26).
- See note at the beginning of this section regarding the difference between Single and Continuous drive settings. In both cases, the bracketing function is automatically reset for a new sequence.
- A bracketing sequence can be stopped mid-sequence by pressing the ESC (ON.OFF) button.
- As an example, a 5 frame sequence with an EV 1 variation setting at 'Standard, Over, Under' would produce: Standard (0 EV variation), +1EV, -1EV, +2EV, -2EV. SEnS

1

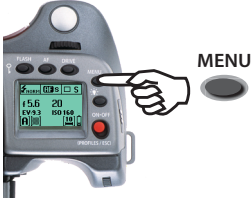

2

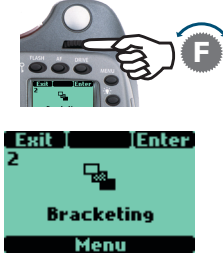

3



4



5

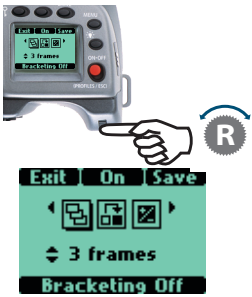

Number of exposures highlighted. 3 frames chosen as option.

6

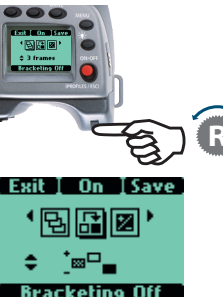

Sequence highlighted. 'Standard, over, under' chosen as option.

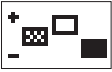

A

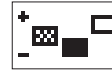

B



C



D

7

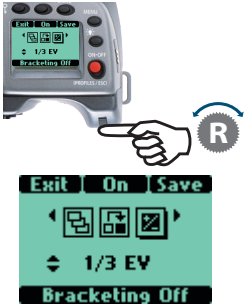

Step highlighted. 1/3 EV variation chosen as option.

8



9



EXAMPLE

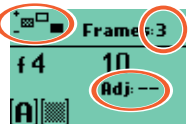

Screen after Bracketing setting activated indicating 3 frames remaining in a Standard, Over, Under, sequence with no adjustment to the next frame.

Interval

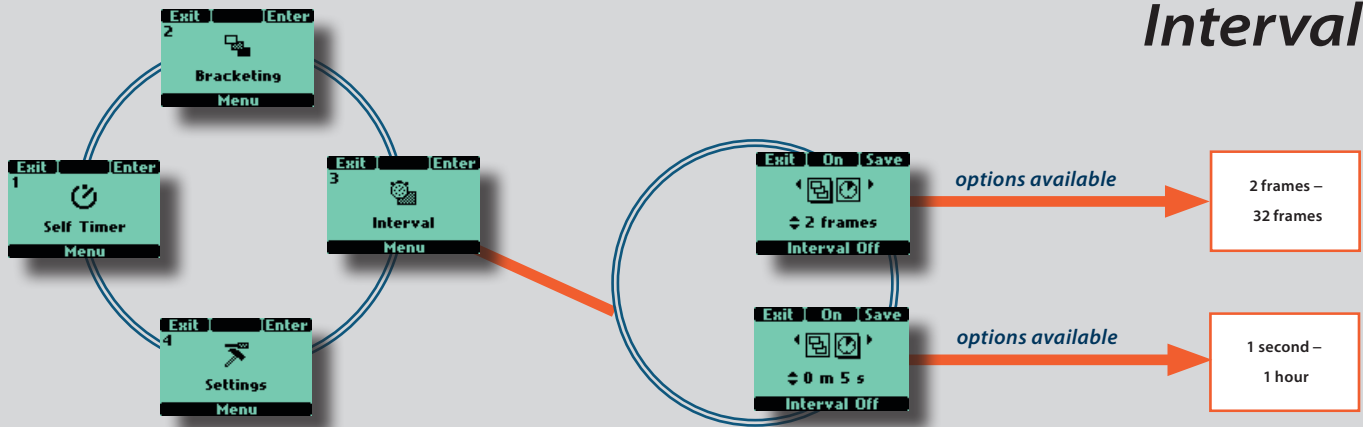

3 Interval

By using the interval setting, you can allow the camera to take a series of exposures automatically over a set period. This is often required for time and motion studies, security surveillance, nature study, etc. The exposure and focus settings (Manual or Auto) will be according to the camera settings at the time of exposure.

Interval setting

- 1) Press the **MENU** button on the grip.
- 2) Turn the front control wheel until **Interval** appears.
- 3) Press the **DRIVE (Enter)** button on the grip.
- 4) Turn the front control wheel to access the options, that are:



Number of exposures

(the number of exposures required)



Interval duration

(the time interval between the exposures)
(The chosen symbol is indicated by a drop shadow)

- 5) In Number of exposures, turn the rear wheel to choose the number of exposures required: 2 – 32
- 6) In Interval duration, turn the rear wheel to choose:
 - 1 second – 1 hour
- 7) Press **SAVE (DRIVE button)** to save the setting.
- 8) Press **ENTER (DRIVE button)** again from the Interval screen to activate the function. Press **On (AF button)**. Note that this now reads **Off** and the line of text at the bottom of the screen reads '**Interval on**'.

Half-press the shutter release button to standby mode for this function (press the shutter release button again (full press) for activation) or full-press the shutter release for immediate activation.

- In Custom Options #29 you can select an initial delay of None, 2, 10, 60 seconds or the interval time.
- Check the lower text-row on the screen for ON or OFF status.
- An Interval setting can be stopped mid-sequence by pressing the ESC button.

1

MENU

2

Interval Menu

3

DRIVE
Enter

4

Interval Menu

5

Interval Off
2 frames

Number of exposures highlighted. 2 frames variation chosen as option.

6

Interval Off
0 m 5 s

Interval duration highlighted. 5 seconds variation chosen as option.

7

DRIVE
Save

8

DRIVE
Enter
AF
ON

EXAMPLE

Shots: 3
f 3.5 15
Time: 0m 30s

Screen after Interval setting activated indicating 3 shots remaining at 30 second intervals.

Settings / Custom Options

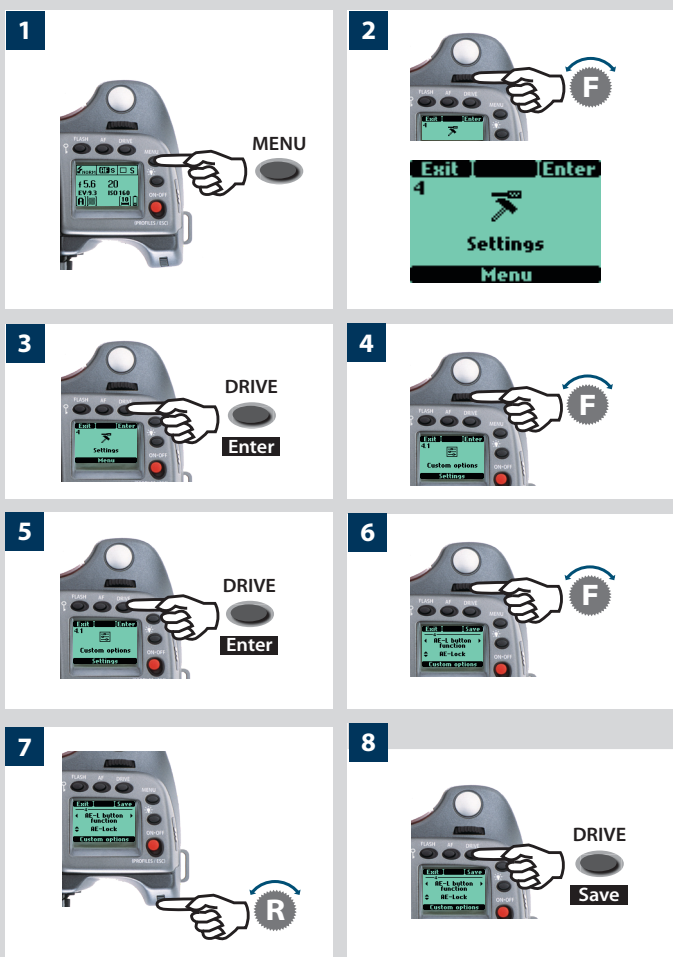
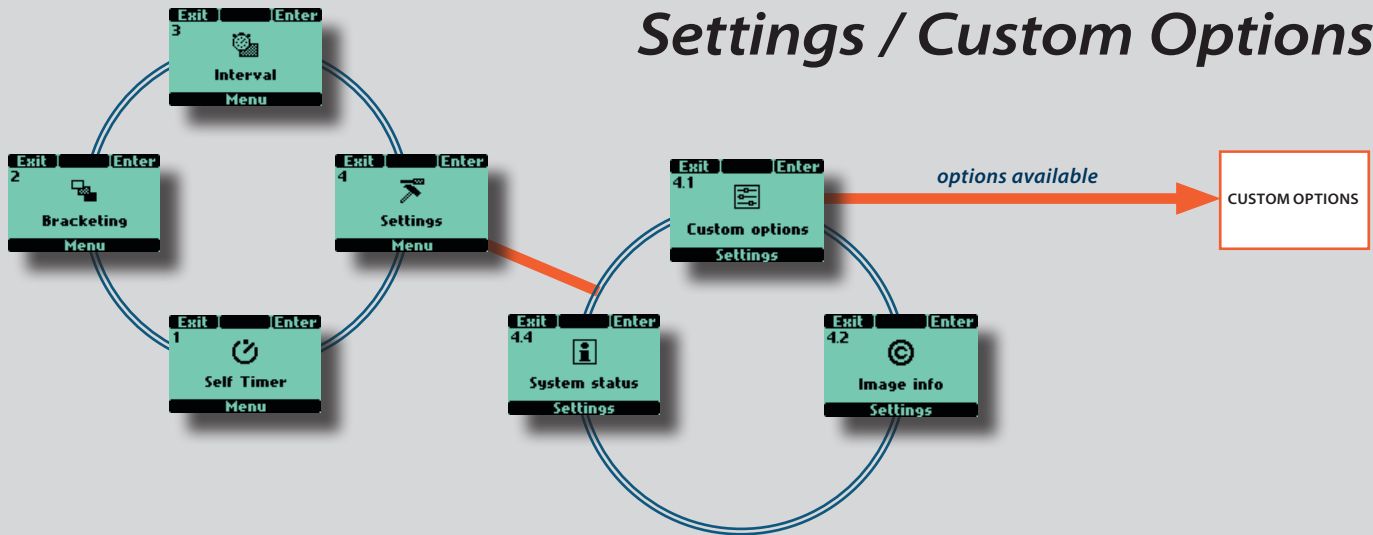

4 Settings

From the **Settings** screen you can access three main sub-settings: **Custom options**, **Image Info** and **System status** by turning the front control wheel. From each of these three sub-settings you can access further screens. **Custom options** has 32 screens, **Image info** has two more screens each with more choices and **System status** has two more screens. Look at the main menu chart to get an idea of where all the options are on the menu tree

4.1 Custom options

- 1) Press the **MENU** button on the grip.
- 2) Turn the front control wheel until **Settings** appears.
- 3) Press the **DRIVE (Enter)** button on the grip.
- 4) Turn the front control wheel to access **4.1 Custom options**.
- 5) Press the **DRIVE (Enter)** button to access the 32 choices available.
- 6) Turn the front control wheel to the desired Option.
- 7) Turn the rear control wheel to the desired Setting.
- 8) Press **Save**

 As a shortcut to the Custom Option level, press **MENU** and then the **USER** button. After making any changes, press the shutter release button to save the new setting.

In the following list, the options marked in red are the default settings. So, in the case of the User button, for example, as None is the default there will be no reaction from the camera until you make a specific choice and save it.

If you want to reset the sensor unit to the default setting for all options, press the **ON.OFF** button quickly to enter **Profiles**, select **Standard** and then press **Load**.



Standby timeout 1

- 5s • 10s • 15s • 30s

Determines the amount of time the camera remains active before it automatically reverts to standby mode (indicated on the grip LCD by the H2F logo). Minimises battery consumption.



EV increment 2

- 1 Step • 1/3 Step • 1/2 Step

Determines the amount of EV change applied (per click of either the front or rear control wheels) to either aperture or shutter speed.



Exp adjust increment 3

- 1 Step • 1/3 Step • 1/2 Step

Determines the amount of EV change applied (per click of the rear control wheels) when making fixed exposure adjustment settings.



User button function 4

- None •

but can be reassigned to:

- Standby (enters standby) • Stop Down • Flash Measure • Interval timer • Multi exposure • Self Timer • Bracketing • AF drive (lens in MF or AF) • Mirror up • B mode • T mode • Histogram • Gray bal Exp. • Cycle LM mode • Delete last img. • Dig. foc. Check • IAA toggle • Expose • AE lock

Sets which function will be immediately activated when the User button is pressed (you cannot alter the setting in this mode though, only use it). The button has a toggle function so that by pressing it again the new setting will be de-activated.



AE-L button function 5

- AE-lock

but can be reassigned to:

- None • Standby (enters standby) • Stop Down • Flash Measure • Interval timer • Multi exposure • Self Timer • Bracketing • AF drive (lens in MF or AF) • Mirror up • B mode • T mode • Histogram • Gray bal Exp. • Cycle LM mode • Delete last img. • Dig. foc. Check • IAA toggle • Expose • AE lock



Stop down button function 6

- Stop Down

but can be reassigned to:

- None • Standby (enters standby) • Flash Measure • Interval timer • Multi exposure • Self Timer • Bracketing • AF drive (lens in MF or AF) • Mirror up • B mode • T mode • Histogram • Gray bal Exp. • Cycle LM mode • Delete last img. • Dig. foc. Check • IAA toggle • Expose • AE lock



M.UP button function 7

- Mirror up

but can be reassigned to:

- None • Standby (enters standby) • Flash Measure • Interval timer • Multi exposure • Self Timer • Bracketing • AF drive (lens in MF or AF) • Stop Down • B mode • T mode • Histogram • Gray bal Exp. • Cycle LM mode • Delete last img. • Dig. foc. Check • IAA toggle • Expose • AE lock



Control wheel direction 8

- Clockwise • Counter clockwise

Determines the effect the direction of the controls wheels have on a setting.

For example, by moving the front control wheel to the left you can alter the aperture setting from f/8 to f/6.8 to f/5.6 and so on. By changing the wheel direction setting however, the same action of turning the wheel to the left would then produce the opposite effect, that is, the aperture settings would change from f/ 8 to f/ 9.5 to f/ 11, and so on.



Flash ready exposure lock 9

- Yes • No

Allows you to make an exposure before the flash is fully charged. For use with integral flash unit or other TTL compatible flash units connected to the hot-shoe. Not valid for flash units connected by the PC connector.

Yes blocks the shutter until flash is ready.

No allows shutter release before flash is ready.



Magazine exposure lock 10

- **Yes** • **No**

Allows you to release the camera without a film loaded in the magazine.

Yes blocks the shutter if there is no film in the magazine and also displays a message on the grip LCD: *No film*.

No allows the shutter to be released with no film in the magazine.

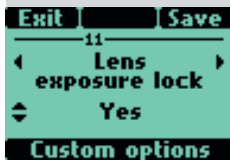

Lens exposure lock 11

- **Yes** • **No**

Allows you to release the camera without a lens attached.

Yes blocks the shutter if there is no lens attached and also displays a message on the grip LCD: *No lens*.

No allows the camera to perform a release operation without a lens.



Out of range exposure lock 12

- **Yes** • **No**

Allows you to release the camera when either the aperture or shutter speed setting is beyond the working range (indicated on the LCDs by “—”).

Yes blocks the shutter if beyond the working range.

No allows the shutter to be released if beyond the working range.



True exposure 13

- **On** • **Off**

Determines whether the exposure is automatically adjusted to create a true exposure setting. (See Appendix, Glossary of Terms for full explanation).

On allows the adjustment.

Off retains the normal setting.



Spot mode 14

- **Normal** • **Zone**

Determines how the camera behaves when set to Spot Mode.

Normal makes the camera behave in the same fashion as when set to Average or Centre Weighted.

Zone makes the camera behave in the same fashion as the Hasselblad 205FCC. That is, the central spot is placed over a particular area of the subject and the AE-L button is pressed. The exposure is then calculated assuming that the metered area is 18% grey or Zone 5 and is indicated on the LCD as Zone 5 (see Appendix / Glossary of Terms). Alternatively, the area can be reassigned to another zone by turning the rear control wheel.

Then, when the camera is moved, the areas within the central spot are indicated by their zone values.



Focus aid in MF 15

- **Half press** • **Always** • **Off**

Sets how the focus aid arrowhead LED symbols appear in the viewfinder display in manual focus mode.

Half press makes them visible when the shutter release button is pressed half way.

Always makes them visible all of the time when camera is active.

Off disables them completely.

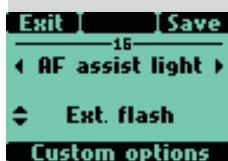

AF assist light 16

- **Camera** • **Ext flash** • **Off**

Allows projection of light pattern to assist the autofocus system in poor light or low contrast situations.

Camera sets the integral AF assist illumination to be always active.

External flash activates the AF assist illumination projected by a suitable attached external flash unit. When detached, however, the integral system is automatically used.

Off sets the AF assist illumination to remain always inactive.



Rear wheel quick adjust 17

• **Yes** • No

Allows rear control wheel to make a rapid EV adjustment (or EV compensation) in auto-exposure mode.

Yes turns the setting on. By turning the rear control wheel, the adjustment is made and appears on both LCDs as a \pm symbol between the shutter speed and aperture values. The amount of deviation also appears above the scale to the left of the aperture value on the viewfinder LCD.

No turns the function off completely.



Control lock 18

• **All controls** • Wheels • Off

Sets the amount of locking used when the Control Lock button is pressed.

All controls locks control wheels and buttons.

Wheels locks only control wheels. They remain operable in any setting mode, however.

Off disables lock function.



Film wind-on 19

• **Direct** • Half press

Sets when the film will be advanced to the first frame.

Direct advances film automatically to the first frame when the film holder is inserted or when the magazine is attached.

Half press advances the film only when the shutter release is pressed to half press position.



Beeper 20

• **On** • Off

Sets the audible beeper signal.

On enables the signal.

Off disables the signal.

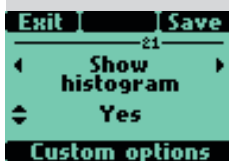

Show histogram 21

• **Yes** • No

Sets whether a histogram of a digital exposure appears on the LCD after exposure. Only for use together with digital backs that support this feature.

Yes enables the setting.

No disables the setting.



Interval & Self Timer 22

• **Exit** • Stay

Allows either the Interval or Self Timer mode to remain active after an exposure or immediately return to standard setting.

Exit clears the setting and produces an automatic return to standard setting after an exposure.

Stay retains the setting after an exposure.



AE lock/ Quick adjust 23

• **Exp reset** • Saved

Allows either the AE-Lock or Quick adjust mode to remain active after an exposure or immediately return to standard setting.

Exp Reset clears the settings and produces an automatic return to standard setting after an exposure.

Saved retains the AE-Lock or Quick adjust settings after an exposure.



Show EV 24

• **Yes** • No

Allows the display of EV settings on the grip LCD.

Yes enables the display.

No disables the display.

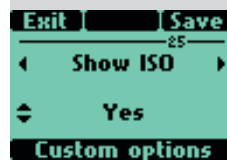

Show ISO 25

• **Yes** • No

Allows the display of ISO settings on the grip LCD

Yes enables the display.

No disables the display.



Bracket param. in Manual 26

• **Shutter speed** • Aperture

Selects either the shutter speed or the aperture as the parameter which changes in a bracketing sequence when in Manual exposure mode.

Shutter speed selects changes in shutter speed.

Aperture selects changes in aperture settings.



Aperture control in Manual 27

- **Front wheel** • **Rear wheel**

Selects which control wheel changes the aperture setting when in Manual exposure mode.

Front wheel selects the front control wheel to change the aperture setting.

Rear wheel selects the rear control wheel to change the aperture setting.

Low flash warning 28

- **On** • **Off**

Controls the display of the 'Low flash' warning message and triangle.

ON enables the function.

OFF disables the function.

Interval timer initial delay 29

- **None** • **2s** • **10s** • **60s** • **Interval time**

Allows an initial delay before the first exposure of an interval timer function operation.

Aperture indication 30

- **Normal** • **Light meter**

Allows choice of aperture indication display (in Manual mode only).

Normal selects conventional display (*f5.6, f8, etc*)

Light meter selects 'light meter' type display (*f5.6⁰, f8.⁵, etc*)

Extra mirror-delay 31

- **50ms** • **5 ms** • **10 ms** • **20 ms** • **50 ms** • **100 ms** • **200 ms** • **400 ms**

Extends the delay period between the mirror being raised and the opening of the lens shutter thereby reducing the effect of vibration on longer exposure times.

ISO / WB menu 32

- **Menu** • **Flash** • **AF** • **Drive**

Re-assigns the Flash, AF or Drive button on the grip to directly access the ISO / White balance setting screen.

Image Info / Imprint type

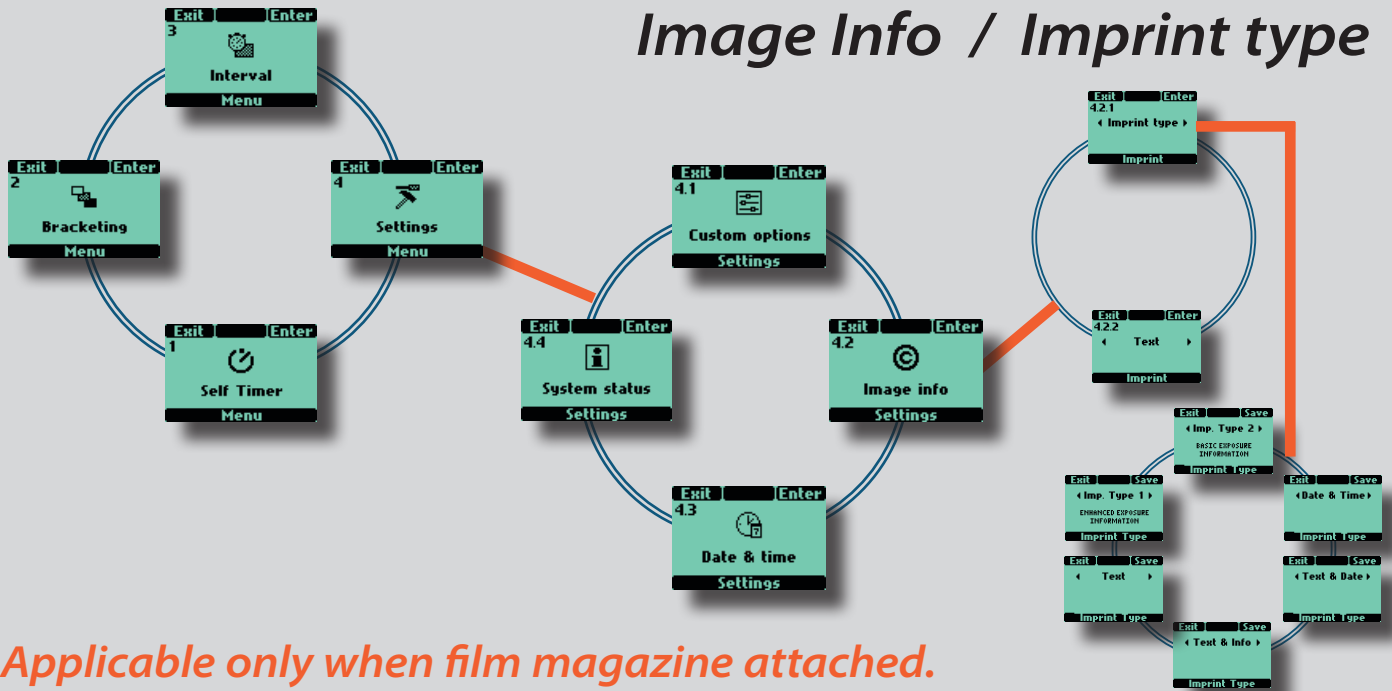

Applicable only when film magazine attached.

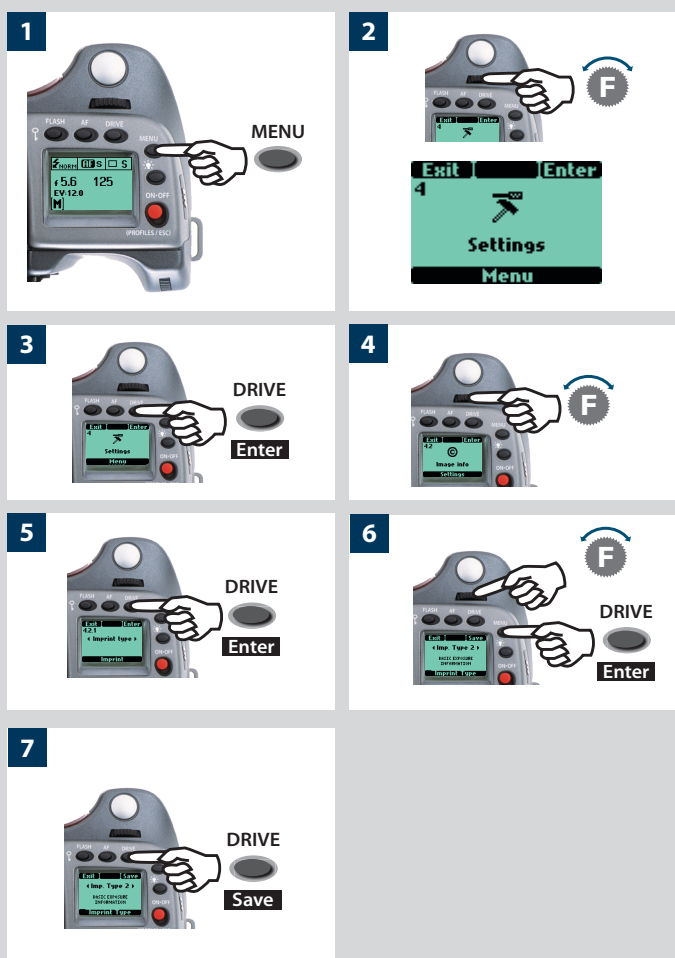

4.2 Image Info

The *Imprint* facility controls the text that will appear along the edge of each frame on a film. It is possible to imprint approximately 40 characters at one time.

Imprint Type records technical information automatically created by the camera. **Text** records information created by the user.

4.2.1 Imprint type

The following can be chosen as an option:

- **Imp. Type 1** prints the relevant information: aperture, shutter, metering mode, exposure mode, exposure compensation and flash compensation.
- **Imp. Type 2** prints the relevant basic information only: aperture, shutter, and exposure correction.
- **Date & Time** prints date & time only (the correct date and time is set through the Settings menu under 'Date & Time'.)
- **Text & Date** prints text plus date
- **Text & Info** prints text plus basic info
- **Text** prints text only (that you have created in 4.2.2 Text)

Imprint type setting

- 1) Press the **MENU** button on the grip.
- 2) Turn the front control wheel until **Settings** appears.
- 3) Press **Enter** (**DRIVE** button) on the grip.
- 4) Turn the front control wheel to access **4.2 Image info**.
- 5) Press **Enter** (**DRIVE** button) to **4.2.1 Imprint type**.
- 6) Press **Enter** (**DRIVE** button) again and turn the front control wheel to select the desired option.
- 8) Press **Save** (**DRIVE** button) on the grip.

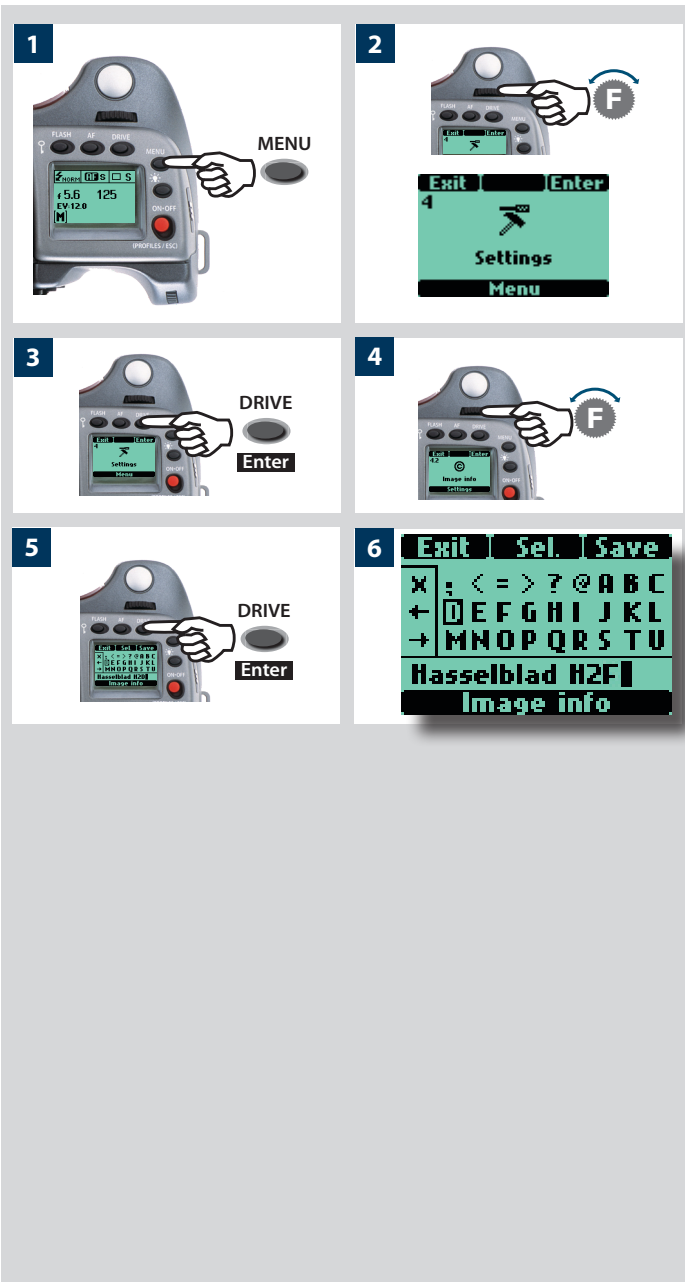
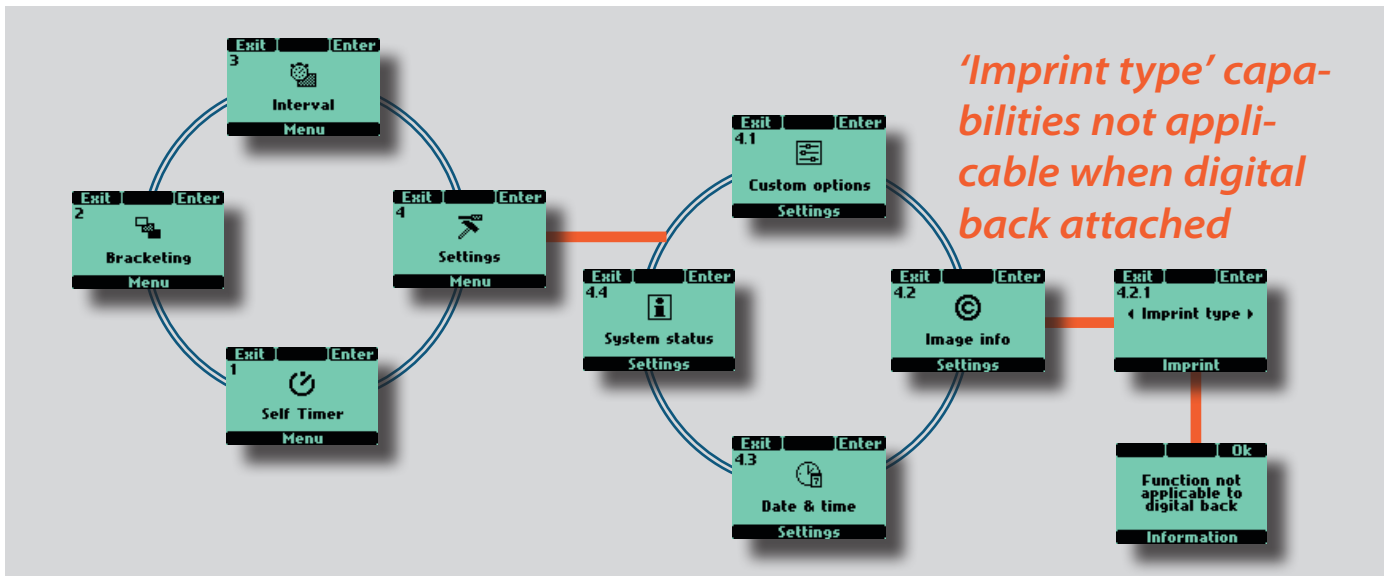

4.2.2 Text

In Image info you can compose your own combination of letters, words, symbols, etc to be included in the metadata. The same procedure is also used to change a Profile name.

- 1) Press the **MENU** button on the grip.
 - 2) Turn the front control wheel until **Settings** appears.
 - 3) Press the **Enter (DRIVE)** button on the grip.
 - 4) Turn the front control wheel to access **4.2 Image info**.
 - 5) Press the **Enter (DRIVE)** button to **4.2.2 Text**.
- 6) On the left side of the screen there is a small box frame containing an **X** symbol and two arrow symbols. By turning the front control wheel, the selector cursor will enter the box and by turning the rear control wheel the selector cursor will move up and down.
 - When the **X** in the box is highlighted and the **Sel.(AF)** button is pressed, the character highlighted in the text line lower down the screen will be deleted.
 - When an arrow in the box is highlighted, the text line cursor moves along the text line in the arrow's direction, moving past every character with every click on the **Sel.(AF)** button to the desired position. The highlighted character in the text line can then be replaced by a new character chosen by moving the selector cursor out of the box, positioning it over the new character to highlight it, and then pressing the **Sel.(AF)** button.
 - By turning the front control wheel, the cursor moves horizontally.
 - By turning the rear control wheel, the cursor moves vertically and introduces all available characters by scrolling the screen.

So, to write and store the characters, proceed as follows:

- 1) You can firstly clear an unwanted line of text by highlighting the **X** symbol in the box and repeatedly pressing the **Sel.(AF)** button.
- 2) Find the character you want by scrolling with the rear control wheel until it appears on the screen. (The 'space' character is the 'empty space' to the left of the exclamation mark, top row furthest to the left).
- 3) Move the selector cursor with a combination of the front and rear control wheels until the desired character is highlighted.
- 4) Press the **Sel.(AF)** button to save the character that will then appear in the text line along the lower part of the screen.
Continue with the same procedure until you have completed the line of characters and symbols.
- 5) Press the **Save (DRIVE)** button to store the new setting.

Changing text - an example

Here is an example of how to change existing text (in this case the word 'Text' to a copyright symbol plus a photographer's name - 'Jens Karlsson'). See previous section '4.2.2 Image info for procedure description.

- 1) Start by accessing the **Image info** screen. On the text row towards the bottom of the screen, the text line cursor is automatically placed to the right of the character that is to be changed. Turn the front and rear control wheels to move the selector cursor until the **X** symbol is highlighted.
- 2) Press **Sel. (AF button)** and the character will be erased.
- 3) Repeated pressing of **Sel.** will progressively erase all the characters in the line.
- 4) After erasing unwanted text, turn the front and rear control wheels until the desired character is highlighted by the selector cursor (in this case the copyright symbol) and press **Save**. Note that more symbols have automatically appeared as you scrolled down the screen.
- 5) Choose the next character in the same manner (in this case a space) and press **Save**.
- 6) The capital letter 'J' has been highlighted and saved in this example.
- 7) Repeat the procedure until all the letters and characters you want appear. As you progress with more characters, those to the left will temporarily disappear from the screen so that you can see what you are adding. Don't forget there is a maximum of approximately 40 characters.
If you make a mistake you must remove each character singly (see steps 1-3 above) until you reach where you want to make a change and then return to the 'Adding text' procedure again.
- 8) This example shows a completed 15 character text line with symbols, spaces, upper and lower case (large and small) letters.

The images illustrate the following steps:

1. The screen shows a menu with 'Text' highlighted. A hand points to the 'Sel.' button. A 'Save' button is also visible.
2. The screen shows the 'Text' line with an 'X' symbol highlighted. A hand points to the 'Sel.' button.
3. The screen shows the 'Text' line with the 'X' symbol highlighted. A hand points to the 'Sel.' button.
4. The screen shows the 'Text' line with the 'X' symbol highlighted. A hand points to the 'Sel.' button.
5. The screen shows the 'Text' line with the 'X' symbol highlighted. A hand points to the 'Sel.' button.
6. The screen shows the 'Text' line with the 'X' symbol highlighted. A hand points to the 'Sel.' button.
7. The screen shows the 'Text' line with the 'X' symbol highlighted. A hand points to the 'Sel.' button.
8. The screen shows the 'Text' line with the 'X' symbol highlighted. A hand points to the 'Sel.' button.

Date & Time

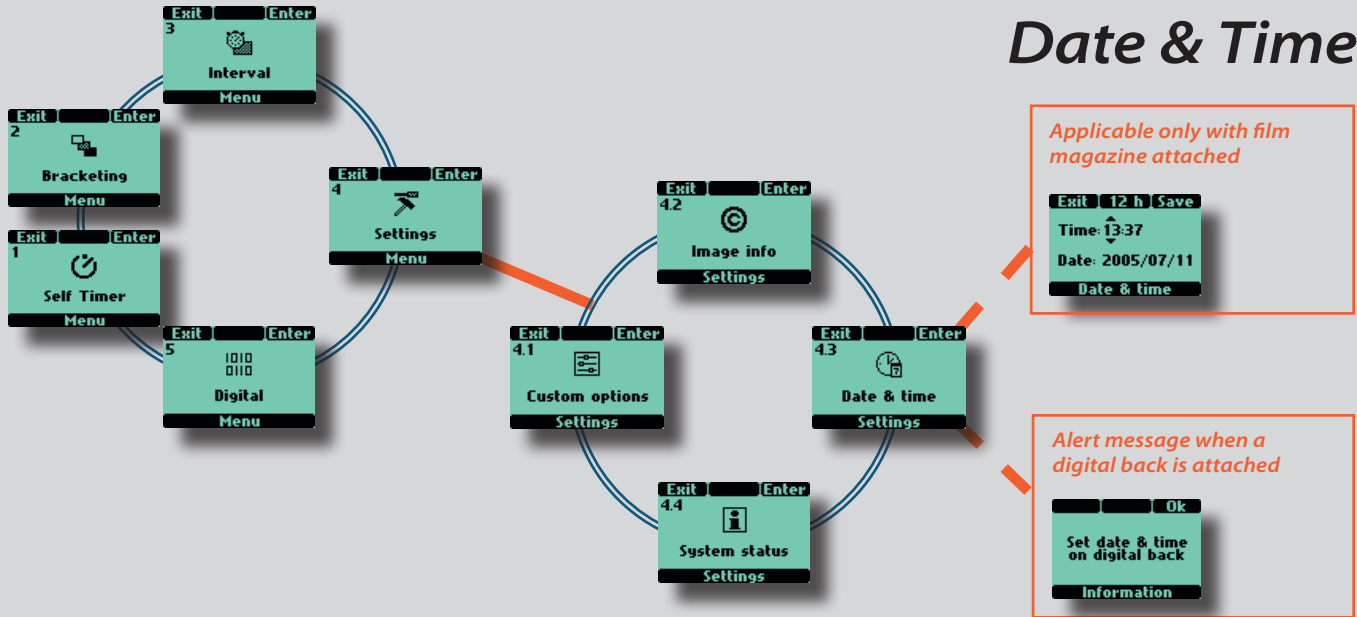

Applicable only with film magazine attached

Exit 12 h Save
Time: 13:37
Date: 2005/07/11
Date & time

Alert message when a digital back is attached

Ok
Set date & time on digital back
Information

4.3 Date & Time

Adjust date and time settings by the following procedure:

- 1) Press the **MENU** button on the grip.
- 2) Turn the front control wheel until **Settings** appears.
- 3) Press the **DRIVE (Enter)** button on the grip.
- 4) Turn the front control wheel to access **Date & Time**.
- 5) Press the **DRIVE (Enter)** button.
- 6) By turning the front control wheel you can move the cursor to mark the following for change: hours, minutes, year, month and day respectively. By pressing the 24 h button (AF), you can choose between a 24 hour or 12 hour system for time.
- 7) Turn the rear control wheel to make the changes when the cursor is correctly positioned.
- 8) Press the **Save (DRIVE)** button to store the new setting.

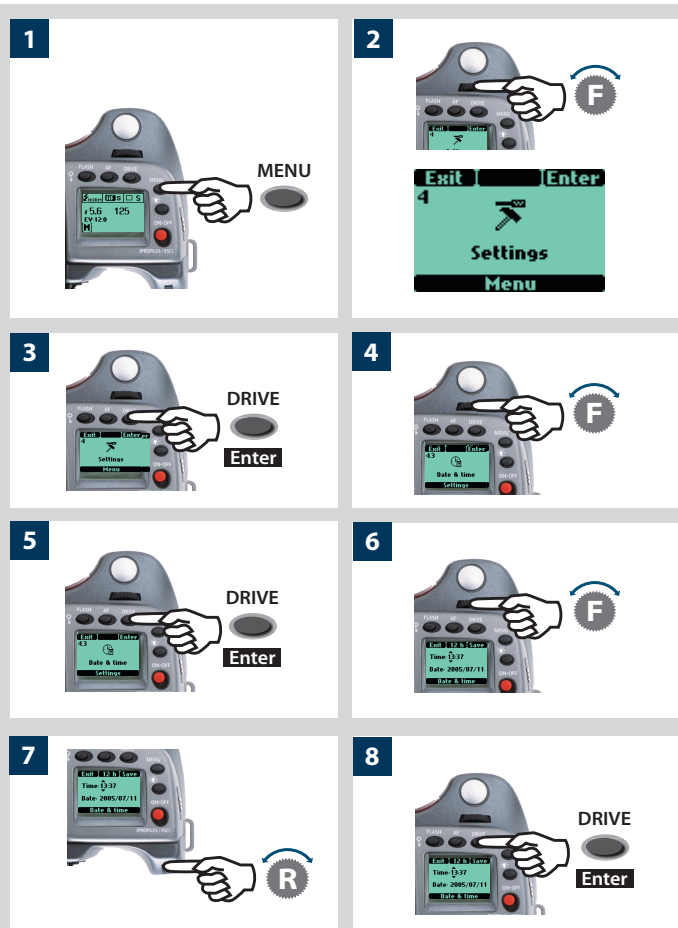

System status

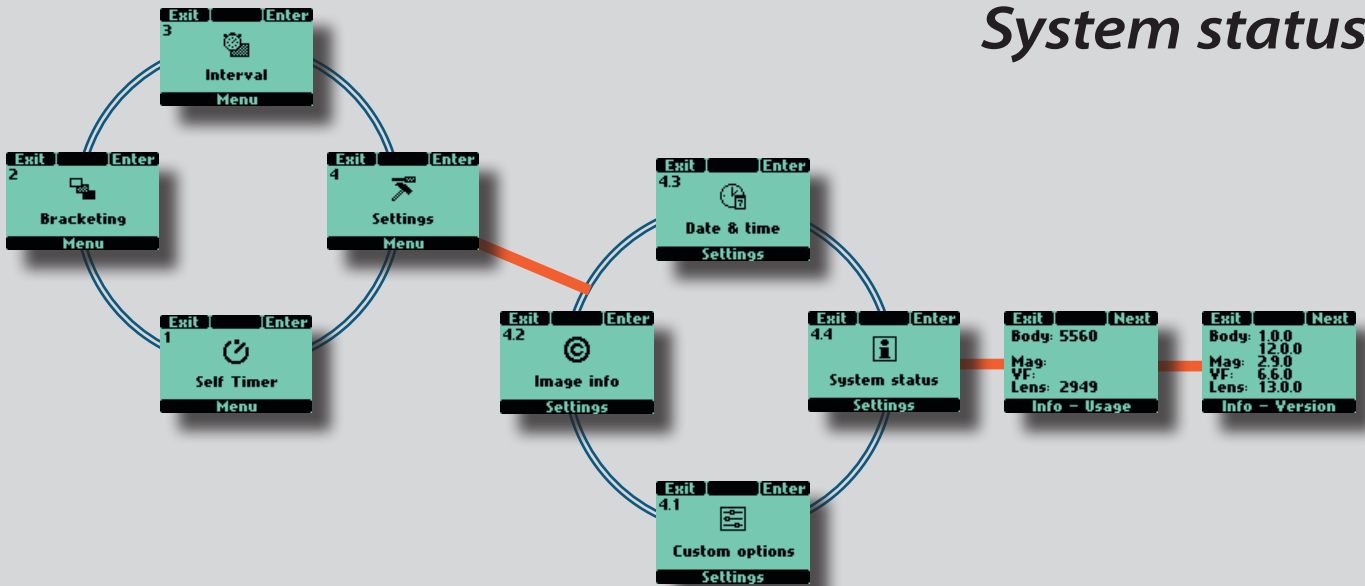

4.4 System status

Check component usage and general servicing information as follows:

- 1) Press the **MENU** button on the grip.
- 2) Turn the front control wheel until **Settings** appears.
- 3) Press the **DRIVE (Enter)** button on the grip.
- 4) Turn the front control wheel to access **Info**.
- 5) Press the **Enter (DRIVE)** button
- 6) Press the **Enter (DRIVE)** button. The display now shows a list of camera components and to the right of each individual component a figure that represents the number of actions taken by that component. Please note that even a completely new camera will have registered actions as these occur during testing before delivery.
- 7) Press the **Next (DRIVE)** button to display the software version for each item.

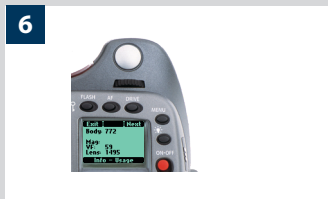
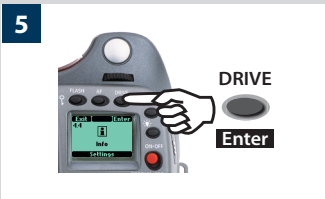
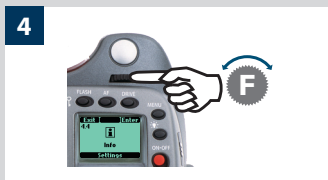
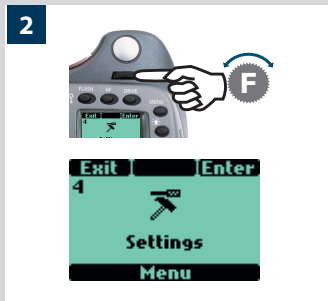

Digital

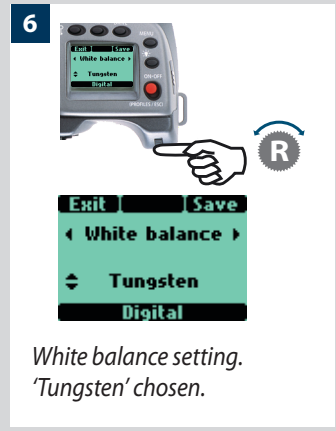
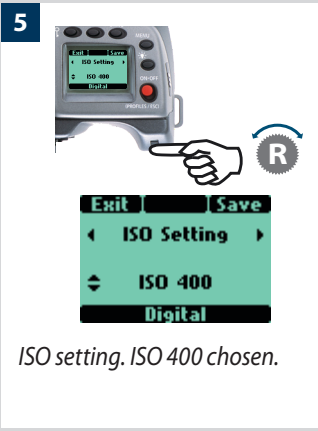
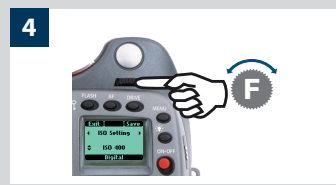
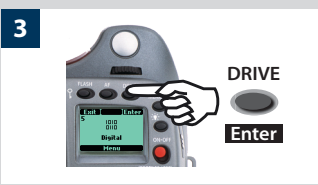
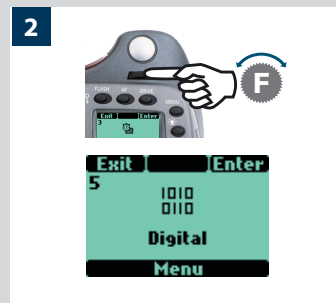
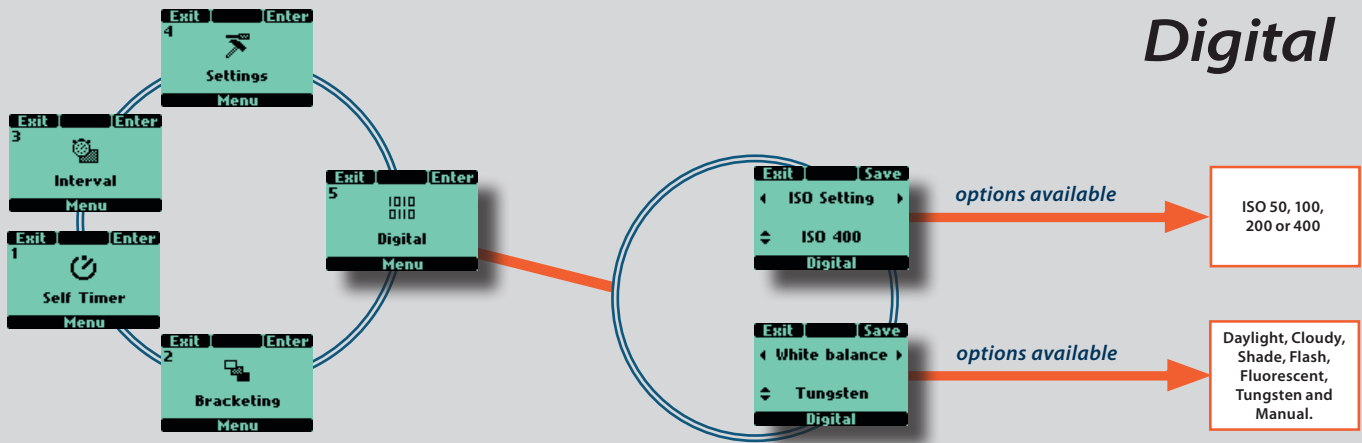

5 Digital

From the Digital screen you can choose between various white balance and ISO settings. These camera settings will override any such settings made on the sensor unit and will show up on the sensor unit screen as new settings.

ISO Setting & White Balance

- 1) Press the **MENU** button on the grip.
- 2) Turn the front control wheel until **Digital** appears.
- 3) Press the **DRIVE (Enter)** button on the grip.
- 4) Turn the front control wheel to access either of the two options, that are:

ISO setting and White Balance

- 5) In **ISO setting**, turn the rear wheel to choose between: 50, 100, 200 or 400.
- 6) In **White Balance**, turn the rear wheel to choose between: Daylight, Cloudy, Shade, Flash, Fluorescent, Tungsten and Manual.
- 7) Press **SAVE (DRIVE button)** to save the setting.

White Balance settings are only approximate color temperature settings. They are only used for user convenience when viewing captures on the sensor unit display. The 3F file is a raw format file and therefore contains all the information required for correction in FlexColor/Phocus and/or other software, regardless of the original color temperature at the time of exposure.

Customizable button function list

- The **USER**, **AE-L**, **STOP DOWN** and **M.UP** buttons can all be reassigned to different functions.
- The **USER** button has no function until specifically assigned one (default is 'None'). The **AE-L**, **STOP DOWN** and **M.UP** buttons, however, by default are assigned the function appropriate to the name, until assigned otherwise.

The buttons can be assigned or reassigned to the following functions:

None

The user button has no function.

Standby

Sets the camera in standby mode to save battery consumption.

Stop down

Stops the lens down.

Flash Measure

Initiates flash measure function.

Interval timer

Initiates interval timer function.

Multi exposure (functions only with film mag.)

Initiates multi exposure function.

Self timer

Initiates self timer function.

Bracketing

Initiates bracketing function.

AE-Lock

Temporarily locks the EV setting in manual and automatic modes.

AF Drive

Activates the AF system in any focusing mode. When the button is pressed the AF system sets the correct focusing point automatically. This is a rapid, accurate and handy way of using the AF system when the camera is set to Manual focus mode. In this manner you take advantage of the accuracy and certainty of the autofocus system while retaining the control inherent in manual focusing mode.

Mirror up

Controls the mirror up or down function (same function as the M-UP button).

B mode

Sets the camera to B exposure mode.

T mode

Sets the camera to T exposure mode.

Cycle LM mode

Changes the light-metering method in a loop manner: Centre Weighted/Average/Spot.

Expose

Functions as shutter release button.

The following do not function when a film magazine is attached.

Histogram

Recalls the last shown histogram on the grip LCD.

Grey balance exp.

Initiates a grey balance exposure using the marker frame to select the desired tone.

Delete last image

Activate the delete function for the last image in a digital back.

Dig. foc check

Displays last exposure taken at 100% scale on digital backs with LCD.

IAA toggle

Allows IAA rating change



A quick way to program the customizable buttons (and to access the Custom Option level in general) is to use the short-cut as follows:

- 1) Press the **MENU** button.
- 2) Then press the **USER** button.

This directly accesses the "**Custom options**" level in the menu where you can access the desired option for a setting change.

Flash

- Sync at all shutter speeds to 1/800s
- Integral fill-flash
- SCA 3002 compatible
- Flash measure capability
- Rear sync capability

The H system meets professional demands for a variety of situations where flash is required.

It includes an integral flash primarily intended for fill-flash use but strong enough for simple close work.

Combined with an adapter and a portable unit, H cameras can exploit the automatic features offered by Metz and other top names in the field for powerful and reliable solutions

When in the studio, the H system is capable of providing flash metering for maximum control and security.



The H2F can be used together with most flash units in manual mode. However, to make use of a TTL automatic function, you must ensure the flash unit is compatible with the SCA 3002 system. Connection is either by the PC socket or by the hot shoe (see warning note below).

The viewfinder houses an integral fill-flash with a guide number of 12 and features OTF/TTL flash control. This unit is capable of providing enough illumination for many fill flash functions outdoors as well as simple indoor shots at shorter distances.

Flash output can be adjusted separately from ambient exposure for optimum control.

Separate flash units can be used in dedicated mode when connected to the hot shoe if the unit is compatible with the SCA3002 (Metz) system using a Hasselblad SCA3902 adapter. This provides a cable free link up for information transfer.

Flash synchronisation can be set to normal or rear (the beginning or end of an exposure).

Please see the relevant user manuals for information regarding separate flash units.

 As with all strobe/studio flash use, very particular attention should be taken to ensure correct connections and general handling practice. Potential dangers might decrease when cameras are connected to strobe/studio flash units by way of IR and similar wireless flash release devices.

Victor Hasselblad AB and Hasselblad A/S can accept no responsibility whatsoever for accidents that might occur or damage caused when Hasselblad equipment is used in combination with third-party units of any description.

 Do not attempt to connect a flash unit dedicated for use with another camera brand via the hot shoe. The flash unit and / or camera could be damaged.

General

When using the A or S setting together with flash, the exposure requirements of the camera will dominate which might produce slow shutter speeds indoors, for example, requiring the use of a tripod. If, on the other hand, you select P or Pv instead, then a shutter speed of 1/60 or faster is automatically chosen by the camera enabling you to hand hold.

When using flash close up or when using larger aperture settings, remember that the flash unit's output has a specific minimum duration which might still be too great for correct exposure. Read the unit's output specifications for further information regarding any potential restrictions.

You can use the flash metering capability with external flash units of all kinds (TTL flashes must be set to Manual mode).

Rear sync is a useful feature used either for effect or to produce a more 'natural' look when combining long exposures involving light trails and flash.

When using suitable dedicated units (compatible with SCA3002), adjustments are made automatically and governed by the settings on the camera. This applies to whether the flash unit is set to TTL or whether it is set to its own integral metering system (A).

Control of either the integral flash unit or separate SCA3002 compatible flash unit regarding the two functions, exposure compensation and shutter sync, is via the grip. The flash measure function can be used for flash units that are not SCA 3002 compatible or for SCA 3002 compatible units at manual setting.

 Only flash units specially adapted for use with the H2F should be connected to the hot shoe on the camera.

To change the balance between flash output and camera exposure requirements to produce a variety of effects, use the exposure compensation function. For various long exposure effects use the sync function. To make flash exposure tests use the flash measure function.

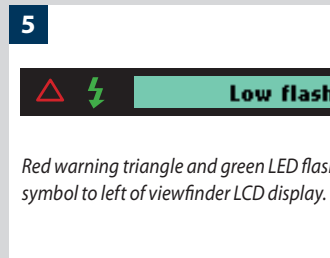
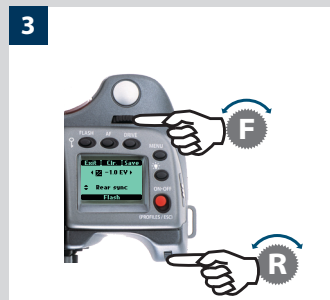
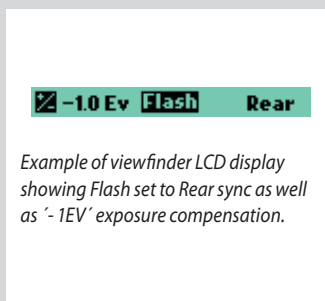
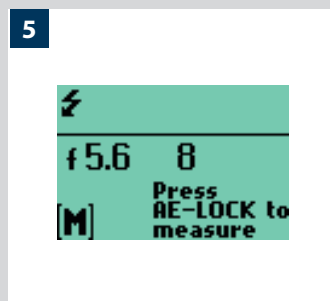
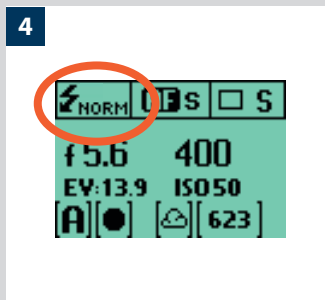

To access the controls:

- 1) Activate the camera and press the **FLASH** button once.
- 2) Turn the front control wheel to set the amount of compensation required:
 - from +3EV through -3EV
 - press **Clr (AF button)** to clear the setting quickly if required.
- 3) Turn the rear control wheel to set:
 - normal sync (flash triggered just after the shutter opens)
 - rear sync (flash triggered just before the shutter closes)
 - flash measure (with non-TTL flash units or TTL units in Manual mode)
- 4) The grip LCD shows the flash mode - Normal or Rear - in the standard display.
- 5) When set to Flash Measure, a specific screen requests you to press the AE-L button in order to make a reading. See below for details.

Integral flash

The integral flash unit features the following specifications:

Guide no.	12
Coverage	56° horizontal, 44° vertical
Maximum light fall-off at side centres	-1EV (50%)
Colour temperature (full flash)	5,000 – 5,600° K

To raise the flash unit into its operative position, slide the flash-unit catch backwards in the direction of the flash symbol. To return the flash unit into its closed position, push down on the top of the unit until it clicks back into place. The flash unit is automatically activated when it is in the operative position and de-activated when returned to its stored position.

The green LED flash symbol blinks in the viewfinder when the flash unit is charging and remains stationary when fully charged. The flash output can also be adjusted for optimum light balance in fill-flash situations.

Do not use the integral flash together when another external TTL flash unit is connected (and used in TTL or A mode)

For full coverage with the integral flash, use 80 mm or longer lenses (without a lens shade).

Using the integral flash:

- 1) Slide the flash-unit catch backwards in the direction of the flash symbol.
- 2) Press the **FLASH** button.
- 3) Choose between **Normal** or **Rear** sync by turning the rear control wheel and the amount of compensation (if required) by turning the front control wheel.
- 4) Press **Save (Drive)** button. Make an exposure.

- 5) If the settings were incorrect to match the output of the flash unit, the viewfinder LCD displays a red triangle alongside a flashing green 'flash' symbol plus a warning message - '**Low flash**'. The grip LCD will also display a warning message - '**Low flash**'.

Conventional measures should then be taken to correct the situation. (That is: move closer to the main subject, use a larger aperture setting or use a higher ISO setting).

 The 'Low Flash' warning can be turned off in Custom Option #26 if preferred.

Separate flash unit connection and use

Separate flash units can be electrically connected either by way of the hot shoe accessory holder (see previous warnings) on the top of the viewfinder or via a cord to the PC connection port on the left hand side of the camera body. Slave unit switches/ transmitters can also be connected similarly dependant on unit (see specific user manuals for details).

Keep the plastic safety cover in place in the hot shoe when not in use.

Flash measure of separate flash unit

You can measure the effect of an attached flash unit (with PC connected flash units and SCA3902 compatible flash units set to M mode), where the camera acts much as a flash meter would. The aperture setting can be adjusted and more trial exposures made until the information on the grip LCD is satisfactory.

To use flash measure:

- 1) Press the **FLASH** button on the grip to access the flash option screen.
- 2) Turn the rear control wheel until **Flash measure** appears.
- 3) Press **Save (DRIVE)** button to access the flash exposure screen.
- 4) Make preliminary required aperture setting by turning the front control wheel.
- 5) Press the **AE-L** button. The camera will close the aperture, raise the mirror and fire the flash. Light reflected from the flash lit subject will be reflected off a white spot on the auxiliary shutter to the meter sensor.
- 6) Deviations from a normal exposure are displayed as differences in EV on the grip LCD and the viewfinder LCD. If '**high**' or '**low**' appears, change the aperture accordingly and make a new test reading.

Change the aperture until **Diff EV: 0** appears, or the desired amount of deviation from the normal exposure.

Diff EV: Low signifies more than 2 EV under

Diff EV: High signifies more than 2 EV over

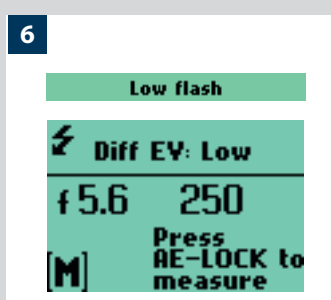
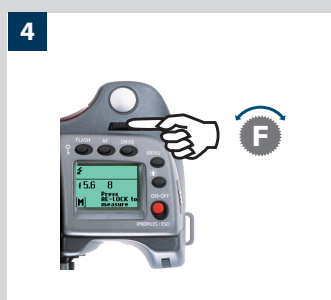

11

Optional Accessories

- Converter
- Extension tubes
- Release cord
- Filters
- Tripod quick coupling
- Support strap
- Camera strap
- Focusing screens
- CF adapter
- Proshade
- Flash adapter
- HVD 90x viewfinder
- HVM waist level viewfinder
- HMi 100

Optional accessories provide the opportunity to extend the capabilities of your system or just to add extra convenience to suit your way of working.

(The figures in brackets after the headings are the product codes.)

H2F



Converter H 1.7X

(3023717)

The Converter attaches between the lens and the body to increase the focal length by a factor of 1.7. This provides a convenient way to expand your range of lenses. The Converter H 1.7 X features the same outstanding optical and mechanical quality as all the lenses in the Hasselblad H system. The optical design consists of 6 elements in 4 groups.



UV-sky filters

(3053470, 3053474 and 3053478)

Absorbs UV radiation and reduces blue haze without affecting colours. Also protects the front lens surface. Particularly recommended when the camera is used in harsh conditions. Available in three sizes to suit various lenses: UV-sky 67 mm (3053470), UV-sky 77 mm (3053474) and UV-sky 95 mm (3053478).



H 13, 26 and 52 Extension tubes

(3053513, 3053526 and 3053542)

The Extension tubes attach between the lens and the body to reduce the close focusing distance for close up photography. They are available in three sizes: 13mm, 26mm and 52 mm. As the H2F has a TTL light metering system, exposure compensation is automatic.



Pola filters

(3053482, 3053486 and 3053490)

Reduces non-specular reflections and glare. Increases colour saturation in general. Can intensify a blue sky. Available in three sizes.



Tripod quick coupling H

(3043326)

Mounted on a tripod, this accessory facilitates rapid attachment and removal of the camera. The camera is firmly held in an exact and repeatable position. Two integrated spirit levels make horizontal positioning of the camera easy. The Tripod quick-coupling H fits 1/4" and 3/8" tripod threads and has a safety catch.



Release cord H

(3043370)

Remote release cord with a cable length of 0.5 m.



Support strap H

(3053623)

Improves comfort and security with hand-held photography.



Camera strap H

(3053616)

Extra wide camera strap with anti-slip backing.

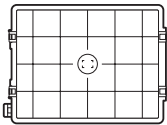

Focusing screen HS-grid

(3043310)

Spherical Acute-Matte D type with grid and central markings for spot (\varnothing 7.5 mm) and AF metering area. Grid provides aid in technical, architectural, and other detail photography.



CF Adapter

(3043500)

The CF adapter allows virtually all lenses from the V-system to be used on H-system camera bodies. This automatically expands the potential lens range for H cameras by more than a dozen different focal lengths.



Proshade V/H 60 - 95

(3040740)

An adjustable bellows lens shade that provides highly efficient protection against stray light. Its compact, flat folding design saves space in the equipment case. With adapters fits all HC lenses and virtually all V system lenses. Also features a filter holder for glass, gelatin, or plastic filters.



Proshade adapters

(3043415, 3043417, 3043419)

67 mm, 77 mm and 95 mm adapters with bayonet mount for HC lenses. Features lock to provide positive and secure attachment.



Flash adapter SCA 3902

(3053393)

For connecting flashes compatible with the SCA 3002 system to the Hasselblad H2F.



HVM waist level viewfinder

(3053328)

The HVM waist level viewfinder allows a comfortable lower viewing angle either for effect or where eye contact with the subject is desirable in portrait photography, for example. Autofocus function of all lenses fully retained. Optimized for horizontal format shooting and not suitable for vertical format use.



HVD 90x viewfinder

(3053330)

This viewfinder is specifically designed for digital photography to provide a field of view that matches the sensor format. Image magnification 3.1x. Built-in diopter adjustment from -5 to +3.5D. Otherwise very similar specifications to the HVD90.



HMi 100

(3033100)

A film magazine for 100 instant film. Extremely useful for quickly checking exposure, lighting and composition when working with a film back.

Check on the Hasselblad website – www.hasselblad.com – for further details or news of new accessories.

HC /HCD lens range

 This lens compatible with digital back only.



HCD 4/28 mm



HC 3.5/35 mm



HC 2.2/100 mm



HC 4/210 mm



HC 3.5/50 mm



HC Macro 4/120 mm



HC 4.5/300 mm



HC 2.8/80 mm



HC 3.2/150 mm



HC 3.5-4.5/50-110 mm



HC 1.7X converter



V system C type lenses with optional CF lens adapter

Appendix

- Glossary of Terms
- P and Pv explanatory charts
- Technical specifications
- Equipment Care, Service & Guarantee

This section provides an insight into the more technical aspects of the H system as well as some important reference information.

Glossary of Terms

For the sake of clarity, here are short and simple explanations of several terms, items and features mentioned in the manual that may be unfamiliar to some.

Bracketing

The practice of making extra exposures over or under (normally both) the 'standard' exposure to ensure the desired result. This is particularly useful in difficult, wide-ranging lighting conditions. Easily set and controlled with the H2F.

Custom setting

The setting chosen by the user that differs from the default setting.

Click / Press – On.Off button

The ON.OFF button can be depressed in two different ways which in turn cause different results. This distinction is referred to in the text as *clicking* and *pressing*. *Clicking* is a very rapid depressing of the button with immediate release whereas *pressing* is a longer depression of the button with maintained pressure.

EV

Exposure Value. It represents the standard photographic notation within exposure control. For example, if you change the aperture on a lens from f/11 to f/8, you will increase the exposure by 1EV. Similarly, if you change the shutter speed from 1/15s to 1/60s you will decrease the exposure by 2EV. A change in EV can therefore represent a change in aperture, shutter speed or a mixture of both. It is a simpler and more useful way of referring to the essential effective combination when making exposure settings without referring to the implications and sometimes confusing aspects of specific shutter speeds or apertures.

As a practical example, if you are using 'exposure compensation', the settings are in EV's (often referred to as 'stops' in older descriptions) or fractions of EVs (or 'stops'). Therefore an exposure compensation of +1EV, for example, will provide 'one stop over-exposure' and similarly an exposure compensation of -1/2EV, for example, will provide 'a half stop underexposure'.

See the chart in this manual for cross reference of EVs and their aperture/shutter speed equivalents

Default setting / factory setting

A standard setting that a device is set to in the first instance during manufacture and returns to if a setting change is halted or interrupted in any way.

Half-press / Full press – Shutter release button

The shutter release button can be depressed in two different ways. This distinction is referred to in the text as *half-press* and *full-press* positions. A *half-press* is a rapid, soft press whereas a *full-press* is a firmer and longer depression of the button.

LCD

Liquid Crystal Display. An electronic information panel. The grip and magazine both have LCD panels.

LED

Light Emitting Diode. Electronic devices used in information displays. The viewfinder display has LED's to the left and right of the integral LCD panel.

Mid-grey / 18% grey

An important point to be remembered is that all photographic exposure meters / light metering systems are calibrated to provide a reading that will reproduce a 'mid-grey or 18% grey tone' from the measured subject tone. This is an international photographic standard upon which all exposure calculations must be based. The H2F has very accurate and sophisticated exposure measuring modes. Pre-programmed information is taken into account via the metering system when calculations are automatically made. This provides a very satisfactory compromise for a host of photographic situations and many users will certainly be very satisfied with the consistently high quality of results. Nevertheless, some situations are either so technically difficult or open to interpretation that manual intervention is advised to ensure the desired result. Naturally, many seasoned users always prefer manual control but they base their calculations and decisions on much experience.

To illustrate this point, imagine the following example:

Pin two sheets of paper, one black and the other white, onto a grey wall. Take three exposures using an average light reading; a close-up of the black sheet, a close-up of the white sheet, and a distance shot of the whole wall including the two sheets. Without any manipulation, the first two exposures will produce a tone that is similar to the wall, namely, a grey tone; not black or white. The third exposure, however, will reproduce the wall as a grey tone while the two respective sheets now appear as black and white respectively, as originally observed.

However confusing this might at first seem, it is fundamental to mastering exposure calculations and exposure control. If you are at all unsure about this basic concept, you are strongly recommended to refer to a general photographic manual for a fuller explanation in order to obtain the maximum from your H2F.

OTF

Off The Film - the literal description of the light measurement mechanics regarding flash exposure measurement.

Main screen

To simplify the descriptions, reference is often made to a 'main' screen regarding the menu. Apart from default settings, there is no standard setting in the normal sense and therefore you create your own 'standard', which of course can be changed at any time.

The 'main' screen is therefore the one you have currently created and is the one visible on the LCD when photographing (except where a particular mode is in actual operation, such as self-timer, for example).

Profile

You can allow the H2F to be set according to 'profiles'. These profiles are combinations of modes, methods and settings (custom or default) that suit specific photographic situations. By using a personal profile - which you can create, name and save - the camera is immediately configured for a specific purpose without any need to check through the menus. This is a very rapid and secure way of working when repeatedly confronted with similar photographic situations.

As an example you might regularly take outdoor portraits of wedding couples with a long lens. You want a specific aperture to restrict depth-of-field and a fairly fast shutter speed to freeze any movement. You are concerned about the couple blinking during the exposure and so want to take several shots in succession, possibly with slight variations in exposure settings for safety's sake so you might choose the bracketing option too. All these parameters can be preset and stored as a profile that is rapidly accessible.

Quick save

When altering settings, a half-press of the shutter release button will cause a return to the main screen and save the new setting at the same time.

Standard exposure

A 'standard exposure' in the manual refers to the concept of technically correct in accordance with internationally accepted photographic measurement standards (see section on Mid-grey / 18% grey). This does not imply, however, that it would automatically be the preferred choice or be 'correct' according to the desired result. See section on Bracketing.

TTL

Through The Lens - a literal description of the light measurement mechanics. The advantage is that only the essential parts of the subject in front of the camera are included. Accessories such as filters, bellows, close-up rings, converters, etc that could affect exposure are also taken into account automatically with exposure evaluation (for general purposes).

Time out

This is the time interval that a temporary setting is maintained for before it automatically returns to the original setting (default or custom).

Zone (system)

The Zone System is a method of combined exposure calculation/film development providing a great deal of tonal control. It was originally devised by Ansel Adams - the classic landscape photographer and Hasselblad user - and now exists in various forms for both black & white and colour photography.

Naturally in the case of the H2F or any other digital camera, the film development part of the method can not apply. However, some photographers are used to its philosophy and are familiar with its terminology and might like to still refer to it.

An integral part of the method includes the classification and grouping of any given scene into a range of nine (or ten) so-called zones, hence the name. Concerning the H2F, the word zone refers to the grouping and classification of various tones, where Zone V is the equivalent (whether in black & white or colour) to 18% mid-grey on a scale of Zone I (black) through Zone IX (white). See specific literature for a complete description of this method.

True exposure

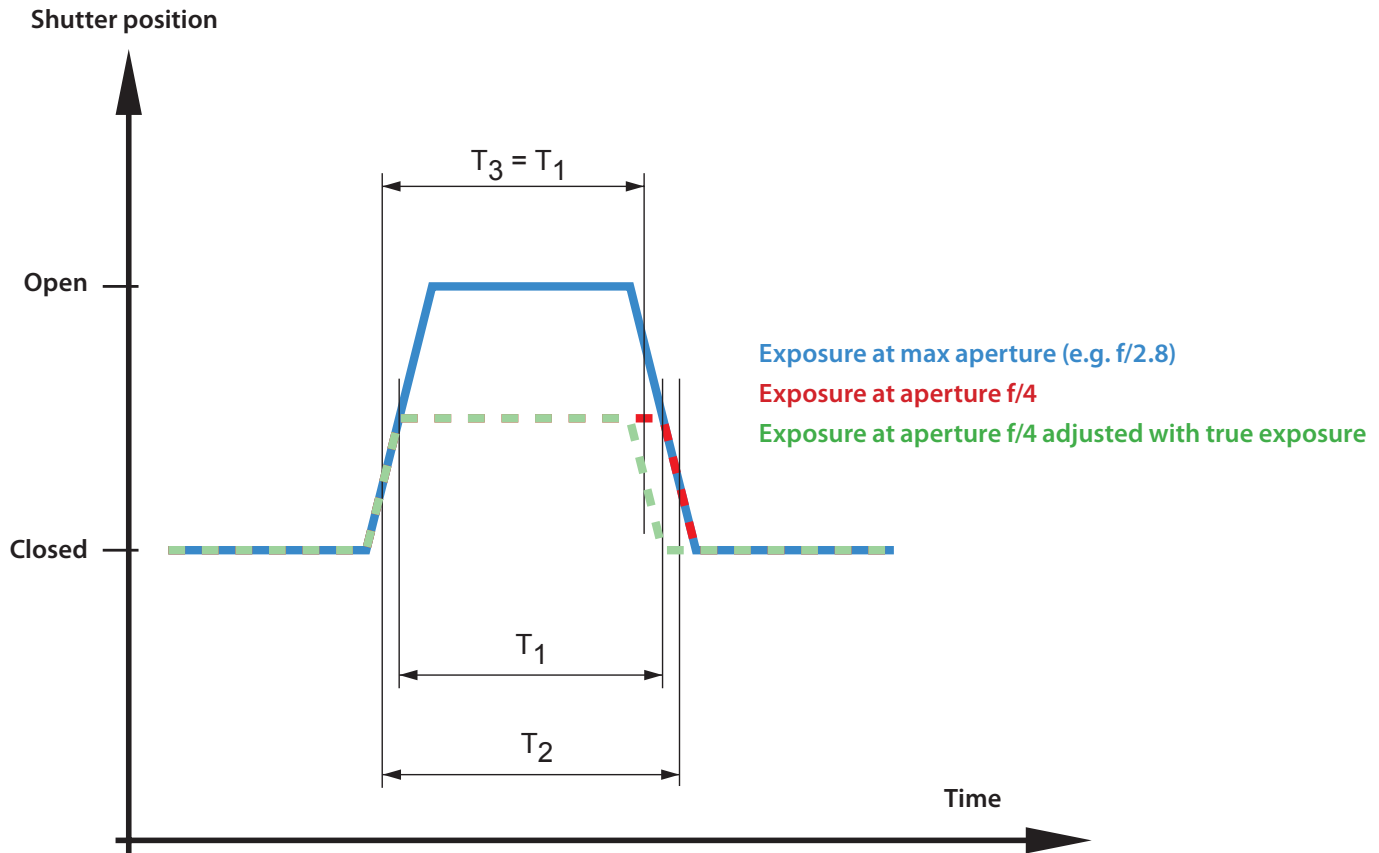

True exposure

The effective shutter speed for a central lens shutter is defined as the length of time between the opening and closing when measured at the half height position when expressed in diagram form (see diagram). The fact that it will take some time to open and close the shutter will have an influence on the effective shutter speed as the lens aperture closes to its setting. The faster the shutter opens and closes, the less this influence will be. It also follows that the influence will be greater on shorter shutter speeds.

With the lens at full aperture (largest opening), the amount of light at the film plane appears as illustrated by the blue curve in the diagram. The effective shutter speed then becomes T_1 . If the lens is now closed down by one stop, the amount of light appears as illustrated by the red dashed curve. The effective shutter speed is now increased to T_2 , which is longer than T_1 . The result is that the exposure is not reduced by exactly one stop (1EV), however, but slightly less. At the shorter shutter speeds, the exposure error can be as much as 0,5 – 0,8 EV.

The True exposure mode can compensate for this exposure error since the behaviour of the shutter is a known and predictable factor. At shutter speeds of 1/150 second or shorter (faster), the camera will shorten the shutter speed to compensate, as illustrated by the green dashed curve. At the fastest shutter speeds, however, it is not possible to adjust the shutter speed and so the aperture is adjusted instead.

Although it is probably an infrequently used combination, please note nevertheless that the fastest shutter speed / minimum aperture combination cannot be adjusted by True exposure.

Automatic exposure – P & Pv Mode

P Mode

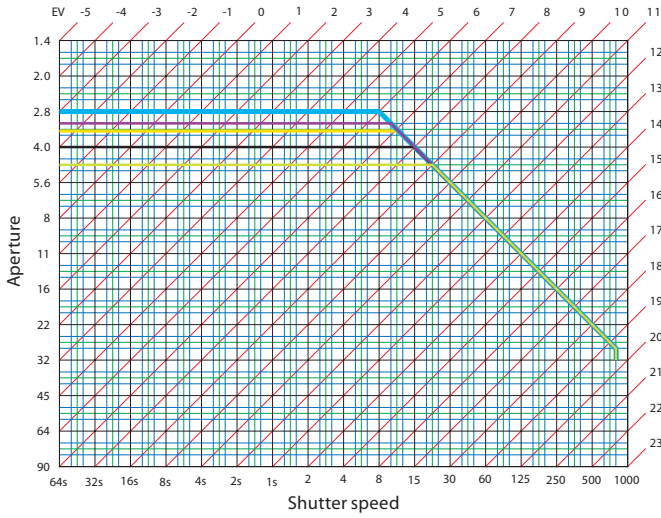

Pv Mode

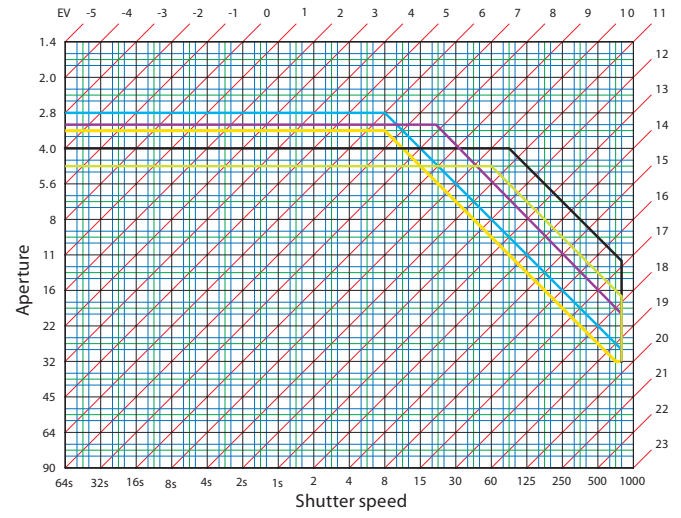

Light metering method sensitivity distribution – HV90X

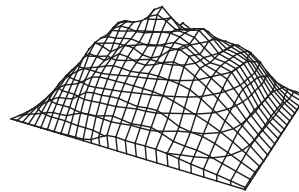
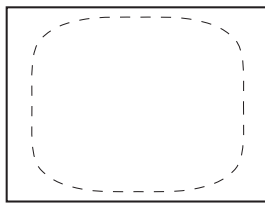
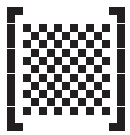

Average
(45 x 37 mm)
≈ 70%

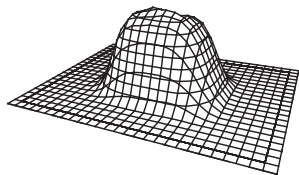
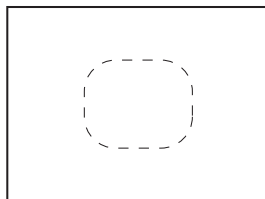

Centre weighted
(23 x 20 mm)
≈ 20%

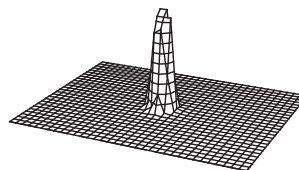
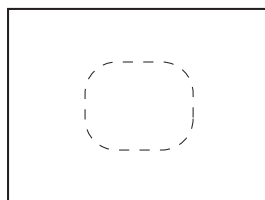
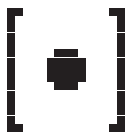

Spot
(diameter 7.5 mm)
≈ 2%

Technical specifications

Camera type	Auto-focus, auto-exposure SLR camera with interchangeable magazines, viewfinders and lenses.
Construction	One piece stainless steel shell. Die-cast aluminium internal structure. Tripod sockets (1/4 and 3/8") and quick coupling tripod plate for rapid mounting.
Lenses	Hasselblad HC lenses with built-in electronically controlled shutter and aperture. Automatic or manual focusing with instant manual focus override. Lens shades can be mounted in reverse for transport.
Viewfinders	A 90° reflex viewfinder, providing 100% field of view even when wearing eyeglasses, and built-in multi-mode light metering system. Image magnification 2.7. Integrated fill-in flash with guide number 12. Hot-shoe for automatic flash (Metz SCA3002 system / adapter SCA3902). Dot matrix LCD with presentation of all relevant information. Built-in diopter adjustment from -4 to +2.5D.
Focusing	Automatic and manual focusing with electronic focus aid in manual mode. Instant manual focus override. Automatic focusing using passive central cross type phase detection sensor. AF metering range EV 1 to 19 (ISO 100).
Data imprinting	Data is imprinted outside the image area. The user can specify which data is to be imprinted. Data can include any text the user desires, such as exposure data, time and date, the photographer's name, copyright symbols, etc.
Film transport	Automatic film advance at approx. 2 frames per second. Multi-exposure capability. Drive modes: single and continuous.
Film format	6 x 4.5 cm (actual size 55 x 41.5 mm).
Film choice	120 and 220 roll film.
Shutter	Electronically controlled lens shutter with speeds ranging from 18 hours to 1/800 of a second including B- and T-mode.
Flash control	TTL centre-weighted system. Can be used with the built-in flash or a wide variety of flashes compatible with the SCA3002 (Metz) system using adapter SCA3902. Film speed range ISO16 to 6400. Flash output can be adjusted for fill-in purposes independent of ambient light.
Flash measurement	The H2F has a built-in measurement system that measures flash light from non-TTL flashes, such as studio flashes.
Film backs	Interchangeable film backs with film insert for both 120 and 220 film types. Automatic film length setting. Built-in curtain type, dark slide. Automatic wind to frame one and wind off. Multi-mode data imprinting outside image area. Features Barcode recognition.
Exposure metering	Multi-mode exposure metering using 90° reflex viewfinder. Metering options are: spot (diameter 7.5 mm), centre weighted, and average. Metering range at f/2.8 and ISO100: Spot: EV2 to 21. Centre-weighted: EV1 to 21 Average: EV1 to 21.

Auto bracketing	Bracketing using predetermined number of exposures (2, 3, 5, 7 or 9) in 1/3, 1/2, or 1 EV step difference intervals.																
Interval timer	Number of frames from 2 to 32 and interval from 1 second to 1 hour.																
Film speed	Film speed range ISO 6 to 6400. Automatic setting with Barcode film.																
Displays	The camera features two dot-matrix LCD's that provide clear and easy-to-understand information to the user. One is located on the grip and the other in the 90° viewfinder. The magazine has a segment based LCD.																
Focusing screen	Bright Spherical Acute-Matte type D. Optional type with grid markings also available.																
Accessory connection	Provided with two M5 threads and an electrical connector for accessories.																
Customization	A large number of the H2F's functions can be customized by the photographer to suit specific styles or situations through the built-in menu system.																
User interface	Both basic and advanced functions are set using buttons and control wheels on the camera body in conjunction with the graphic interfaces.																
Power supply	A cassette for 3 CR-123 Lithium type batteries. Optional cassette with fixed rechargeable batteries.																
Battery grip rechargeable 7.2 V	Li-ion type. 7.2 V / 1850 mAh output.																
Battery charger Li-ion 7.2 VDC	Uses DV charge termination technique to prevent over-charging. 100–240 VAC / 50–60 Hz input. 6.0–7.9 VDC / 800mA output																
External dimensions	<p><i>All external dimensions are approximate and include fitted protective caps and covers.</i></p> <table border="0"> <tr> <td>H2F Camera body:</td> <td>89 x 155 x 117 mm (L,W,H):</td> <td>3.5 x 6.1 x 4.6 ins.</td> </tr> <tr> <td>HV 90X Viewfinder:</td> <td>140 x 78.5 x 52 x mm (L,W,H):</td> <td>5.5 x 3.1 x 2.0 ins.</td> </tr> <tr> <td>HM 16-32 Film magazine:</td> <td>64 x 98 x 84 mm (L,W,H):</td> <td>2.5 x 3.9 x 3.3 ins.</td> </tr> <tr> <td>HC 2.8/80mm lens:</td> <td>85 x 84 mm (L,W)</td> <td></td> </tr> <tr> <td></td> <td>(width 89 mm with lens shade mounted in reverse):</td> <td>3.3 x 3.3 ins.</td> </tr> </table>	H2F Camera body:	89 x 155 x 117 mm (L,W,H):	3.5 x 6.1 x 4.6 ins.	HV 90X Viewfinder:	140 x 78.5 x 52 x mm (L,W,H):	5.5 x 3.1 x 2.0 ins.	HM 16-32 Film magazine:	64 x 98 x 84 mm (L,W,H):	2.5 x 3.9 x 3.3 ins.	HC 2.8/80mm lens:	85 x 84 mm (L,W)			(width 89 mm with lens shade mounted in reverse):	3.3 x 3.3 ins.	
H2F Camera body:	89 x 155 x 117 mm (L,W,H):	3.5 x 6.1 x 4.6 ins.															
HV 90X Viewfinder:	140 x 78.5 x 52 x mm (L,W,H):	5.5 x 3.1 x 2.0 ins.															
HM 16-32 Film magazine:	64 x 98 x 84 mm (L,W,H):	2.5 x 3.9 x 3.3 ins.															
HC 2.8/80mm lens:	85 x 84 mm (L,W)																
	(width 89 mm with lens shade mounted in reverse):	3.3 x 3.3 ins.															
Weight	<p><i>All weights are approximate and include fitted protective caps and covers, batteries and film.</i></p> <table border="0"> <tr> <td>H2F Camera body:</td> <td>820 g</td> <td>–</td> <td>28.9 oz.</td> </tr> <tr> <td>HM 16-32 film magazine:</td> <td>475 g</td> <td>–</td> <td>16.7 oz.</td> </tr> <tr> <td>HV 90X Viewfinder:</td> <td>325 g</td> <td>–</td> <td>11.5 oz.</td> </tr> <tr> <td>HC 2.8/80mm lens:</td> <td>500 g</td> <td>–</td> <td>17.7 oz.</td> </tr> </table>	H2F Camera body:	820 g	–	28.9 oz.	HM 16-32 film magazine:	475 g	–	16.7 oz.	HV 90X Viewfinder:	325 g	–	11.5 oz.	HC 2.8/80mm lens:	500 g	–	17.7 oz.
H2F Camera body:	820 g	–	28.9 oz.														
HM 16-32 film magazine:	475 g	–	16.7 oz.														
HV 90X Viewfinder:	325 g	–	11.5 oz.														
HC 2.8/80mm lens:	500 g	–	17.7 oz.														

External dimensions

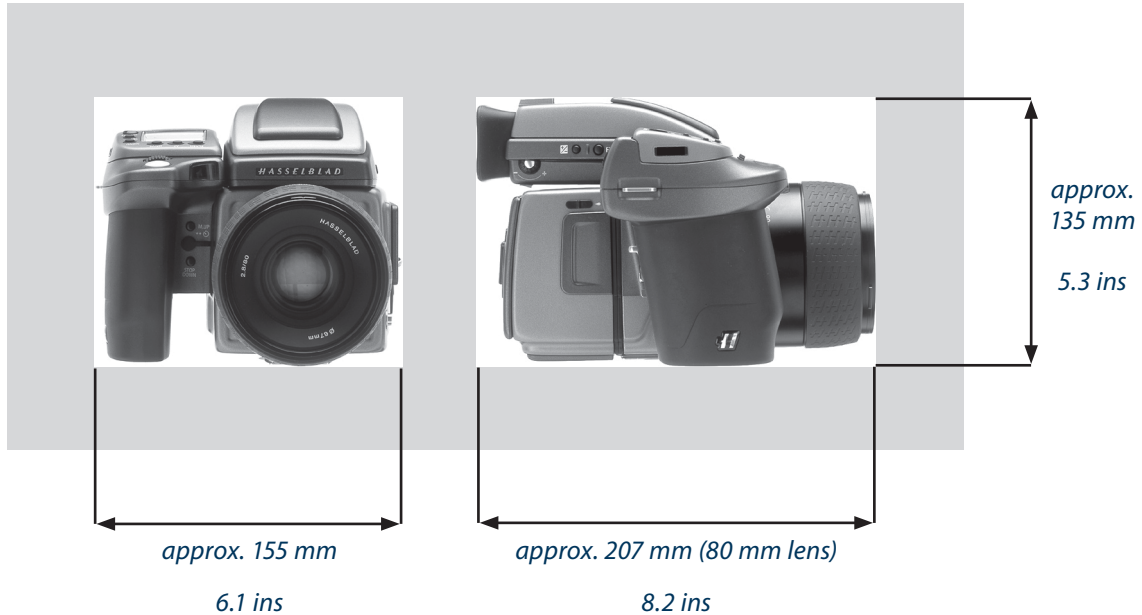

H2F Data imprinting modes

Type 1	Enhanced exposure information	Aperture Shutter speed Light metering mode Exposure mode Exposure adjustment Flash symbol Flash exp. adjustment Focus mode Frame number Focal length	(Not printed if value = 0) (If flash is used) (Not printed if value = 0)	
Type 2	Basic exposure information	Aperture Shutter speed Exposure adjustment	(Not printed if value = 0)	
Type 3	Date & Time	Date Time	format: yy mm dd format: hh:mm:ss format: hh:mm am / pm	24 hour mode 12 hour mode
Type 4	Text & Date	User defined text Date	max 37 chars	Not printed if text is longer than 33 characters
Type 5	Text & Info	User defined text Aperture Shutter speed Exposure adjustment	max 37 chars (Not printed if value = 0)	Not printed if text is longer than 33 characters Not printed if text is longer than 33 characters Not printed if text is longer than 33 characters
Type 6	Text	User defined text	max 37 characters	

BODY*Default setting (Standard Profile)*

Exp.mode		A (Aperture priority)	
LM mode		Centre weighted	
Exp. adjust		0	
Focus mode		AF-S	
Drive mode		S	
Flash sync		Normal (beginning of exp.)	
Flash adjust		0	
Self timer	delay	10 sec	
	Sequence	Mirror up / Delay	
	Mirror mode	Mirror lowered	
Bracketing	Frames	3	
	Sequence	Normal - over - under	
	EV diff	0,5 EV	
Interval timer	Frames	3	
	Interval	0 min 30 sec	
Custom options	1	Standby timeout	10 sec
	2	EV increment	1/2 step (0.5 EV)
	3	Exp adjust increment	1/3 step (0.3 EV)
	4	User button function	None
	5	AE-Lock button function	AE-lock
	6	Stop Down button function	Stop down
	7	M.UP button function	Mirror up
	8	Control wheel direction	CW
	9	Flash ready exposure lock	Yes
	10	Magazine exposure lock	Yes
	11	Lens exposure lock	Yes
	12	Out of range exposure lock	No
	13	True exposure	On
	14	Spot mode	Normal
	15	Focus aid in MF	Half press
	16	AF assist light	Ext. Flash
	17	Rear wheel quick adjust	Yes
	18	Control lock	All controls
	19	Film wind on	Half press
	20	Beeper	On
	21	Show histogram	Yes
	22	Interval & Selftimer	Exit
	23	AE-lock & Quick adjust	Exp. reset
	24	Show EV	Yes
	25	Show ISO	Yes
	26	Bracket param. in Manual	Shutter speed
	27	Aperture control in Manual	Front wheel
	28	Low flash warning	On
	29	Interval timer initial delay	None
	30	Aperture indicator	Normal
	31	Extra mirror-delay	50ms
	32	ISO /WB Menu	Menu
Imprint	type	Enhanced exposure information	
	text		

**FILM
MAGAZINE***Default setting*

Film speed	Bar code setting
Film length	120 film, 16 frames
Data imprinting	On
Frame counter	Count up (Remain Off)

Problems, Equipment Care & Service

The H2F is a very sophisticated camera that relies on much information being passed and processed to and from each modular unit to produce the correct behaviour. It is therefore essential that reasonable care is taken in attaching, detaching and storing the viewfinder, lenses, extension tubes, magazines etc to ensure that the databus connections are not damaged or soiled in any way. Also when lifting or handling the camera try to always use the grip or strap and avoid holding the camera just by the magazine or viewfinder. Warning messages, for example 'The darkslide is closed' are easily addressed and remedied but 'Error' messages seen on the grip LCD require further attention as they denote a fault, temporary or otherwise. You should methodically investigate the situation to see for example whether the recent attachment of an accessory has coincided with the appearance of an error message. Standard procedure is to detach and re-attach the viewfinder, magazine etc ensuring that they are positioned firmly and correctly to see whether the problem disappears. Failing that, removal of the batteries or battery pack for about ten seconds or so will reset the camera's processors. Persistent error messages might well signify a more complex problem and you are advised to contact your nearest Hasselblad Authorized Service Center for advice. As well as the error message, a description of the camera's behaviour and an account of what action you were trying to take when it happened could be beneficial. Also, please remember that the Center will almost certainly want to inspect all of the items that were involved when the error message first appeared, not just the camera body.

In certain situations, it is possible that the camera can be affected by a discharge of static electricity particularly if the area around the control buttons on the grip comes into contact with a conductive cord or material that is connected to earth, directly or indirectly (a lighting stand, for example). This might temporarily deactivate the camera though it does not cause any damage. Press the red ON.OFF button on the grip again to reactivate the camera.

If a problem does occur you are advised not to attempt any repairs yourself. Some service operations require very sophisticated instruments to check, measure and adjust and there is a real danger of creating more problems than solving them if such attempts are made in any other way.

EQUIPMENT CARE

A Hasselblad camera is designed to withstand the rigours of professional use in most environments. To avoid the possibility of damage however, it should be protected from harsh conditions and in particular avoid oil fumes, steam, humid conditions and dust.

Extremes of temperature: High temperatures can have an adverse effect on both film and equipment. Try to avoid frequent and severe temperature changes. Be particularly careful in humid environments. Allow the equipment to acclimatize before assembly. Try to ensure the storage conditions in such environments are as dry as possible.

Dust and grit: Take care to prevent dust and grit from getting into your equipment. In coastal areas take measures to protect your equipment from sand and salt water spray. Dust on the lens glass and focusing screen can be removed with a blower brush or very soft lens brush if necessary. Smears on the lens glass should be treated with great caution. In some cases they may be removed with a high quality lens cleaning solution on a tissue but be careful not to scratch

the lens or touch any of the glass surfaces with your fingers. If in any doubt, do not attempt to clean lens glass surfaces yourself but allow a "Hasselblad Authorized Service Center" to treat them.

Impact: Your equipment can be damaged by severe physical shocks so practical protective precautions should be taken. Some form of protective case or camera bag is advised for transportation.

Loss: Hasselblad equipment is much sought after and you should take obvious steps to prevent theft. Never leave it visible in an unattended car, for example. Separate and specific camera insurance cover should be considered by professional users.

SERVICE

Return your equipment to a service centre for occasional checking and preventive maintenance to ensure optimal reliability. You can easily keep a check on service intervals by looking under 'Info' in the menu. If your camera is used constantly and intensively, regular periodic check-ups are recommended at one of the "Hasselblad Authorized Service Centers". They have the expert staff and specialised equipment necessary to ensure that your equipment remains in perfect working order.

CAUTION

- Keep all equipment and accessories out of the reach of small children.
- Do not place heavy objects on the equipment.
- Do not use the batteries except as specified.
- Use only the batteries specified for use with the camera.
- Remove the batteries when cleaning the camera or if you intend to leave the camera unused for a long period.
- If you use spare (standard or rechargeable) battery packs be particularly careful to use the supplied protective cap when storing. There is a potential fire risk if the contacts are short circuited across a conductive object (such as keys in a pocket, for example).
- Take particular care when working with strobe / studio flash units to prevent damage to equipment and personal injury.

DISPOSAL

If you need to dispose of an H2F camera and/or batteries, please do so in an environmentally friendly manner at the local waste plant/ recycling centre or similar.



Victor Hasselblad AB and Hasselblad A/S reserve the right to make changes in descriptions, technical specifications and instructional information without prior notice and accepts no responsibility whatsoever, financial or otherwise, for any damages or losses incurred in connection with Hasselblad equipment.

Copyright © 2008

Victor Hasselblad AB & Hasselblad A/S

