

RFID System

V600 Series

Operation Manual

ID Controller

V600-CA5D02

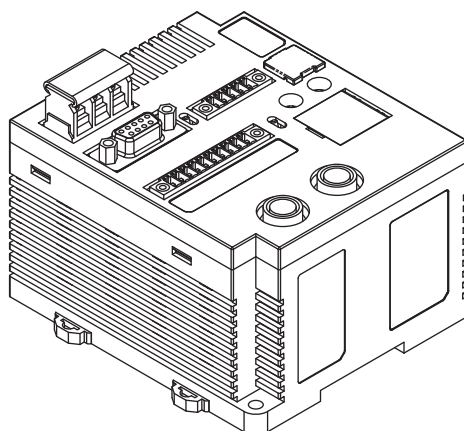

Preface

Thank you for purchasing an OMRON V600-series RFID System.

This manual provides information required to use a V600-series RFID System, including information on functions, performance, and application methods.

Observe the following precautions when using your V600-series RFID System.

- Allow the V600-series RFID System to be handled only by a professional with a knowledge of electrical systems.
- Read this manual thoroughly and be sure you understand the contents completely before attempting to use the V600-series RFID System.
- Keep this manual readily available in a safe location so that it can be referred to when required.

Preface	Warranty, Liability, and Safety Information (Always read this information.)	Preface
Section 1	Product Overview	Section 1
Section 2	Installation and Wiring	Section 2
Section 3	Preparing Communications	Section 3
Section 4	Function	Section 4
Section 5	Communications	Section 5
Section 6	Troubleshooting	Section 6
Section 7	Appendix	Section 7

RFID System

V600-CA5D02 ID Controller

Operation Manual

READ AND UNDERSTAND THIS DOCUMENT

Please read and understand this document before using the products. Please consult your OMRON representative if you have any questions or comments.

WARRANTY

OMRON's exclusive warranty is that the products are free from defects in materials and workmanship for a period of one year (or other period if specified) from date of sale by OMRON.

OMRON MAKES NO WARRANTY OR REPRESENTATION, EXPRESS OR IMPLIED, REGARDING NON-INFRINGEMENT, MERCHANTABILITY, OR FITNESS FOR PARTICULAR PURPOSE OF THE PRODUCTS. ANY BUYER OR USER ACKNOWLEDGES THAT THE BUYER OR USER ALONE HAS DETERMINED THAT THE PRODUCTS WILL SUITABLY MEET THE REQUIREMENTS OF THEIR INTENDED USE. OMRON DISCLAIMS ALL OTHER WARRANTIES, EXPRESS OR IMPLIED.

LIMITATIONS OF LIABILITY

OMRON SHALL NOT BE RESPONSIBLE FOR SPECIAL, INDIRECT, OR CONSEQUENTIAL DAMAGES, LOSS OF PROFITS OR COMMERCIAL LOSS IN ANY WAY CONNECTED WITH THE PRODUCTS, WHETHER SUCH CLAIM IS BASED ON CONTRACT, WARRANTY, NEGLIGENCE, OR STRICT LIABILITY.

In no event shall responsibility of OMRON for any act exceed the individual price of the product on which liability is asserted.

IN NO EVENT SHALL OMRON BE RESPONSIBLE FOR WARRANTY, REPAIR, OR OTHER CLAIMS REGARDING THE PRODUCTS UNLESS OMRON'S ANALYSIS CONFIRMS THAT THE PRODUCTS WERE PROPERLY HANDLED, STORED, INSTALLED, AND MAINTAINED AND NOT SUBJECT TO CONTAMINATION, ABUSE, MISUSE, OR INAPPROPRIATE MODIFICATION OR REPAIR.

SUITABILITY FOR USE

THE PRODUCTS CONTAINED IN THIS DOCUMENT ARE NOT SAFETY RATED. THEY ARE NOT DESIGNED OR RATED FOR ENSURING SAFETY OF PERSONS, AND SHOULD NOT BE RELIED UPON AS A SAFETY COMPONENT OR PROTECTIVE DEVICE FOR SUCH PURPOSES. Please refer to separate catalogs for OMRON's safety rated products.

OMRON shall not be responsible for conformity with any standards, codes, or regulations that apply to the combination of products in the customer's application or use of the product.

At the customer's request, OMRON will provide applicable third party certification documents identifying ratings and limitations of use that apply to the products. This information by itself is not sufficient for a complete determination of the suitability of the products in combination with the end product, machine, system, or other application or use.

The following are some examples of applications for which particular attention must be given. This is not intended to be an exhaustive list of all possible uses of the products, nor is it intended to imply that the uses listed may be suitable for the products:

- Outdoor use, uses involving potential chemical contamination or electrical interference, or conditions or uses not described in this document.
- Nuclear energy control systems, combustion systems, railroad systems, aviation systems, medical equipment, amusement machines, vehicles, safety equipment, and installations subject to separate industry or government regulations.
- Systems, machines, and equipment that could present a risk to life or property.

Please know and observe all prohibitions of use applicable to the products.

NEVER USE THE PRODUCTS FOR AN APPLICATION INVOLVING SERIOUS RISK TO LIFE OR PROPERTY WITHOUT ENSURING THAT THE SYSTEM AS A WHOLE HAS BEEN DESIGNED TO ADDRESS THE RISKS, AND THAT THE OMRON PRODUCT IS PROPERLY RATED AND INSTALLED FOR THE INTENDED USE WITHIN THE OVERALL EQUIPMENT OR SYSTEM.

PERFORMANCE DATA

Performance data given in this document is provided as a guide for the user in determining suitability and does not constitute a warranty. It may represent the result of OMRON's test conditions, and the users must correlate it to actual application requirements. Actual performance is subject to the OMRON Warranty and Limitations of Liability.

CHANGE IN SPECIFICATIONS

Product specifications and accessories may be changed at any time based on improvements and other reasons.

It is our practice to change model numbers when published ratings or features are changed, or when significant construction changes are made. However, some specifications of the product may be changed without any notice. When in doubt, special model numbers may be assigned to fix or establish key specifications for your application on your request. Please consult with your OMRON representative at any time to confirm actual specifications of purchased products.

DIMENSIONS AND WEIGHTS

Dimensions and weights are nominal and are not to be used for manufacturing purposes, even when tolerances are shown.

ERRORS AND OMISSIONS

The information in this document has been carefully checked and is believed to be accurate; however, no responsibility is assumed for clerical, typographical, or proofreading errors, or omissions.

PROGRAMMABLE PRODUCTS

OMRON shall not be responsible for the user's programming of a programmable product, or any consequence thereof.

COPYRIGHT AND COPY PERMISSION

This document shall not be copied for sales or promotions without permission.

This document is protected by copyright and is intended solely for use in conjunction with the product. Please notify us before copying or reproducing this document in any manner, for any other purpose. If copying or transmitting this document to another, please copy or transmit it in its entirety.

Safety Precautions



● Meaning of Signal Words

The following signal words and icons are used in this manual to indicate precautions when using the V600-CA5D02. The indicated precautions provide information that is vital to safety. Always observe all precautionary information.





The signal words and icons are as follows:

 WARNING	Indicates a potentially hazardous situation which, if not avoided, will result in minor or moderate injury, or may result in serious injury or death. Additionally there may be significant property damage.
--------------------------------------------------------------------------------------------------	--------------------------------------------------------------------------------------------------------------------------------------------------------------------------------------------------------------

● Meanings of Alert Symbols

	<p>Explosion Indicates the possibility of explosion under specific conditions.</p>
	<p>Prohibition Indicates general prohibitions.</p>

● Alert Statements in this Manual

 WARNING	
<p>This product is not designed for use in directly or indirectly detecting human bodies in safety-related applications. Do not use the product as a sensing device for human protection.</p>	
<p>A lithium battery is built into SRAM Data Carriers and may occasionally cause serious injury due to combustion, explosion, or burning. Dispose of SRAM Data Carriers as industrial waste and never disassemble, apply pressure that would deform, heat to higher than 100°C, or incinerate SRAM Data Carriers.</p>	
<p>A lithium battery is built into SRAM Data Carriers and may occasionally cause serious injury due to combustion, explosion, or burning. When replacing the lithium battery, never short-circuit the positive and negative terminals of a battery or charge, disassemble, apply deforming pressure, or expose the battery to fire.</p>	

Regulations and Standards

The V600-CA5D02 complies with the following standards.

1. UL Standards

UL (Underwriters Laboratories Inc.) conditions have been met.

UL508



Use the product connected to one of the following two circuits.

(1) Limited Voltage/Current Circuit (Approved in UL508)

A circuit that uses as its power supply the secondary coil of an insulated transformer that satisfies the following conditions:

- Maximum voltage (with no-load): 30 Vrms (42.4 V peak)

OR

- Maximum current: (1) 8 A (including when shorted) OR

(2) A current restricted by a circuit protective device (e.g., fuse) with the following ratings

No-load voltage (V peak)	Maximum current rating (A)
0 to 20	5.0
Over 20 to 30	$\frac{100}{\text{peak voltage}}$

(2) A circuit with a maximum voltage of 30 Vrms (42.4 V peak) that uses as its power supply a Class 2 power supply defined in UL1310 or a Class 2 transformer defined in UL1585

2. EMC Standards

The requirements of the EC Directive have been satisfied.

EMC Standards EN 61000-6-2

EN 61000-6-4

Precautions for Safe Use

Observe the following precautions to ensure safe usage of the product.

1. Do not use the product in environments subject to inflammable, explosive, or corrosive gases.
2. Do not disassemble, repair, or modify the product in any way.
3. Tighten the base mounting screws and terminal block screws securely.
4. Use the specified sizes of crimp terminals for wiring.
5. Always lock the lock mechanisms on any devices provided with them, such as cable connector lock screws.
6. Confirm that the DC power supply is within the rated power supply voltage (24 VDC +10%/-15%) before using it.
7. Do not reverse polarity when connecting the power supply.
8. Do not allow water to enter or insert wire in the gaps of the case. Fire or electric shock may result.
9. Always turn OFF the power supply to the ID Controller before attaching or removing the Read/Write Head.
10. If you suspect that anything is wrong with the product at any time, stop using it immediately, turn OFF the power supply, and consult with your OMRON representative.
11. When disposing of the product, dispose of it as industrial waste.
12. Observe all other precautionary information provided in this manual.

Precautions for Correct Use

Please observe the following precautions to prevent failure to operate, malfunctions, or undesirable effects on product performance.

1. Installation Location

Do not install the product in the following locations:

- Locations subject to corrosive gases, dust, dirt, metal powder, or salt
- Locations where the specified ambient operating temperature range is exceeded
- Locations subject to extreme temperature changes that may result in condensation
- Locations where the specified ambient operating humidity range is exceeded
- Locations where the product would be directly subjected to vibration or shock exceeding specifications
- Locations subject to contact with water, oil, or chemicals

2. Installation

- The product uses the 530-kHz frequency band to communicate with Data Carriers. Some devices, such as some motors, inverters, and switch mode power supplies, generate electromagnetic waves (i.e., noise) that can affect communications with the Data Carriers. If any of these devices are nearby, communications with Data Carriers may be affected or Data Carriers may be destroyed.

If the product is to be used near such devices, check the effects on communications before using the product.

- To minimize the general influence of noise, follow the following precautions:
 - (1) Ground any metallic material located around the product to 100 W or less.
 - (2) Keep product wiring away from high voltage or heavy current.
- The product does not provide a water-proof structure. Do not use it where mists are present.
- Do not use chemicals that will affect product materials.
- Tighten screws to 1.2 N·m maximum when mounting the product.
- Communications performance may be reduced due to mutual interference if more than one Read/Write Head is installed in the same vicinity. Refer to the *Read/Write Heads and SRAM Data Carriers Operation Manual* (Cat. No. Z127) and *Read/Write Heads and EEPROM Data Carriers* (Cat. No. Z128) and confirm that there is no mutual interference between Read/Write Heads.

3. Storage

Do not store the product in the following locations:

- Locations subject to corrosive gases, dust, dirt, metal powder, or salt
- Locations where the specified ambient operating temperature range is exceeded
- Locations subject to extreme temperature changes that may result in condensation
- Locations where the specified ambient operating humidity range is exceeded
- Locations where the product would be directly subjected to vibration or shock exceeding specifications
- Locations subject to contact with water, oil, or chemicals

4. Cleaning

- Do not use thinners for cleaning. Resin materials and the case coating will be dissolved by thinners.

Meanings of Symbols



CHECK!

Indicates particularly important points related to a function, including precautions and application advice.



Indicates page numbers containing relevant information.



Indicates reference to helpful information and explanations for difficult terminology.

MEMO

TABLE OF CONTENTS

Preface

Warranty, Liability, and Safety Information	2
Safety Precautions	4
Regulations and Standards	5
Precautions for Safe Use	5
Precautions for Correct Use	6
Meanings of Symbols	7

Section 1 Product Overview 11

Features	12
Names and Functions of Components	13
System Configuration	16
Overall Flow of Application	19

Section 2 Installation and Wiring 21

Installation	22
Wiring	24

Section 3 Preparing Communications 45

Switch Settings	46
Test operation	55

Section 4 Function 57

Write Protect Function	58
Data Carrier Service Life Detection	61
Data Carrier Memory Check Function	64

Section 5 Communications	65
Movement of Data Carriers and Command Status	66
Command Format	71
Communications Commands	76
General Communications Subcommands	118
Host Device Commands	121
Other Commands	132
End Codes	133
Section 6 Troubleshooting	135
Diagnostic Functions	136
Error Lists	137
Troubleshooting	139
Maintenance and Inspection	140
Troubleshooting Flowcharts	141
Section 7 Appendix	147
Specifications and Dimensions	148
Characteristics According to Application Conditions	151
Data Carrier Memory Map	157
Data Carrier Memory Capacities and Memory Types	158
ASCII Table	159
Degree of Protection	160
Revision History	162

Section 1

Product Overview

▣ Features	12
▣ Names and Functions of Components	13
▣ System Configuration	16
▣ Overall Flow of Application	19

Features

The V600-CA5D02 ID Controller is connected to a V600-H□□ Read/Write Head, performs data read/write operations for V600-D□KR□□, V600-D□KF□□, or V600-D23P□□ Data Carriers according to commands from the host device, and returns responses to the host device.

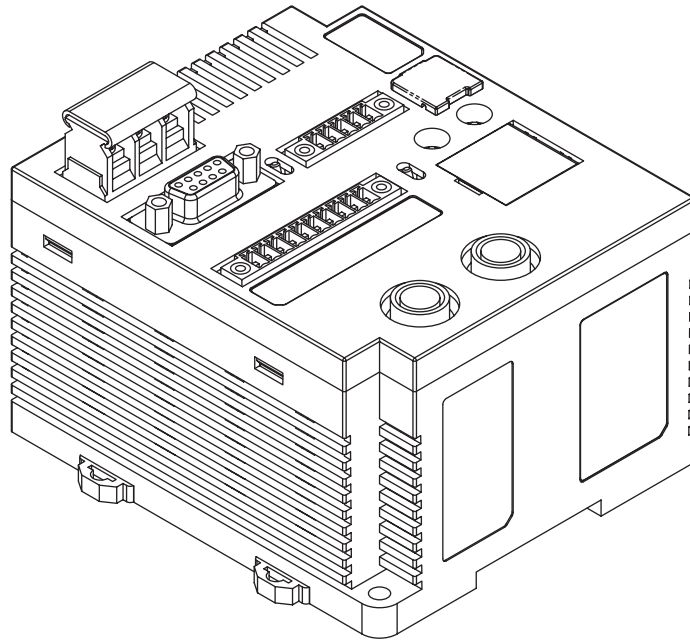

Names and Functions of Components

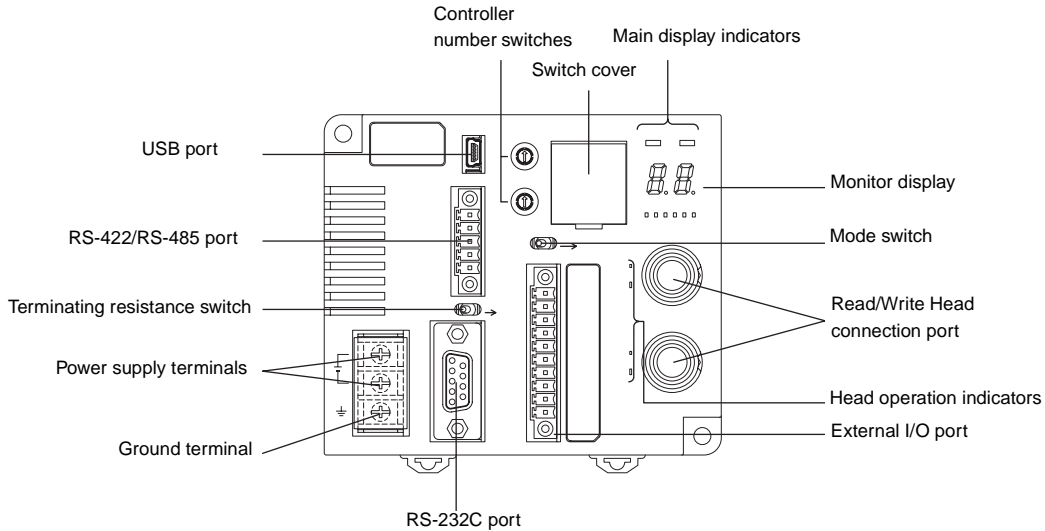

■ Power Supply and Ground Terminals

Name	Description
Power supply terminals	Supply 24 VDC. Recommended power supply: S8VS-03024 (manufactured by OMRON)
Ground terminal	This is the ground terminal. Connected a dedicated ground line grounded to 100 W or less.

■ External I/O Port

Connect the external I/O port to the external I/O signals.

Name	Description
RUN	Turns ON when the ID Controller is operating normally and communications are possible with the host device.
BUSY	Output from when a command is received from the host device until communications have been completed.
ERROR	Output for 500 ms when there is an error in Data Carrier communications, host device communications, or hardware. The output time can be changed with the SET PARAMETER (SP) command.
OUT1	User output 1, which can be manipulated using the CONTROL CONTROLLER (CC) command.
OUT2	User output 2, which can be manipulated using the CONTROL CONTROLLER (CC) command.
COM_O	The output common terminal.
RST	An external reset input for emergency stopping. The ID Controller will be reset when RST is input.
TRG/IN1	If pin 4 of SW4 (lower trigger setting) is ON, a RECEPTION COMPLETED command is executed for Read/Write Head 1 on the rising edge of this input. If pin 4 of SW4 is OFF, this input is used as user input 1, which can be read with the CONTROL CONTROLLER (CC) command.
TRG/IN2	If pin 4 of SW4 (lower trigger setting) is ON, a RECEPTION COMPLETED command is executed for Read/Write Head 2 on the rising edge of this input. If pin 4 of SW4 is OFF, this input is used as user input 2, which can be read with the CONTROL CONTROLLER (CC) command.
COM_I	The input common terminal.

■ RS-232C Port

The RS-232C port is used for communications with the host device. The port conforms to RS-232C and can be connected to a computer, programmable controller, or other host device.

■ RS-422/RS-485 Port

The RS-422/RS-485 port is used for communications with the host device. The port conforms to RS-422/RS-485 and can be connected to a computer, programmable controller, or other host device.

■ USB Port

The USB port can be used to easily connect a computer using a USB cable. The port conforms to USB 1.1.

If the USB port is used to connect to the host device, the connection must be 1:1 regardless of the setting of pin 9 of SW3.

 The USB port is not used for control operations. When constructing a system, always use the RS-232C or RS-422/RS-485 port.

CHECK!  p.16

■ Read/Write Head Connection Port

Connect the Read/Write Head connection port to a V600-series Read/Write Head.

■ Controller Number Switches

The controller number switches are used to set a controller number when more than one ID Controller is connected to a single host device.

 Refer to *Setting the Controller Number Switches (SW1 and SW2)* for more information.

CHECK!  p.48

■ Switch Cover

There are two DIP switches located behind the switch cover.

Refer to *Setting the DIP Switches (SW3 and SW4)* for more information.

 Refer to *DIP Switches (SW3 and SW4)* for more information.

CHECK!  p.49

■ Mode Switch

The mode switch changes the ID Controller's operating mode between RUN mode and MAINTENANCE mode.

 Refer to *Setting the Mode Switch* for more information.

CHECK!  p.51

■ Terminating Resistance Switch

The terminating resistance switch connects and disconnects the built-in terminating resistance.

 Refer to *Setting the Terminating Resistance* for more information.

CHECK!  p.51

■ Main Display Indicators

Name	Color	Description
RUN/RST	Green	Lit when the ID Controller is operating normally.
	Red	Lit when the external reset input is received.
COMM	Green	Lit when communicating normally with the host device.
	Red	Lit when an error is detected in communications with the host device.

■ Head Operation Indicators

Name	Color	Description
COMM1	Yellow	Lit when a communications command for a Data Carrier is being processed for Read/Write Head 1.
NORM1/ERR1	Green	Lights once at a normal end to processing for Read/Write Head 1.
	Red	Lights once at an error end to processing for Read/Write Head 1.
COMM2	Yellow	Lit when a communications command for a Data Carrier is being processed for Read/Write Head 2.
NORM2/ERR2	Green	Lights once at the end of normal processing for Read/Write Head 2.
	Red	Lights once at an error end to processing for Read/Write Head 2.

■ Monitor Display

Name	Color	Mode	Description
7-segment display (2 digits)	Red	RUN mode, end code display	The end code is displayed.
		RUN mode, I/O display	User I/O status is displayed.
		MAINTENANCE mode	The end code is displayed.

■ End Code Display Mode (Pin 3 of SW4 Turned OFF)

The end code for command processing is displayed. End codes are displayed with two hexadecimal digits, as shown below.
For normal responses or warning responses, the display lights. For error responses, the display flashes.

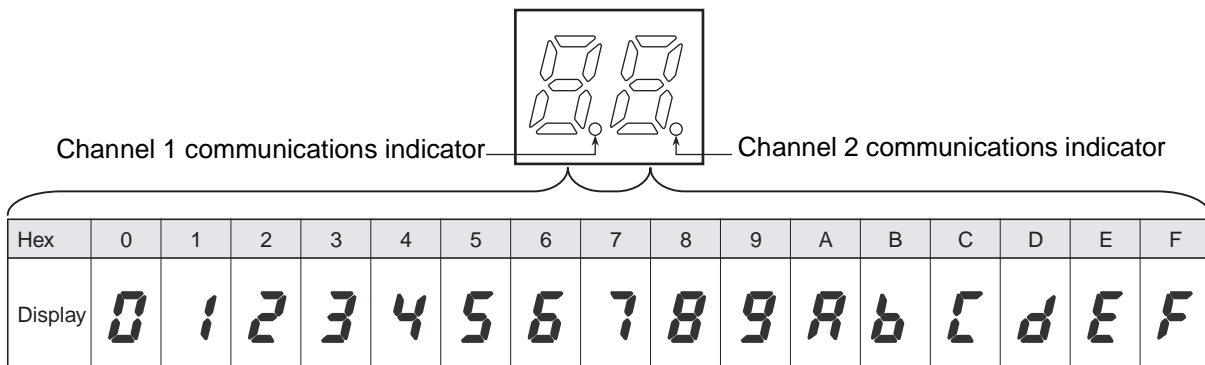

■ I/O Display Mode (Pin 3 of SW4 Turned ON)

The monitor display will show the ON/OFF status of the I/O terminals or the error status. The segments will be light when the I/O is ON and not lit when the I/O is OFF, as shown below. Error displays will light when the error occurs and then go out after a short period of time.

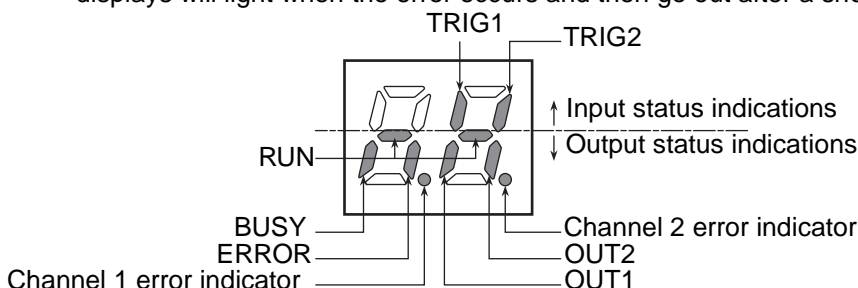

System Configuration

1:1 Connections

The host device is connected via RS-232C.

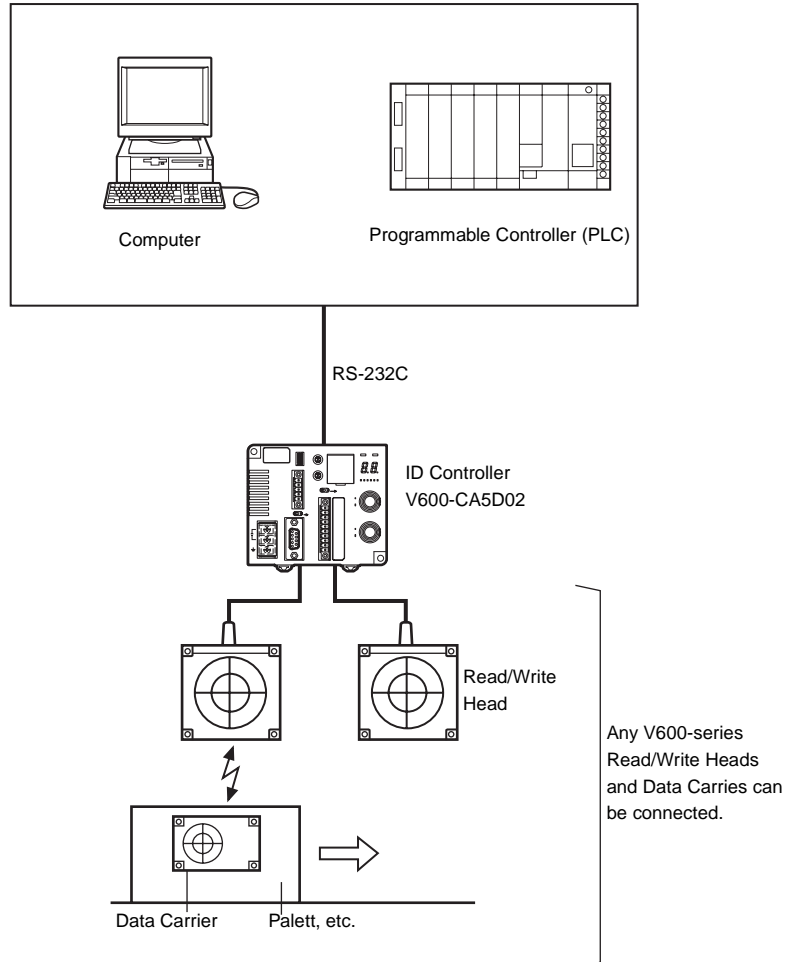

1:N Connections with RS-232C Host Device Connection

The host device is connected via RS-232C and then other ID Controllers are connected via RS-422/RS-485.

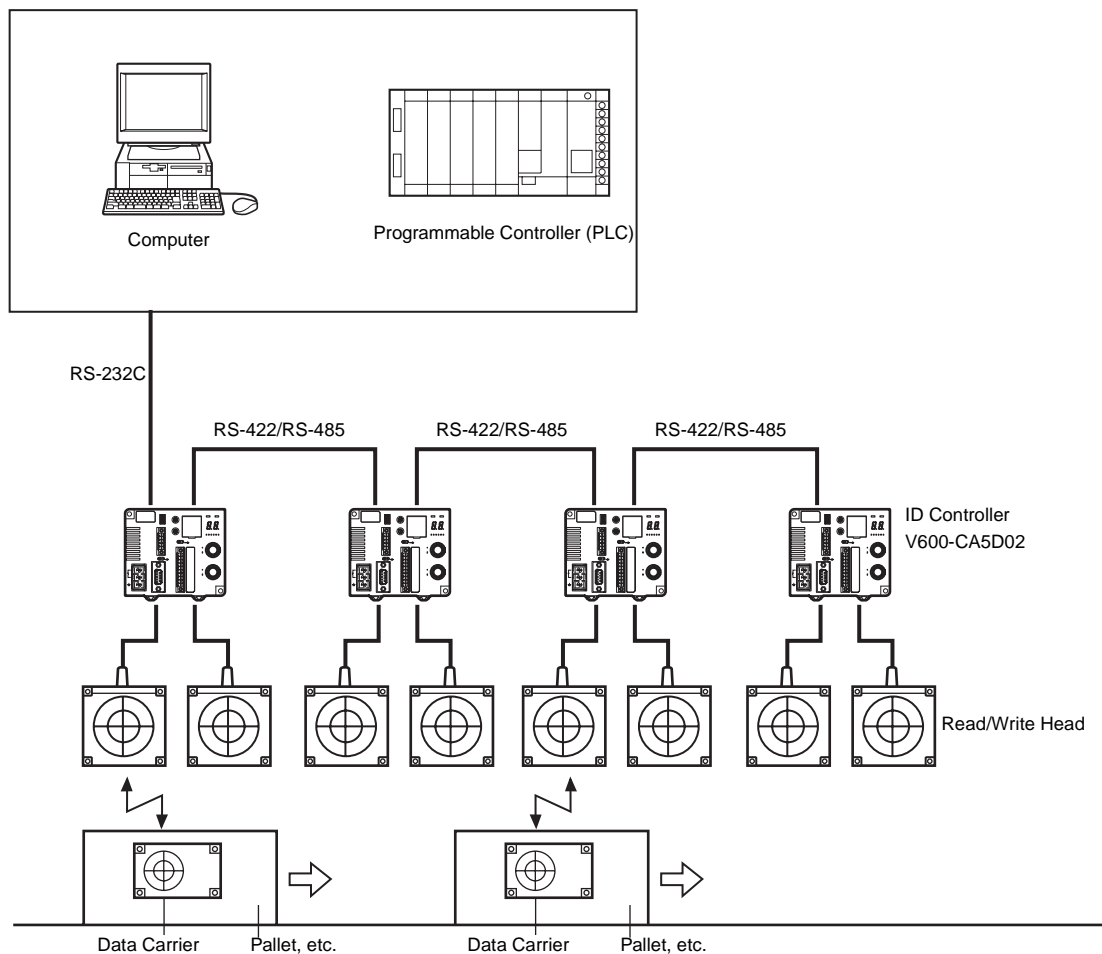

1:N Connections with RS-422/RS485 Host Device Connection

The host device is connected via RS-422 or RS-485 and then other ID Controllers are connected via RS-422/RS-485.

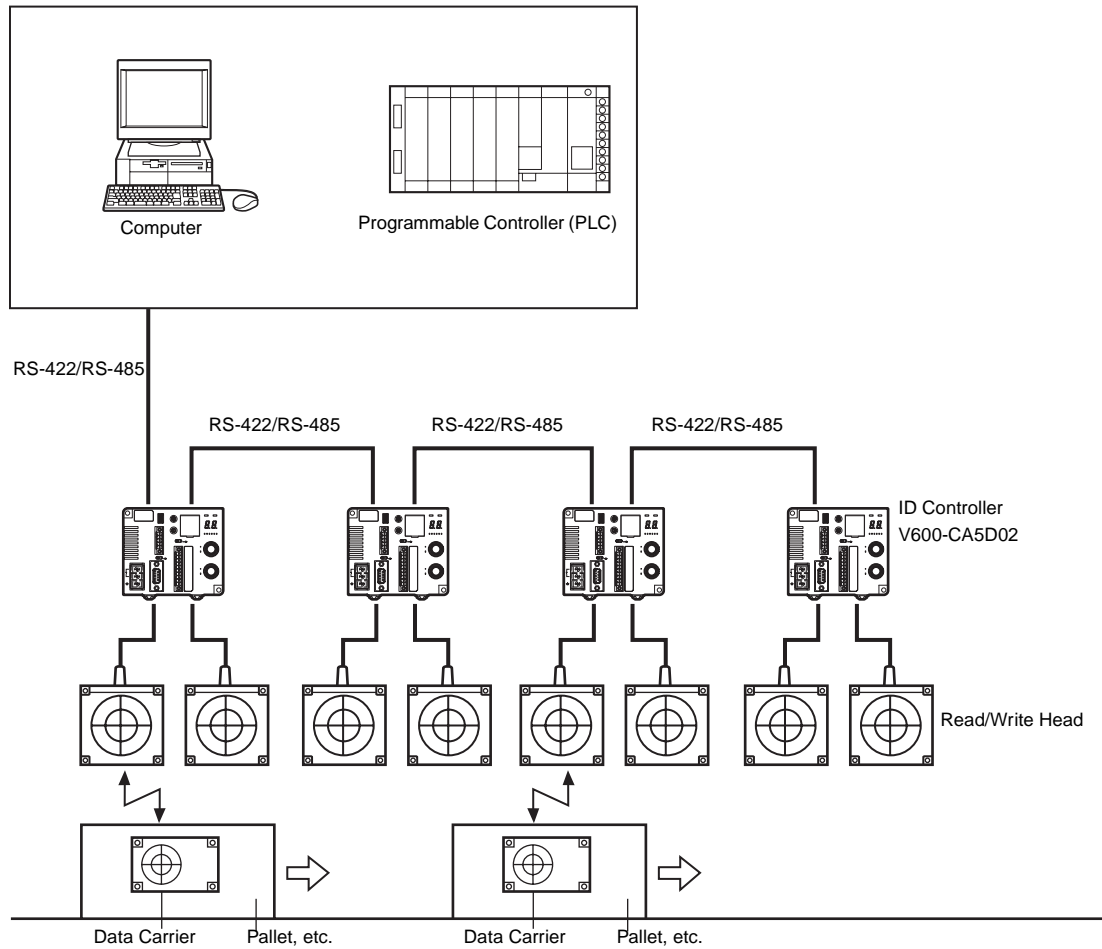

Overall Flow of Application

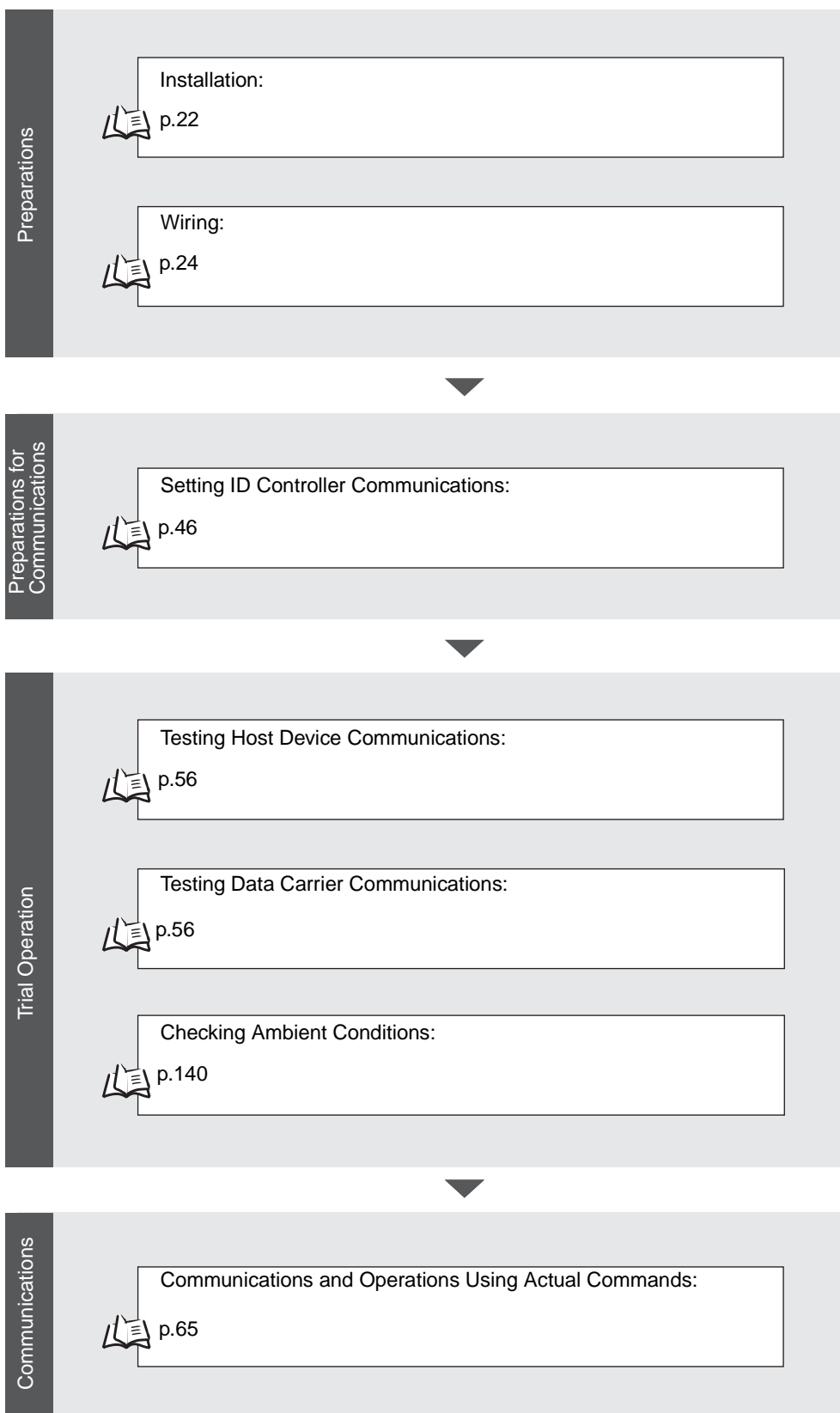

MEMO

Section 2

Installation and Wiring

▣ Installation	22
▣ Wiring	24

Installation

Observe the following precautions when installing the V600-CA5D02 ID Controller to enable proper performance of all functions.

Installation Environment

Do not install the ID Controller in the following locations.

- Locations where the ambient operating temperature is not between -10 and 55°C or locations where condensation may occur as the result of rapid variations in temperature
- Locations where the ambient operating humidity is not between 35% and 85%
- Locations subject to corrosive gases, inflammable gases, dust, dirt, metal powder, or salt
- Locations subject to direct vibration or shock
- Locations subject to direct sunlight
- Locations subject to contact with water, oil, or chemicals
- Location over 2,000 m above sea level

Mounting Position in a Control Panel

The operating temperature range of the ID Controller is from -10 to 55°C . When installing the ID Controller in a control panel, pay attention to the following points:

- Provide enough space around the Controller for ventilation.
- Do not install the ID Controller in the vicinity of equipment generating heat (such as heaters, transformers, and large resistors).

Installation Methods

■ Mounted in a Panel

When mounting directly to a control panel, always use flat washers and M4 screws.
Recommended tightening torque: 1.2 N·m

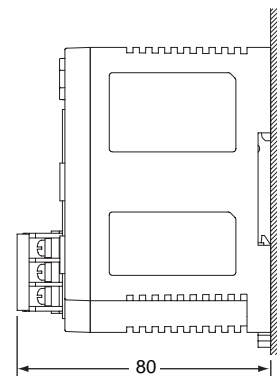
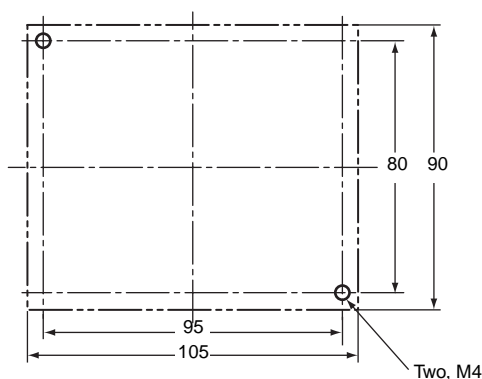

■ Mounting to DIN Rail

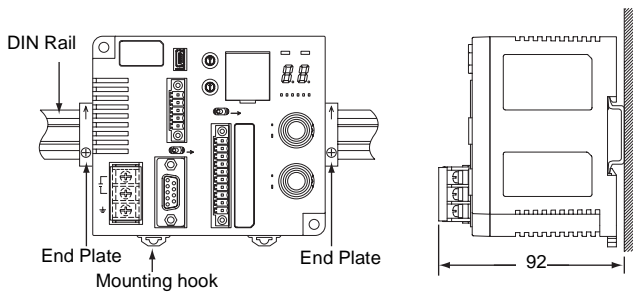

1. When mounting the ID Controller to DIN Rail, hook the ID Controller at point A and then press in direction B.
2. To remove the ID Controller from the DIN Rail, pull out the mounting hook.

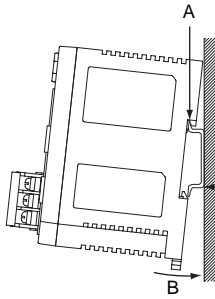

Recommended DIN Rail
PFP-100N2 (rail length: 1 m)
(manufactured by OMRON)

DIN Rail
PFP-100N2

End Plate
PFP-M

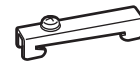
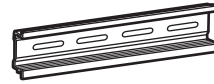

Attaching End Plates

An End Plate can be easily attached by catching the bottom of the End Plate on the DIN Rail, then the top, and then pulling down on the End Plate and tightening the lock screw. Recommended tightening torque: 1.2 N·m

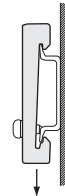

■ Installation Interval

When mounting more than one V600-CA5D02 ID Controller side by side, leave at least 10 mm between the ID Controllers to allow for cooling.

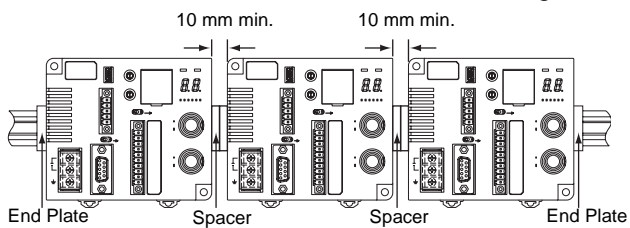

Use at least two DIN Rail Spacers manufactured by OMRON. (One Spacer has a width of 5 mm.)

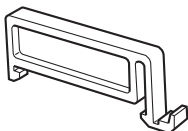

Spacer
PFP-S

Wiring

Power Supply and Ground

- The power supply and ground terminals use M3 self-rising terminals. If using crimp terminals for wiring, use ones with the following specifications.

Recommended tightening torque: 0.5 N·m

Examples of Applicable Crimp Terminals

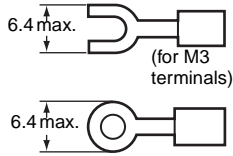

Examples of Applicable Crimp Terminals

Manufacturer	Model	Applicable wire size	Shape
J.S.T. Mfg Co.	1.25-N3A	0.25 to 1.65 mm ² (AWG22 to AWG16)	Forked
	V1.25N3A		
	1.25-MS3		Round
	V1.25-MS3		

- Supply 24 VDC to the ID Controller. Make sure that the voltage fluctuation is within the range of 20.4 to 26.4 VDC (24 VDC+10%/–15%).

- Countermeasures against noise superimposed on power lines is provided in the IC Controller. Supplying power through a filter can be used to substantially reduce ground noise.

- Use a twisted-pair cable for the power supply line.

- To improve noise immunity, ground to 100 Ω or less and use a dedicated ground.

- Use a class-2 power supply.

- Recommended DC Power Supply: Compact, DIN-rail Mounting (Manufactured by OMRON)

Model	Output capacity	Input current
S8VS-03024	1.3 A at 24 VDC	100 to 240 VAC

Although the rated power consumption of the ID Controller is 1.3 A at 24 VDC (30 W), take into consideration the inrush current when deciding the capacity of the power supply. Use a power supply with a capacity of 1.3 A minimum at 24 VDC.

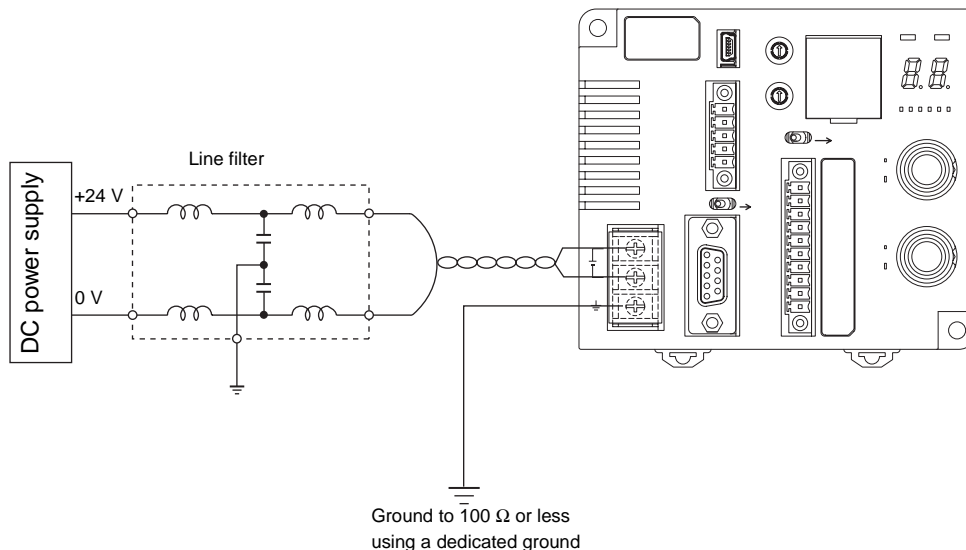

Input and Output Lines

■ RESET Signal Input Precautions

- Make sure that the input voltage of the RESET signal does not exceed the maximum voltage (26.4 V). If the maximum voltage is exceeded, the ID Controller may malfunction.
- To improve the noise immunity, separate the wiring of the input lines from high-voltage equipment or power lines by at least 1 m.

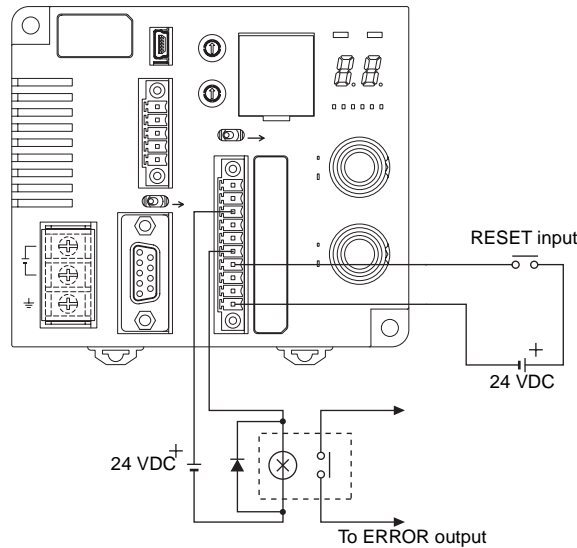

■ Error Signal Input Precautions



- The maximum switching capacity of the output terminals is 100 mA at 24 VDC (+10%/–15%). If a voltage or load that exceeds the maximum switching capacity is used, the ID Controller may malfunction.
- Use an auxiliary relay (100 mA max. at 24 VDC) in the output circuit.

■ Pin Arrangement

Pin No.	Name
1	RUN
2	BUSY
3	ERROR
4	OUT1
5	OUT2
6	COM_O
7	RST
8	TRG/IN1
9	TRG/IN2
10	COM_I

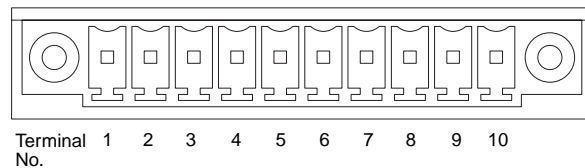
• Controller Terminal Arrangement



 Refer to *External I/O Port* for more information on the external I/O port.
CHECK!  p.13

■ Connecting the Cable

Use the connector provided with the ID Controller.

		Manufacturer	Model	Remarks
Cable	I/O lines	---	---	0.5 mm ² (equivalent to AWG20)
Connector		Phoenix Contact	MC1.5/10-STF-3.5	---
Crimp terminals	Connecting one line per terminal		AI0.5-8WH	---
	Connecting two lines per terminal		AI-TWIN2×0.5-8WH	---
Crimp tool				CRIMPFOX UD6

1. Crimp the crimp terminals to the stripped section of the wires.

2. Be sure that the connector is oriented properly and insert the wires in the connector holes.

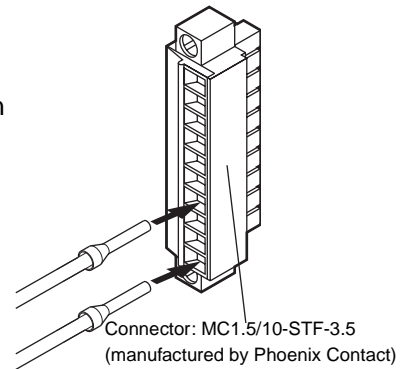

3. Tighten the wire lock screws securely.

Recommended tightening torque: 0.22 N·m



A normal screwdriver is tapered at the end and will not reach all the way to the back. Use a small flat-blade screw driver with a consistent width.

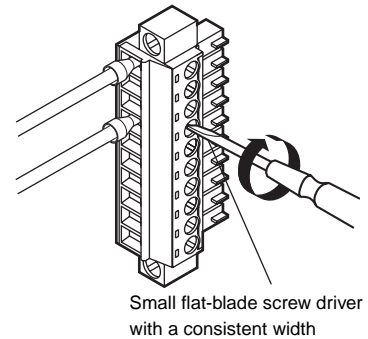

4. Connect the wired connector to the ID Controller.

Align the cable connector with the connector on the ID Controller, hold onto the connector, press the connector all the way in, and tighten the lock screws.

Recommended tightening torque: 0.4 N·m

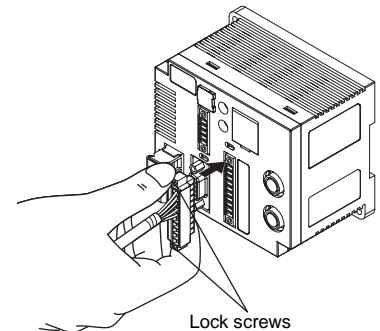

Removing the Connector

Loosen the two lock screws completely, hold onto the protruding portion of the connector, and pull the connector straight out and off. If the connector is difficult to remove, hold the ID Controller and pull the connector off.



Do not wire the connector while it is connected to the ID Controller.

RS-232C Port

Pin Arrangement

Pin No.	Abbreviation	Signal direction		Signal name
		Input	Output	
9	SG	---	---	Signal ground or common return line
2	SD	---	○	Send data
3	RD	○	---	Receive data
4	RS	---	○	Request to send
5	CS	○	---	Can send

Pin Arrangement

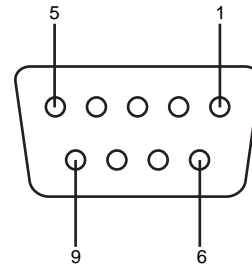

(The example at the left is for connecting a shielded cable to the host device.)

Connecting to the Host Device

Connection Example to OMRON PLC

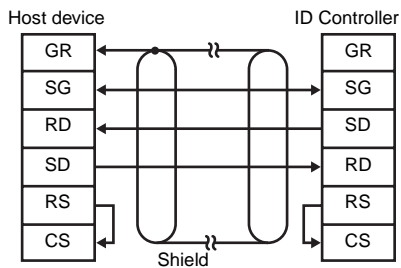

Recommended Cable

Model	Manufacturer
XW2Z-□□□T	OMRON

- Note 1. Ground the shield at the host device to prevent malfunctions.
2. Pins 4 (RS) and 5 (CS) are connected inside the connector.

Connection Example to DOS Computer (IBM PC/AT or Compatible) (This example uses a 9-pin D-Sub connector.)

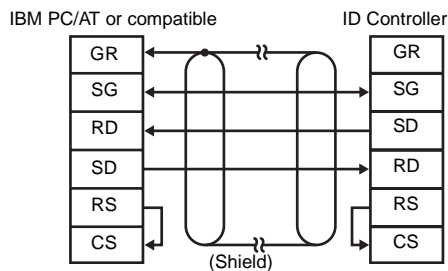

Recommended Cable

Model	Manufacturer
XW2Z-□□□S-V	OMRON

- Note 1. The ID Controller connector on the interface cable is male and the computer connector is female.
2. Ground the shield at the host device to prevent malfunctions.



For 1:N connections, refer to *Connecting between ID Controllers (1:N Connections)*.

CHECK! p.31

■ Assembling and Connecting the Communications Connector

Use the communications connector provided with the ID Controller. The user must provide the connecting cable and the host computer connector. The ID Controller connector is manufactured by OMRON and is protected from electromagnetic interference (EMI).

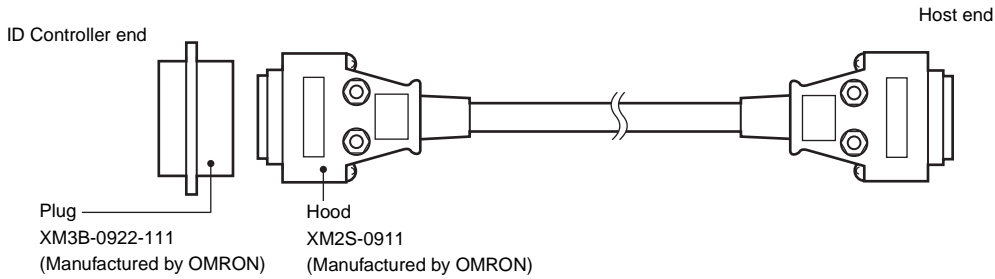

■ Connector Assembly

1. Prepare the end of the cable.

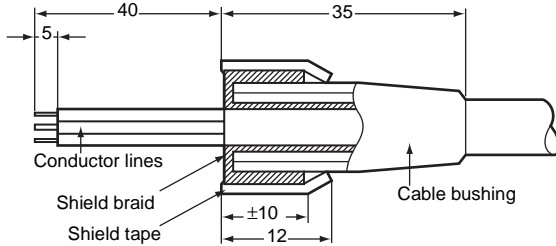

- First pass the cable through the cable bushing.
- Unwind the shielded braid and turn the braid back over the cable bushing. Turn approximately 10 mm of the shielded braid back over the cable bushing.
- Wrap the lines with sealing tape.

2. Solder conductor lines and plug pins.

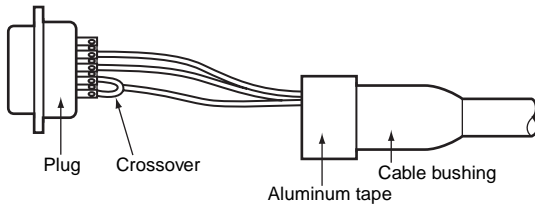

Pin No.	Abbrevia- tion	Signal name
9	SG	Signal ground
2	SD	Send data
3	RD	Receive data
4 (See note.)	RS	Request to send
5 (See note.)	CS	Can send

Note Short pins 4 (RS) and 5 (CS) with a crossover line inside the connector.

3. Set the hood housing A2 onto the plug, and secure the aluminum tape section with a clamp.

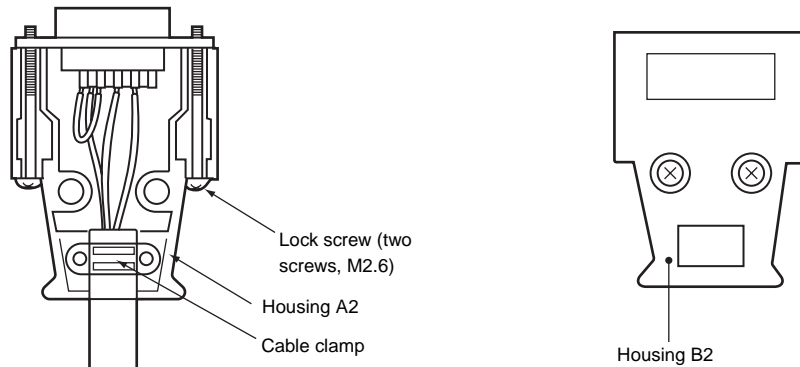

4. Tighten the two connector holding screws, and then cover the assembly with housing B2 to complete the connector.

■ Inserting and Removing the Connector

- It is extremely important to hold the connector to attach and insert it properly. After inserting the connector, use a Phillips screwdriver and fully tighten the two lock screws. Recommended tightening torque: 0.3 N·m.
- To remove the connector, loosen the two lock screws completely, hold onto the protruding portion of the connector hood, and pull the connector straight out and off. If the connector is difficult to remove, hold the ID Controller and pull the connector off.

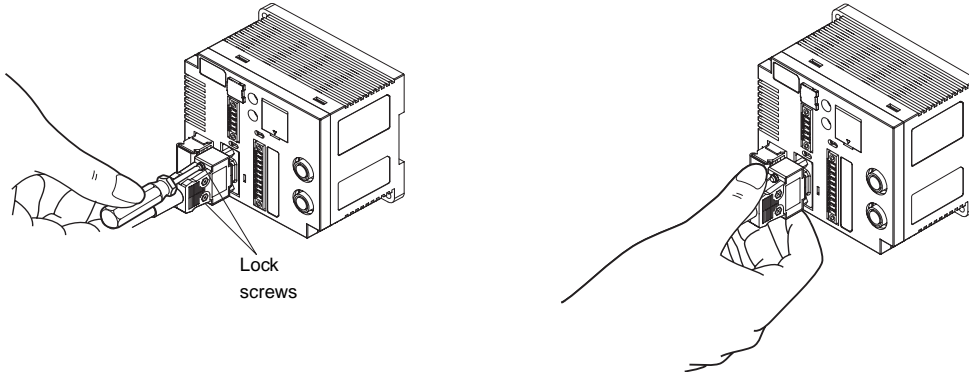

RS-422/RS-485 Port

Pin Arrangement

Pin No.	Name	Description
1	RDA(-)	Receive data
2	RDB(+)	Receive data
3	SDA(-)	Send data
4	SDB(+)	Send data
5	SG	SG

*Using RS-485 is possible by shorting pins 1 and 3 and pins 2 and 4, and changing the setting to RS-485.

Pin Arrangement

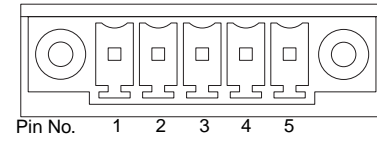

Connecting to the Host Device

RS-422 Connection

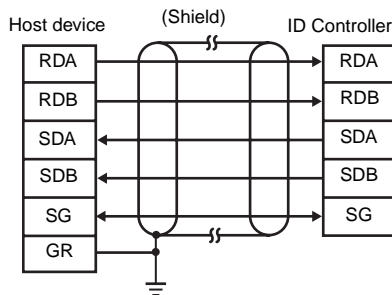

Note. Ground the shield at the host device to prevent malfunctions.

RS-485 Connection

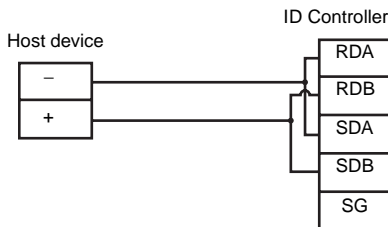

Note. Short pins 1 and 3 and pins 2 and 4. Do not connect anything to the ID Controller's SG.

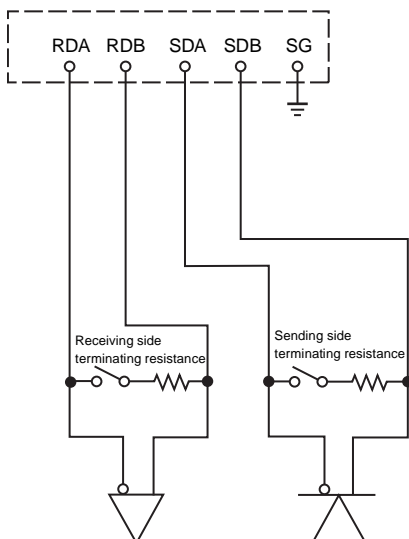

Terminating resistance: RS-422: 220 Ω, RS-485: 110 Ω



Note: Turn ON the terminating resistance at the nodes on both ends of the main cable.
Turn OFF the terminating resistance at all other nodes. Normal transmissions will not be possible if the terminating resistance is ON at any node other than the end nodes.

■ Connecting between ID Controllers (1:N Connections)

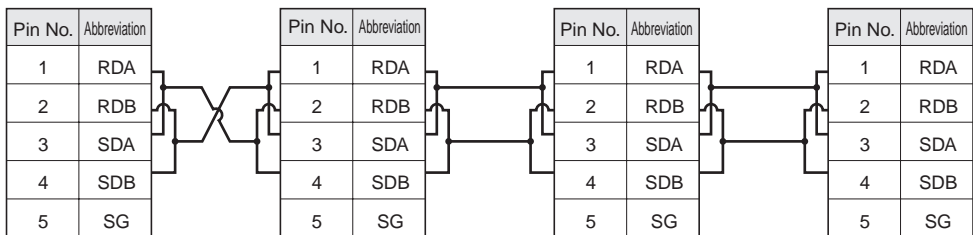
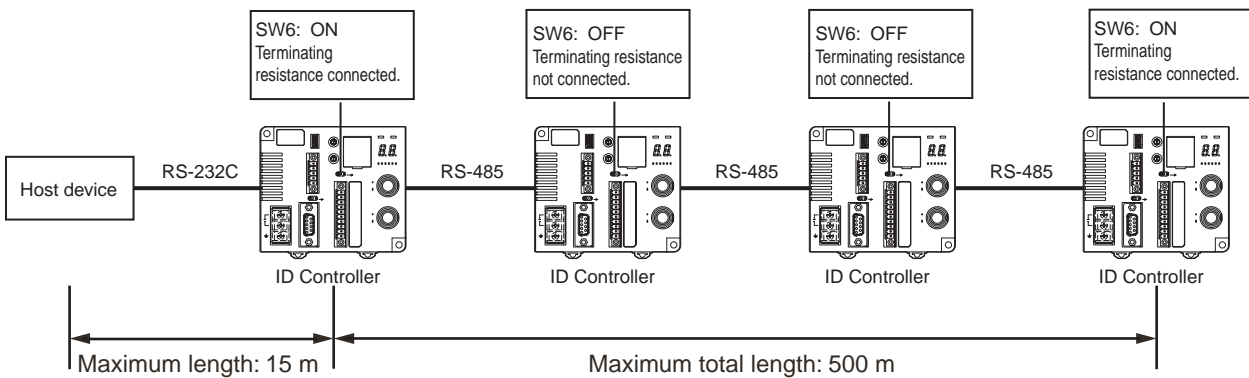
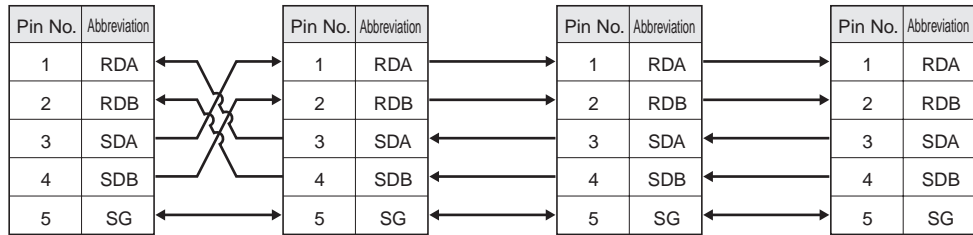
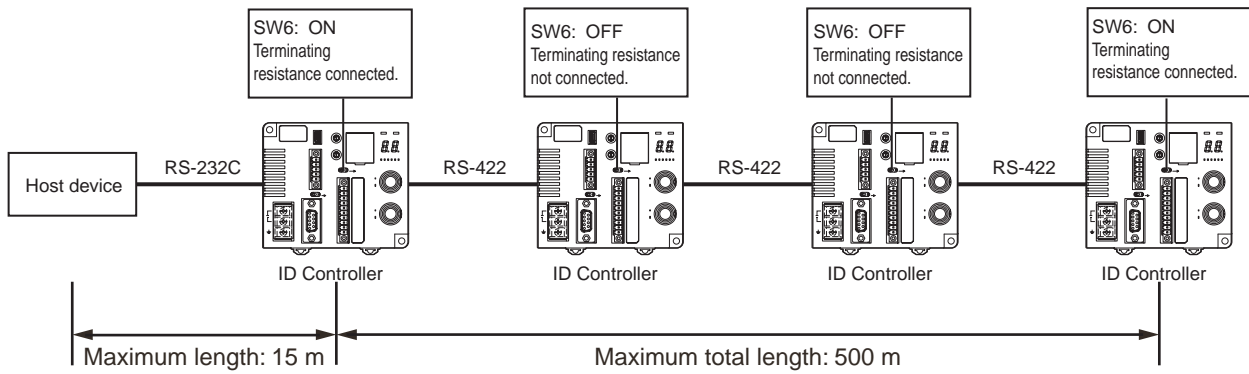
■ RS-232C Host Device Connection



Note: Using RS-485 is possible by shorting pins 1 and 3 and pins 2 and 4, and changing the setting to RS-485.

 For the RS-232C connection between the host device and ID Controller, refer to *Connecting to the Host Device*.
CHECK!  p.27

 If RS-232C communications are used first by the ID Controller, receiving RS-422/RS-485 communications will be prohibited. If RS-422/RS-485 communications are used first by the ID Controller, receiving RS-232C communications will be prohibited. It is thus necessary to turn OFF the power supply before changing the ID Controller system No. configuration.
CHECK!

■ RS-422 Host Device Connection

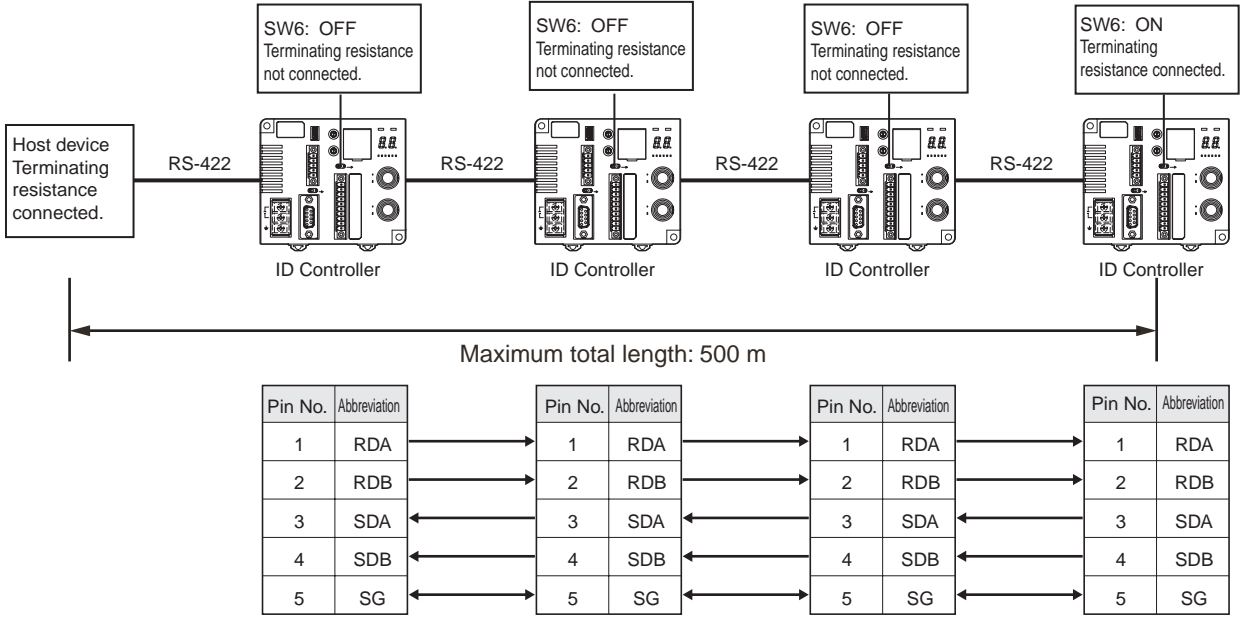

For the RS-422 connection between the host device and ID Controller, refer to *RS-422 Connections*.

p.30



If RS-232C communications are used first by the ID Controller, receiving RS-422/RS-485 communications will be prohibited. If RS-422/RS-485 communications are used first by the ID Controller, receiving RS-232C communications will be prohibited. It is thus necessary to turn OFF the power supply before changing the ID Controller system configuration.

■ RS-485 Host Device Connection

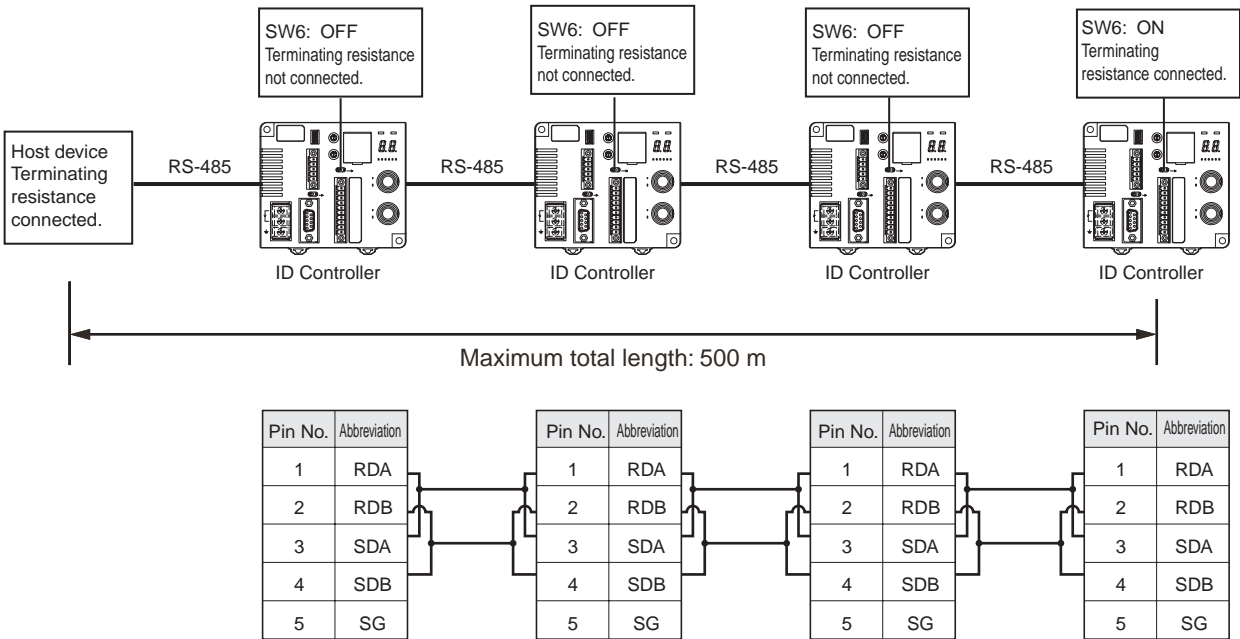

Note: Using RS-485 is possible by shorting pins 1 and 3 and pins 2 and 4, and changing the setting to RS-485.



For the RS-485 connection between the host device and ID Controller, refer to *RS-485 Connections*.

p.30



If RS-232C communications are used first by the ID Controller, receiving RS-422/RS-485 communications will be prohibited. If RS-422/RS-485 communications are used first by the ID Controller, receiving RS-232C communications will be prohibited. It is thus necessary to turn OFF the power supply before changing the ID Controller system configuration.

■ Connecting the Cable

Use the connector provided with the ID Controller. The user must provide the connecting cable.

		Manufacturer	Model	Remarks
Cable	RS-422 signal line	---	---	0.5 mm ² (equivalent to AWG20)
Connector		Phoenix Contact	MC1.5/5-STF-3.5	---
Crimp terminals	Connecting one line per terminal		AI0.5-8WH	---
	Connecting two lines per terminal		AI-TWIN2×0.5-8WH	---
Crimp tool				CRIMPFOX UD6

1. Crimp the crimp terminal to the stripped section of the wire.

2. Be sure that the connector is oriented properly and insert the wires in the connector holes.

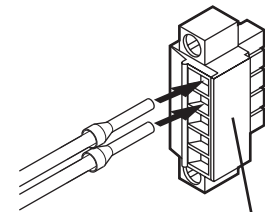

Connector: MC1.5/5-STF-3.5
(manufactured by Phoenix Contact)

3. Tighten the wire lock screws securely.

Recommended tightening torque: 0.22 N·m



CHECK!

A normal screwdriver is tapered at the end and will not reach all the way to the back. Use a small flat-blade screw driver with a consistent width.

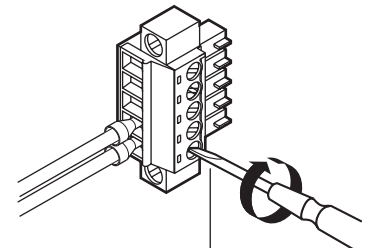

Small flat-blade screw driver
with a consistent width

4. Connect the wired connector to the ID Controller.

Align the cable connector with the connector on the ID Controller, hold onto the connector, press the connector all the way in, and tighten the lock screws.

Recommended tightening torque: 0.4 N·m

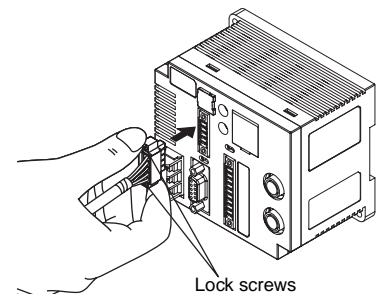

Lock screws



CHECK!

Removing the Connector

Loosen the two lock screws completely, hold onto the protruding portion of the connector, and pull the connector straight out and off. If the connector is difficult to remove, hold the ID Controller and pull the connector off.



CHECK!

Do not wire the connector while it is connected to the ID Controller.

USB Port

The host device can be connected using a USB cable (series A and mini USB series B connectors).



The USB port is not used for control operations. When constructing a system, always use the RS-232C or RS-422/RS-485 port.

CHECK!  p.16

Pin Arrangement

Pin No.	Name	Description
1	VBUS	Power supply
2	D-	USB data (-)
3	D+	USB data (+)
5	GND	Ground

• Pin Arrangement

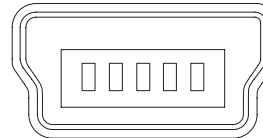

Pin No. 1 2 3 4 5

Pin No.	Abbreviation	Pin No.	Abbreviation
1	VBUS	1	VBUS
2	D-	2	D-
3	D+	3	D+
4	GND	5	GND
-	FG	-	FG

Inserting and Removing the Connector

1. Connecting the Mini USB Series B Connector to the ID Controller

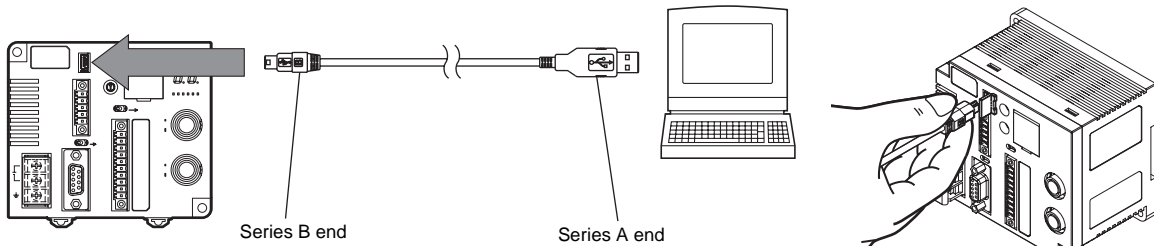

The connectors are capped when shipped from the factory. If the USB connector is not used, leave the cap in place to protect against dust, dirt, and static electricity.

CHECK!



Removing the Connector

Hold onto the base of the connector pull it straight out. If the connector is difficult to remove, hold the ID Controller and pull the connector off.

CHECK!

2. Connecting the Series A Connector to the Host Device

Align the connectors in the proper orientation and press straight in.

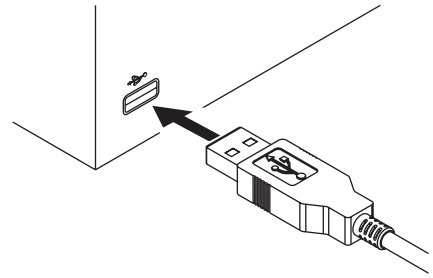

3. Removing the Connector from the Host Device

Close the software application at the host device and then pull the connector straight out.



If the connector is removed while the software running at the host device, operation may stop due to a software malfunction.

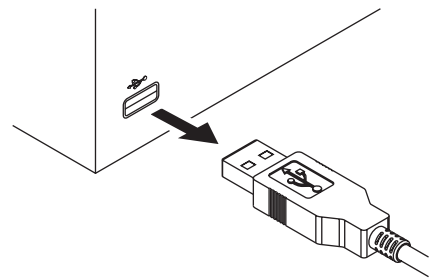

■ Attaching a Ferrite Core

USB connections can be easily affected by noise.

Use the following ferrite core to increase noise immunity.

Manufacturer	Model
SEIWA	E04SR301334

1. Attach the above ferrite core to the USB cable.

Attach the ferrite core to the end of the cable with the mini USB series B connector. Press the ferrite core closed until you hear it click into place. The ferrite core should be located about 10 cm or less from the connector.

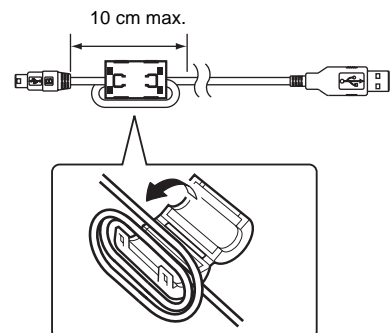

■ Installing the USB Driver

When using a USB cable to connect the ID Controller to the host device for the first time, the USB Driver must be installed on the host device.

■ Installing the USB Driver in the Computer

The V600-CA5D02 supports Windows 2000 and Window XP operating systems. Install the driver in the host device following the procedure corresponding to the OS being used. Operation on other OS is not supported.

Operation on other OS is not supported.

Windows 2000

1. Turn ON the power to the personal computer and start Windows 2000.

2. Connect the ID Controller to the personal computer using the USB interface.



Refer to *USB Port* for more information.

CHECK!



p.34

The following window will be displayed when the ID Controller is connected.

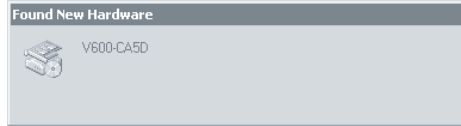

3. When the following window is displayed, click the **Next** Button.



4. Select *Search for a suitable driver for my device (recommended)* and then click the **Next** Button.



5. Select *Specify a location* and then click the **Next** Button.



6. Click the **Browse** Button, and select the folder in which the downloaded file *V600-CA5D_100.inf* is saved.

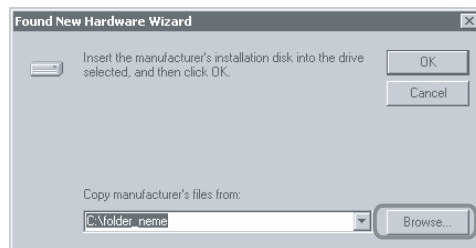

7. Click the **Next** Button.

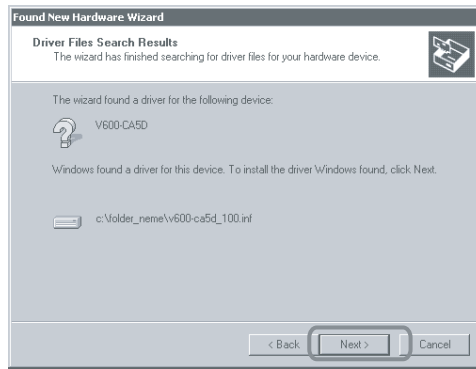

The following window will be displayed when software installation is completed.



8. Click the **Finish** Button.

■ Checking Installation

Check that the driver is correctly installed.

1. Connect the ID Controller to the personal computer using the USB interface.

2. On the Start Menu, select **Settings - Control Panel - System**.

3. Select the **Device Manager** Button on the Hardware Tab Page.

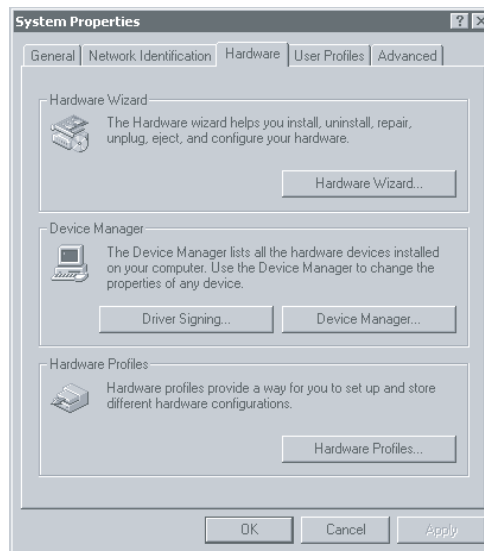

4. Select **Ports (COM & LPT)**, and confirm that **OMRON RFID USB COM** is displayed.
The driver is correctly installed if this port is displayed.

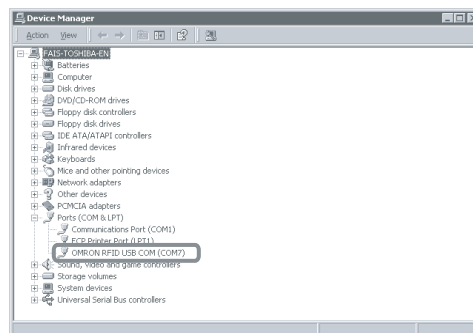

Communications with the ID Controller can be performed with the COM number displayed in parentheses after OMRON RFID USB COM.

Windows XP (SP1)

1. Turn ON the power to the personal computer and start Windows XP.

2. Connect the ID Controller to the personal computer using the USB interface.

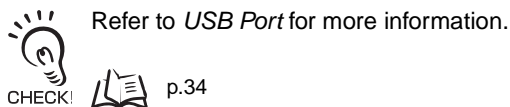

CHECK!  p.34

Wait for the following window to be displayed.

3. When the following window is displayed, select *Install from a list or specific location (Advanced)* and click the **Next** Button.

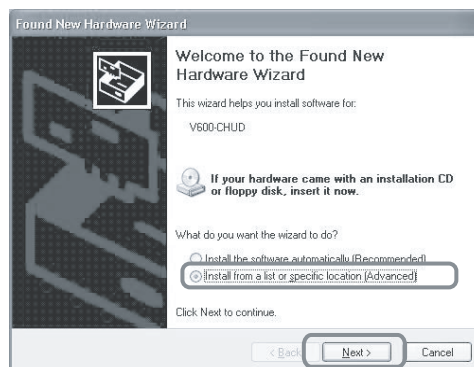

4. Click the **Browse** Button, select the folder in which the downloaded file *V600-CA5D_100.inf* is saved, and then click the **Next** Button.

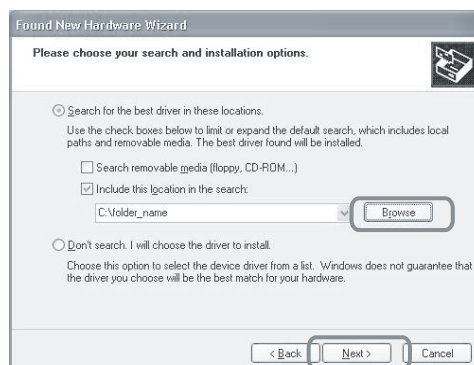

5. Click the **Continue Anyway** Button.

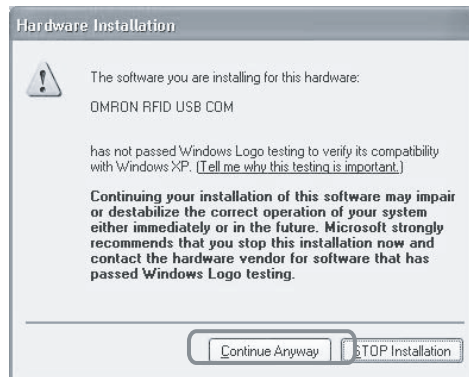

The following window will be displayed when software installation has been completed.

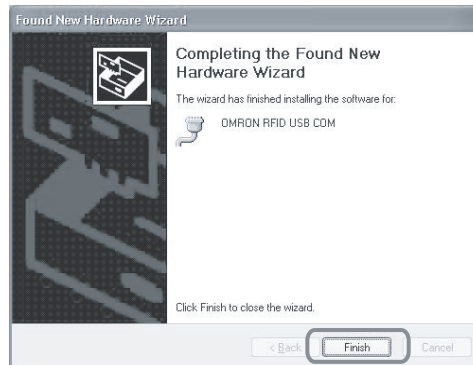

6. Click the **Finish** Button.

■ Checking Installation

Check that the driver is correctly installed.

-
1. Connect the ID Controller to the personal computer using the USB interface.
-

2. On the Start Menu, select **Control Panel - Performance and Maintenance**.
-

3. Select the **System** Icon.
-

4. Click the **Device Manager** Button on the Hardware Tab Page.

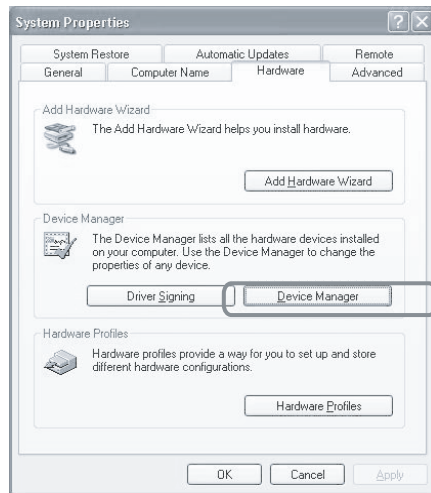

5. Select Ports (COM & LPT), and confirm that OMRON RFID USB COM is displayed.

The driver is correctly installed if this port is displayed.

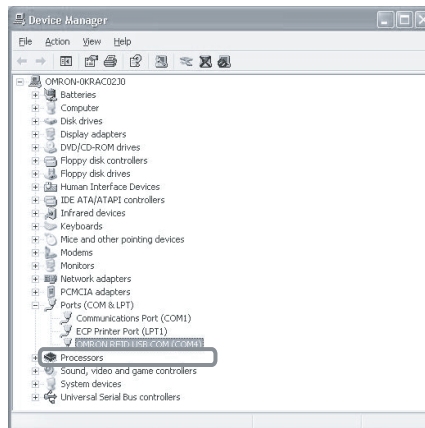

Communications with the ID Controller can be performed with the COM number displayed in parentheses after OMRON RFID USB COM.

Read/Write Head Connection Port

■ Inserting and Removing the Connector

1. Hold the rubber mold of the connector and insert the connector into the mating connector on the ID Controller.
2. Push the connector straight in until it is locked.



The connector will not lock if it is pushed while holding the ring. Be sure to hold the rubber mold.

CHECK!

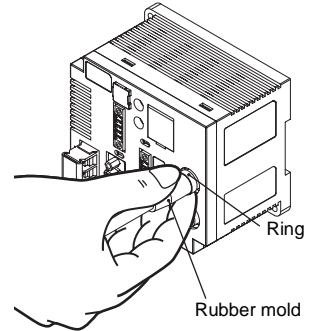

3. To remove the connector, pull it straight out while holding the ring.



The connector must not be pulled while holding the rubber mold. If an excessive force is applied to the cable, the cable may break or be damaged.

CHECK!

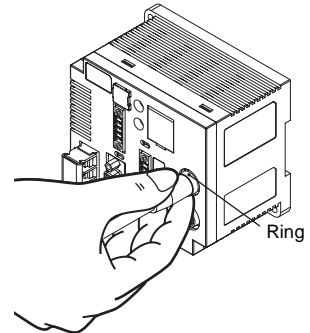

MEMO

Section 3

Preparing Communications

☒ Switch Settings	46
☒ Test Operation	55

Switch Settings

Opening the Cover

Insert the tip of a small flat-blade screwdriver into the notch in the cover and open the cover.

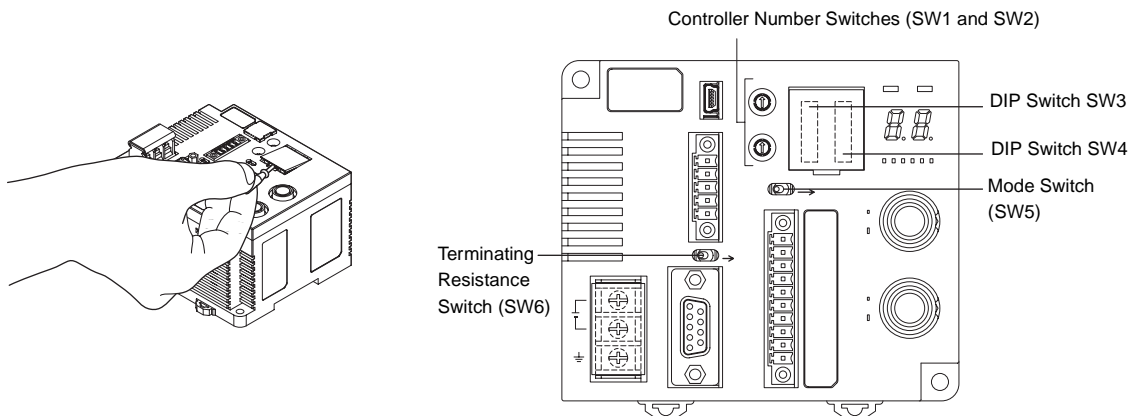

Setting the Switches

Set the switches as shown below.

- Rotary Switches (SW1 and SW2)

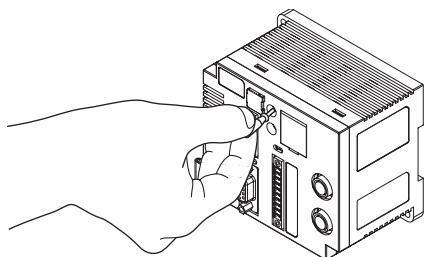

- DIP Switches (SW3 and SW4)

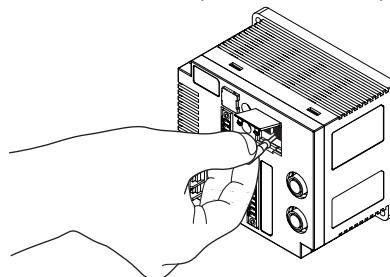

- Toggle Switches (SW5 and SW6)

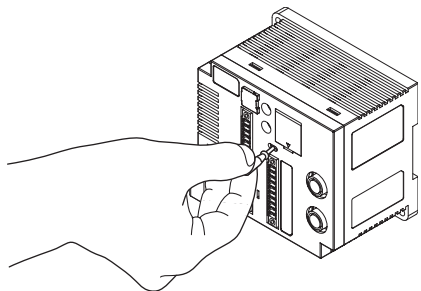

Factory Settings

	Name	Factory setting	Description	More information
SW1	Controller Number Switch 1 (Upper digit: 0 to 9)	0	Controller number 00	p.48
SW2	Controller Number Switch 2 (Lower digit: 0 to 9)	0		
SW3 pin 1	DIP switch/internal setting selector	OFF	DIP switches enabled	p.49
SW3 pin 2	Baud rate setting 1	OFF	Baud rate: 2,400 bps	
SW3 pin 3	Baud rate setting 2	OFF		
SW3 pin 4	Baud rate setting 3	OFF		
SW3 pin 5	Data length setting	OFF	Data length: 7 bits	
SW3 pin 6	Parity setting 1	OFF	Parity: Even	
SW3 pin 7	Parity setting 2	OFF		
SW3 pin 8	Stop bit setting	OFF	Stop bits: 2 bits	
SW3 pin 9	Communications protocol setting	OFF	1:1	
SW3 pin 10	Reserved.	OFF	Not used.	
SW4 pin 1	Priority mode switch	OFF	Communications distance priority	p.50
SW4 pin 2	Verify setting	OFF	Verification enabled	
SW4 pin 3	Display switch	OFF	End code display	
SW4 pin 4	Lower trigger execution	OFF	No lower trigger	
SW4 pin 5	Reserved.	OFF	Not used.	
SW4 pin 6	Test switch	OFF	Test stopped	
SW4 pin 7	Reserved.	OFF	Not used.	
SW4 pin 8	TEST head specification	OFF	Channel 1	
SW4 pin 9	TEST command specification	OFF	Read test	
SW4 pin 10	Reserved.	OFF	Not used.	
SW5	Mode switch	OFF	RUN mode	p.51
SW6	Terminating resistance switch	OFF	Terminating resistance not connected.	

■ Setting the Controller Number Switches (SW1 and SW2)

■ Controller Numbers

It is necessary to be able to distinguish between ID Controller when more than one ID Controller is connected to a single host device. Each ID Controller is assigned a controller number for this purpose. The controller number is included in commands and responses for 1:N communications. Communications will not be possible if the controller numbers are not set correctly.



SW1 and SW2 are enabled when SW3 pin 1 is OFF (DIP switches enabled). If SW3 pin 1 is ON (internal settings enabled), the controller numbers specified with the SP command are used.



■ Controller Number Switches

SW1	SW2	Controller number
Upper digit	Lower digit	
0	0	0
0	1	1
0	2	2
0	3	3
0	4	4
0	5	5
0	6	6
0	7	7
0	8	8
0	9	9
1	0	10
1	1	11
:	:	:
2	9	29
3	0	30
3	1	31
3	2	Do not set.
3	3	Do not set.
:	:	:
9	9	Do not set.

Setting Examples

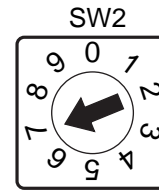
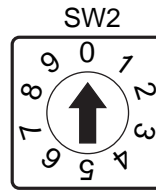
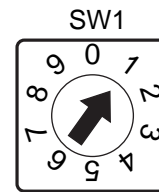
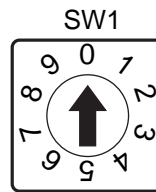

Controller Number 0

Controller Number 17

The controller number switches are factory-set to 00.



Do not set the controller number switches to between 32 and 99.

■ DIP Switches (SW3 and SW4)

■ SW3 Pin 1: DIP Switch/Internal Setting Selector

SW3 pin 1	Description
OFF	DIP switches enabled.
ON	Internal settings enabled.

Note: Switches SW1, SW2, SW3 pins 2 to 10, and SW4 pins 1 to 4 are enabled only when SW3 pin 1 is OFF (DIP switches enabled).



CHECK!

If the internal settings are enabled, settings made with the TR and SP commands are used. The default settings will be used until they are changed with the TR and SP commands.



p.126, p.128

■ SW3 Pins 2 to 4: Baud Rate Setting

SW3 pin 2	SW3 pin 3	SW3 pin 4	Description
OFF	OFF	OFF	2400 bps
OFF	OFF	ON	4800 bps
OFF	ON	OFF	9600 bps
OFF	ON	ON	19200 bps
ON	OFF	OFF	38400 bps
ON	OFF	ON	1200 bps
Other			2400 bps

■ SW3 Pin 5: Data Length Setting

SW3 pin 5	Description
OFF	7 bits
ON	8 bits

■ SW3 Pins 6 and 7: Parity Setting

SW3 pin 6	SW3 pin 7	Description
OFF	OFF	Even
OFF	ON	None
ON	OFF	Odd
ON	ON	Even

■ SW3 Pin 8: Stop Bit Setting

SW3 pin 8	Description
OFF	2 bits
ON	1 bit

■ SW3 Pin 9: Communications Protocol Setting

SW3 pin 9	Description
OFF	1:1
ON	1:N

■ SW3 Pin 10: Reserved.

Do not change the setting of this pin. Leave it set to OFF.

■ **SW4 Pin 1: Priority Mode Switch**

SW4 pin 1	Description
OFF	Communications Distance Priority Mode
ON	Communications Time Priority Mode

■ **SW4 Pin 2: Verify Setting**

SW4 pin 2	Description
OFF	Verification enabled.
ON	Verification disabled.

■ **SW4 Pin 3: Seven-segment Display Switch**

SW4 pin 3	Description
OFF	End code display
ON	I/O display

■ **SW4 Pin 4: Lower Trigger Execution Switch**

SW4 pin 4	Description
OFF	Disabled.
ON	Enable (rising edge)

■ **SW4 Pins 5, 7, and 10: Reserved.**

Do not change the settings of these pins. Leave them set to OFF.

■ **SW4 Pin 6: Test Switch**

SW4 pin 6	Description
OFF	Test stopped.
ON	Test executed.

Note: This switch is effective only in MAINTENANCE mode.

■ **SW4 Pin 8: TEST Head Specification**

SW4 pin 8	Description
OFF	Communicate with Read/Write Head 1.
ON	Communicate with Read/Write Head 2.

Note: This switch is effective only in MAINTENANCE mode.

■ **SW4 Pin 9: TEST Command Specification**

SW4 pin 9	Description
OFF	Use read test.
ON	Use write test.

Note: This switch is effective only in MAINTENANCE mode.

■ Setting the Mode Switch

SW5	Description
OFF	RUN mode
ON	MAINTENANCE mode

■ Setting the Terminating Resistance

When more than one ID Controller is connected in series to a single host device, the terminating resistance must be turned ON at the nodes (ID Controller or host device) on both ends of the main cable and turned OFF at the rest of the nodes. Operation will not be stable if the terminating resistance is not set correctly.

The terminating resistance switch connects and disconnects the built-in terminating resistance.

SW6	Description
OFF	Terminating resistance not connected.
ON	Terminating resistance connected.

Operating Modes

The ID Controller has two modes: RUN mode and MAINTENANCE mode.

■ RUN mode

In RUN mode, operation is performed according to commands from the host device and results are returned to the host device as responses.

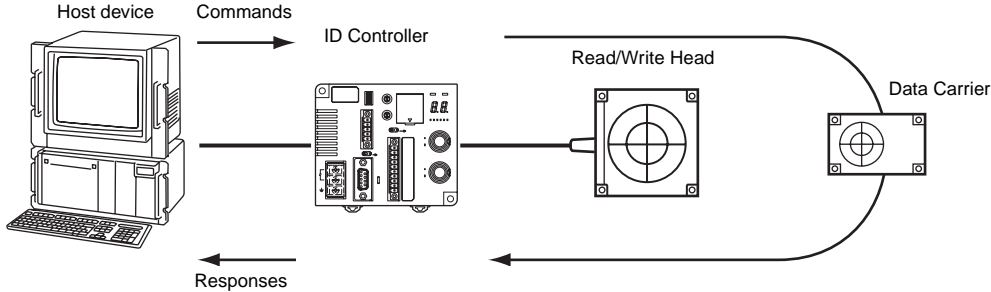

■ MAINTENANCE Mode

In MAINTENANCE mode, communications test with Data Carriers are performed offline. Communications with Data Carriers are repeated every 0.5 s. The COMM1/COMM2 indicator will flash during communications with a Data Carrier. When processing has been completed, the results will be displayed on the monitor display using end codes.

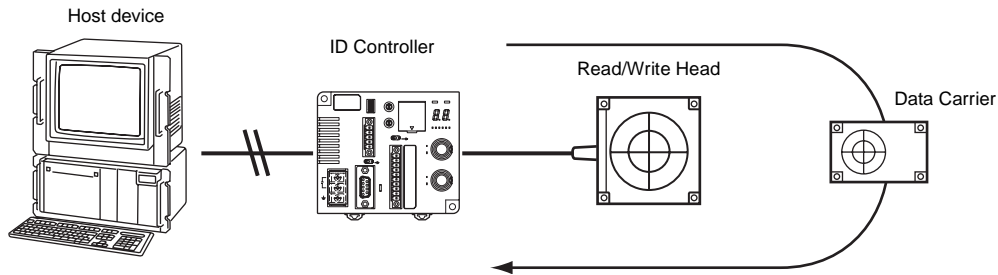

Both read tests and write tests can be performed in MAINTENANCE mode. In the read test, one byte of data is read repeatedly. In the write test, one byte of data is written repeatedly. The contents of the Data Carrier is not changed during a write test. Use these tests to check operation when installing a system.



Do not change the Data Carrier when executing tests in MAINTENANCE mode.

Write Command Memory

A write command executed by the ID Controller is recorded until either the next write command or until power is reset. The write commands include the WRITE, EXPANSION WRITE, AUTO WRITE, and POLLING AUTO WRITE commands. The recorded write command can be executed again by using the WRITE PROCESSING REPEAT command.

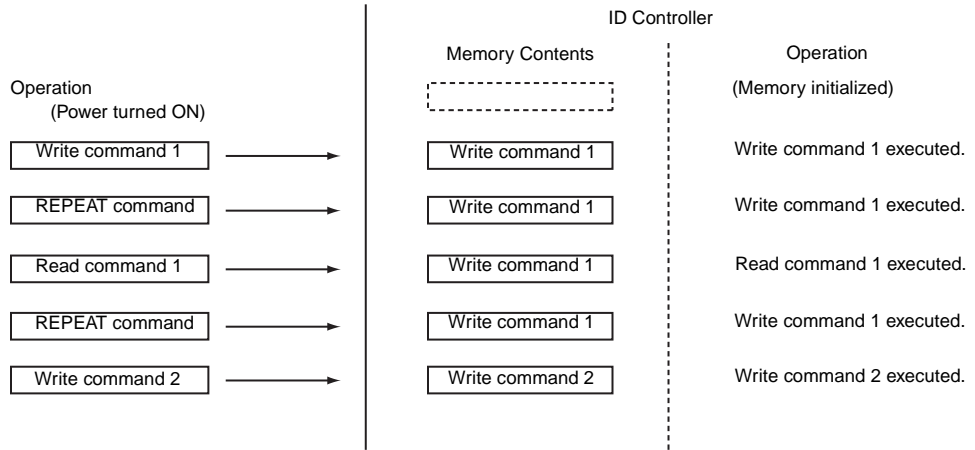

Trigger Input

The ID Controller is provided with two trigger inputs that inform the ID Controller when to start processing the Data Carrier. After receiving a command from the host device, the ID Controller will wait until the rising edge of the trigger input and then start communications with the Data Carrier.

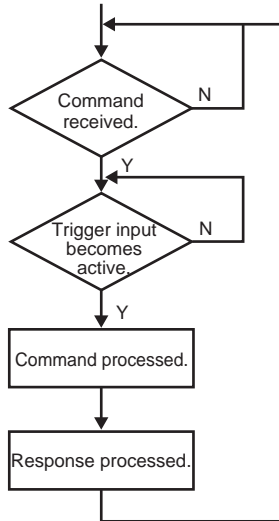

Note: Processing will not be aborted even if the status of the trigger input changes during processing.

For AUTO commands, the ID Controller will start waiting for a Data Carrier to approach after the trigger input is received. Therefore, read/write processing will not be performed until the trigger input is received even if a Data Carrier approached the ID Controller.

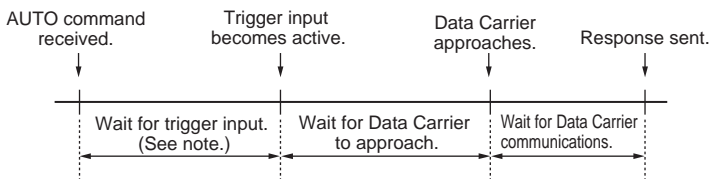

Note: Processing will not be performed while waiting for the trigger input even if a Data Carrier approaches.

Test Operation

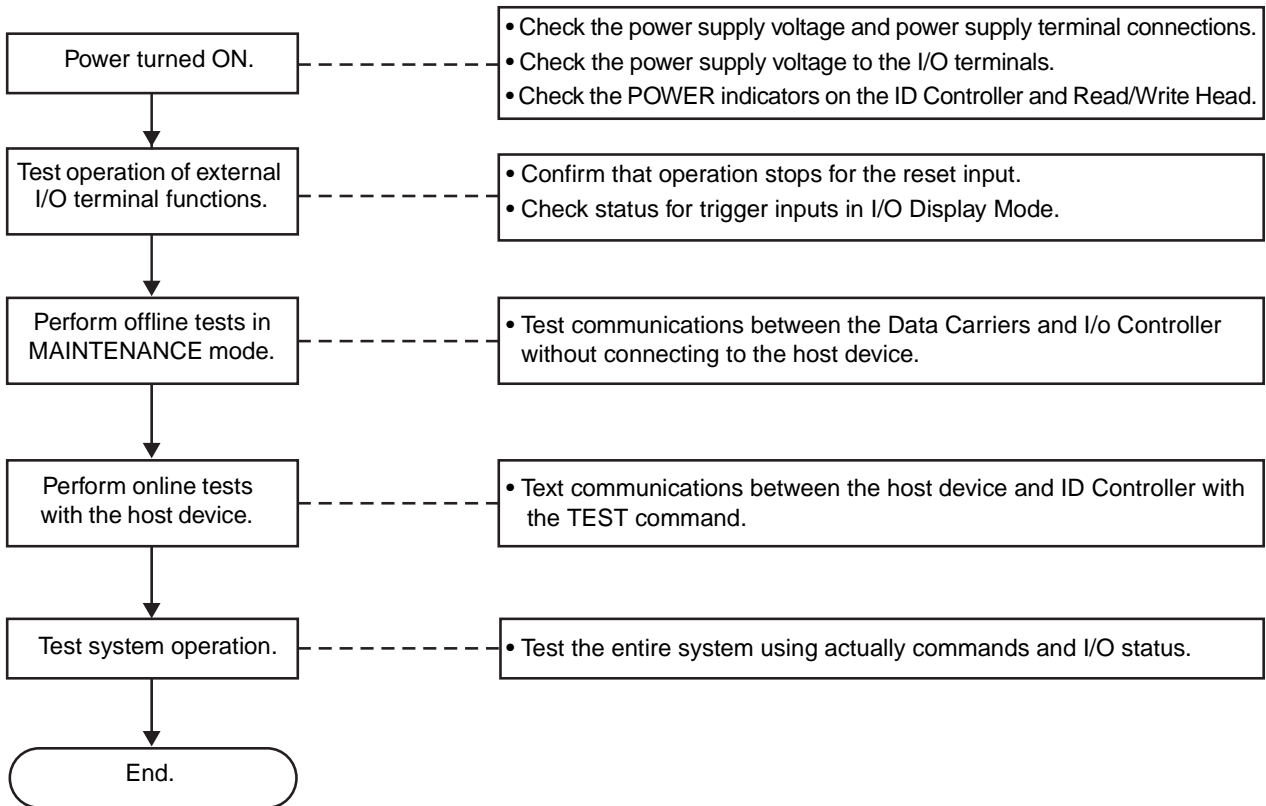

Offline Tests in MAINTENANCE Mode

In MAINTENANCE mode, communications between the ID Controller and Data Carriers can be tested without connecting to the host device.



Use offline testing to check installation positions before performing test operations.

Testing Host Device Communications

The TEST command can be used to test communications between the ID Controller and host device. This enables checking cable connections and communications processing before testing the operation of the entire system.

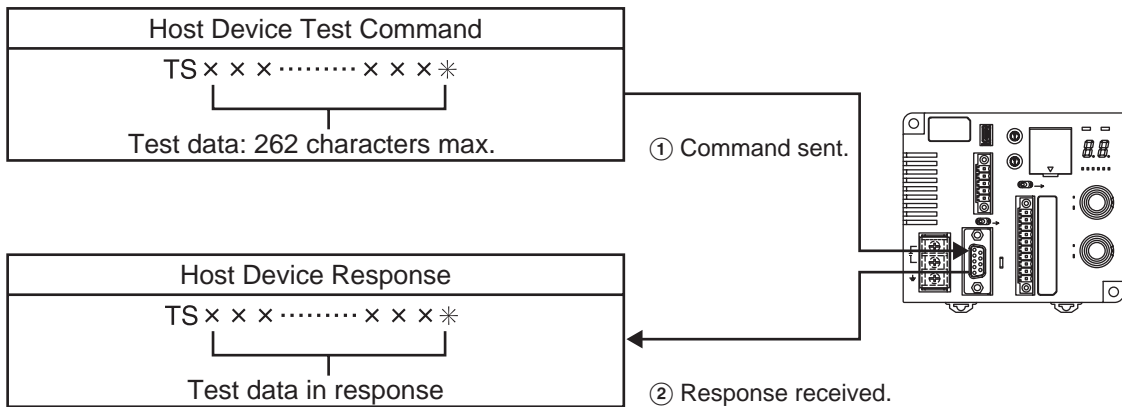
1. Create a simple communications program on the host device to send the TEST command (TS).
If communications function properly, the ID Controller will send back the received data.



 Refer to *TEST Command (TS)* for more information on the TEST command.
CHECK!  p.121

Example

The following command and response are for sending the test data "OMRON" to the ID Controller with controller number 2.

Command

Controller No.	Command code	Test data	FCS	Terminator
@ 0 2	T S	O M R O N	1 4	* CR
3	2	5	2	2

Response

Controller No.	Command code	Test data	FCS	Terminator
@ 0 2	T S	O M R O N	1 4	* CR
3	2	5	2	2

Section 4 Function

☒ Write Protect Function	58
☒ Data Carrier Service Life Detection	61
☒ Data Carrier Memory Check Function	64

Write Protect Function

The write protect function prevents important data stored in the Data Carrier, such as the product type and model, from being overwritten by other data and lost.

Use the following methods to set write protection after writing important data.

Data Carriers with Built-in Battery (V600-D□KR□□ and V600-D□KF□□)

Setting Write Protection Function

The write protect function is set in the four bytes of addresses 0002H through 0005H of the Data Carrier's memory.

The status of the most significant bit of address 0002H determines whether or not the write protect function is enabled.

Address \ Bit	7	6	5	4	3	2	1	0
0002H	Yes/No	Upper two digits of start address						
0003H	Lower two digits of start address							
0004H	Upper two digits of end address							
0005H	Lower two digits of end address							

- Write-protect Bit (most significant bit of address 0002H)

1: Data is write-protected
0: Data is not write-protected

- Write Protect Setting Area

Start address: 0006H to 1FFFH
End address: 0006H to 1FFFH

Settings to Write-protect Addresses 0006H through 07FFH

Address \ Bit	Upper digit				Lower digit			
0002H	1	0	0	0	0	0	0	0
	8				0			
0003H	0	0	0	0	0	1	1	0
	0				6			
0004H	0	0	0	0	0	1	1	1
	0				7			
0005H	1	1	1	1	1	1	1	1
	F				F			

Settings to Not Write-protect Addresses

Address \ Bit	Upper digit				Lower digit			
0002H	0	0	0	0	0	0	0	0
	0				0			
0003H	0	0	0	0	0	0	0	0
	0				0			
0004H	0	0	0	0	0	0	0	0
	0				0			
0005H	0	0	0	0	0	0	0	0
	0				0			

■ Setting Write Protection Function

■ Write Protection Setting Examples (2-Kbyte Memory Data Carrier)

(1) Settings to Write-protect Addresses 0015H to 0120H
(Start address < End address)

Address \ Bit	7	6	5	4	3	2	1	0	
0002H	1	0	0	0	0	0	0	0	(HEX)
	8				0				
0003H	0	0	0	1	0	1	0	1	
	1				5				
0004H	0	0	0	0	0	0	0	1	
	0				1				
0005H	0	0	1	0	0	0	0	0	
	2				0				

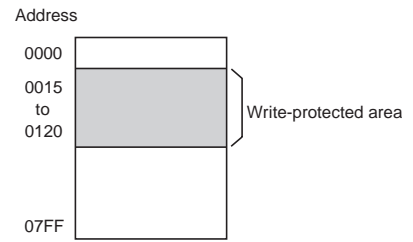

(2) Settings to Write-protect 1 Byte

(Start address = End address)

Specify the same address for the start and end addresses.

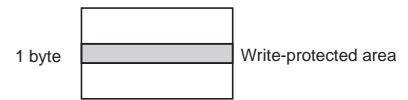

(3) Settings when the End Address Is Greater than the Final Address in the Data Carrier

(End address > 07FFH)

The Data Carrier memory area is from addresses 0000H to 07FFH. Therefore, the addresses up to 07FFH will be write-protected.

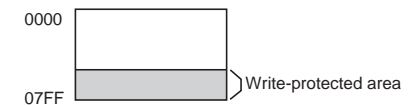

(4) Settings when the Start Address Is Greater than the End Address

(Start address > End address)

The area between 0006H and the end address and the area between the start address and 07FFH will be write-protected.

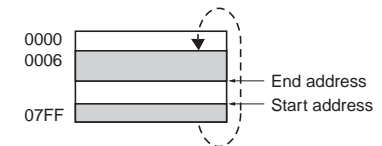

■ Canceling Write Protection

To cancel write protection, set the most significant bit of address 0002H to 0. The write protection will be cancelled, and the start and end addresses that are set in 0002H to 0005H will be ignored.



A lithium battery is built into SRAM Data Carriers with built-in batteries and may occasionally cause serious injury due to combustion, explosion, or burning. Dispose of the Product as industrial waste and never disassemble it, expose it to pressures that would distort it, heat it to temperatures above 100°C, or incinerate it.



Data Carriers without Batteries (V600-D23P□□)

Setting Write Protection Function

The write protect function is set by writing the final address to be protected in address 0000H of the Data Carrier's memory. The area between address 0001H and the write-protect end address will be write-protected.

The status of the most significant bit of address 0000H determines whether or not the write protect function is in effect.

Address \ Bit	7	6	5	4	3	2	1	0
0000	Yes/No	End address						

- Write-protect Bit (most significant bit of address 0000H)

1: Write-protected (Yes)

0: Not write-protected (No)

- End Address Setting Range

00H, 01H to 7FH

Addresses 0080H to 00FFH cannot be set as the end address. If the end address is set to 00H, however, all addresses from 0001H to 00FFH will be protected.

Write-protect Setting Examples (254-byte Memory Data Carrier)

- (1) The following settings would write-protect addresses 0001H through 0012H:

Address \ Bit	7	6	5	4	3	2	1	0
0000H	1	0	0	1	0	0	1	0
	9			2				

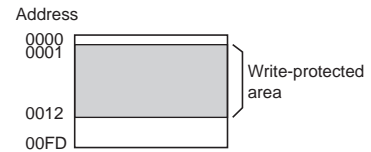

- (2) The entire memory except address 0000H is write protected by setting the end address to 00H, as shown below.

(Example: When the end address is 00H)

Address \ Bit	7	6	5	4	3	2	1	0
0000H	1	0	0	0	0	0	0	0
	8			0				

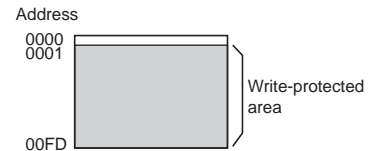

Canceling Write Protection

To cancel write protection, set the most significant bit of address 0000H to 0. The write protection will be cancelled, and the address set in 0000H will be ignored.



CHECK!

Address 0000H is the write protection setting area.

Therefore, always structure the data so that any data that needs to be write protected is written in addresses starting from 0001H.

Data Carrier Service Life Detection

Data Carriers with Built-in Battery (V600-D□KR□□ and V600-D□KF□□)

■ Checking If the Battery Is Low

- Data Carriers with Built-in Batteries (Excluding V600-D2KR16)

(1) A battery-low check for the Data Carrier can be performed only when special access is made.

The battery-low check is performed by running a fixed current through the internal circuit of the Data Carrier. If the battery-low check is performed every time access is made, battery power will be consumed.

It is recommended that this be included as a routine check, once a day, when creating system programs.

(2) The access method for performing a battery-low check is performed when the two bytes of data from addresses 0000H to 0001H is read.

Execute one of the following commands to perform a battery-low check.

Battery-low Check Commands

- a REPEAT command - - - - - RD H/A1 0000 02*CR
- b AUTO READ command - - - - - AR H/A1 0000 02*CR
- c POLLING AUTO READ command - - - - - PR H/A1 0000 02*CR

(3) Response for Low Battery

If the battery is low, 7B will be given in the end code section within the response format.

Example

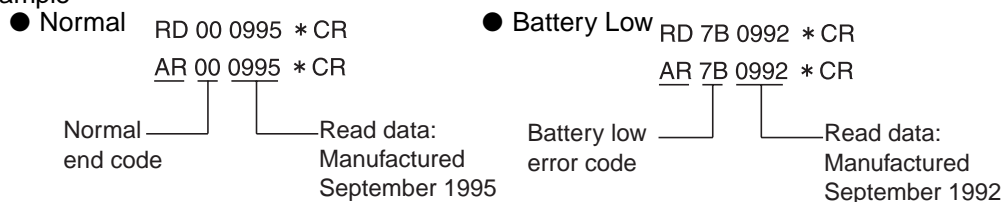

- A battery low check will be performed for V600-D2KR16 Data Carriers with replaceable batteries when read/write commands are executed, regardless of the addresses used.

■ Data Carrier Life after Low Battery Signal Occurs

- After a battery-low signal is sent, the Data Carrier can be used for approximately one month in the normal operating state. The Data Carrier should be replaced, however, as soon as possible.



The SRAM Data Carriers (except the V600-D2KR16) are equipped with a thionyl chloride lithium battery. A characteristic of the thionyl chloride lithium battery is that the internal resistance of the battery increases when the battery is left unused for several months. If this occurs and a Data Carrier battery-low check is performed, a low battery response may be returned regardless of whether battery life still remains. This is a result of the increased resistance within the battery, and is not due to the battery life expiring. If a Data Carrier has been left for several months after purchase without being used, use the read operation for approximately 10 minutes to activate the battery before use. (Current will flow in the battery and resistance in the battery will return to normal as a result of activating the battery. The life of the battery will hardly be affected.)

- When using V600-D2KR16 Data Carriers with replaceable batteries, the Data Carrier can be used for approximately two weeks in the normal operating state after the low battery signal is sent. The battery should be replaced, however, as soon as possible.



A lithium battery is built into SRAM Data Carriers with built-in batteries and may occasionally cause serious injury due to combustion, explosion, or burning. Dispose of the Product as industrial waste and never disassemble it, expose it to pressures that would distort it, heat it to temperatures above 100°C, or incinerate it.



Data Carriers without Batteries (V600-D23P□□)

MANAGEMENT DATA SUBTRACTION/LIMIT commands (MDS/MDL) can be used to determine whether the overwrite count for the EEPROM Data Carrier has been exceeded. By executing the MANAGEMENT DATA SUBTRACTION command (MDS), the number of overwrites is decremented from the data in the specified overwrite count control area, and whether the data has exceeded the limit is determined.

By executing the MANAGEMENT DATA LIMIT command (MDL), the number of overwrites is written to the data in the specified overwrite count control area, and whether the data has exceeded 100,000 writes is determined.

The MANAGEMENT DATA LIMIT command (MDL) is designed for Data Carriers without Batteries that have an expected life specification of 100,000 writes.

MDS Command

The overwrite count control area consists of 3 bytes from the start address. The decremented value of the overwrite count is written in this area, and if this value is 0 (00H) an end code of 76 will be returned as a warning. Therefore, to enable control of the number of overwrites, the maximum number of overwrites must be written to the overwrite count control area beforehand. The user-specified number of overwrites can be set to up to 16,700,000. The number of overwrites in the specifications for Data Carriers without batteries, however, is 300,000 overwrites (0493E0H) at 40°C max., so be sure to set the number of overwrites to 300,000 or lower.

The number of overwrites is controlled using hexadecimal values.

The current value can be read using the READ command.

If the control area data is already 0, the control area value will not be refreshed, and only a warning will be returned as a response.

When the refresh count is set as 00H, the count will not be updated, and only an overwrite count check will be performed.

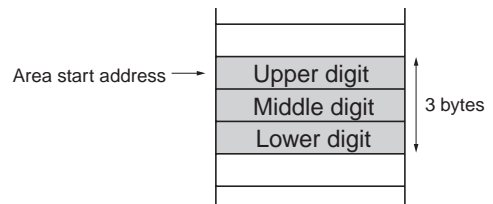

CHECK!

Set the start address to between □□□0H and □□□5H or between □□□8H and □□□DH. If the start address is set between □□□6H and □□□7H or between □□□EH and □□□FH, an address error (error code: 7A hexadecimal) will be returned as the end code.



CHECK!

For details on command format, refer to *MANAGEMENT DATA SUBTRACTION/LIMIT (MDS/MDL)*.

p.114

Application Example for MANAGEMENT DATA SUBTRACTION (MDS)

Using the Three Bytes from Address 0010H as the Overwrite Count Area

1. An overwrite count initial value of 100,000 times is written in the control area.
"WTH100100186A0"
2. Enter an overwrite count of 5. "MDS1001005"
A total of 5 times will be decremented from 100,000.

0010	01H
0011	86H
0012	A0H

0010	01H
0011	86H
0012	9BH

3. The accumulated count is 100,000 times.
When "MDS1001000" is executed, "MD76" will be returned (overwrite count exceeded).

0010	00H
0011	00H
0012	00H

MDL Command

The overwrite count control area consists of 3 bytes from the start address. The incremented value of the overwrite count is written in this area, and if this value is 100,000 (0186A0H) an end code of 76 will be returned as a warning.

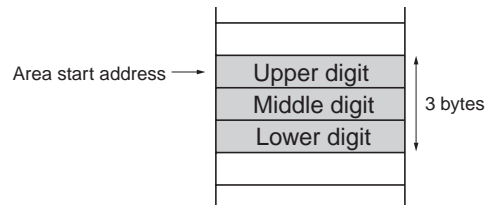

The number of overwrites is controlled using hexadecimal values.

The current value can be read using the READ command.

If the control area data is already 100,000, the control area value will not be refreshed, and only a warning will be returned as a response.

When the refresh count is set as 00H, the count will not be updated, and only an overwrite count check will be performed.



Set the start address to between $\square\square\square0H$ and $\square\square\square5H$ or between $\square\square\square8H$ and $\square\square\squareDH$. If the start address is set between $\square\square\square6H$ and $\square\square\square7H$ or between $\square\square\squareEH$ and $\square\square\squareFH$, an address error (error code: 7A hexadecimal) will be returned as the end code.



For details on command format, refer to *MANAGEMENT DATA SUBTRACTION/LIMIT (MDS/MDL)*.
CHECK!  p.114

Application Example for MANAGEMENT DATA LIMIT (MDL)

Using the Three Bytes from Address 0010H as the Overwrite Count Area

- The overwrite count area is cleared. "WTH1001000000" is executed.
- Enter an overwrite count of 4. "MDL1001004"

0010	00H
0011	00H
0012	00H

0010	00H
0011	00H
0012	04H

- Enter an overwrite count of 5. "MDL1001005"
The value will be added, making the count 9.
- The accumulated count is 100,000 times. When "MDL1001000" is executed, the "MD76" will be returned (overwrite count exceeded).

0010	00H
0011	00H
0012	09H

0010	01H
0011	86H
0012	A0H



Do not use both the MDS and MDL commands for the same Data Carrier. Doing so will prevent overwrite management.
Overwrite Life of Data Carriers without Batteries
Number of overwrites with an ambient temperature between the minimum temperature and 70°C: 100,000
Number of overwrites with an ambient temperature between the minimum temperature and +40°C: 300,000

Data Carrier Memory Check Function

A memory check can be made using the MANAGEMENT DATA CHECK/CALCULATE commands (MDC/MDK). A CRC (Cyclic Redundancy Check) code calculation, overwrite, and comparison are made, using the check block unit specified by the user. The CRC code is calculated from the generated polynomial expression $x^{16} + x^{12} + x^5 + 1$.

The calculation area is the portion of the check block specified by the start address and the number of bytes excluding the last two bytes. The last two bytes are the check code area.

When check code write is specified (transaction code: K), the CRC of the calculation area data is calculated and written to the check code area. When data comparison is specified (transaction code: C), the CRC of the calculation area data is calculated and a comparison made with the check code area data. If they coincide, end code 00 is returned, indicating normal transmission, and if they do not coincide, end code 76 is returned as a warning.

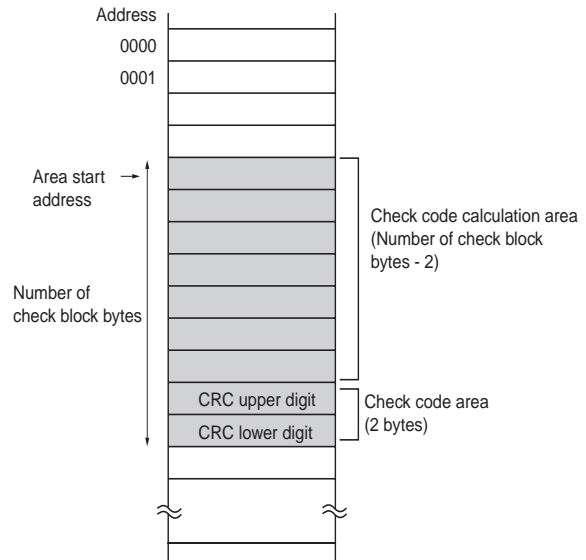

 For details on the command format, refer to *MANAGEMENT DATA CHECK/CALCULATE (MDC/MDK)*.

CHECK!  p.112

Example Using MANAGEMENT DATA CHECK/CALCULATE (MDC/MDK)

In the following example, the data in addresses 0010H to 0012H is checked.

- In this example, the following data already exists in the memory.
- Execute MDK1001005 (CRC calculated). The CRC code 5CD6 calculated from the data 123456 is written to addresses 0013H and 0014H.

0010	12H
0011	34H
0012	56H
0013	
0014	

0010	12H
0011	34H
0012	56H
0013	5CH
0014	D6H

- Execute MDC1001005 (CRC compared).

The normal response MD75 will be returned if the data coincides. If a data error occurs, MD76 (a data error warning) will be returned.

0010	12H
0011	34H
0012	56H
0013	5CH
0014	D6H

0010	00H	← Data error
0011	34H	
0012	56H	
0013	5CH	
0014	D6H	

Section 5

Communications

☒ Movement of Data Carriers and Command Status	66
☒ Command Format	71
☒ Communications Commands	76
☒ General Communications Subcommands	118
☒ Host Device Commands	121
☒ Other Commands	132
☒ End Codes	133

Movement of Data Carriers and Command Status

Communications Control Protocol

The host device communications control protocol conforms to the OMRON SYSWAY protocol.

- (1) Initially the host device has the right to send. When the host device sends a command, the right to send is transferred to the ID Controller.
- (2) When the ID Controller returns a response, the right to send is transferred back to the host device.
- (3) The right to send is transferred on a carriage return.
- (4) The SYSWAY protocol supports both 1:1 and 1:N communications.
- (5) The 1:N communications are used when more than one ID Controller is connected to a single host device. Up to 32 ID Controllers can be connected. Each command and response begins with a controller number to identify the ID Controller. A horizontal parity check is performed as a frame check sequence (FCS) to ensure robust error detection.
- (6) The 1:1 communications are used when one ID Controller is connected to one host device. To simplify procedures, a horizontal parity check is not performed.
- (7) Even when using a 1:1 connection, 1:N communications can be set (i.e., $N = 1$). If 1:N communications are set, always implement a horizontal parity check even if the connection is only 1:1.

Description

1. The host device send commands to the ID Controller.
2. The ID Controller analyzes the commands from the host device, executes communications with the Data Carriers, and writes/reads data to/from the Data Carriers.
3. When a read command is executed, the ID Controller sends the data it has read in a response to the host device. When a write command is executed, the Controller send a response indicating the end of processing to the host device.

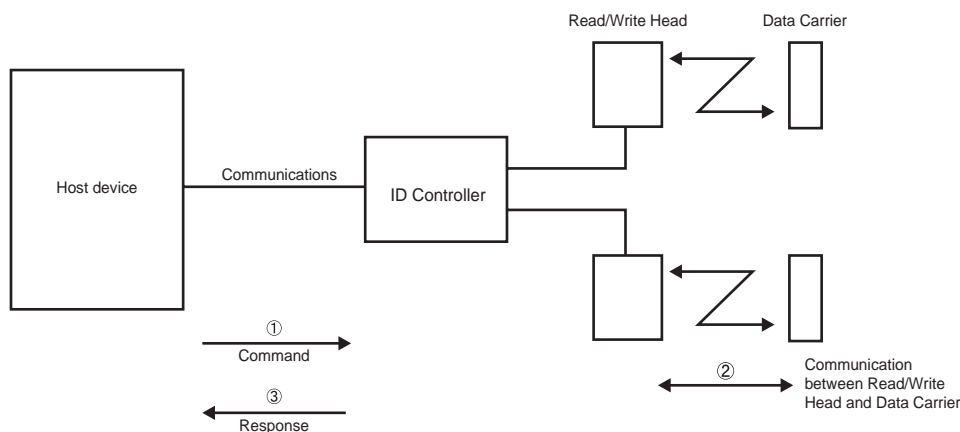

Command Reception Status

The ID Controller can have the following status for commands sent from the host device.

■ Command Wait Status

The ID Controller is in Command Wait Status when it is currently processing no command and is ready to receive any command from the host device.

■ Command Processing Status

The ID Controller is in Command Processing Status from when it receives a read/write (including expansion) or auto read/write command until it completes processing the command and returns a response to the host device.

While the ID Controller is in this status, it will receive only a COMMAND PROCESSING TERMINATE or ABORT command.

■ Polling Auto Subcommand Wait Status

The Polling Auto Subcommand Wait Status occurs at the following times after the ID Controller has received a Polling Auto Command:

- (1) From the time processing with the Data Carrier has been completed until the Controller returns the result of the processing in a response to a Check Polling Processing Subcommand.
- (2) Until processing by the ID Controller can be canceled by a End Polling Processing Subcommand from the host device.

When the ID Controller is in Polling Auto Subcommand Wait Status, it can receive only a Polling Subcommand (Check or End) or an ABORT command.

Read/Write Functions

Read/Write Command Processing

The read/write function is used for communications when the Data Carrier is motionless. Therefore, always be sure that the Data Carrier is at the specified position, i.e., in the communications area of the Read/Write Head. If the Data Carrier is missing, the ID Controller will return a response with an error code of 72 (Data Carrier missing).

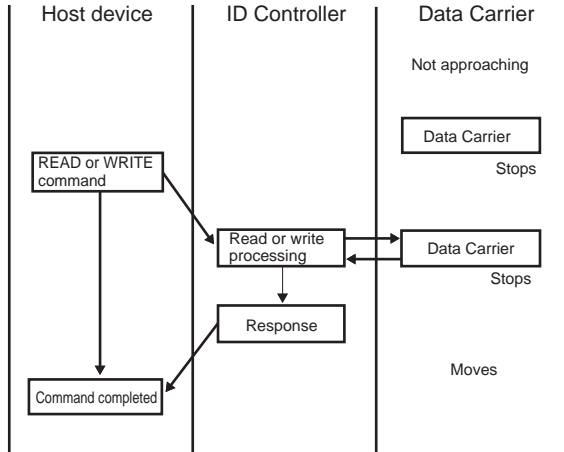

1. The host device confirms that a Data Carrier is at the specified position and then sends a command to the ID Controller.
2. The ID Controller performs write or read processing according to the command.
3. After the processing has been completed, the ID Controller returns a response to the host device to indicate that the processing has ended. The host device, upon receiving the response, moves the workpiece (with the Data Carrier) on the line.

Auto Read/Write Functions

Auto Command Processing

When the ID Controller has received an Auto Command, it does not send a response to the host device until the Data Carrier approaches. The communications line between the Controller and the host device will be busy until a Data Carrier approaches.

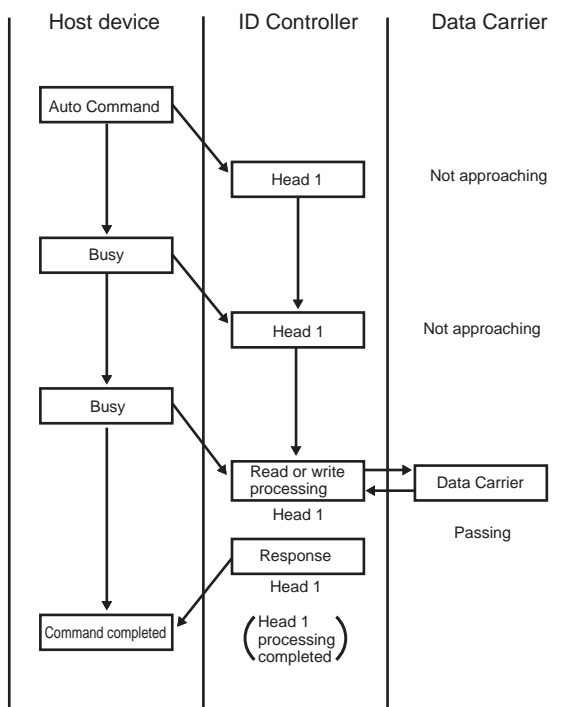

1. The host device sends an Auto Command to the Read/Write Head.
2. The ID Controller does not respond to the host device until the Data Carrier approaches, and only at this time does the host device become busy.
3. When a Data Carrier passes by the Read/Write Head, data is read or written.
4. After processing has been completed, the ID Controller returns a response to the host device to indicating the end of processing.

Using the AUTO READ and AUTO WRITE Commands

The READ and WRITE commands are normally used when Data Carriers are stopped.
The Auto Commands are normally used when Data Carriers are moving.

● READ or WRITE Command

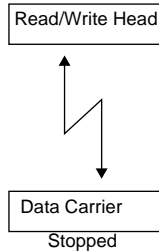

- A much wider communications area can be used to ensure dependable communications in comparison with moving Data Carriers.

● AUTO READ or AUTO WRITE Command

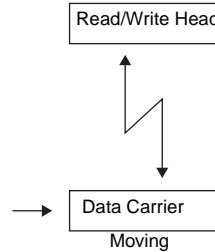

- When using Auto Commands, the approach of Data Carriers is automatically detected.
- If the Data Carriers are moving slowly enough and positioning is dependable enough, then there are few restrictions on the communications distance.

● Command Application Examples.

Item	Application method	Description	Precautions
Sending commands using a timer	<p>The next Auto Command is sent after receiving a response.</p>	<ul style="list-style-type: none"> • This method is applicable when Data Carriers pass through the communications area of the Read/Write Head at fixed intervals. • It can also be used when a long time elapses before next Data Carrier arrives. • Repeating the same communication with the same Data Carrier can be prevented if the waiting time during which the Data Carrier leaves the communications area elapses after the end of the communication. 	<ul style="list-style-type: none"> • Transportation speed must be kept constant. • This method is valid only for systems where communications are not performed more than once with same Data Carrier.
Trigger	<p>The next Auto Command is sent when a trigger is received after a response is returned.</p>	<ul style="list-style-type: none"> • For example, an Auto Command is transmitted after end of processing for the previous process has been confirmed. • The trigger must be input before the next Data Carrier approaches. 	<ul style="list-style-type: none"> • Trigger processing is necessary.

Polling

This section describes command processing when two Read/Write Heads are connected to one ID Controller. For normal Auto Commands, the ID Controller does not return a response until the Data Carrier approaches the specified Read/Write Head. This means that the communications path with the host device remains in the Busy Status, and the host device cannot send commands to the ID Controller's other Read/Write Head.

However, Polling Auto Commands enable the ID Controller to return a response when requested by the host device. Thus, the Busy Status of the communications path to the host device is cleared and the host device can send commands to the ID Controller's other Read/Write Head.

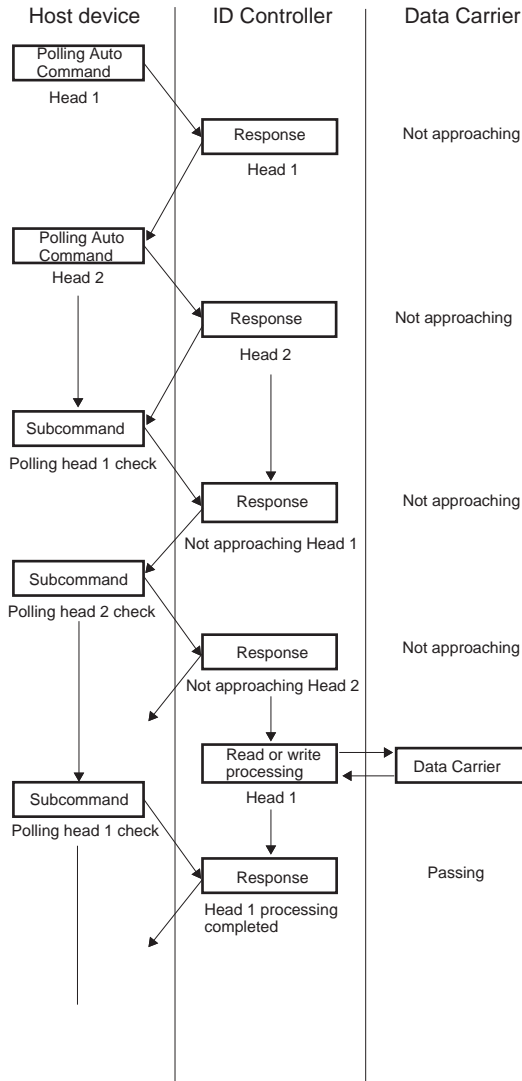

1. A Polling Auto Command is sent to Head 1.
2. The ID Controller receives the command and returns a response indicating that it has received the command.
3. A Polling Auto Command is sent to Head 2.
4. The ID Controller receives the command and returns a response indicating that it has received the command.
5. The host device can check the status of processing or end polling auto processing using subcommands.
6. When a Data Carrier is not close to the specified Read/Write Head, a "no Data Carrier" response is returned in response to a check subcommand.
7. When a Data Carrier passes by the Read/Write Head, data is read or written.
8. Once processing has been completed, the ID Controller sends a response to the host device indicating that the processing indicated by the check subcommand has been completed.

Command Format

Command and Response Formats

This section describes the format of commands sent from the host device to the ID Controller and the format of responses returned to the host device.

1:1 Communications

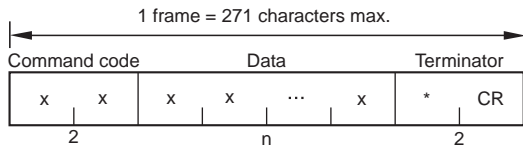

1:N Communications

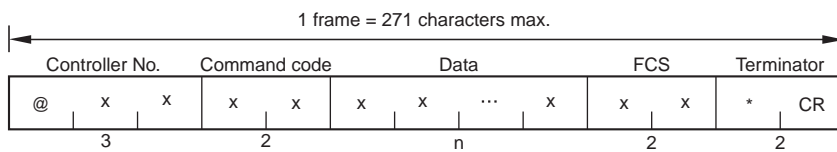

The controller number is specified as a decimal value. The specification range is @00 to @31.

Name	Description
Command code	Two characters indicating the command. The same two characters are returned in the response to the command.
Data	The details of the command or response is sent as the data. <ul style="list-style-type: none"> •The data specifies the following: ASCII/hexadecimal, processing, and modes. •The data specified the Read/Write Head to send to and the channel. •The data specifies the area start address. •The data specifies the number of bytes to read or write.
Terminator	The terminator indicates the end of the command or response.
Controller No.	With 1:N communications, the controller number (00 to 31) preceded by the at mark (@) must be added as a decimal value.
FCS (See note.)	With 1:N communications, horizontal parity check data must be added.

Note: Refer to *FCS Calculation Example* for a calculation program for the frame check sequence (FCS).



For Expansion Commands, any command longer than 266 characters or any response longer than 256 characters is divided into multiple frames for communications. Only the last frame is sent with a terminator (*CR); all other frames are sent with a delimiter (CR).

1. Responses Longer than 256 Characters (EXPANSION READ Command)

When the ID Controller sends a response frame that is not the last frame, the host device returns a delimiter (CR). When the ID Controller receives the delimiter, it sends the next response frame.

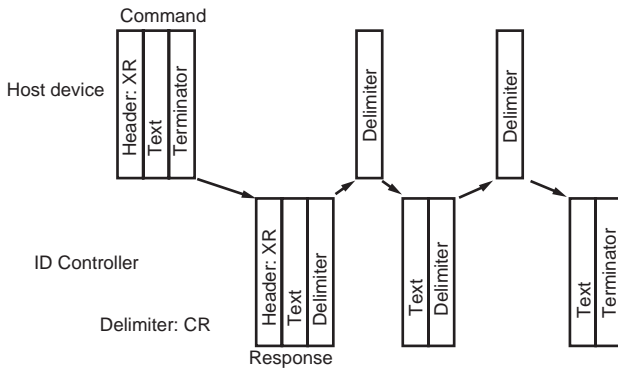

2. Commands Longer than 266 Characters (EXPANSION WRITE Command)

When the ID Controller receives a command frame that is not the last command frame, it returns a delimiter (CR) to the host device. The ID Controller can then receive the next command frame.

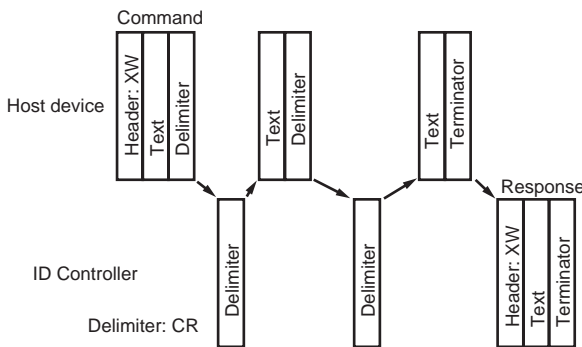

3. For the EXPANDED READ Command, responses for any command reading more than 240 characters are divided into multiple frames as shown below. Only the last frame is sent with a terminator (*CR); all other frames are sent with a delimiter (CR).

Response frames are sent with a 20 ms (default) interval between them.

The send interval can be changed with the SET PARAMETER (SP) command.

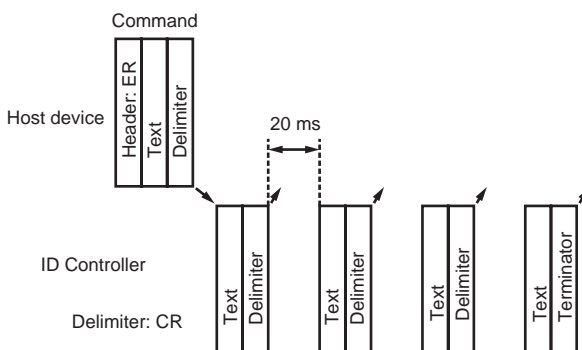

Data Code Specifications

Whether the read or write data is treated as ASCII (or JIS 8 code) or hexadecimal values is specified in the command.

■ ASCII (JIS 8 Code)

- One character of ASCII (JIS 8 code) data occupies 1 byte (1 address) of Data Carrier memory.

• Data Carrier

Address			
0010	4	F	"O"
0011	4	D	"M"
0012	5	2	"R"
0013	4	F	"O"
0014	4	E	"N"
	← 1 byte →		

• ASCII Data Code Specification Example for 1:1 Communications

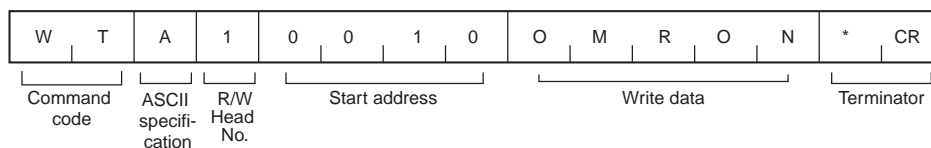

• ASCII Data Code Specification Example for 1:N Communications

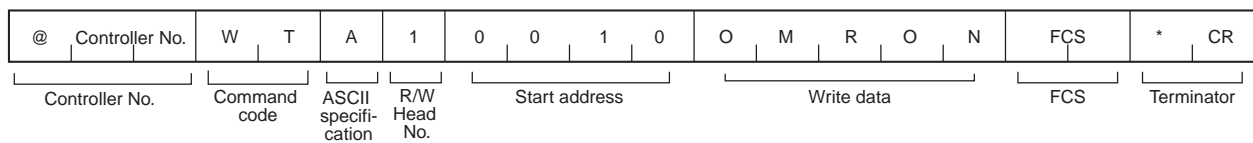

■ Hexadecimal Code

- One character is treated as a hexadecimal number. Therefore, only numerals 0 through 9 and A to F can be accepted.
- Two characters of data occupy 1 byte (1 address) of Data Carrier memory. Therefore, specify data in 2-character units (in even numbers) when using a Write Command. If an odd number of characters is specified by mistake, an error will occur.

• Data Carrier

Address			
0010	1	9	
0011	9	6	
	← 1 byte →		

• Hexadecimal Code Specification Example for 1:1 Communications

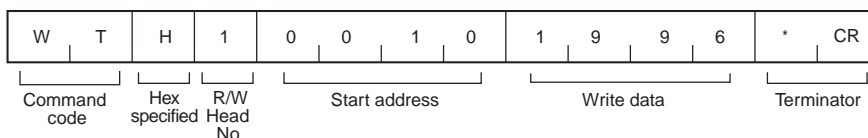

• Hexadecimal Code Specification Example for 1:N Communications

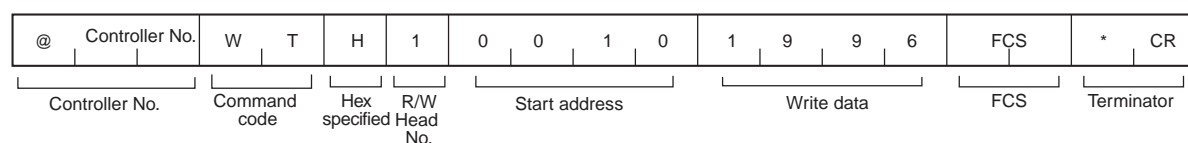

Command List

There are four major groups of commands.

■ Communications Commands

Communications Commands perform communications with Data Carriers.

Command code	Name	Description	More information
RD	READ	Reads Data Carrier memory.	p.76
WT	WRITE	Writes Data Carrier memory.	p.78
XR	EXPANSION READ	Reads up to 2 KB of Data Carrier memory data by dividing the data into frames.	p.80
XW	EXPANSION WRITE	Writes up to 2 KB of Data Carrier memory data by dividing the data into frames.	p.84
ER	EXPANDED READ	Reads up to 8 KB of Data Carrier memory data.	p.88
AR	AUTO READ	Waits for a Data Carrier to approach and then reads Data Carrier memory.	p.91
AW	AUTO WRITE	Waits for a Data Carrier to approach and then writes Data Carrier memory.	p.93
DF	DATA FILL	Fills Data Carrier memory with the specified number of write bytes from the start write address specified in the command.	p.95
AF	AUTO DATA FILL	Waits for a Data Carrier to approach and then fills Data Carrier memory with the specified number of write bytes from the start write address specified in the command.	p.98
CP	COPY	Writes data read from Data Carrier memory by one Read/Write Head to the memory of a Data Carrier in the communications area of the other Read/Write Head.	p.100
AP	AUTO COPY	Waits until a Data Carrier approaches and then Writes data read from Data Carrier memory by one Read/Write Head to the memory of a Data Carrier in the communications area of the other Read/Write Head.	p.102
PR	POLLING AUTO READ	Waits for a Data Carrier to approach and then reads Data Carrier memory. Command processing results can be checked using a subcommand.	p.104
PW	POLLING AUTO WRITE	Waits for a Data Carrier to approach and then writes Data Carrier memory. Command processing results can be checked using a subcommand.	p.108
MDC/MDK	MANAGEMENT DATA CHECK and MANAGEMENT DATA CALCULATE	Used to calculate and verify check codes in Data Carrier memory.	p.112
MDS/MDL	MANAGEMENT DATA SUBTRACTION and MANAGEMENT DATA LIMIT	Used to manage the number of times memory in a Data Carrier without a battery is overwritten.	p.114
RP	WRITE REPEAT	Executes the most recently executed Write Command.	p.116

■ General Communications Subcommands

These subcommands are used to cancel or abort command execution.

Command code	Name	Description	More information
AA	COMMAND PROCESSING TERMINATE	Terminates communications with the Data Carrier.	p.118
XZ	ABORT	Restores the initialization status of ID Controller, i.e., the status immediately after power is turned ON. No response will be returned. Do not use the abort command while communicating with a Data Carrier.	p.120

Host Device Commands

Host Device Commands are used to control the ID Controller.

Command code	Name	Description	More information
TS	TEST	Used to check communications between the ID Controller and the host device. Returns the test message sent from the host device without any changes.	p.121
CC	CONTROLLER CONTROL	Used to manipulate user I/O.	p.122
CF	ERROR READ	Reads the error log.	p.124
TR	COMMUNICATIONS CONDITIONS SETTING	Sets conditions for serial communications.	p.126
SP	PARAMETER SETTING	Sets, reads, and initializes ID Controller parameters.	p.128

FCS Calculation Example

Calculating the FCS for a 5-byte Read from Address 0010H

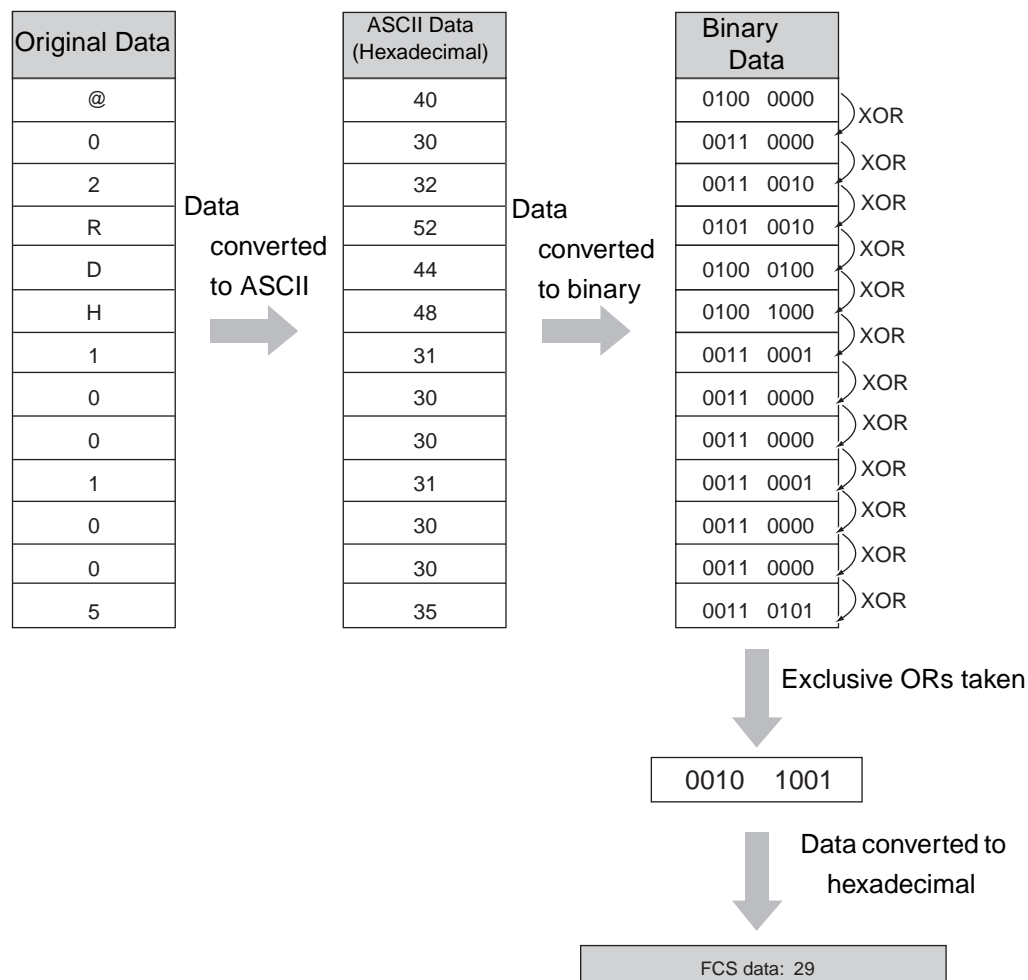

Communications Commands

The commands used to perform communications with Data Carriers are described in this section.

READ (RD)

For READ the ID Controller reads data from Data Carrier memory. If there is no Data Carrier in the communications area, an error response with an error code of 72 (Data Carrier missing) will be returned.

1:1 Communications

Command

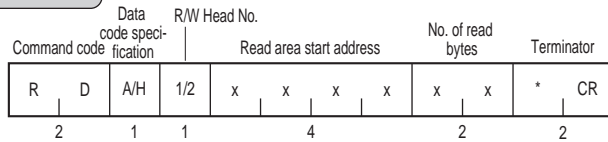

Data code specification	Specifies the type of code in which to send the read data in the response. A: ASCII H: Hexadecimal
R/W Head No.	Specifies the Read/Write Head with which to communicate. 1: Read/Write Head 1 2: Read/Write Head 2
Read area start address	Specifies the first address from which to read data from the Data Carrier as a four-digit hexadecimal number. Specifiable range: 0000H to FFFFH
No. of read bytes	Specifies the number of bytes of data to read from the Data Carrier as a two-digit hexadecimal number. Up to 256 bytes can be read with one command. Specifiable range: 00H to FFH (The maximum of 256 bytes will be read if 00H is specified.) • ASCII specification: 256 bytes (256 characters) • Hexadecimal code specification: 256 bytes (512 characters)

Response

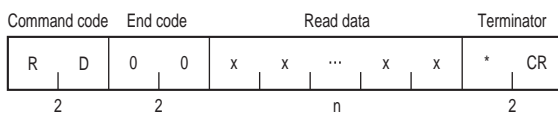

End code	Indicates the results of command execution. An end code of 00 is returned for a normal end. Refer to <i>End Codes</i> for more information.  p.133
Read data	The data read from Data Carrier memory. The number of characters will be the same as the number of read bytes for ASCII data and twice the number of read bytes for hexadecimal data.

■ 1:N Communications

Command

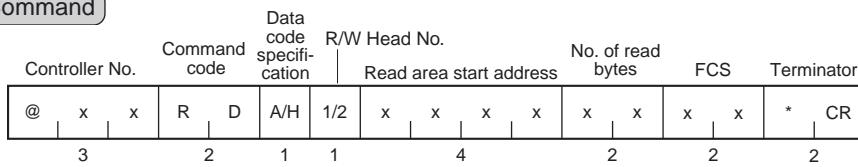

Data code specification	Specifies the type of code in which to send the read data in the response. A: ASCII H: Hexadecimal
R/W Head No.	Specifies the Read/Write Head with which to communicate. 1: Read/Write Head 1 2: Read/Write Head 2
Read area start address	Specifies the first address from which to read data from the Data Carrier as a four-digit hexadecimal number. Specifiable range: 0000H to FFFFH
No. of read bytes	Specifies the number of bytes of data to read from the Data Carrier as a two-digit hexadecimal number. Up to 256 bytes can be read with one command. <ul style="list-style-type: none"> • ASCII specification: 256 bytes (256 characters) • Hexadecimal code specification: 256 bytes (512 characters) Specifiable range: 00H to FFH (The maximum of 256 bytes will be read if 00H is specified.)

Response

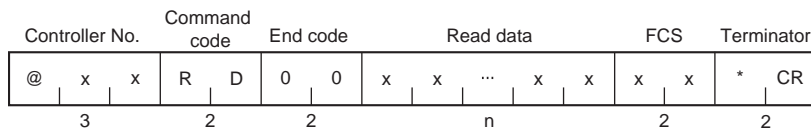

End code	Indicates the results of command execution. An end code of 00 is returned for a normal end. Refer to <i>End Codes</i> for more information.  p.133
Read data	The data read from Data Carrier memory. The number of characters will be the same as the number of read bytes for ASCII data and twice the number of read bytes for hexadecimal data.

WRITE (WT)

For WRITE, the ID Controller writes data to Data Carrier memory. If there is no Data Carrier in the communications area, an error response with an error code of 72 (Data Carrier missing) will be returned.

1:1 Communications

Command

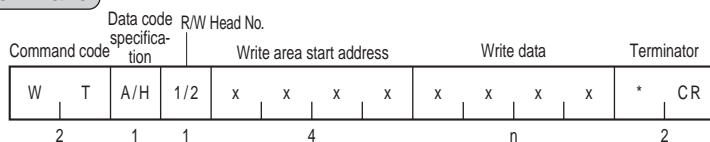

Data code specification	Specifies the type of code in which the write data is being sent. A: ASCII H: Hexadecimal
R/W Head No.	Specifies the Read/Write Head with which to communicate. 1: Read/Write Head 1 2: Read/Write Head 2
Write area start address	Specifies the first address to which to write data to the Data Carrier as a four-digit hexadecimal number. Specifiable range: 0000H to FFFFH
Write data	The data to write to Data Carrier memory. Up to 256 bytes can be written with one command. <ul style="list-style-type: none"> • ASCII specification: 256 bytes (256 characters) • Hexadecimal code specification: 256 bytes (512 characters) Note: When using hexadecimal code, set two characters for each byte.

Response

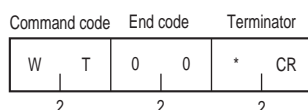

End code	Indicates the results of command execution. An end code of 00 is returned for a normal end. Refer to <i>End Codes</i> for more information.  p.133
----------	---------------------------------------------------------------------------------------------------------------------------------------------------------------------------------------------------------------------------------------------

1:N Communications

Command

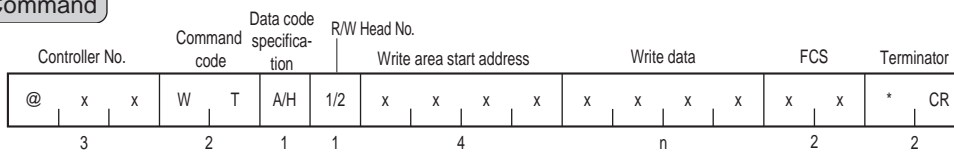

Data code specification	Specifies the type of code in which the write data is being sent. A: ASCII H: Hexadecimal
R/W Head No.	Specifies the Read/Write Head with which to communicate. 1: Read/Write Head 1 2: Read/Write Head 2
Write area start address	Specifies the first address to which to write data to the Data Carrier as a four-digit hexadecimal number. Specifiable range: 0000H to FFFFH
Write data	The data to write to Data Carrier memory. Up to 256 bytes can be written with one command. <ul style="list-style-type: none"> • ASCII specification: 256 bytes (256 characters) • Hexadecimal code specification: 256 bytes (512 characters) Note: When using hexadecimal code, set two characters for each byte.

Response

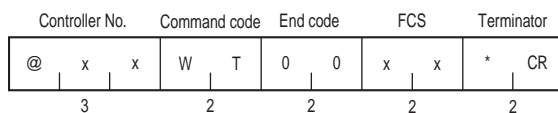

End code	Indicates the results of command execution. An end code of 00 is returned for a normal end. Refer to <i>End Codes</i> for more information.  p.133
----------	------------------------------------------------------------------------------------------------------------------------------------------------------------------------------------------------------------------------------------------

EXPANSION READ (XR)

For EXPANSION READ, the ID Controller reads up to 2 KB of Data Carrier memory data by dividing the data into frames. If there is no Data Carrier in the communications area, an error response with an error code of 72 (Data Carrier missing) will be returned.

The host device cannot send commands to the ID Controller until all response frames have been returned.

1:1 Communications

Command

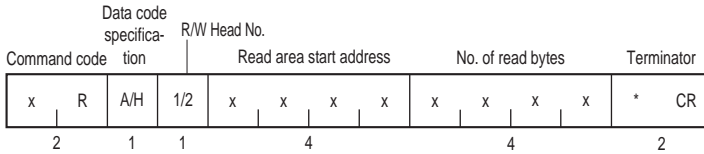

Data code specification	Specifies the type of code in which to send the read data in the response. A: ASCII H: Hexadecimal
R/W Head No.	Specifies the Read/Write Head with which to communicate. 1: Read/Write Head 1 2: Read/Write Head 2
Read area start address	Specifies the first address from which to read data from the Data Carrier as a four-digit hexadecimal number. Specifiable range: 0000H to FFFFH
No. of read bytes	Specifies the number of bytes of data to read from the Data Carrier as a four-digit hexadecimal number. Up to 2048 bytes can be read with one command. Specifiable range: 0001H to 0800H • ASCII specification: 2048 bytes (2048 characters) • Hexadecimal code specification: 2048 bytes (4096 characters)

Response

<Less Than 251 Characters in Read Data>

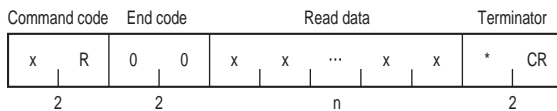

End code	Indicates the results of command execution. An end code of 00 is returned for a normal end. Refer to <i>End Codes</i> for more information.  p.133
Read data	The data read from Data Carrier memory. The number of characters will be the same as the number of read bytes for ASCII data and twice the number of read bytes for hexadecimal data.

<More Than 250 Characters in Read Data>

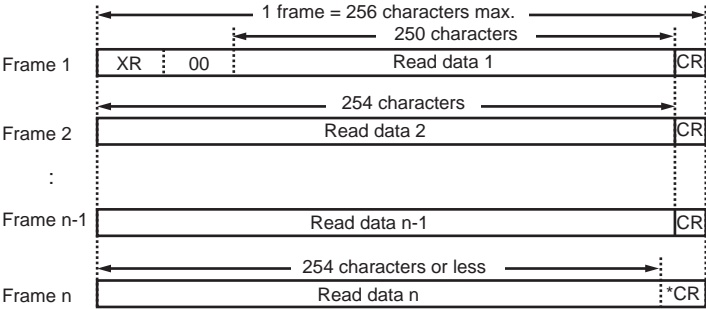

Communications Procedure

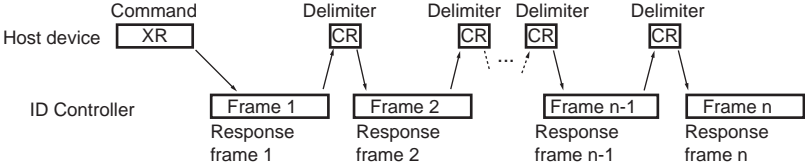

1:N Communications

Command

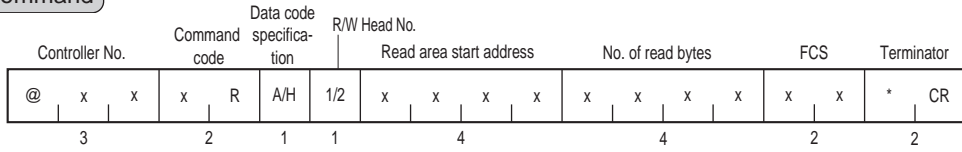

Data code specification	Specifies the type of code in which to send the read data in the response. A: ASCII H: Hexadecimal
R/W Head No.	Specifies the Read/Write Head with which to communicate. 1: Read/Write Head 1 2: Read/Write Head 2
Read area start address	Specifies the first address from which to read data from the Data Carrier as a four-digit hexadecimal number. Specifiable range: 0000H to FFFFH
No. of read bytes	Specifies the number of bytes of data to read from the Data Carrier as a four-digit hexadecimal number. Up to 2048 bytes can be read with one command. Specifiable range: 0001H to 0800H • ASCII specification: 2048 bytes (2048 characters) • Hexadecimal code specification: 2048 bytes (4096 characters)

Response

<Less than 251 Characters in Read Data>

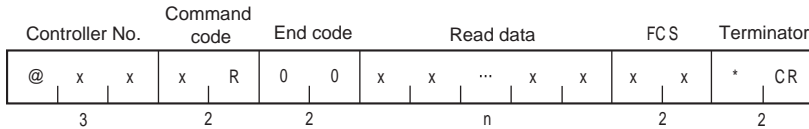

End code	Indicates the results of command execution. An end code of 00 is returned for a normal end. Refer to <i>End Codes</i> for more information.  p.133
Read data	The data read from Data Carrier memory. The number of characters will be the same as the number of read bytes for ASCII data and twice the number of read bytes for hexadecimal data.

<More Than 250 Characters in Read Data>

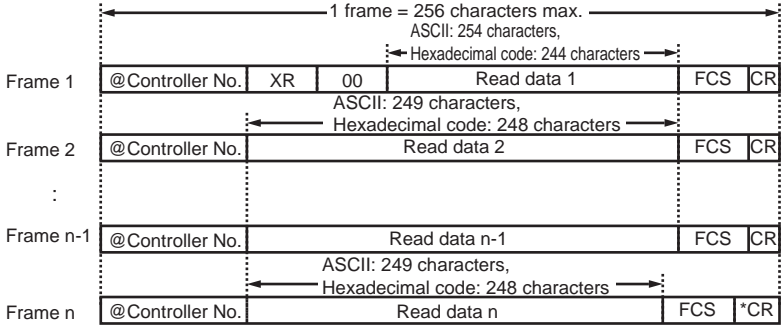

Communications Procedure

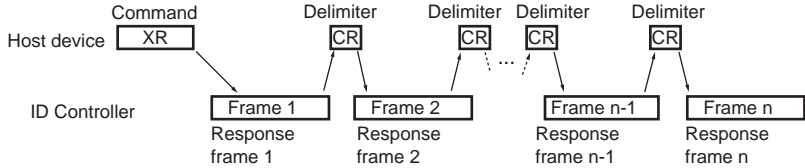

EXPANSION WRITE (XW)

For EXPANSION WRITE, the ID Controller writes up to 2 KB to Data Carrier memory data by dividing the data into frames. If there is no Data Carrier in the communications area, an error response with an error code of 72 (Data Carrier missing) will be returned.

The host device cannot send commands to the ID Controller until the response has been returned.

1:1 Communications

Command

<Frame 1>

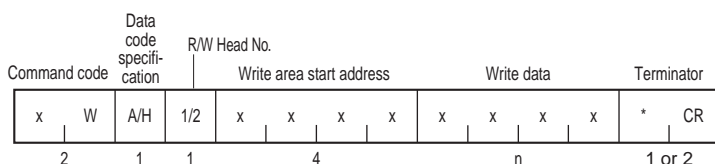

Data code specification	Specifies the type of code in which the write data is being sent. A: ASCII H: Hexadecimal
R/W Head No.	Specifies the Read/Write Head with which to communicate. 1: Read/Write Head 1 2: Read/Write Head 2
Write area start address	Specifies the first address to which to write data to the Data Carrier as a four-digit hexadecimal number. Specifiable range: 0000H to FFFFH
Write data	The data to write to Data Carrier memory. Between 1 and 257 characters can be written.
Terminator	The terminator indicates the end of the frames. CR: More frames to come. *CR: No more frames.

<Frame 2 and Later Frames>

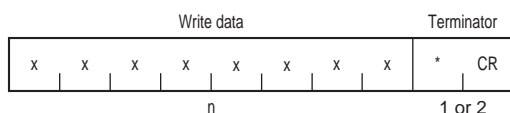

Write data	The data to write to Data Carrier memory. Between 0 and 265 characters can be written.
Terminator	The terminator indicates the end of the frames. CR: More frames to come. *CR: No more frames.

Response

Command code	End code	Terminator
x W	0 0	* CR
2	2	2

End code	Indicates the results of command execution. An end code of 00 is returned for a normal end. Refer to <i>End Codes</i> for more information.  p.133
----------	----------------------------------------------------------------------------------------------------------------------------------------------------------------------------------------------------------------------------------------

■ Frame Division

Divided the command into frames as shown below if the command is longer than 271 characters.

Frame Division

1. Divide the command so that each frame is 271 characters or less.
2. Attach a terminator (*CR) to the last frame (frame n). Attach a delimiter (CR) to all other frames.
3. The first frame (frame 1) must contain the command code, data code specification, Read/Write Head and channel specifications, and the start address. If any of these are missing, a command input error will occur. The write data does not have to be contained in the first frame.
4. Divide the command so that no frame contains "AA*CR" or "XZ*CR".

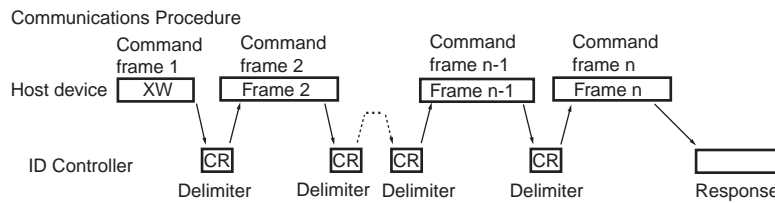
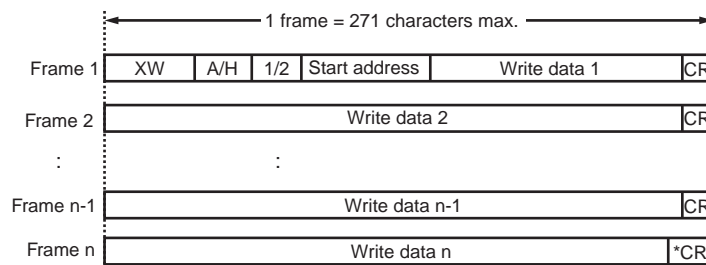

1:N Communications

Command

<Frame 1>

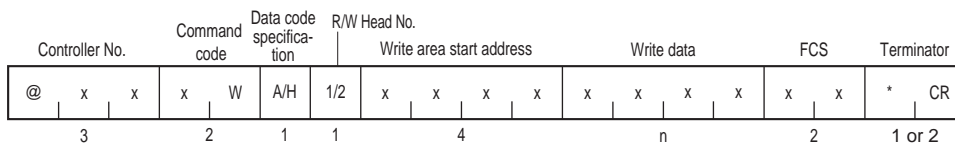

Data code specification	Specifies the type of code in which the write data is being sent. A: ASCII H: Hexadecimal
R/W Head No.	Specifies the Read/Write Head with which to communicate. 1: Read/Write Head 1 2: Read/Write Head 2
Write area start address	Specifies the first address to which to write data to the Data Carrier as a four-digit hexadecimal number. Specifiable range: 0000H to FFFFH
Write data	The data to write to Data Carrier memory. Between 1 and 257 characters can be written.
Terminator	The terminator indicates the end of the frames. CR: More frames to come. *CR: No more frames.

<Frame 2 and Later Frames>

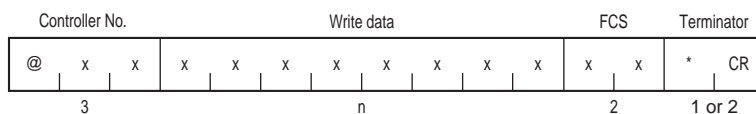

Write data	The data to write to Data Carrier memory. Between 0 and 265 characters can be written.
Terminator	The terminator indicates the end of the frames. CR: More frames to come. *CR: No more frames.

Response

Controller No.	Command code	End code	FCS	Terminator
@ x x	x W	0 0	x x	* CR
3	2	2	2	2

End code	Indicates the results of command execution. An end code of 00 is returned for a normal end. Refer to <i>End Codes</i> for more information.  p.133
----------	----------------------------------------------------------------------------------------------------------------------------------------------------------------------------------------------------------------------------------------

■ Frame Dividing Method

Divided the command into frames as shown below if the command is longer than 271 characters.

1. Divide the command so that each frame is 271 characters or less.
2. Attach a terminator (*CR) to the last frame (frame n). Attach a delimiter (CR) to all other frames.
3. The first frame (frame 1) must contain the command code, data code specification, Read/Write Head and channel specifications, and the start address. If any of these are missing, a command input error will occur. The write data does not have to be contained in the first frame.
4. Divide the command so that no frame contains "AA*CR" or "XZ*CR".
5. The controller number and FCS must be included in all frames.

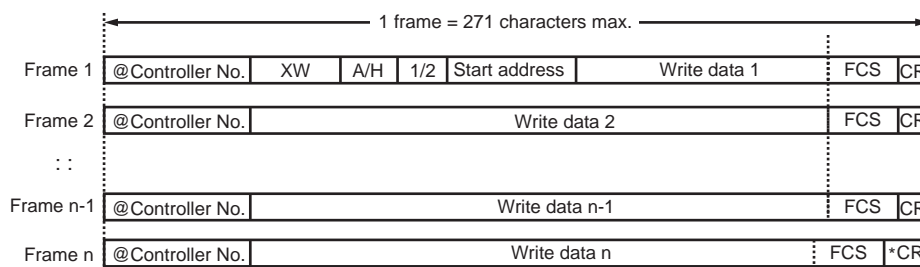

Communications Procedure

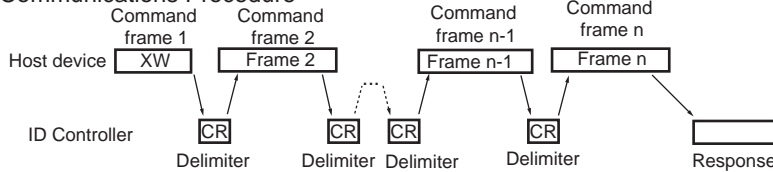

EXPANDED READ (ER)

For EXPANDED READ, the ID Controller reads up to 8 KB of data from Data Carrier memory. If there is no Data Carrier in the communications area, an error response with an error code of 72 (Data Carrier missing) will be returned.

1:1 Communications

Command

Command code		Data code specification		R/W Head No.	Read area start address				No. of read bytes				Terminator	
E	R	A/H	1/2	x	x	x	x	x	x	x	x	x	*	CR
2		1		1	4				4				2	

Data code specification	Specifies the type of code in which to send the read data in the response. A: ASCII H: Hexadecimal
R/W Head No.	Specifies the Read/Write Head with which to communicate. 1: Read/Write Head 1 2: Read/Write Head 2
Read area start address	Specifies the first address from which to read data from the Data Carrier as a four-digit hexadecimal number. Specifiable range: 0000H to FFFFH
No. of read bytes	Specifies the number of bytes of data to read from the Data Carrier as a four-digit hexadecimal number. Up to 8192 bytes can be read with one command. Specifiable range: 0001H to 2000H • ASCII specification: 8192 bytes (8192 characters) • Hexadecimal code specification: 8192 bytes (16384 characters)

Response

<Less than 242 Characters in Read Data>

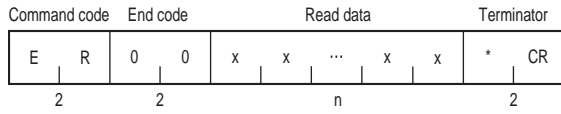

<More Than 240 Characters in Read Data>

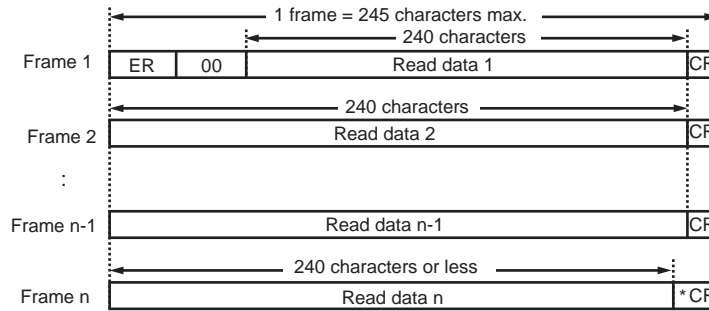

Communications Procedure

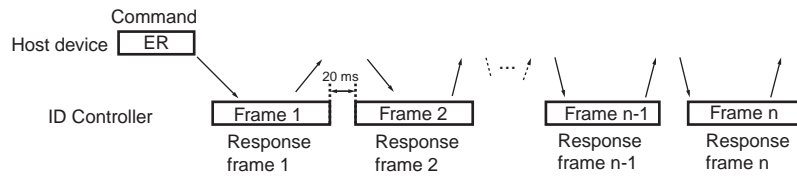

End code	Indicates the results of command execution. An end code of 00 is returned for a normal end. Refer to <i>End Codes</i> for more information. p.133
Read data	The data read from Data Carrier memory. The number of characters will be the same as the number of read bytes for ASCII data and twice the number of read bytes for hexadecimal data.

1:N Communications

Command

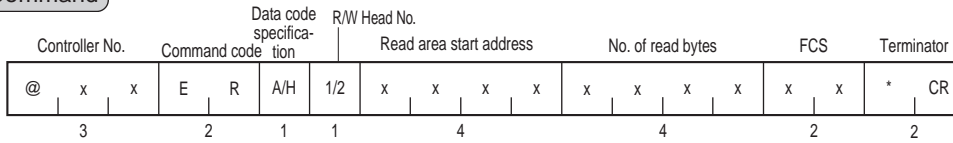

Data code specification	Specifies the type of code in which to send the read data in the response. A: ASCII H: Hexadecimal
R/W Head No.	Specifies the Read/Write Head with which to communicate. 1: Read/Write Head 1 2: Read/Write Head 2
Read area start address	Specifies the first address from which to read data from the Data Carrier as a four-digit hexadecimal number. Specifiable range: 0000H to FFFFH
No. of read bytes	Specifies the number of bytes of data to read from the Data Carrier as a four-digit hexadecimal number. Up to 8192 bytes can be read with one command. Specifiable range: 0001H to 2000H • ASCII specification: 8192 bytes (8192 characters) • Hexadecimal code specification: 8192 bytes (16384 characters)

Response

<Less than 242 Characters in Read Data>

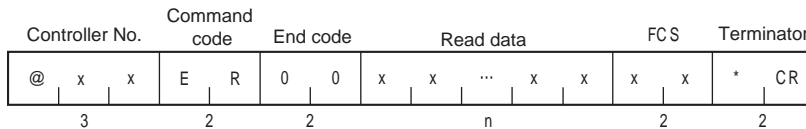

<More Than 240 Characters in Read Data>

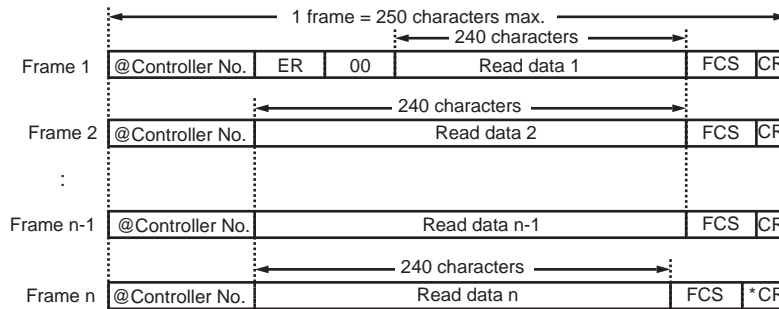

Communications Procedure

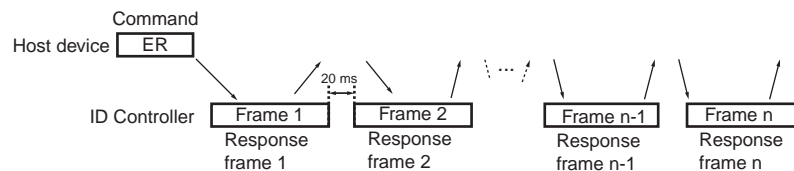

End code	Indicates the results of command execution. An end code of 00 is returned for a normal end. Refer to <i>End Codes</i> for more information. p.133
Read data	The data read from Data Carrier memory. The number of characters will be the same as the number of read bytes for ASCII data and twice the number of read bytes for hexadecimal data.

AUTO READ (AR)

For AUTO READ, the ID Controller waits for a Data Carrier to approach and then reads data from Data Carrier memory. The ID Controller will return a response to the host device when communications with the Data Carrier have been completed.

1:1 Communications

Command

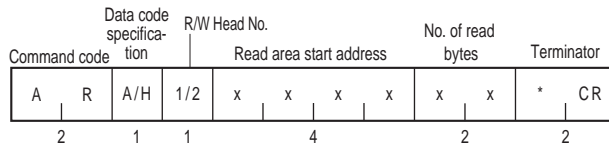

Data code specification	Specifies the type of code in which to send the read data in the response. A: ASCII H: Hexadecimal
R/W Head No.	Specifies the Read/Write Head with which to communicate. 1: Read/Write Head 1 2: Read/Write Head 2
Read area start address	Specifies the first address from which to read data from the Data Carrier as a four-digit hexadecimal number. Specifiable range: 0000H to FFFFH
No. of read bytes	Specifies the number of bytes of data to read from the Data Carrier as a two-digit hexadecimal number. Up to 256 bytes can be read with one command. Specifiable range: 00H to FFH (The maximum of 256 bytes will be read if 00H is specified.) • ASCII specification: 256 bytes (256 characters) • Hexadecimal code specification: 256 bytes (512 characters)

Response

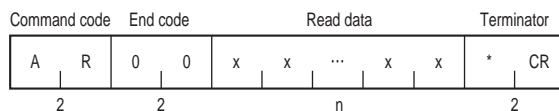

End code	Indicates the results of command execution. An end code of 00 is returned for a normal end. Refer to <i>End Codes</i> for more information.  p.133
Read data	The data read from Data Carrier memory. The number of characters will be the same as the number of read bytes for ASCII data and twice the number of read bytes for hexadecimal data.

1:N Communications

Command

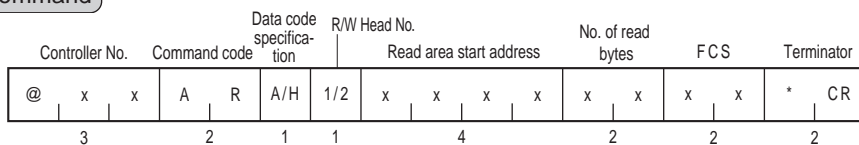

Data code specification	Specifies the type of code in which to send the read data in the response. A: ASCII H: Hexadecimal
R/W Head No.	Specifies the Read/Write Head with which to communicate. 1: Read/Write Head 1 2: Read/Write Head 2
Read area start address	Specifies the first address from which to read data from the Data Carrier as a four-digit hexadecimal number. Specifiable range: 0000H to FFFFH
No. of read bytes	Specifies the number of bytes of data to read from the Data Carrier as a two-digit hexadecimal number. Up to 256 bytes can be read with one command. Specifiable range: 00H to FFH (The maximum of 256 bytes will be read if 00H is specified.) • ASCII specification: 256 bytes (256 characters) • Hexadecimal code specification: 256 bytes (512 characters)

Response

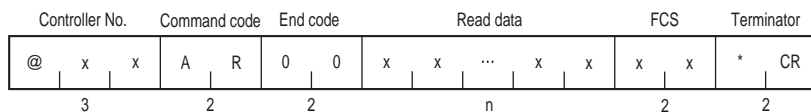

End code	Indicates the results of command execution. An end code of 00 is returned for a normal end. Refer to <i>End Codes</i> for more information.  p.133
Read data	The data read from Data Carrier memory. The number of characters will be the same as the number of read bytes for ASCII data and twice the number of read bytes for hexadecimal data.

AUTO WRITE (AW)

For AUTO WRITE, the ID Controller waits for a Data Carrier to approach and then writes data to Data Carrier memory. The ID Controller will return a response to the host device when communications with the Data Carrier have been completed.

1:1 Communications

Command

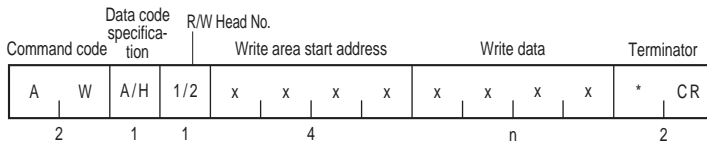

Data code specification	Specifies the type of code in which the write data is being sent. A: ASCII H: Hexadecimal
R/W Head No.	Specifies the Read/Write Head with which to communicate. 1: Read/Write Head 1 2: Read/Write Head 2
Write area start address	Specifies the first address to which to write data to the Data Carrier as a four-digit hexadecimal number. Specifiable range: 0000H to FFFFH
Write data	The data to write to Data Carrier memory. Up to 256 bytes can be written with one command. <ul style="list-style-type: none"> • ASCII specification: 256 bytes (256 characters) • Hexadecimal code specification: 256 bytes (512 characters) Note: When using hexadecimal code, set two characters for each byte.

Response

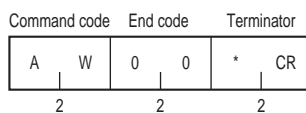

End code	Indicates the results of command execution. An end code of 00 is returned for a normal end. Refer to <i>End Codes</i> for more information.  p.133
----------	---------------------------------------------------------------------------------------------------------------------------------------------------------------------------------------------------------------------------------------------

1:N Communications

Command

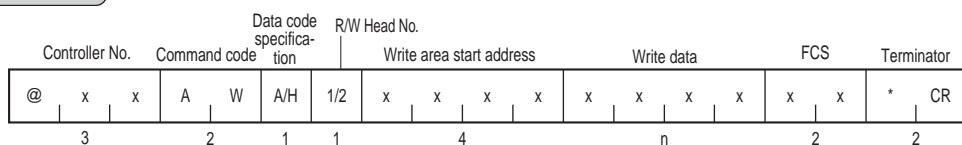

Data code specification	Specifies the type of code in which the write data is being sent. A: ASCII H: Hexadecimal
R/W Head No.	Specifies the Read/Write Head with which to communicate. 1: Read/Write Head 1 2: Read/Write Head 2
Write area start address	Specifies the first address to which to write data to the Data Carrier as a four-digit hexadecimal number. Specifiable range: 0000H to FFFFH
Write data	The data to write to Data Carrier memory. Up to 256 bytes can be written with one command. • ASCII specification: 256 bytes (256 characters) • Hexadecimal code specification: 256 bytes (512 characters) Note: When using hexadecimal code, set two characters for each byte.

Response

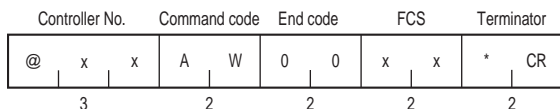

End code	Indicates the results of command execution. An end code of 00 is returned for a normal end. Refer to <i>End Codes</i> for more information.  p.133
----------	---------------------------------------------------------------------------------------------------------------------------------------------------------------------------------------------------------------------------------------------

DATA FILL (DF)

For DATA FILE, the ID Controller waits for a Data Carrier to approach and then fills Data Carrier memory with the specified number of write bytes from the start write address specified in the command. If there is no Data Carrier in the communications area, an error response with an error code of 72 (Data Carrier missing) will be returned.



CHECK!

Data will also be written to write-protected areas of the Data Carrier. Be sure that there is no important data in the write area before executing this command.

1:1 Communications

Command

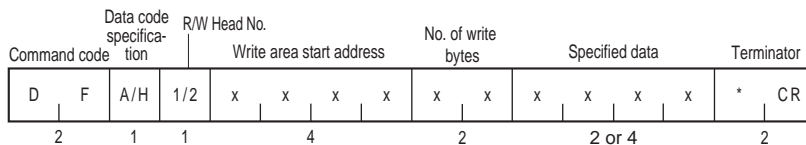

Data code specification	Specifies the type of code in which to send the read data in the response. A: ASCII H: Hexadecimal
R/W Head No.	Specifies the Read/Write Head with which to communicate. 1: Read/Write Head 1 2: Read/Write Head 2
Write area start address	Specifies the first address to which to write data to the Data Carrier as a four-digit hexadecimal number. Specifiable range: 0000H to FFFFH
No. of write bytes	Specifies the number of bytes of data to write to the Data Carrier as a two-digit hexadecimal number. Specifiable range: 01H to FFH (The maximum of 256 bytes will be written if 00H is specified.)
Specified data	The data to write to Data Carrier memory. • ASCII specification: Specify 2 bytes. • Hexadecimal code specification: Specify 4 bytes.

Response

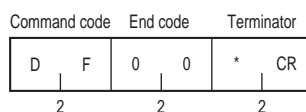

End code	Indicates the results of command execution. An end code of 00 is returned for a normal end. Refer to <i>End Codes</i> for more information. p.133
----------	---------------------------------------------------------------------------------------------------------------------------------------------------------

Example

The following example fills 6 bytes (0006H) of memory starting from address 0030H with 0101H for a Data Carrier in which the same data as the address is written.

Command

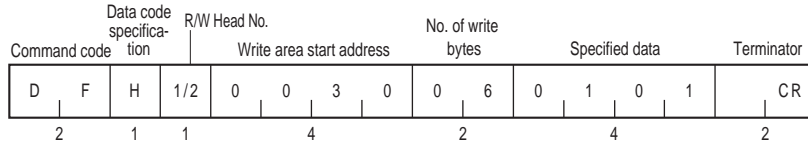

Response

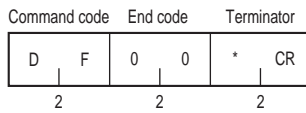

Before Writing

002FH	2	F
0030H	3	0
0031H	3	1
0032H	3	2
0033H	3	3
0034H	3	4
0035H	3	5
0036H	3	6

After Writing

002FH	2	F
0030H	0	1
0031H	0	1
0032H	0	1
0033H	0	1
0034H	0	1
0035H	0	1
0036H	3	6

1:N Communications

Command

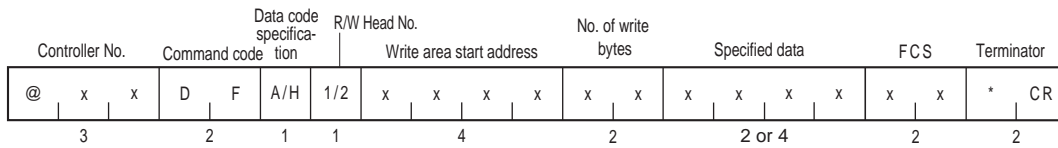

Data code specification	Specifies the type of code in which to send the read data in the response. A: ASCII H: Hexadecimal
R/W Head No.	Specifies the Read/Write Head with which to communicate. 1: Read/Write Head 1 2: Read/Write Head 2
Write area start address	Specifies the first address to which to write data to the Data Carrier as a four-digit hexadecimal number. Specifiable range: 0000H to FFFFH
No. of write bytes	Specifies the data to write to the Data Carrier as a four-digit hexadecimal number. Specifiable range: 01H to FFH (The maximum of 256 bytes will be written if 00H is specified.)
Specified data	The data to write to Data Carrier memory. • ASCII specification: Specify 2 bytes. • Hexadecimal code specification: Specify 4 bytes.

Response

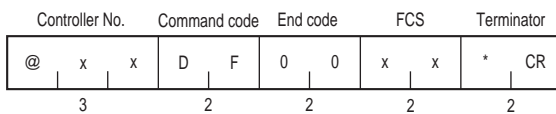

End code	Indicates the results of command execution. An end code of 00 is returned for a normal end. Refer to <i>End Codes</i> for more information.  p.133
----------	---------------------------------------------------------------------------------------------------------------------------------------------------------------------------------------------------------------------------------------------

AUTO DATA FILL (AF)

For AUTO DATA FILL, the ID Controller waits for a Data Carrier to approach and then fills Data Carrier memory with the specified number of write bytes from the start write address specified in the command.

The ID Controller will return a response to the host device when communications with the Data Carrier have been completed.



Data will also be written to write-protected areas of the Data Carrier. Be sure that there is no important data in the write area before executing this command.

1:1 Communications

Command

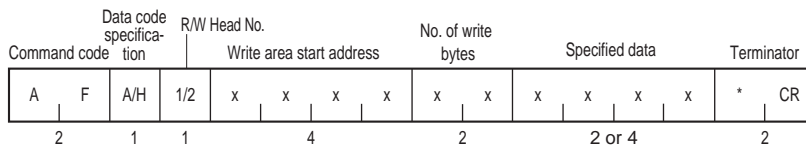

Data code specification	Specifies the type of code in which to send the read data in the response. A: ASCII H: Hexadecimal
R/W Head No.	Specifies the Read/Write Head with which to communicate. 1: Read/Write Head 1 2: Read/Write Head 2
Write area start address	Specifies the first address to which to write data to the Data Carrier as a four-digit hexadecimal number. Specifiable range: 0000H to FFFFH
No. of write bytes	Specifies the number of bytes of data to write to the Data Carrier as a two-digit hexadecimal number. Specifiable range: 01H to FFH (The maximum of 256 bytes will be written if 00H is specified.)
Specified data	The data to write to Data Carrier memory. • ASCII specification: Specify 2 bytes. • Hexadecimal code specification: Specify 4 bytes.

Response

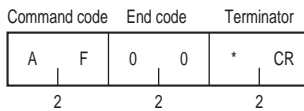

End code	Indicates the results of command execution. An end code of 00 is returned for a normal end. Refer to <i>End Codes</i> for more information. p.133
----------	------------------------------------------------------------------------------------------------------------------------------------------------------

■ 1:N Communications

Command

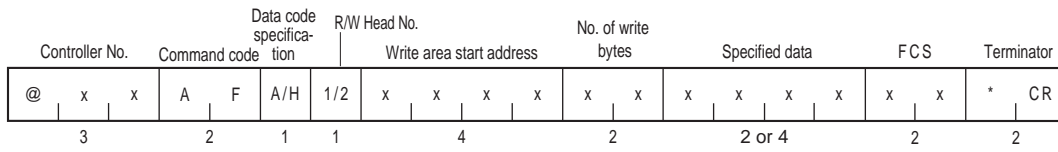

Data code specification	Specifies the type of code in which to send the read data in the response. A: ASCII H: Hexadecimal
R/W Head No.	Specifies the Read/Write Head with which to communicate. 1: Read/Write Head 1 2: Read/Write Head 2
Write area start address	Specifies the first address to which to write data to the Data Carrier as a four-digit hexadecimal number. Specifiable range: 0000H to FFFFH
No. of write bytes	Specifies the data to write to the Data Carrier as a two-digit hexadecimal number. Specifiable range: 01H to FFH (The maximum of 256 bytes will be written if 00H is specified.)
Specified data	The data to write to Data Carrier memory. • ASCII specification: Specify 2 bytes. • Hexadecimal code specification: Specify 4 bytes.

Response

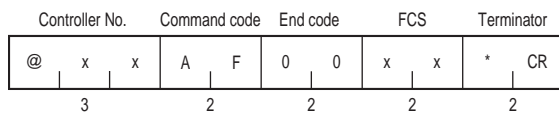

End code	Indicates the results of command execution. An end code of 00 is returned for a normal end. Refer to <i>End Codes</i> for more information.  p.133
----------	---------------------------------------------------------------------------------------------------------------------------------------------------------------------------------------------------------------------------------------------

COPY (CP)

For COPY, the ID Controller writes data read from Data Carrier memory by one Read/Write Head to the memory of a Data Carrier in the communications area of the other Read/Write Head. If the source Data Carrier is missing, the ID Controller will return a response with an error code of 72 (Data Carrier missing). If the destination Data Carrier is missing, the ID Controller will return a response with an error code of 76 (copy error).

1:1 Communications

Command

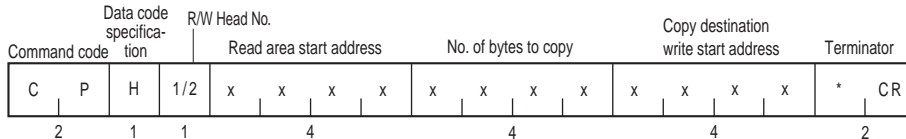

Data code specification	Always "H" (hexadecimal code).
R/W Head No.	Specifies the Read/Write Head with which to communicate. 1: Read from Read/Write Head 1 and write to Read/Write Head 2. 2: Read from Read/Write Head 2 and write to Read/Write Head 1.
Read area start address	Specifies the first address from which to read data from the Data Carrier as a four-digit hexadecimal number. Specifiable range: 0000H to FFFFH
No. of bytes to copy	Specifies the number of bytes of data to copy as a four-digit hexadecimal number. Specifiable range: 0001H to 0800H
Copy destination write start address	Specifies the first address to which to write data to the Data Carrier as a four-digit hexadecimal number. Specifiable range: 0000H to FFFFH

Response

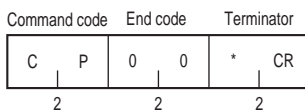

End code	Indicates the results of command execution. An end code of 00 is returned for a normal end. Refer to <i>End Codes</i> for more information.  p.133
----------	---------------------------------------------------------------------------------------------------------------------------------------------------------------------------------------------------------------------------------------------

1:N Communications

Command

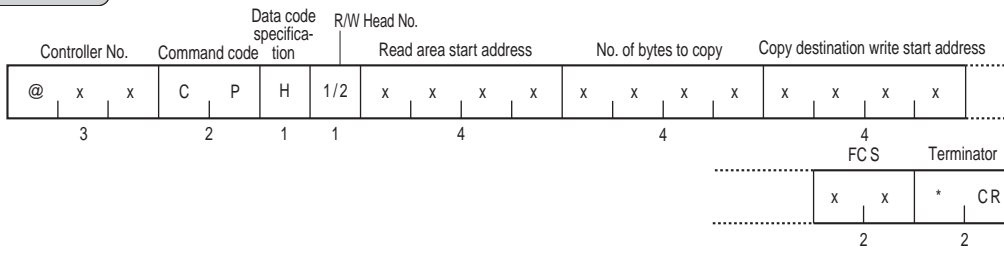

Data code specification	Always "H" (hexadecimal code).
R/W Head No.	Specifies the Read/Write Head with which to communicate. 1: Read from Read/Write Head 1 and write to Read/Write Head 2. 2: Read from Read/Write Head 2 and write to Read/Write Head 1.
Read area start address	Specifies the first address from which to read data from the Data Carrier as a four-digit hexadecimal number. Specifiable range: 0000H to FFFFH
No. of bytes to copy	Specifies the number of bytes of data to copy as a four-digit hexadecimal number. Specifiable range: 0001H to 0800H
Copy destination write start address	Specifies the first address to which to write data to the Data Carrier as a four-digit hexadecimal number. Specifiable range: 0000H to FFFFH

Response

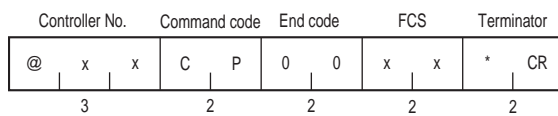

End code	Indicates the results of command execution. An end code of 00 is returned for a normal end. Refer to <i>End Codes</i> for more information.  p.133
----------	---------------------------------------------------------------------------------------------------------------------------------------------------------------------------------------------------------------------------------------------

AUTO COPY (AP)

For AUTO COPY, the ID Controller waits until a Data Carrier approaches and then Writes data read from Data Carrier memory by one Read/Write Head to the memory of a Data Carrier in the communications area of the other Read/Write Head.

The data is always written to the destination Data Carrier on the trigger.

1:1 Communications

Command

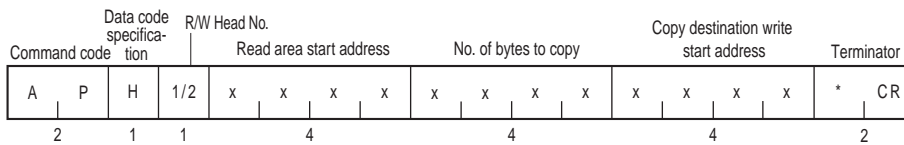

Data code specification	Always "H" (hexadecimal code).
R/W Head No.	Specifies the Read/Write Head with which to communicate. 1: Read from Read/Write Head 1 and write to Read/Write Head 2. 2: Read from Read/Write Head 2 and write to Read/Write Head 1.
Read area start address	Specifies the first address from which to read data from the Data Carrier as a four-digit hexadecimal number. Specifiable range: 0000H to FFFFH
No. of bytes to copy	Specifies the number of bytes of data to copy as a four-digit hexadecimal number. Specifiable range: 0001H to 0800H
Copy destination write start address	Specifies the first address to which to write data to the Data Carrier as a four-digit hexadecimal number. Specifiable range: 0000H to FFFFH

Response

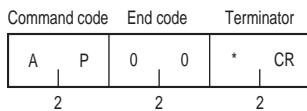

End code	Indicates the results of command execution. An end code of 00 is returned for a normal end. Refer to <i>End Codes</i> for more information.  p.133
----------	---------------------------------------------------------------------------------------------------------------------------------------------------------------------------------------------------------------------------------------------

■ 1:N Communications

Command

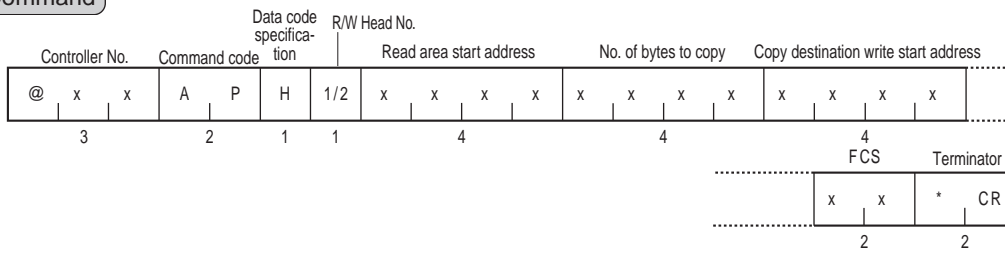

Data code specification	Always "H" (hexadecimal code).
R/W Head No.	Specifies the Read/Write Head with which to communicate. 1: Read from Read/Write Head 1 and write to Read/Write Head 2. 2: Read from Read/Write Head 2 and write to Read/Write Head 1.
Read area start address	Specifies the first address from which to read data from the Data Carrier as a four-digit hexadecimal number. Specifiable range: 0000H to FFFFH
No. of bytes to copy	Specifies the number of bytes of data to copy as a four-digit hexadecimal number. Specifiable range: 0001H to 0800H
Copy destination write start address	Specifies the first address to which to write data to the Data Carrier as a four-digit hexadecimal number. Specifiable range: 0000H to FFFFH

Response

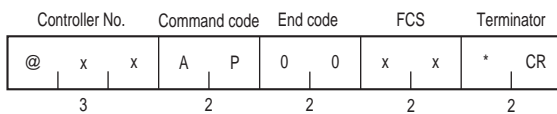

End code	Indicates the results of command execution. An end code of 00 is returned for a normal end. Refer to <i>End Codes</i> for more information.  p.133
----------	---------------------------------------------------------------------------------------------------------------------------------------------------------------------------------------------------------------------------------------------

POLLING AUTO READ (PR)

For POLLING AUTO READ, the ID Controller immediately returns a response informing the host device that the command has been received. The ID Controller then waits for a Data Carrier to approach and reads data from Data Carrier memory. During this time, the host device can check the results of command processing by using a subcommand. Also, the host device can send commands to the other Read/Write Head.

1:1 Communications

Command

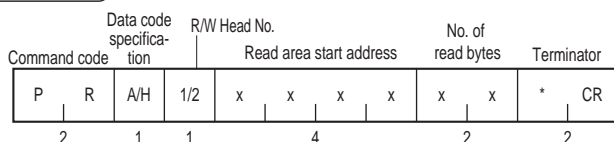

Data code specification	Specifies the type of code in which to send the read data in the response. A: ASCII H: Hexadecimal
R/W Head No.	Specifies the Read/Write Head with which to communicate. 1: Read/Write Head 1 2: Read/Write Head 2
Read area start address	Specifies the first address from which to read data from the Data Carrier as a four-digit hexadecimal number. Specifiable range: 0000H to FFFFH
No. of read bytes	Specifies the number of bytes of data to read from the Data Carrier as a two-digit hexadecimal number. Up to 256 bytes can be read with one command. Specifiable range: 00H to FFH (The maximum of 256 bytes will be read if 00H is specified.) • ASCII specification: 256 bytes (256 characters) • Hexadecimal code specification: 256 bytes (512 characters)

Response

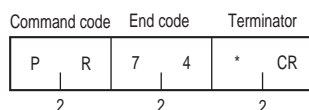

End code	Indicates the results of command execution. 74: Polling command received. The only error codes returned here are 74 and error codes for communications errors with the host. Refer to <i>End Codes</i> for more information.  p.133
----------	------------------------------------------------------------------------------------------------------------------------------------------------------------------------------------------------------------------------------------------------------------------------------------------------------------------------------------

Subcommands

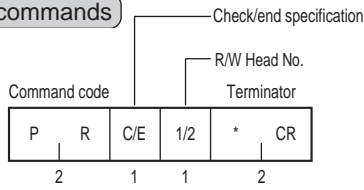

Check/end specification	Specifies checking processing results or ending (terminating) the command. C: Check processing E: End
R/W Head No.	Specifies the Read/Write Head with which to communicate. 1: Read/Write Head 1 2: Read/Write Head 2

Subcommand Responses

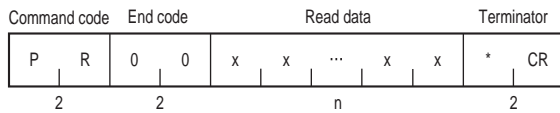

End code	Indicates the results of command execution. 00: Normal end 74: A Data Carrier has not approached when the command to check results was executed. 75: A Data Carrier has not approached when polling auto processing was ended. 76: Communications with the Data Carrier were in process or processing was finished when polling auto processing was ended. Refer to <i>End Codes</i> for more information. p.133
Read data	Indicates the read data for the executed command.

1:N Communications

Command

Controller No.			Command code		Data code specification		R/W Head No.		Read area start address				No. of read bytes		FCS		Terminator	
@	x	x	P	R	A/H	1/2	x	x	x	x	x	x	x	x	x	x	*	CR
3			2		1 1		4				2		2		2			

Data code specification	Specifies the type of code in which to send the read data in the response. A: ASCII H: Hexadecimal
R/W Head No.	Specifies the Read/Write Head with which to communicate. 1: Read/Write Head 1 2: Read/Write Head 2
Read area start address	Specifies the first address from which to read data from the Data Carrier as a four-digit hexadecimal number. Specifiable range: 0000H to FFFFH
No. of read bytes	Specifies the number of bytes of data to read from the Data Carrier as a two-digit hexadecimal number. Up to 256 bytes can be read with one command. Specifiable range: 00H to FFH (The maximum of 256 bytes will be read if 00H is specified.) • ASCII specification: 256 bytes (256 characters) • Hexadecimal code specification: 256 bytes (512 characters)

Response

Controller No.			Command code		End code		FCS		Terminator	
@	x	x	P	R	7	4	x	x	*	CR
3			2		2		2		2	

End code	Indicates the results of command execution. 74: Polling command received. The only error codes returned here are 74 and error codes for communications errors with the host device. Refer to <i>End Codes</i> for more information.  p.133
----------	-------------------------------------------------------------------------------------------------------------------------------------------------------------------------------------------------------------------------------------------------------------------------------------------------------------------------------------------

Subcommands

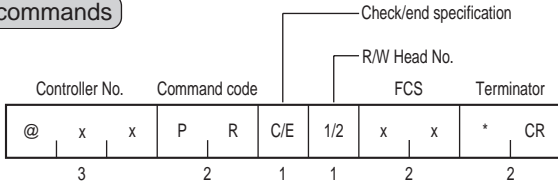

Check/End specification	Specifies checking processing results or ending (terminating) the command. C: Check processing E: End
R/W Head No.	Specifies the Read/Write Head with which to communicate. 1: Read/Write Head 1 2: Read/Write Head 2

Subcommand Responses

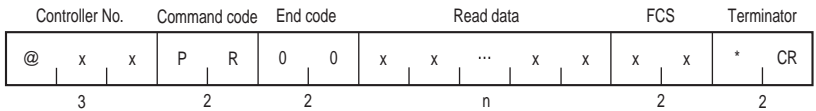

End code	Indicates the results of command execution. 00: Normal end 74: A Data Carrier has not approached when the command to check results was executed. 75: A Data Carrier has not approached when polling auto processing was ended. 76: Communications with the Data Carrier were in process or processing was finished when polling auto processing was ended. Refer to <i>End Codes</i> for more information.  p.133
Read data	Indicates the read data for the executed command.

POLLING AUTO WRITE (PW)

For POLLING AUTO WRITE, the ID Controller immediately returns a response informing the host device that the command has been received. The ID Controller then waits for a Data Carrier to approach and writes data to Data Carrier memory. During this time, the host device can check on the result of the command processing by using a subcommand.

1:1 Communications

Command

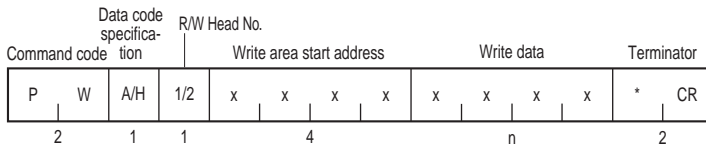

Data code specification	Specifies the type of code in which the write data is being sent. A: ASCII H: Hexadecimal
R/W Head No.	Specifies the Read/Write Head with which to communicate. 1: Read/Write Head 1 2: Read/Write Head 2
Write area start address	Specifies the first address to which to write data to the Data Carrier as a four-digit hexadecimal number. Specifiable range: 0000H to FFFFH
Write data	The data to write to Data Carrier memory. Up to 256 bytes can be written with one command. • ASCII specification: 256 bytes (256 characters) • Hexadecimal code specification: 256 bytes (512 characters) Note: When using hexadecimal code, set two characters for each byte.

Response

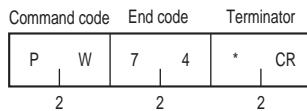

End code	Indicates the results of command execution. 74: Polling command received. The only error codes returned here are 74 and error codes for communications errors with the host device. Refer to <i>End Codes</i> for more information.  p.133
----------	-------------------------------------------------------------------------------------------------------------------------------------------------------------------------------------------------------------------------------------------------------------------------------------------------------------------------------------------

Subcommands

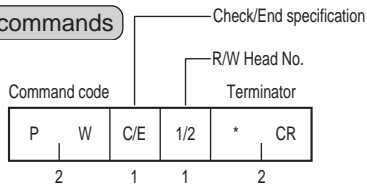

Check/End specification	Specifies checking processing results or ending (terminating) the command. C: Check processing E: End
R/W Head No.	Specifies the Read/Write Head with which to communicate. 1: Read/Write Head 1 2: Read/Write Head 2

Subcommand Responses

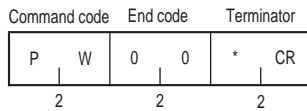

End code	Indicates the results of command execution. 00: Normal end 74: A Data Carrier has not approached when the command to check results was executed. 75: A Data Carrier has not approached when polling auto processing was ended. 76: Communications with the Data Carrier were in process or processing was finished when polling auto processing was ended. Refer to <i>End Codes</i> for more information.  p.133
----------	------------------------------------------------------------------------------------------------------------------------------------------------------------------------------------------------------------------------------------------------------------------------------------------------------------------------------------------------------------------------------------------------------------------------------------------------------------------------------------------------------------------------

1:N Communications

Command

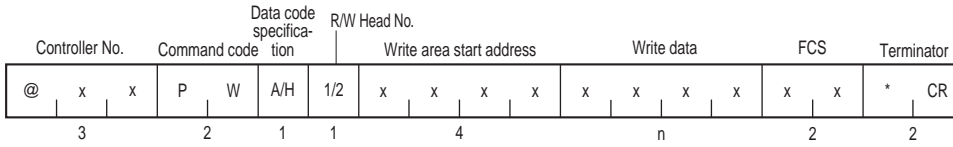

Data code specification	Specifies the type of code in which the write data is being sent. A: ASCII H: Hexadecimal
R/W Head No.	Specifies the Read/Write Head with which to communicate. 1: Read/Write Head 1 2: Read/Write Head 2
Write area start address	Specifies the first address to which to write data to the Data Carrier as a four-digit hexadecimal number. Specifiable range: 0000H to FFFFH
Write data	The data to write to Data Carrier memory. Up to 256 bytes can be written with one command. <ul style="list-style-type: none"> • ASCII specification: 256 bytes (256 characters) • Hexadecimal code specification: 256 bytes (512 characters) Note: When using hexadecimal code, set two characters for each byte.

Response

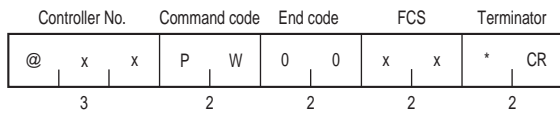

End code	Indicates the results of command execution. 74: Polling command received. The only error codes returned here are 74 and error codes for communications errors with the host device. Refer to <i>End Codes</i> for more information.  p.133
----------	-------------------------------------------------------------------------------------------------------------------------------------------------------------------------------------------------------------------------------------------------------------------------------------------------------------------------------------------

Subcommands

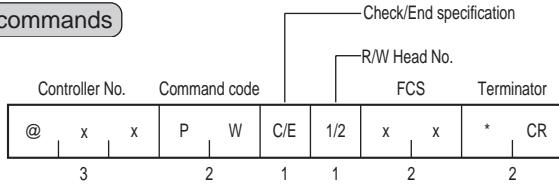

Check/End specification	Specifies checking processing results or ending (terminating) the command. C: Check processing E: End
R/W Head No.	Specifies the Read/Write Head with which to communicate. 1: Read/Write Head 1 2: Read/Write Head 2

Subcommand Responses

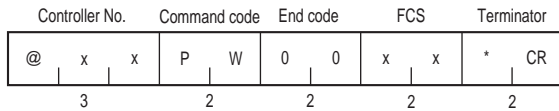

End code	Indicates the results of command execution. 00: Normal end 74: A Data Carrier has not approached when the command to check results was executed. 75: A Data Carrier has not approached when polling auto processing was ended. 76: Communications with the Data Carrier were in process or processing was finished when polling auto processing was ended. Refer to <i>End Codes</i> for more information.  p.133
----------	------------------------------------------------------------------------------------------------------------------------------------------------------------------------------------------------------------------------------------------------------------------------------------------------------------------------------------------------------------------------------------------------------------------------------------------------------------------------------------------------------------------------

MANAGEMENT DATA CHECK/CALCULATE (MDC/MDK)

These commands make it possible to write and verify the CRC code in a check block that the user designates. The CRC code is calculated using the formula $X^{16} + X^{12} + X^5 + 1$.

1:1 Communications

Command

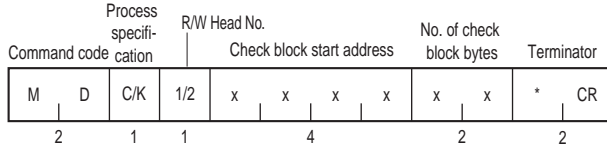

Process specification	Specifies the check processing to perform. C: Compare check code K: Calculate check code
R/W Head No.	Specifies the Read/Write Head with which to communicate. 1: Read/Write Head 1 2: Read/Write Head 2
Check block start address	Specifies the first address of the check block as a four-digit hexadecimal number. Specifiable range: 0000H to FFFDH
No. of check block bytes	Specifies the number of bytes in the check block as a two-digit hexadecimal number. Specifiable range: 00H and 03H to FFH (The maximum of 256 bytes will be read if 00H is specified.) Specify two bytes more than the number of bytes in the area for which the check code is calculated. Refer to <i>Data Carrier Memory Check Function</i> for details.  p.64

Response

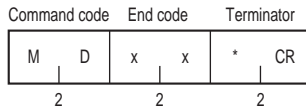

Terminator	Indicates the results of command execution. 00: Normal end 75: Data normal (only when comparing check codes) 76: Data error warning (only when comparing check codes) Refer to <i>End Codes</i> for more information.  p.133
------------	--------------------------------------------------------------------------------------------------------------------------------------------------------------------------------------------------------------------------------------------------------------------------------------------------------------------------------



Refer to *Data Carrier Memory Check Function* for details on memory checks.

 p.64

1:N Communications

Command



Controller No.			Command code		Process specification	R/W Head No.	Check block start address				No. of check block bytes		FCS		Terminator	
@	x	x	M	D	C/K	1/2	x	x	x	x	x	x	x	x	*	CR
3			2		1	1	4				2		2		2	

Process specification	Specifies the check processing to perform. C: Compare check code K: Calculate check code
R/W Head No.	Specifies the Read/Write Head with which to communicate. 1: Read/Write Head 1 2: Read/Write Head 2
Check block start address	Specifies the first address of the check block as a four-digit hexadecimal number. Specifiable range: 0000H to FFFDH
No. of check block bytes	Specifies the number of bytes in the check block as a two-digit hexadecimal number. Specifiable range: 00H and 03H to FFH (The maximum of 256 bytes will be read if 00H is specified.) Specify two bytes more than the number of bytes in the area for which the check code is calculated. Refer to <i>Data Carrier Memory Check Function</i> for details.  p.64

Response

Controller No.			Command code		End code		FCS		Terminator	
@	x	x	M	D	x	x	x	x	*	CR
3			2		2		2		2	

End code	Indicates the results of command execution. 00: Normal end 75: Data normal (only when comparing check codes) 76: Data error warning (only when comparing check codes) Refer to <i>End Codes</i> for more information.  p.133
----------	--------------------------------------------------------------------------------------------------------------------------------------------------------------------------------------------------------------------------------------------------------------------------------------------------------------------------------

 Refer to *Data Carrier Memory Check Function* for details on memory checks.
CHECK!  p.64

MANAGEMENT DATA SUBTRACTION/LIMIT (MDS/MDL)

These command are used to control the number of times that a Data Carrier without a battery can be overwritten. By updating the management area designated by the user, the user can determine whether the number of times the EEPROM has been overwritten exceeds the set number.

1:1 Communications

Command

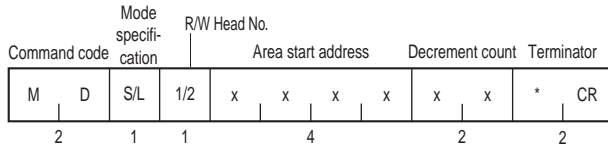

Mode specification	Specifies the check processing to perform. S: Subtraction (The number of overwrites can be set to any value up to 16,700,000 overwrites.) (See note.) L: Addition limit (The overwrite limit is always 100,000 overwrites.)
R/W Head No.	Specifies the Read/Write Head with which to communicate. 1: Read/Write Head 1 2: Read/Write Head 2
Area start address	Specifies the first address of the overwrite control area as a four-digit hexadecimal number. Specifiable range: 0000H to FFFDH
Decrement count	Specifies the number of counts to update the overwrite count as a two-digit hexadecimal number. Specifiable range: 00H to FFH (The overwrite could will only be checked if 00H is specified.) Refer to <i>Data Carrier Service Life Detection</i> for details.  p.61

Note: The write life of a Data Carrier without a battery at an ambient temperature of 40°C is 300,000 overwrites.



Set the start address to between □□□0H and □□□5H or between □□□8H and □□□DH. If the start address is set between □□□6H and □□□7H or between □□□EH and □□□FH, an address error (error code: 7A hexadecimal) will be returned as the end code.

Response

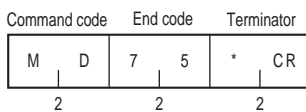

End code	Indicates the results of command execution. 75: Normal end 76: Data error warning Refer to <i>End Codes</i> for more information.  p.133
----------	-----------------------------------------------------------------------------------------------------------------------------------------------------------------------------------------------------------------------------------------

1:N Communications

Command

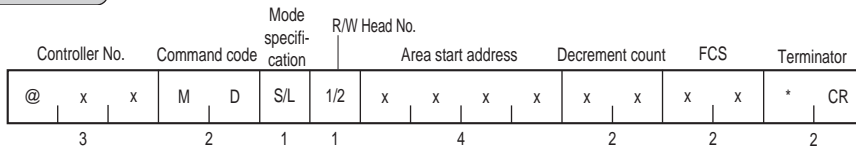

Mode specification	Specifies the check processing to perform. S: Subtraction (The number of overwrites can be set to any value up to 16,700,000 overwrites.) (See note.) L: Addition (The overwrite limit is always 100,000 overwrites.)
R/W Head No.	Specifies the Read/Write Head with which to communicate. 1: Read/Write Head 1 2: Read/Write Head 2
Area start address	Specifies the first address of the overwrite control area as a four-digit hexadecimal number. Specifiable range: 0000H to FFFDH
Decrement count	Specifies the number of counts to update the overwrite count as a two-digit hexadecimal number. Specifiable range: 00H to FFH (The overwrite could will only be checked if 00H is specified.) Refer to <i>Data Carrier Service Life Detection</i> for details.  p.61

Note: The write life of a Data Carrier without a battery at an ambient temperature of 40°C is 300,000 overwrites.



Set the start address to between □□□0H and □□□5H or between □□□8H and □□□DH. If the start address is set between □□□6H and □□□7H or between □□□EH and □□□FH, an address error (error code: 7A hexadecimal) will be returned as the end code.

Response

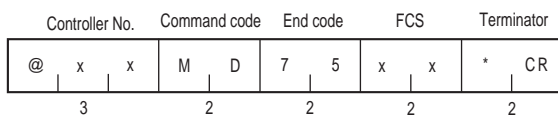

End code	Indicates the results of command execution. 75: Normal end 76: Data error warning Refer to <i>End Codes</i> for more information.  p.133
----------	-----------------------------------------------------------------------------------------------------------------------------------------------------------------------------------------------------------------------------------------

WRITE PROCESSING REPEAT (RP)

WRITE PROCESSING REPEAT executes the most recently executed Write Command.

1:1 Communications

Command

Command code		Terminator
R	P	* CR
2	2	2

Response

Command code		End code	Terminator
x	x	0 0	* CR
2	2	2	2

Command code	The command code of the most recently executed Write Command.
End code	Indicates the results of command execution. 00: Normal end Refer to <i>End Codes</i> for more information.  p.133



Write Command information is cleared under the following condition.

- If the ID Controller's power supply is reset

A command input error will occur if WRITE REPEAT is executed under this condition.

■ 1:N Communications

Command

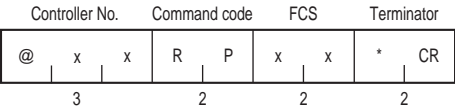

Response

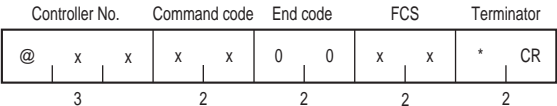

Command code	The command code of the most recently executed Write Command.
End code	Indicates the results of command execution. 00: Normal end Refer to <i>End Codes</i> for more information.  p.133



Write Command information is cleared under the following conditions.

- If the ID Controller's power supply is reset

A command input error will occur if WRITE REPEAT is executed under this condition.

General Communications Subcommands

These commands are used in combination with a Communications Command and cannot be used alone to execute communications with Data Carriers.

COMMAND PROCESSING TERMINATE (AA)

COMMAND PROCESSING TERMINATE is used to cancel command processing and return to Command Wait Status for any command except for Polling Commands. Communications divided into frames for Expansion Command can also be canceled.

1:1 Communications

Command

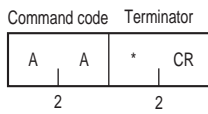

Response

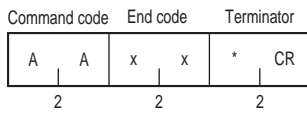

End code	Indicates the results of command execution.
	14: Auto or Normal Command processing has not been executed.
	75: Processing was canceled before a Data Carrier was detected.
	76: Processing was canceled during read/write processing with a Data Carrier.
	Refer to <i>End Codes</i> for more information.
	 p.133

■ 1:N Communications

Command

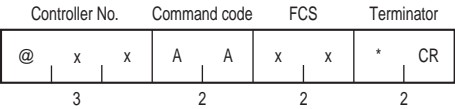

Response

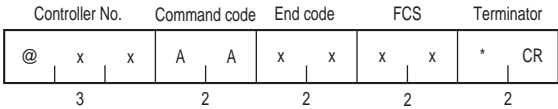

End code	<p>Indicates the results of command execution.</p> <p>14: Auto or Normal Command processing has not been executed.</p> <p>75: Processing was canceled before a Data Carrier was detected.</p> <p>76: Processing was canceled during read/write processing with a Data Carrier.</p> <p>Refer to <i>End Codes</i> for more information.</p> <p> p.133</p>
-----------------	------------------------------------------------------------------------------------------------------------------------------------------------------------------------------------------------------------------------------------------------------------------------------------------------------------------------------------------------------------------------------------------------------------------------------------------

ABORT (XZ)

If the ID Controller does not return a response due to a problem during host communications or during communications with a Data Carrier, the ABORT command can be executed to restore the ID Controller to the Command Wait Status.

No response will be returned to the ABORT command.

1:1 Communications

Command

Command code	Terminator
X Z	* CR
2	2



CHECK!

The ID Controller requires about 100 ms before it can receive the next command after it receives the ABORT command.

1:N Communications

Command

Controller No.	Command code	FCS	Terminator
@ x x	x Z	x x	* CR
3	2	2	2



CHECK!

The ID Controller requires about 100 ms before it can receive the next command after it receives the ABORT command.

Host Device Commands

TEST (TS)

For TEST, the ID Controller returns the test message sent from the host device without any changes. Use TEST to text communications between the host device and ID Controller.

1:1 Communications

Command

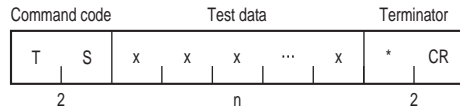

Test data	Any text string for testing communications. Up to 262 characters can be specified.
-----------	------------------------------------------------------------------------------------

Response

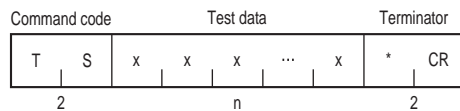

1:N Communications

Command

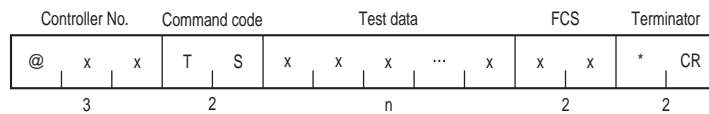

Test data	Any text string for testing communications. Up to 262 characters can be specified.
-----------	------------------------------------------------------------------------------------

Response

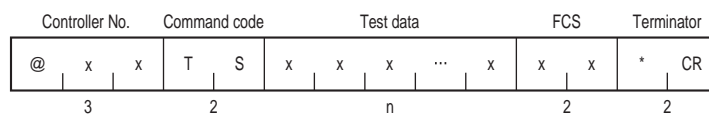

CONTROLLER CONTROL (CC)

CONTROLLER CONTROL is used to manipulate user I/O.

1:1 Communications

Command

Command code		Process code		OUT1 control	OUT2 control	Terminator	
C	C	0	0	x	x	*	CR
2		2		1	1	2	

Process code	Always "00".
OUT1/OUT2 control	0: No operation 1: Turn ON output 2: Turn OFF output

Response

Command code		End code		Input status		Output status		Terminator	
C	C	0	0	x	x	x	x	*	CR
2		2		2		2		2	

End code	Indicates the results of command execution. 00: Normal end Refer to <i>End Codes</i> for more information.  p.133
Input status	The current input status. First character: IN1 or TRG1, Second character: IN2 or TRG2 0: OFF 1: ON
Output status	The output input status after execution. First character: OUT1, Second character: OUT2 0: OFF 1: ON

1:N Communications

Command

Controller No.	Command code	Process code	OUT1 control	OUT2 control	FCS	Terminator
@	x x	C C	0 0	x x	x x	* CR
3	2	2	1	1	2	2

Process code	Always "00".
OUT1/OUT2 control	0: No operation 1: Turn ON output 2: Turn OFF output

Response

Controller No.	Command code	End code	Input status	Output status	FCS	Terminator
@	x x	C C	0 0	x x	x x	* CR
3	2	2	2	2	2	2

End code	Indicates the results of command execution. 00: Normal end Refer to <i>End Codes</i> for more information.  p.133
Input status	The current input status. First character: IN1 or TRG1, Second character: IN2 or TRG2 0: OFF 1: ON
Output status	The output input status after execution. First character: OUT1, Second character: OUT2 0: OFF 1: ON

ERROR INFORMATION READ (CF)

ERROR INFORMATION READ reads the most recent error information.

1:1 Communications

Command

Command code	Process code	Terminator
C F	x x	* CR
2	2	2

Process code	Specifies the Read/Write Head with which to communicate. 00: Read error information 01: Clear error information
--------------	-----------------------------------------------------------------------------------------------------------------------

Response

Command code	End code	Most recent error log information	Terminator
C F	0 0	R D 1 7 0) R D 1 4	* CR
2	2	n	2

End code	Indicates the results of command execution. 00: Normal end Refer to <i>End Codes</i> for more information.  p.133
Most recent error log information	The most recent 30 error records from the error log. The most recent error log information is arranged in the order of occurrence. Five characters are used for each error. <div style="margin-left: 40px;"> RD 1 70 ├── Error code ├── Error head number (for communications errors with Data Carriers only) A space will be returned for errors other than communications errors with Data Carriers. └── Error command </div>

1:N Communications

Command

Controller No.	Command code	Process code	FCS	Terminator
@ x x	C F	x x	x x	* CR
3	2	2	2	2

Process code	Specifies the Read/Write Head with which to communicate. 00: Read error information 01: Clear error information
--------------	-----------------------------------------------------------------------------------------------------------------------

Response

Controller No.	Command code	End code	Most recent error log information	FCS	Terminator
@ x x	C F	0 0	R D 1 7 0) R D 1 4	x x	* CR
3	2	2	n	2	2

End code	Indicates the results of command execution. 00: Normal end Refer to <i>End Codes</i> for more information.  p.133
Most recent error log information	The most recent 30 error records from the error log. The most recent error log information is arranged in the order of occurrence. Five characters are used for each error. <div style="margin-left: 40px;"> <p>RD 1 70</p> <ul style="list-style-type: none"> — Error code — Error head number (for communications errors with Data Carriers only) A space will be returned for errors other than communications errors with Data Carriers. — Error command </div>

COMMUNICATIONS CONDITIONS SETTING (TR)

TR sets conditions for serial communications. After modifying a setting it is necessary to restart the ID Controller or execute the ABORT command (XZ) to enable operating with the modified setting.



CHECK!

Setting communications conditions with this command is enable only when internal settings are enabled (i.e., when SW3 pin 1 is ON).

1:1 Communications

Command

Command code		Baud rate setting	Data length setting	Parity check setting	Stop bit setting	Terminator
T	R	x	x	x	x	* CR
		2	1	1	1	2

Baud rate setting	Sets the baud rate. 0: 1,200 bps 1: 2,400 bps 2: 4,800 bps 3: 9,600 bps 4: 19,200 bps 5: 38,400 bps Default setting: 2,400 bps
Data length setting	Sets the data length. 7: 7 bits 8: 8 bits Default setting: 7 bits
Parity check setting	Sets the parity check method. 0: No parity 1: Odd parity 2: Even parity Default setting: Even parity
Stop bit setting	Sets the number of stop bits. 1: 1 bit 2: 2 bits Default setting: 2 bits

Response

Command code		End code	Terminator
T	R	0 0	* CR
		2	2

End code	Indicates the results of command execution. 00: Normal end Refer to <i>End Codes</i> for more information. p.133
----------	---------------------------------------------------------------------------------------------------------------------------

■ 1:N Communications

Command

Controller No.	Command code		Baud rate setting	Data length setting	Parity check setting	Stop bit setting	FCS		Terminator	
@	x	x	T	R	x	x	x	x	*	CR
3			2	1	1	1	2	2		

Baud rate setting	Sets the baud rate. 0: 1,200 bps 1: 2,400 bps 2: 4,800 bps 3: 9,600 bps 4: 19,200 bps 5: 38,400 bps Default setting: 2,400 bps
Data length setting	Sets the data length. 7: 7 bits 8: 8 bits Default setting: 7 bits
Parity check setting	Sets the parity check method. 0: No parity 1: Odd parity 2: Even parity Default setting: Even parity
Stop bit setting	Sets the number of stop bits. 1: 1 bit 2: 2 bits Default setting: 2 bits

Response

Controller No.	Command code		End code		FCS		Terminator	
@	x	x	0	0	x	x	*	CR
3			2	2	2	2		

End code	Indicates the results of command execution. 00: Normal end Refer to <i>End Codes</i> for more information.  p.133
----------	---------------------------------------------------------------------------------------------------------------------------------------------------------------------------------------------------------------

PARAMETER SETTING (SP)

PARAMETER SETTINGS sets communications conditions for Data Carriers. It can be used to set all ID Controller parameters.

1:1 Communications

Command

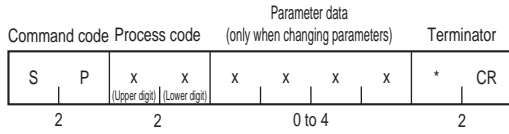

Process code upper digit	Specifies the processing to perform on the parameters. 0: Change internal settings. 1: Read internal settings. 9: Initialize internal settings.	
Process code lower digit	Specifies the parameter. 1: Controller number (See note.) 2: Write verification (See note.) 3: Communications mode (See note.) 4: Auto Command abort time 5: Test switch 6: Response delay time 7: Communications retries 8: Character interval monitoring time 9: Communications mode (See note.) A: Seven-segment output mode (See note.) B: Lower trigger execution enable (See note.) C: Error output time	
Parameter data (only when changing parameters)	Data No. (See note.)	Settable values
	1	Specify as a two-digit decimal number. 00 to 31 (controller number) Default: 00
	2	0: Do not verify. 1: Verify (default)
	3	0: Distance Priority Mode (default) 1: Speed Priority Mode
	4	Specify as a two-digit decimal number. 00 to 99 (s) 00: Not monitored, Default: 00 (s)
	5	0: Disabled 1: Enabled (default)
	6	Specify as a two-digit decimal number. 00 to 99 (ms) 00: No delay, Default: 20 (ms)
	7	Specify as a two-digit decimal number. 00 to 99 (retries) 00: No retries, Default: 09 (retries)
	8	Specify as a four-digit decimal number. 0000 to 9999 (ms) 00: Not monitored, Default: 0099 (ms)
	9	0: 1:1 communications (default) 1: 1:N communications
	A	0: End code display (default) 1: I/O display
	B	0: Disabled (default) 1: Enabled
	C	Specify as a four-digit decimal number. 0000 to 9999 (ms) 0000: Infinite, Default: 0500 (ms)

Note: Parameters 1, 2, 3, 9, A, and B are valid only when internal settings are enabled (i.e., when SW3 pin 1 is ON).

Note: The data numbers for parameter data are the numbers specified for the lower digit of the process code. Set a value that is settable for the parameter specified in the lower digit of the process code.

Response

Command code		End code		Parameter data				Terminator	
S	P	0	0	x	x	x	x	*	CR
2		2		1 to 4				2	

End code	Indicates the results of command execution. 00: Normal end Refer to <i>End Codes</i> for more information.  p.133
Parameter data	The parameter data when parameter setting are read.

1:N Communications

Command

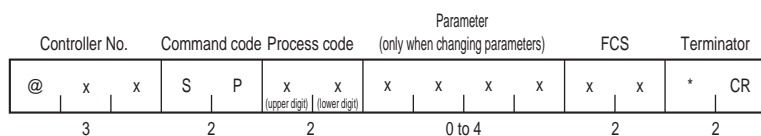

Process code upper digit	Specifies the processing to perform on the parameters. 0: Change internal settings. 1: Read internal settings. 9: Initialize internal settings.	
Process code lower digit	Specifies the parameter. 1: Controller number (See note.) 2: Write verification (See note.) 3: Communications mode (See note.) 4: Auto Command abort time 5: Test switch 6: Response delay time 7: Communications retry time 8: Character interval monitoring time 9: Communications mode (See note.) A: Seven-segment output mode (See note.) B: Lower trigger execution enable (See note.) C: Error output time	
Parameter data (only when changing parameters)	Data No. (See note.)	Settable values
	1	Specify as a two-digit decimal number. 00 to 31 (controller number) Default: 00
	2	0: No verification 1: Verify (default)
	3	0: Distance Priority Mode (default) 1: Speed Priority Mode
	4	Specify as a two-digit decimal number. 00 to 99 (s) 00: Not monitored, Default: 00 (s)
	5	0: Disabled 1: Enabled (default)
	6	Specify as a two-digit decimal number. 00 to 99 (ms) 00: No delay, Default: 20 (ms)
	7	Specify as a two-digit decimal number. 00 to 99 (retries) 00: No retries, Default: 09 (retries)
	8	Specify as a four-digit decimal number. 0000 to 9999 (ms) 00: Not monitored, Default: 0099 (ms)
	9	0: 1:1 communications (default) 1: 1:N communications
	A	0: End code display (default) 1: I/O display
	B	0: Disabled (default) 1: Enabled
	C	Specify as a four-digit decimal number. 0000 to 9999 (ms) 0000: Infinite, Default: 0500 (ms)

Note: The data numbers for parameter data are the numbers specified for the lower digit of the process code. Set a value that is settable for the parameter specified in the lower digit of the process code.

Response

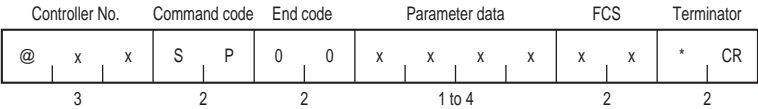

End code	Indicates the results of command execution. 00: Normal end Refer to <i>End Codes</i> for more information.  p.133
Parameter data	The parameter data when parameter setting are read.

Other Commands

Undefined Command Response (IC)

This response is returned when the ID Controller cannot interpret the command code.

1:1 Communications

Response

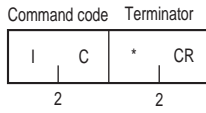

1:N Communications

Response

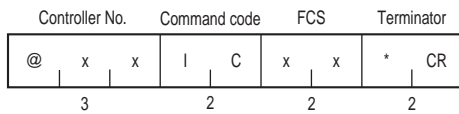

Error Response

When an error occurs during communications with the host computer or during communications with a Data Carrier, an end code is used to indicate the nature of the error.

1:1 Communications

Response

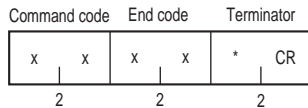

1:N Communications

Response

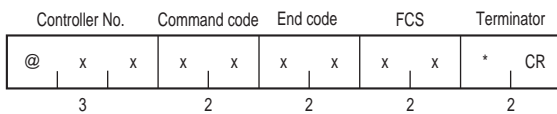

End Codes

End codes are given by two hexadecimal digits.

Type	End code	Name
Normal	00	Normal end code
	74	Polling Command received, Polling Command Check (no results)
	75	Auto Command canceled before a Data Carrier was detected.
		Polling Command canceled before a Data Carrier was detected.
	76	Auto Command canceled after a Data Carrier was detected.
Polling Command canceled after a Data Carrier was detected.		
Host communications errors	10	Parity error
	11	Framing error
	12	Overrun error
	13	FCS error
	14	Format error
		Execution status error
18	Frame length error	
Data Carrier communications errors	70	Data Carrier communications error
	71	Mismatch error
	72	Data Carrier missing error
	76	Copy error
	7A	Address error
	7C	Read/Write Head not connected
	7D	Write-protected
Data Carrier memory warnings	7B	Battery low warning (Replace the battery or Data Carrier.) (See note.)
	75	Normal end code for a MANAGEMENT DATA CHECK/CALCULATE command or MANAGEMENT DATA SUBTRACTION/LIMIT command (not an error)
	76	Error end code for a MANAGEMENT DATA CHECK/CALCULATE command or MANAGEMENT DATA SUBTRACTION/LIMIT command (verification error or overwrite limit exceeded)
System errors	92	Antenna section power supply voltage error
	93	Internal memory error

Note: Data processing has been normally completed for an error code of 7B. If communications are not possible because of a low battery, an error response (e.g., with error code 72 will be returned.)



For more details on errors, refer to *Error Lists*.

CHECK!



p.137

MEMO

Section 6

Troubleshooting

❏ Diagnostic Functions	136
❏ Error Lists	137
❏ Troubleshooting	139
❏ Maintenance and Inspection	140
❏ Troubleshooting Flowcharts	141

Diagnostic Functions

Types of Errors

Fatal Operation Errors

If a CPU error or internal memory error occurs, the RUN/RST indicator will go OFF and the RUN output will turn OFF. If an antenna power supply error occurs, the COM indicator will also light red.

If an antenna power supply voltage error occurs, the RUN/RST indicator will light green. The RUN output will not turn OFF.

Non-fatal Operation Errors

If an error occurs in communications between the ID Controller and host device or in communications between a Read/Write Head and Data Carrier, the error code will be displayed on the monitor display. (Assuming the ID Controller is in Error Code Display Mode.) Up to 30 error records will be saved in the error log in the ID Controller and can be read using commands from the host device.

Indicator and Output Status during Operation

Status	Indicators					Monitor display	Output terminals				
	RUN/RST	COMM	COMM1 COMM2	NORM1/ERR1 NORM2/ERR2	RUN		BUSY	ERROR	OUT1	OUT2	
Test	Data Carrier communications being processed	○	●	○	●	---	ON	OFF	OFF	---	---
	Data Carrier communications processing interval	○	●	●	●	---	ON	OFF	OFF	---	---
	Normal Data Carrier communications	○	●	●	○	End code	ON	OFF	OFF	---	---
	Error in Data Carrier communications	○	●	●	●	Error code	ON	OFF	ON	---	---
RUN	Waiting for data send/receive	○	●	●	●	---	ON	OFF	---	---	---
	Sending/receiving data	○	○	○	●	---	ON	ON	OFF	OFF	OFF
	Normal Data Carrier communications	○	●	●	○	End code	ON	OFF	OFF	USR	USR
	Host communications error	○	●	●	●	Error code	ON	OFF	ON	OFF	OFF
	Error in Data Carrier communications	○	●	●	●	Error code	ON	OFF	ON	OFF	OFF
Fatal error	CPU error	●	●	●	●	---	OFF	OFF	OFF	OFF	OFF
	Antenna power supply error	○	●	●	●	92	ON	OFF	OFF	OFF	OFF
	Internal memory error	●	●	●	●	93	OFF	OFF	OFF	OFF	OFF
Emergency stop	○	●	●	●	---	OFF	OFF	OFF	OFF	OFF	

● : Not lit ○ : Lit green ○ : Lit yellow ● : Lit red

USR: Set using the CONTROLLER CONTROL command.

Error Lists

Host communications error

Type	Error code	Name	Description
Errors in communications with host device	10	Parity error	An error occurred in communications between the host device and ID Controller.
	11	Framing error	• Error in setting the communications format • Malfunction due to noise
	12	Overrun error	
	13	FCS error	There is an error in FCS calculations.
	14	Command input error	There is an error in the command format.
	18	Frame length error	There are too many characters in one command frame.
Errors in communications with Data Carrier	70	Data Carrier communications error	An error occurred in communications between a Read/Write Head and Data Carrier. • Problem in setting, e.g., passing speed or distance. • Malfunction due to obstacle
	71	Mismatch error	Read or write processing was not performed correctly.
	72	Data Carrier missing	There was no Data Carrier in the communication area when a read or write was executed.
	76	Copy error	Copy processing was not performed correctly.
	7A	Address error	An address exceeding the Data Carrier memory was specified. The area start address was not specified correctly for the MDS/MDL command.
	7C	Read/Write Head not connected	A Read/Write Head is not connected.
	7D	Write-protected	The manufacturing date area or a right-protected area was specified for a Write Command.

- Host communications errors are errors that occur in communications between the host device and ID Controller.
- Data Carrier communications errors are errors that occur in communications between a Read/Write Head and the ID Controller.
- All of these errors are recorded in the ID Controller and error codes are displayed on the monitor display. The recorded errors can also be read using the ERROR READ command (CF).

Note: If a Data Carrier communications error (error code 70), mismatch error (error code 71), or copy error (error code 76) occurs during execution of a Write Command, the addresses specified to be written for the command may be partially or completely overwritten. The data that is overwritten may not be the data specified for the Write Command. If a Data Carrier communications error (error code 70), mismatch error (error code 71), or copy error (error code 76) occurs during execution of a Write Command, continue retry processing from the host device until the command is completed with no error. No data other than the addresses specified to be written in the command will be affected.

Warning code	Name	Description
7B	Data Carrier battery low	A battery life warning for a Data Carrier with a built-in battery.
76	Data Carrier overwrite count exceeded	An overwrite count exceeded warning for a MANAGEMENT DATA SUBTRACTION or MANAGEMENT DATA LIMIT command (MDS or MDL).
	Data Carrier memory check error	A memory error detected warning for a MANAGEMENT DATA CHECK command (MDC).

- These warnings are not recorded in the ID Controller.

System Errors

Error code	Name	Description
92	Antenna power supply voltage error	The voltage supplied to the Read/Write Head from the ID Controller has dropped. <ul style="list-style-type: none">• Prepare a replacement ID Controller.
93	Memory error	A memory may have occurred in the ID Controller or noise may have caused an error. <ul style="list-style-type: none">• Reset the power supply.• Turn ON the RESET input.• Use the SP command to reset communications with the Data Carrier. (Prepare a replacement if normal communications cannot be recovered.)

Troubleshooting

There are four major causes of ID Controller problems:

- Influence of noise.....Take countermeasures against noise.
 - Malfunctioning of external devices }
 - Malfunctioning of ID Controller }
 - Other }
-Repair is required.

■ Influence of Noise

If the system malfunctions due to noise, take appropriate countermeasures against noise by referring to the following table.

No.	Occurrence	Possible cause	Countermeasures
1	Problem occurred when power was turned ON to high-capacity motor, transformer, capacitor, etc.	Momentary voltage drop due to inrush current of large load	Increase the capacity of the power supply or use larger power cables.
		Common noise cause by the above	<ul style="list-style-type: none"> • Supply power through a 1:1 non-grounded insulated transformer. • Do not share the ground lines with other high-capacity loads. Independently ground to less than 100 Ω. (Figure 1)
2	Irregular problems	Noise superimposed on power lines	Supply power through a 1:1 non-grounded insulated transformer or noise filter. (Figure 2)
3	Input signal turns ON when it should be OFF.	Inductive noise on input wiring	<ul style="list-style-type: none"> • Separate input signal lines from other power lines. • If the influence of noise is strong, route input lines using a grounded metal conduit or use shielded cables.

1. Improving Grounding

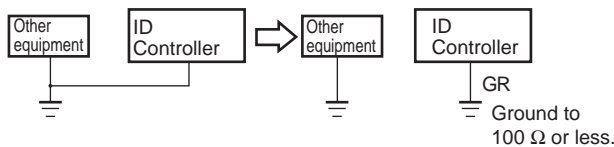

2. Countermeasures against Power Supply Noise

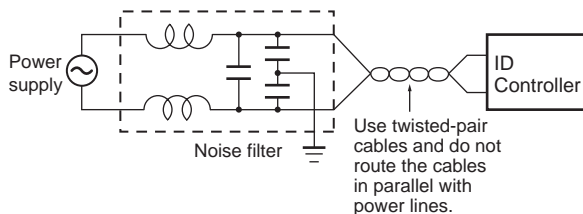

Maintenance and Inspection

To keep the ID Controller in the best condition, the ID Controller should be inspected daily or periodically. Although the ID Controller consists of semiconductor devices, the following problems may occur depending on the environment and conditions in which the ID Controller is operated.

1. Degradation of elements due to overcurrents and overvoltages
2. Degradation of elements due to long-term stress caused by using ID Controller at high temperatures
3. Degradation of insulation and faulty connector contact due to humidity and dust
4. Faulty connector contact or corrosion due to corrosive gas

■ Inspection Items

No.	Inspection item	Details	Criteria	Remarks
1	Power supply voltage fluctuations	1. Voltage measured at power supply terminal block within rated range?	Supply voltage must be within rated range.	Voltage tester
		2. Momentary power failures occur frequently? Abrupt rises in supply voltage occur?	Supply voltage fluctuations must be within rated range.	Power analyzer
2	Ambient conditions			Thermometer and hygrometer
	(a) Temperature	(a) Must be within rated values.	(a) -10 to 55°C	
	(b) Humidity	(b) Must be within rated values.	(b) 35% to 85%	
	(c) Vibration and shock	(c) Is vibration or shock being transmitted from the equipment?	(c) Must be within ratings.	
	(d) Dust and dirt	(d) Is dust, dirt, or foreign objects collecting on the Controller?	(d) Must be free from dust, dirt, and foreign objects.	
(e) Corrosive gas	(e) Are the metallic parts discolored or corroded?	(d) Must be free from discoloration and corrosion.		
3	Control Panel Conditions			---
	(a) Is ventilation good?	(a) Is natural ventilation, forced ventilation, or air conditioning adequate?	(a) Good ventilation is essential. Temperature in panel must be -10 to 55°C.	
	(b) Is packing damaged in a sealed panel?	(b) Is panel packing loose or damaged?	(b) Packing must be free from damage.	
4	I/O power			Voltage tester and oscilloscope
	(a) Voltage fluctuations (b) Ripple	Is voltage measured at each I/O terminal within rated level?	Supply voltage must be within rated range.	
5	Mounting conditions	(1) Is each device mounted securely?	There must be no looseness.	---
		(2) Are connectors inserted securely?	Connectors must be locked and tightened with screws.	---
		(3) Are terminal block screws loose?	There must be no loose screws.	---
		(4) Is the wiring damaged?	Wiring must be free from damage.	---
		(5) Are the communications specifications between Data Carrier and Read/Write Head satisfied?	Specifications must be within rated ranges.	---
6	Data Carrier service life confirmation	Check the manufacturing data of the Data Carriers with built-in batteries.	The battery service life must not be exhausted.	---
		Check the overwrite count of Data Carriers without batteries.	The overwrite count must not exceed the limit.	---
7	Error log check	Check the error log	---	---

Troubleshooting Flowcharts

If a malfunction has occurred, carefully investigate the surrounding conditions and check whether the trouble persists or is related to other equipment. Then troubleshoot the malfunction according to the following flowcharts.

Main Check Flowchart

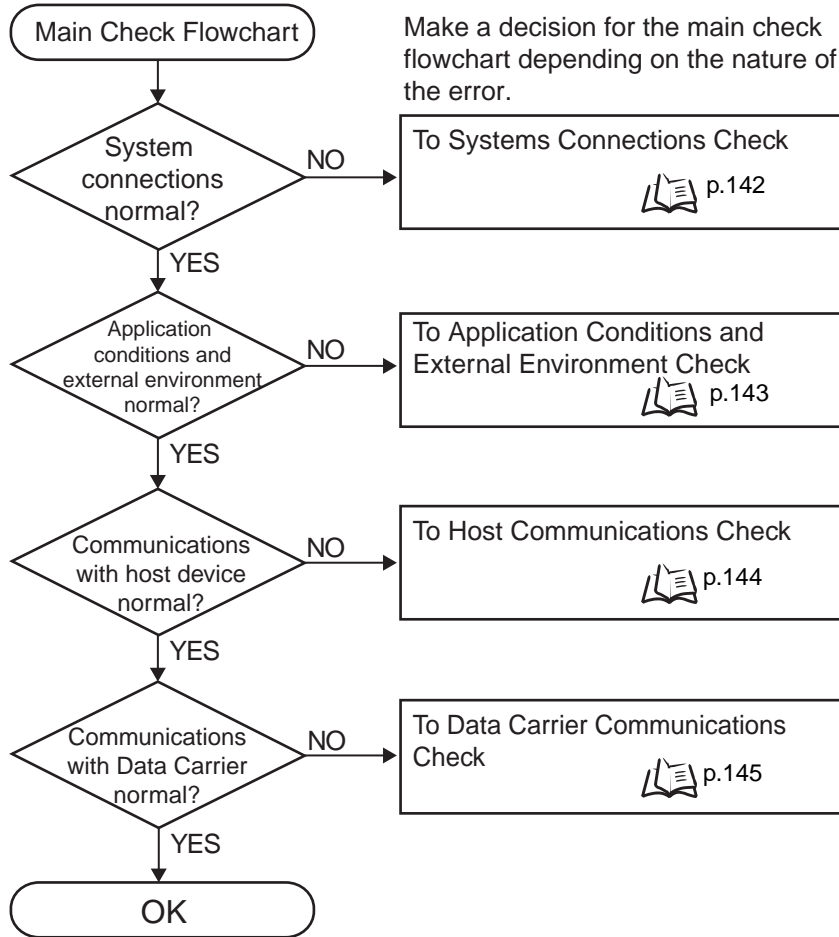

Systems Check Flowchart

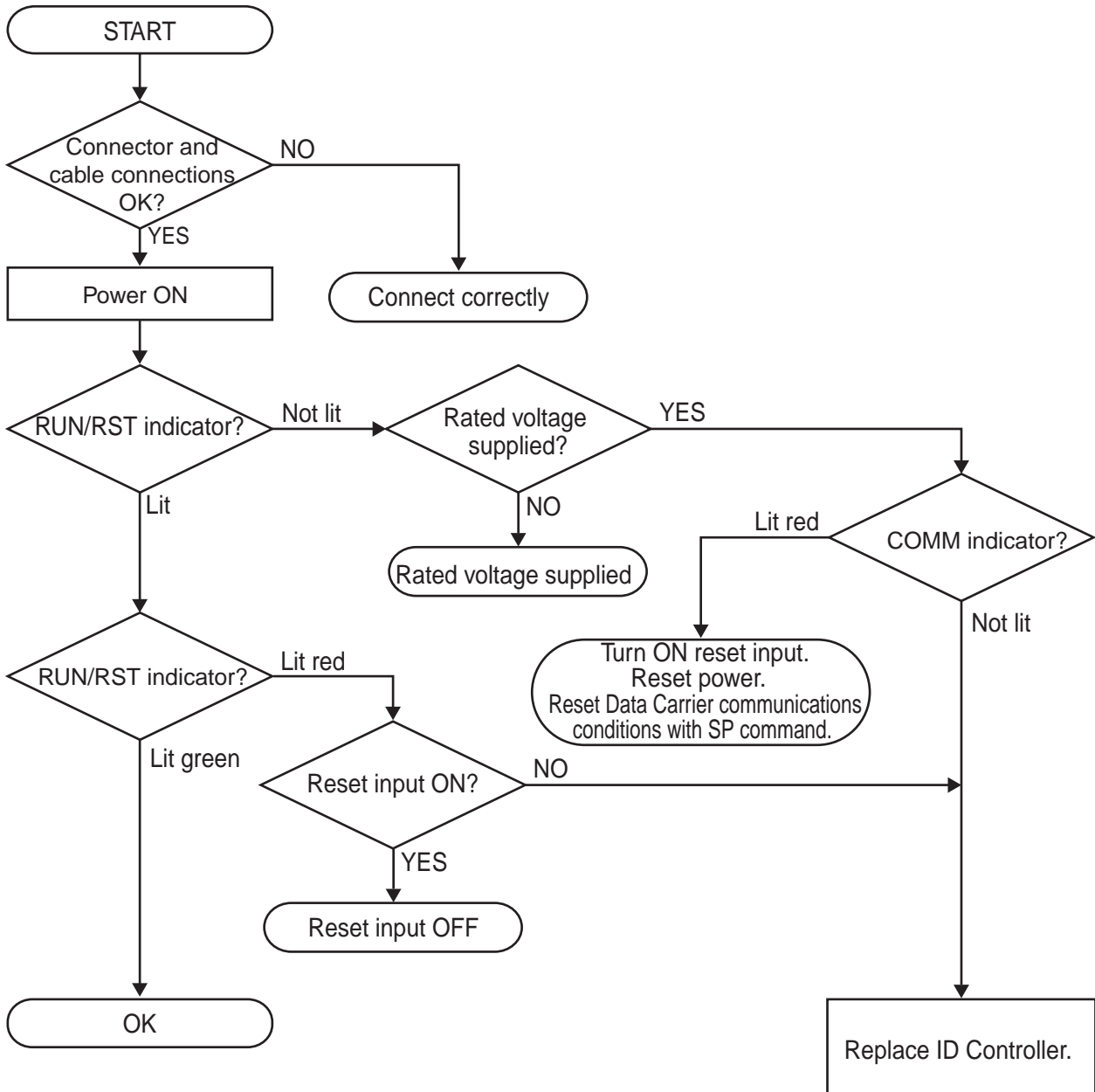

Application Conditions and External Environment Check

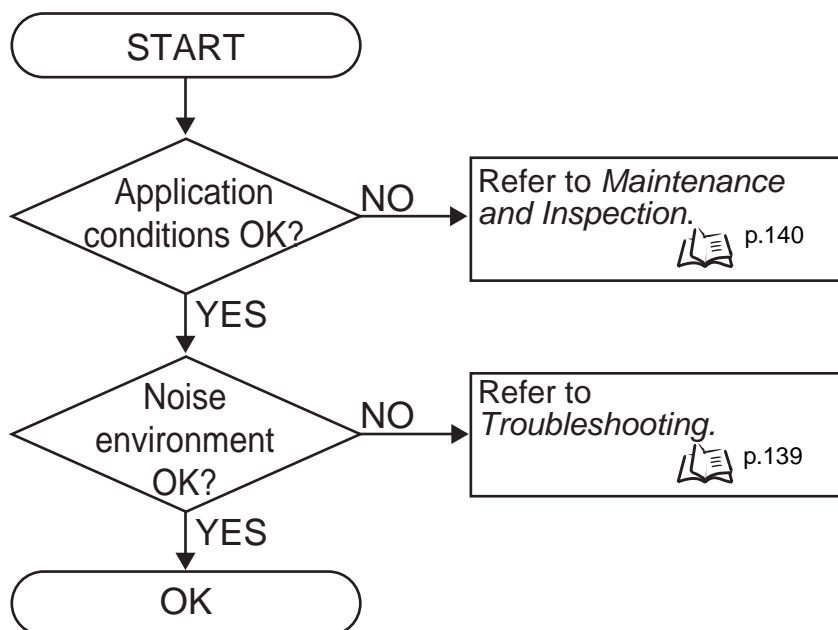

Host Communications Check

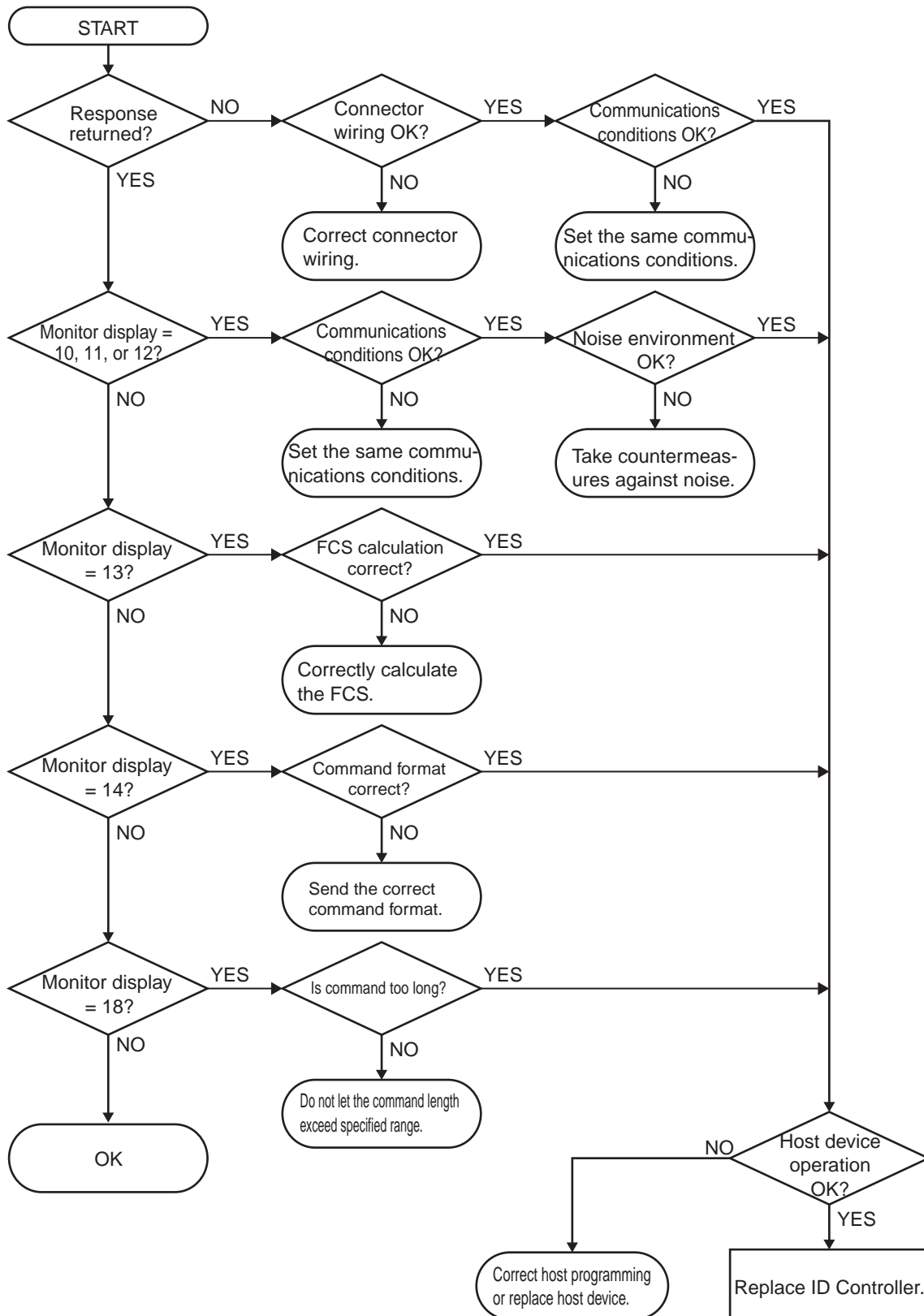

Data Carrier Communications Check

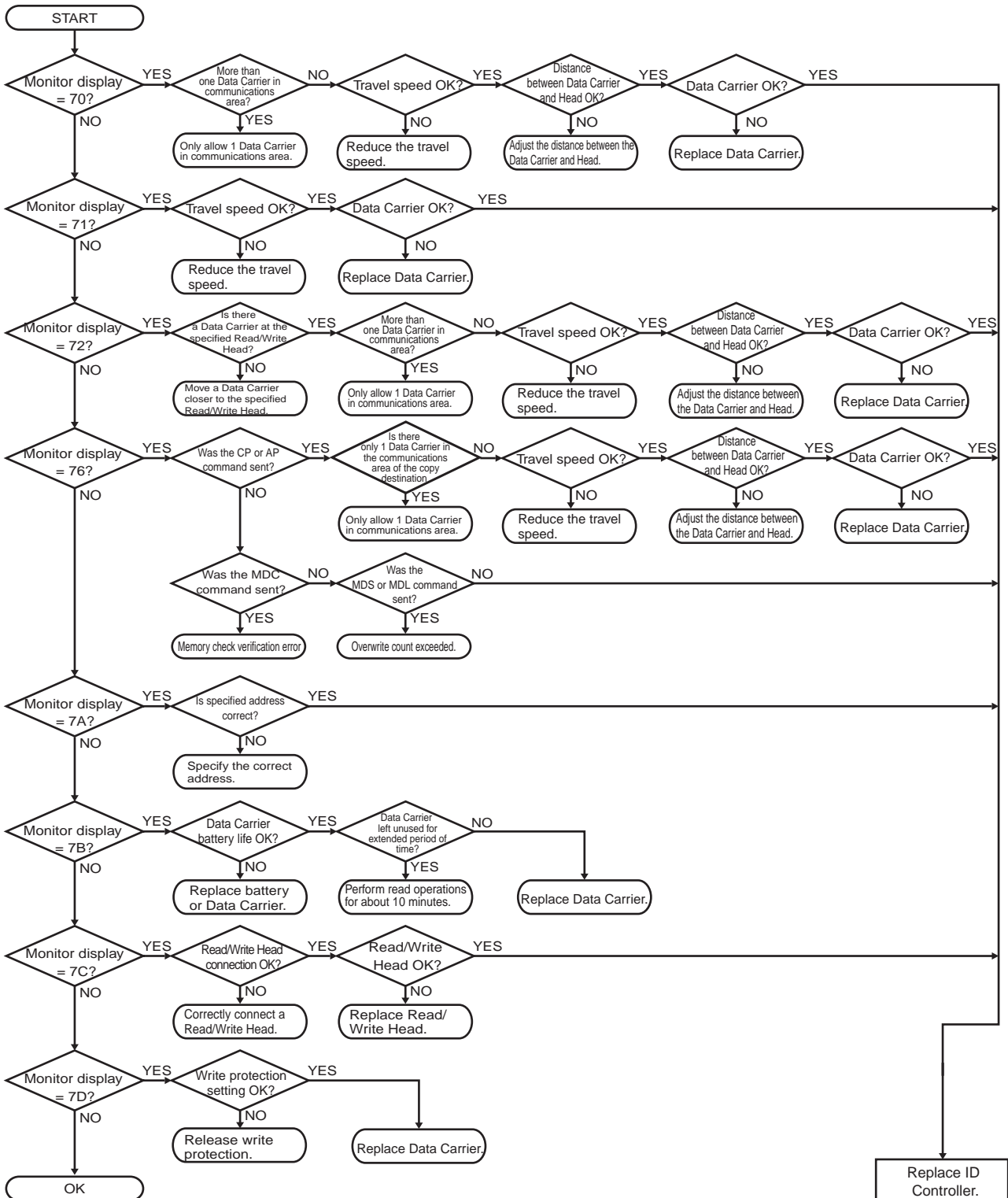

MEMO

Section 7

Appendix

☒ Specifications and Dimensions	148
☒ Characteristics According to Application Conditions	151
☒ Data Carrier Memory Map	157
☒ Data Carrier Memory Capacities and Memory Types	158
☒ ASCII Table	159
☒ Degree of Protection	160

Specifications and Dimensions

General Specifications

Item	Specification
Power supply voltage	24 VDC (-15% to 10%)
Power consumption/current consumption	Power consumption: 15 W, current consumption: 0.8 A
Ambient operating temperature	-10 to 55° C (with no icing)
Ambient operating humidity	25% to 85% (with no condensation)
Ambient storage temperature	-25 to 65° C (with no icing)
Ambient storage humidity	25% to 85% (with no condensation)
Insulation resistance	Between power supply terminals and GR/case } 20 MΩ min. (at 500 VDC) Between GR and terminals }
Dielectric strength	For all combinations given above: 1,000 VAC 50/60 Hz for 1 minute, leakage current: 10 mA max.
Vibration resistance	10 to 150 Hz with 0.2 mm double amplitude and 15-m/s ² maximum acceleration, 10 sweeps of 8 minutes each in three directions
Shock resistance	150 m/s ²
Dimensions	105 × 90 × 65 mm (excluding protrusions)
Degree of protection	In-panel (equivalent to IP20)
Materials	PC+ABS
Weight	Approx. 300 g
Installation method	DIN Rail or M4 screws
Read/Write Head Connections	2 channels

Communications specifications

Item	Specification	
	RS-232C	RS-422/RS-485
Connector specifications	9-pin D-Sub connector, socket lock screws: M2.6	5-pin connector manufactured by Phoenix Contact MC1.5/5GF-3.5
Communications method	Half-duplex serial communications	4/2-wire half-duplex serial communications
Baud rate	38400, 19200, 9600, 4800, 2400, or 1200 bps	
Data length	7 or 8 bits	
Stop bits	1 or 2 bits	
Error detection	Parity (even, odd, or none)	
Cable length	15 m max.	Total length: 500 m max.

I/O Specifications

● Input Specifications (RST, TRG/IN1, and TRG/IN2)

Input voltage	24 VDC +10% (including ripple)/ -15% (PNP or NPN)
Input impedance	2.2 kΩ
Input current	10 mA typical (24 VDC)
ON voltage	19 V max.
OFF voltage	5 V max.
I/O response time	70 ms max.

● Output Specifications (RUN, BUSY, ERROR, OUT1, and OUT2)

Maximum switching capacity	24 VDC +10% (including ripple)/-15% 100 mA photo MOS outputs (PNP or NPN)
Leakage current	100 mA max.
Residual voltage	2.0 V max.

Note 1: The CPU will stop operation and the RST indicator will light when the RST input is turned ON.

2: The transistor may be damaged if an output is shorted with no load connected.

I/O Device Wiring Examples

Inputs

- PLC Output Unit (e.g., C200H-OD21 or C500-OD412)
- NPN Transistor Open-collector Output (e.g., from a 3-wire Sensor)
- Device with contact (e.g., pushbutton switch)

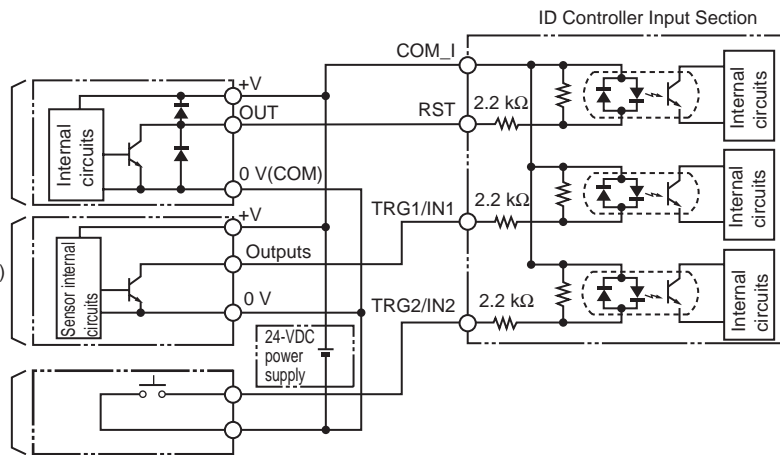

Outputs

- PLC Input Unit (e.g., C200H-ID212 or C500-ID218)
- Relay

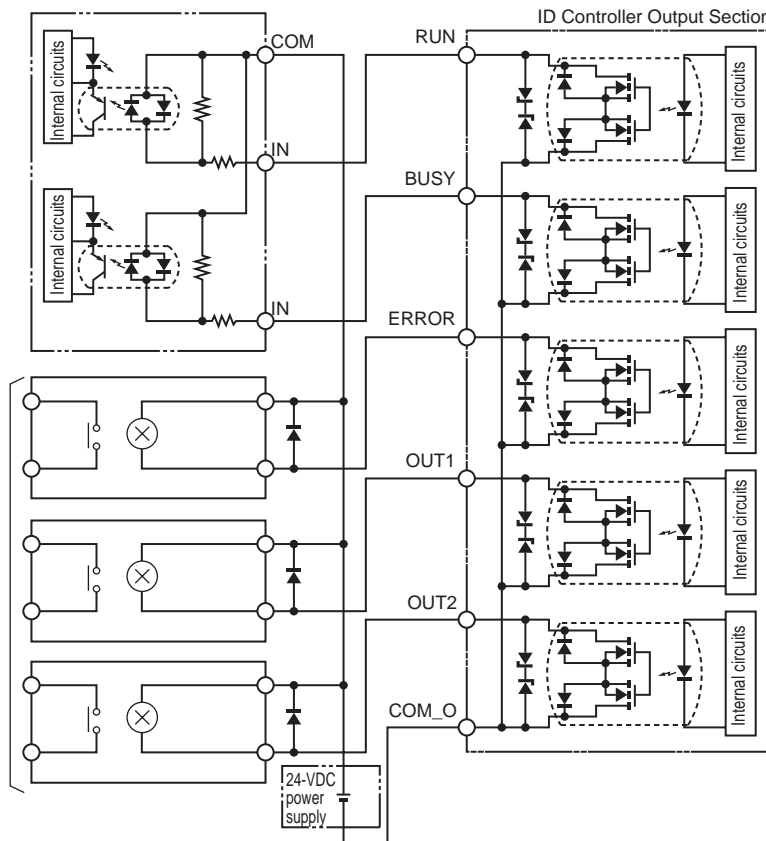

Dimensions

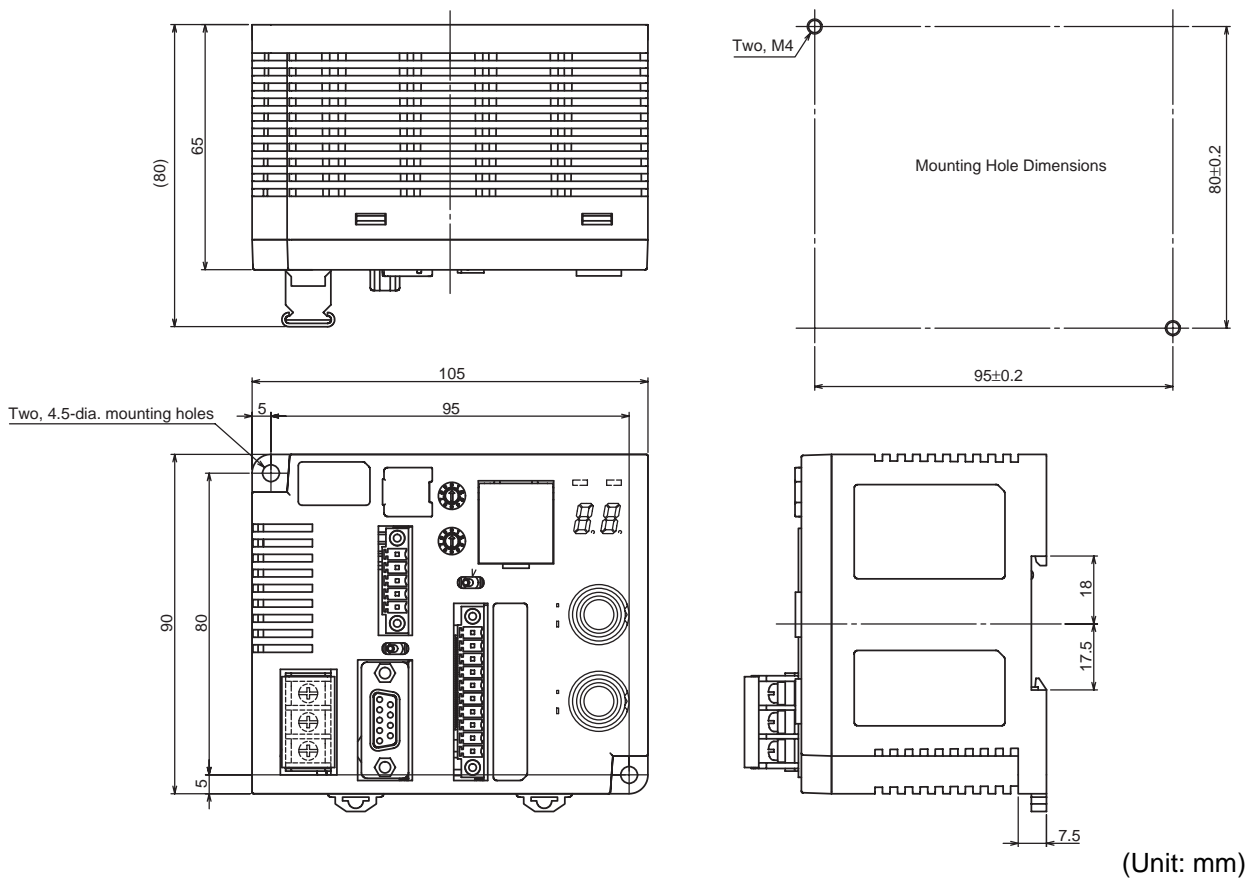

Characteristics According to Application Conditions

Communications Area Diagram (Reference)

The communications area of the V600-CA5D02 is shown below. The communications area depends on installation and environment conditions.

- V600-H11 to V600-D23P66N

The communications diagram indicates the communications area consisting of a flat plane perpendicular to the antenna and running through the center of the Read/Write Head. The surface of the Data Carrier is parallel to the surface of the antenna.

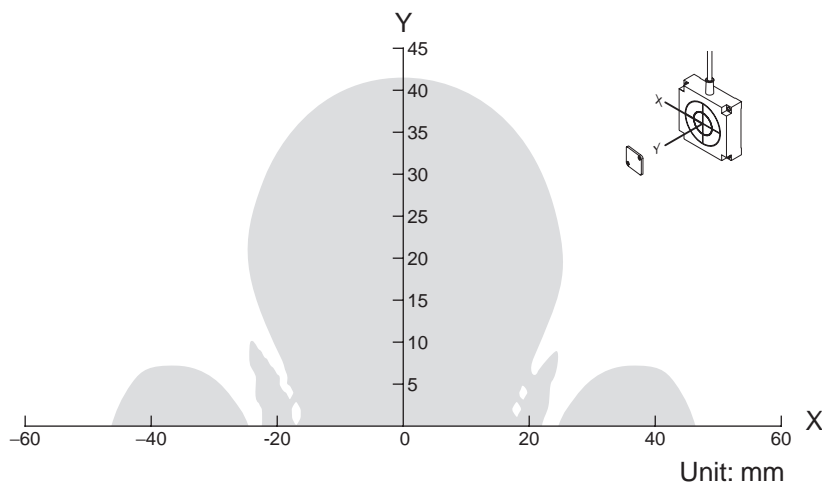

Host Communications Time and Data Carrier Communications Time

Data Carrier Communications Time

- The communications time with a Data Carrier depends on the type of Data Carrier being used (with or without a built-in battery).
- The communications time of Data Carriers without batteries also depends on the communications mode setting.

Data Carriers with Built-in Batteries (Reference)

Communications Time with Data Carriers

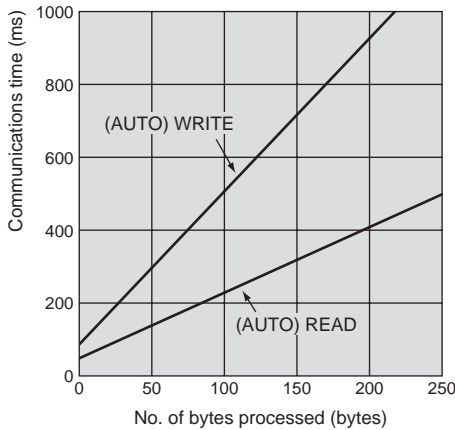

Calculations

	Communications time (ms)
Reading	$T=1.8N+48.4$
Writing	$T=4.2N+86.5$

N: No. of bytes processed

Data Carriers without Built-in Batteries (Reference)

1) Communications Distance Priority Mode (SW4 Pin 1 OFF)

Communications Time with Data Carriers

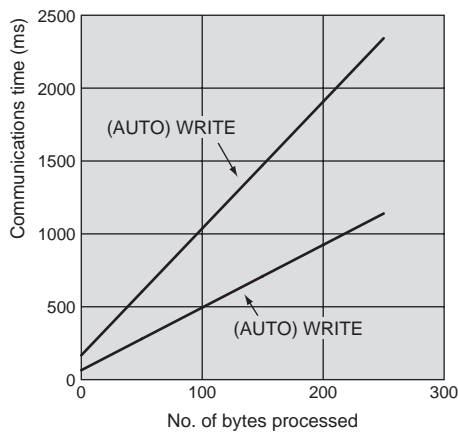

Calculations

	Communications time (ms)
Reading	$T=4.3N+64.6$
Writing	$T=8.7N+167.1$

N: No. of bytes processed

2) Communications Time Priority Mode (SW4 Pin 1 OFF)

● Communications Time with Data Carriers

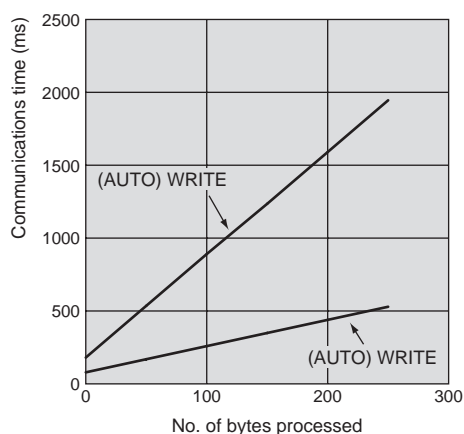

Calculations

	Communications time (ms)
Reading	$T=1.8N+79.0$
Writing	$T=7.1N+180.4$

N: No. of bytes processed

■ TAT (Turn Around Time)

- The TAT depends on the type of Data Carrier being used (with or without a built-in battery).
- The TAT of Data Carriers without batteries also depends on the communications mode setting.
- The TAT is the total time required for the host device to receive a response after it has finished sending a command.

$$\text{TAT} = \text{Command send time} + \text{Data Carrier communications time} + \text{Response reception time}$$

Command send time : The time required to send a command from the host device to the ID Controller. The command send time depends on the baud rate and communications format.

Data Carrier communications time : The time required for communications processing between the Read/Write Head and Data Carrier. Refer to the next page to find the values.

Response reception time : The time required to return a response to the host device from the ID Controller. The command send time depends on the baud rate and communications format.

■ Normal Commands

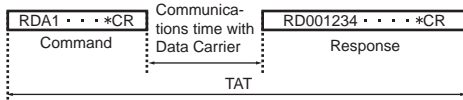

■ EXPANSION READ Command

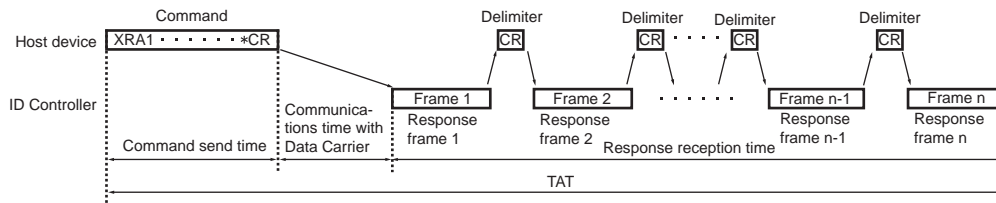

■ EXPANSION WRITE Command

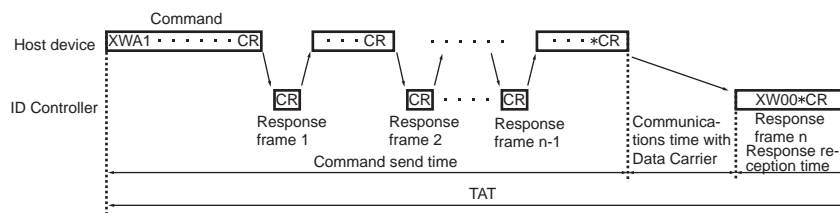

▪ Data Carriers with Built-in Batteries (Reference)

● TAT

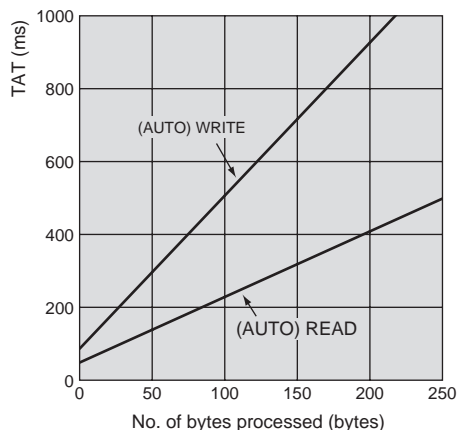

Calculations

	TAT (ms)
Reading	$T=2.9N+69.8$
Writing	$T=5.3N+105.6$

N: No. of bytes processed

▪ Data Carriers without Built-in Batteries (Reference)

1) Communications Distance Priority Mode (SW4 Pin 1 OFF)

● TAT

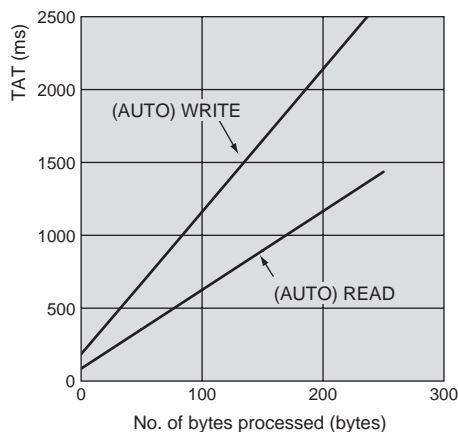

Calculations

	TAT (misc.)
Reading	$T=5.4N+85.4$
Writing	$T=9.8N+184.9$

N: No. of bytes processed

2) Communications Time Priority Mode (SW4 Pin 1 ON)

● TAT

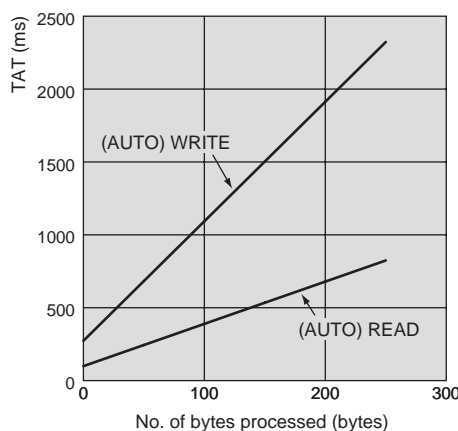

Calculations

	TAT (misc.)
Reading	$T=2.9N+99.1$
Writing	$T=8.2N+272.9$

N: No. of bytes processed

- Note 1. TAT data is for a V600-CA5D02 ID Controller using a baud rate of 9600 bps, 8-bit data, 1 stop bit, and odd parity. Characters are sent continuously with no interruptions.
2. The number of bytes of TAT data is for ASCII data.

Data Carrier Speed

Use Auto Command and Polling Commands to communicate with moving Data Carriers. The maximum speed of Data Carrier when executing these commands can be calculated simply using the following formula.

$$\text{Max. Data Carrier speed} = \frac{D \text{ (Distance traveled in the transmission range (m))}}{T \text{ (Data Carrier communications time)}} \times \text{Safety factor (0.5)}$$

D can be obtained from the communications area diagram between the Read/Write Head and Data Carrier or actually measured.

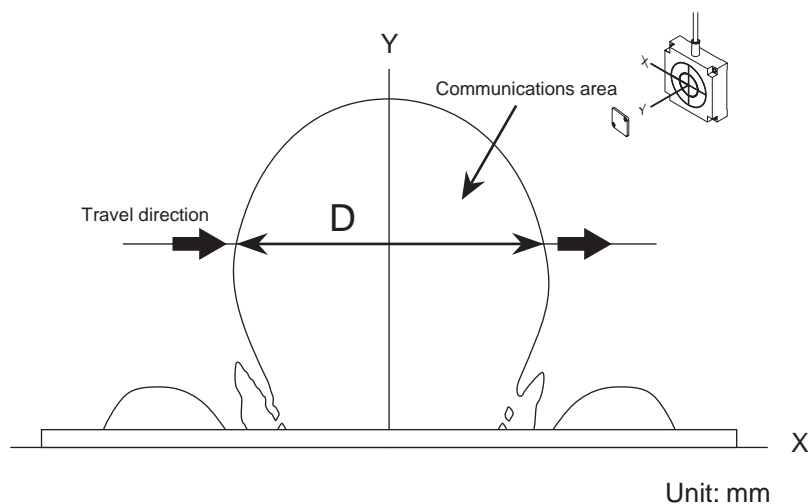

Data Carrier Memory Map

Data Carriers without Batteries

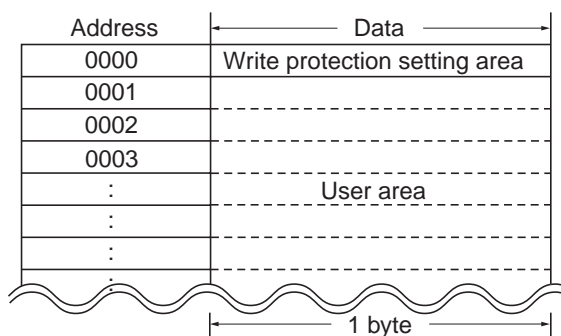

Data Carriers with Built-in Batteries

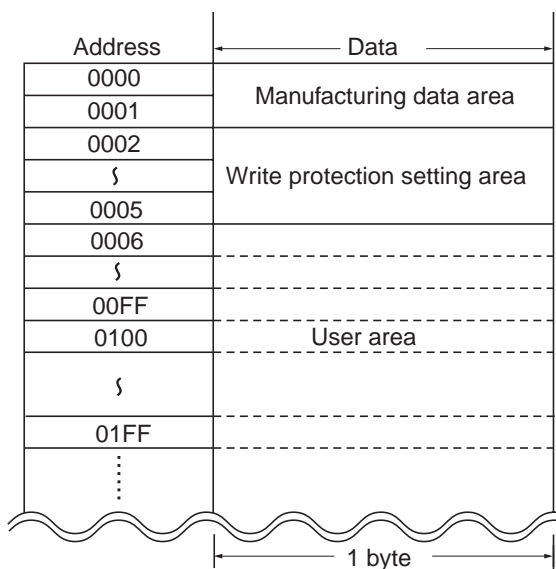

Refer to *Data Carrier Memory Capacities and Memory Types* for information on Data Carrier memory capacities and memory types.

Data Carrier Memory Capacities and Memory Types

(As of September 2005)

Model	Memory capacity (user memory)	Memory type	Service life
V600-D8KR12 V600-D8KR13 V600-D8KR04	8 KB	SRAM	5 to 8 years (See note.)
V600-D2KR16	2 KB	SRAM (replace-able battery)	2 years at 25°C
V600-D23P53 V600-D23P54 V600-D23P55 V600-D23P61 V600-D23P71 V600-D23P72 V600-D23P66N V600-D23P66SP	254 bytes	EEPROM	Overwrites: 100,000 Overwrites with an ambient temperature between the minimum temperature and 40°C: 300,000 Data holding time: 10 years
V600-D8KF04	8 KB	Fe-RAM	Overwrites: 1,000,000,000 Data holding time: 10 years

Note: Battery service life depends on the number of communications bytes and the number of communications per day. Refer to the *Read/Write Head/Data Carrier Manual* (Cat. No. Z127) for details.



A lithium battery is built into SRAM Data Carriers with built-in batteries and may occasionally cause serious injury due to combustion, explosion, or burning. Dispose of the Product as industrial waste and never disassemble it, expose it to pressures that would distort it, heat it to temperatures above 100°C, or incinerate it.



ASCII Table

Lower digit	Upper digit	b8 to b5		0000	0001	0010	0011	0100	0101	0110	0111	1000	1001	1010	1011	1100	1101	1110	1111
		b4 to b1	Column	0	1	2	3	4	5	6	7	8	9	10	11	12	13	14	15
		Row																	
0000	0	NUL	TC7(DLE)	(SP)	0	@	P	`	p										
0001	1	TC1(SOH)	DC1	!	1	A	Q	a	q										
0010	2	TC2(STX)	DC2	"	2	B	R	b	r										
0011	3	TC3(ETX)	DC3	#	3	C	S	c	s										
0100	4	TC4(EOT)	DC4	\$	4	D	T	d	t										
0101	5	TC5(NEQ)	TC8(NAK)	%	5	E	U	e	u										
0110	6	TC6(ACK)	TC9(SYN)	&	6	F	V	f	v										
0111	7	BEL	TC10(ETB)	'	7	G	W	g	w										
1000	5	FE0(BS)	CAN	(8	H	X	h	x	Undefined	Undefined	Undefined	Undefined	Undefined	Undefined	Undefined	Undefined	Undefined	Undefined
1001	9	FE1(HT)	EM)	9	I	Y	i	y										
1010	10	FE2(LF)	SUB	*	:	J	Z	j	z										
1011	11	FE3(VT)	ESC	+	;	K	[k	{										
1100	12	FE4(FF)	IS4(FS)	.	<	L	\	l											
1101	13	FE5(CR)	IS3(GS)	-	=	M]	m	}										
1110	14	SO	IS2(RS)	.	>	N	^	n	~										
1111	15	SI	IS1(US)	/	?	O	_	o	DEL										

Note Do not use the undefined areas.

Degree of Protection

Ingress protection degrees (IP-□□) are determined by the following tests. Be sure to check the sealing capability under the actual operating environment and conditions before actual use.

■ IEC (International Electrotechnical Commission) Standards (IEC 60529 November 1989)

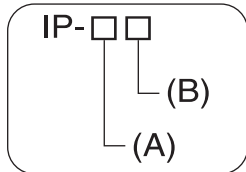









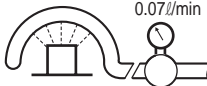

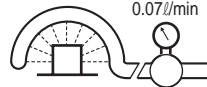
(A) First Number: Degree of Protection from Solid Materials

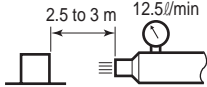
Degree	Protection	
0		No protection.
1		Protects against penetration of any solid object, such as a hand, that is 50 mm or more in diameter.
2		Protects against penetration of any solid object, such as a finger, that is 12.5 mm or more in diameter.
3		Protects against penetration of any solid object, such as a wire, that is 2.5 mm or more in diameter.
4		Protects against penetration of any solid object, such as a wire, that is 1 mm or more in diameter.
5		Protects against penetration of dust of a quantity that may cause malfunction or obstruct the safe operation of the product.
6		Protects against penetration of all dust.

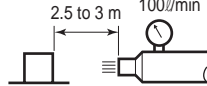
(B) Second Number: Degree of Protection Against Water

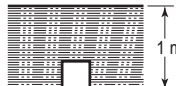
Degree	Protection		Test method (with fresh water)
0	No protection	Not protected against water.	No test
1	Protection against water drops 	Protects against vertical drops of water falling on the product.	Water is dropped vertically towards the product from the test machine for 10 min.
2	Protection against water drops 	Protects against drops of water approaching at a maximum angle of 15° to the left, right, back, and front of vertical towards the product.	Water is dropped for 25 min each (i.e., 10 min in total) towards the product inclined 15° to the left, right, back, and front from the test machine.

Degree	Protection		Test method (with fresh water)	
3	Protection against sprinkled water 	Protects against sprinkled water approaching at a maximum angle of 60° from vertical towards the product.	Water is sprinkled at a maximum angle of 60° to the left and right from vertical for 10 min from the test machine.	Water rate per hole: 0.07//min 
4	Protection against water spray 	Protects against water spray approaching at any angle towards the product.	Water is sprayed at all angles towards the product for 10 min from the test machine.	Water rate per hole: 0.07//min 
5	Protection against water jet spray 	Protects against water jet spray approaching at any angle towards the product.	Water is jet sprayed at all angles towards the product for 1 min per square meter for at least 3 min in total from the test machine.	2.5 to 3 m 12.5//min  Discharging nozzle: 6.3 dia.
6	Protection against high pressure water jet spray 	Protects against high-pressure water jet spray approaching at any angle towards the product.	Water is jet sprayed at all angles towards the product for 1 min per square meter for at least 3 min in total from the test machine.	2.5 to 3 m 100//min  Discharging nozzle: 12.5 dia.
7	Protection underwater 	Resists the penetration of water when the product is placed underwater at specified pressure for a specified time.	The product is placed 1 m deep in water (if the product is 850 mm max. in height) for 30 min.	
8	Protection underwater 	Can be used continuously underwater.	The test method is determined by the manufacturer and user.	

■ JEM (Japan Electrical Manufacturers' Association) Standard JEM 1030: 1991

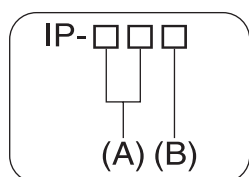

“A” conforms to the first and second numbers of IEC 60529.

(B) Degree of Protection Against Ingress of Oil

Degree	Protection	
f	Oil-proof	No adverse affects from oil drops or oil spray from any direction.
g	Oil-tight	No ingress of oil drops or oil spray from any direction.

Note: Degrees h, c, d, and e are also defined.

Revision History

A manual revision code appears as a suffix to the catalog number on the front cover of the manual.

Cat No. Z239-E1-01A

↑
Revision code

Revision code	Date	Revised contents
01	January 2006	Original production
01A	July 2007	Page 148: Specifications changed

OMRON CORPORATION
Industrial Automation Company

Sensing Devices Division H.Q.
Industrial Sensors Division

Shiokoji Horikawa, Shimogyo-ku,
Kyoto, 600-8530 Japan
Tel: (81)75-344-7022/Fax: (81)75-344-7107

Regional Headquarters

OMRON EUROPE B.V.
Sensor Business Unit,
Carl-Benz-Str. 4, D-71154 Nufringen,
Germany
Tel: (49)7032-811-0/Fax: (49)7032-811-199

OMRON ELECTRONICS LLC
One Commerce Drive Schaumburg, IL 60173
U.S.A.
Tel: (1) 847-843-7900/Fax: (1) 847-843-7787

OMRON ASIA PACIFIC PTE. LTD.
No. 438A Alexandra Road # 05-05/08 (Lobby 2),
Alexandra Technopark,
Singapore 119967
Tel: (65) 6835-3011/Fax: (65) 6835-2711

OMRON (CHINA) CO., LTD.
Room 2211, Bank of China Tower,
200 Yin Cheng Zhong Road,
Pu Dong New Area, Shanghai,
200120, China
Tel: (86)21-5037-2222/Fax: (86)21-5037-2200

OMRON

Authorized Distributor: