

# AXIS 262 Network Video Recorder

## User's Manual

## 2 About This Document

This manual is intended for administrators and users of the AXIS 262 Network Video Recorder. It includes instructions for using and managing the AXIS 262 on your network. Previous experience of networking will be of use when installing and using this product. Later versions of this document will be posted to the Axis Website, as required. See also the product's online help, available via the Web-based interface.

### Safety Notices Used In This Manual

**Caution!** - Indicates a potential hazard that can damage the product.

**Important!** - Indicates a hazard that can seriously impair operation.

Do not proceed beyond any of the above notices until you have fully understood the implications.

### Intellectual Property Rights

This product contains licensed third-party software. See the menu item "About" in the product's user interface for more information.

### Legal Considerations

Video recording can be prohibited by laws that vary from country to country. Check the laws in your local region before using this product for surveillance purposes.

### Electromagnetic Compatibility (EMC)

This equipment generates, uses and can radiate radio frequency energy and, if not installed and used in accordance with the instructions, may cause harmful interference to radio communications. However, there is no guarantee that interference will not occur in a particular installation. If this equipment does cause harmful interference to radio or television reception, which can be determined by turning the equipment off and on, the user is encouraged to try to correct the interference by one or more of the following measures: Re-orient or relocate the receiving antenna. Increase the separation between the equipment and receiver. Connect the equipment to an outlet on a different circuit to the receiver. Consult your dealer or an experienced radio/TV technician for help. Shielded (STP) network cables must be used with this unit to ensure compliance with EMC standards.

**Europe - CE** This digital equipment fulfills the requirements for radiated emission according to limit B of EN55022/1998, and the requirements for immunity according to EN55024/1998 residential, commercial, and light industry.

**Japan** - This is a class B product based on the standard of the Voluntary Control Council for Interference from Information Technology Equipment (VCCI). If this is used near a radio or television receiver in a domestic environment, it may cause radio interference. Install and use the equipment according to the instruction manual.

### Liability

Every care has been taken in the preparation of this manual; Please inform your local Axis office of any inaccuracies or omissions. Axis Communications AB cannot be held responsible for any technical or typographical errors and reserves the right to make changes to the product and manuals without prior notice. Axis Communications AB makes no warranty of any kind with regard to the material contained within this document, including, but not limited to, the implied warranties of merchantability and fitness for a particular purpose. Axis Communications AB shall not be liable nor responsible for

incidental or consequential damages in connection with the furnishing, performance or use of this material. Axis Communications AB cannot be held responsible for any data loss in the event of a hard disk failure.

### Precautions

Please observe the following when using the AXIS 262:

- Operate this unit at the correct voltage (12V DC), using other voltages may cause fire or electrical shock.
- The use of UPS is highly recommended.
- This AXIS 262 is a precision machine. Please handle this unit with care. Vibration and shock could damage the unit so please use the original packaging if moving the AXIS 262.
- Wait 30 seconds before moving the AXIS 262 after disconnecting the power supply to avoid damaging the hard disk.
- Exposure to water or moisture may cause fire or electrical shock. If water gets inside the unit, disconnect it immediately and contact your dealer.
- Please disconnect the power supply cable if the power supply has been turned off.
- Do not open the cover or touch the internal components.
- Do not use or set the unit where it might be exposed to vibrations or shocks; direct sunlight, rain or snow; flammable or corrosive gas; extreme hot or cold temperatures; humid or dusty conditions; strong electric shock and magnetic fields.
- To extend the lifetime of the unit, keep the operating temperature below 40°C.
- If the temperature is below 0°C, the unit must be turned on at all times.

### Trademark Acknowledgments

Internet Explorer, LAN Manager, Linux, Microsoft, UNIX, Windows, WWW are registered trademarks of the respective holders. Java and all Java-based trademarks and logos are trademarks or registered trademarks of Sun Microsystems, Inc. in the United States and other countries. Axis Communications AB is independent of Sun Microsystems Inc.

### Support Services

Should you require any technical assistance, please contact your Axis reseller. If your questions cannot be answered immediately, your reseller will forward your queries through the appropriate channels to ensure a rapid response. If you are connected to the Internet, you can:

- download user documentation and firmware updates
- report problems to Axis support staff by logging in to your private support area
- visit the Axis Support Web at [www.axis.com/techsup/](http://www.axis.com/techsup/)

### Battery

The AXIS 262 uses a 3.0V CR2032 Lithium battery as the power supply for its internal real-time clock (RTC). Under normal conditions this battery will last for a minimum of 3 years. Low battery power affects the operation of the RTC, causing it to reset to 2003/1/1 at every power-up.

The battery should not be replaced unless required!

If the battery does need replacing, please observe the following:

- Danger of Explosion if battery is incorrectly replaced.
- Replace only with the same or equivalent battery, as recommended by the manufacturer.
- Dispose of used batteries according to the manufacturer's instructions.

AXIS 262 User's Manual  
Revision 1.0, March 2006  
Part No: 25221r2  
Copyright© Axis Communications AB, 2005

# Table of contents

---

|  |    |
|--|----|
| Product Description . . . . .                  | 5  |
| AXIS 262 front panel . . . . .                 | 6  |
| AXIS 262 rear panel . . . . .                  | 7  |
| Accessing the AXIS 262 . . . . .               | 8  |
| Accessing the network video recorder . . . . . | 8  |
| Basic Operation . . . . .                      | 10 |
| Change the password . . . . .                  | 10 |
| Create a new user . . . . .                    | 10 |
| Add a camera . . . . .                         | 11 |
| Configure Main View . . . . .                  | 13 |
| One camera view . . . . .                      | 13 |
| Quad pattern view . . . . .                    | 14 |
| Automatic sequence . . . . .                   | 15 |
| Frame Rates . . . . .                          | 16 |
| Live video . . . . .                           | 16 |
| Recording . . . . .                            | 17 |
| Recording Video . . . . .                      | 18 |
| Scheduled recordings . . . . .                 | 18 |
| Manual recordings . . . . .                    | 23 |
| Play Video . . . . .                           | 24 |
| Playback settings . . . . .                    | 24 |
| Playback using date and time . . . . .         | 25 |
| Playback alarm from list . . . . .             | 26 |
| Save files to PC . . . . .                     | 27 |
| Hard Disk . . . . .                            | 28 |
| Disk utilization . . . . .                     | 28 |
| Replacing the hard disk . . . . .              | 28 |
| System Options . . . . .                       | 30 |
| Date & Time . . . . .                          | 30 |
| Network TCP/IP . . . . .                       | 31 |
| SMTP (email) Settings . . . . .                | 32 |
| Maintenance . . . . .                          | 32 |
| Logs & Reports . . . . .                       | 33 |

|                               |    |
|-------------------------------|----|
| I/O Terminal Connector .....  | 34 |
| Input ports.....              | 34 |
| Output ports .....            | 34 |
| Troubleshooting .....         | 36 |
| Resetting the AXIS 262 .....  | 36 |
| Upgrading the firmware.....   | 37 |
| LED Indicators.....           | 38 |
| NAT traversal.....            | 38 |
| Support .....                 | 39 |
| Technical Specifications..... | 42 |
| Glossary .....                | 44 |

## Product Description

---

The AXIS 262 Network Video Recorder, together with Axis network cameras, offers a comprehensive surveillance solution for detecting shoplifters, reducing false alarms, increasing personnel safety or viewing your premises remotely.

Easy to install and use, the AXIS 262 is a complete recording solution that connects directly to your network and is manageable remotely via a local area network or the Internet. It enables simultaneous recording and remote access to live views and playback of recorded images from up to eight Axis network cameras. Scheduled and triggered recordings can be performed at a recording speed of up to 240 frames per second in QVGA (320x240 pixels) and CIF (352x240 in NTSC, 352x288 in PAL).

The AXIS 262 is ideal for storing video at up to megapixel resolution. There is no degradation in video quality, as it will always give the same image quality as the original image from the camera or video server. A 160 GB hard disk allows you to store, for instance, 10 days of VGA (640x480) resolution at one frame per second from eight video channels.

The main features of the AXIS 262 are:

- Records video from up to eight network cameras at up to megapixel resolution.
- Easy to install, use and manage.
- Enables simultaneous recording and remote access to recorded video, as well as live viewing.
- Records at up to 100 frames per second at VGA (640x480 pixels) or 4CIF (704x480 NTSC, 704x576 PAL).
- Recording can be started by an alarm from a camera or by a trigger from a digital input on the AXIS 262.
- The frame rate for alarm recordings can be specified independently from the frame rate of scheduled recordings. Different video sources can have different frame rates for scheduled recordings.
- 160 GB hard disk with anti-vibration.

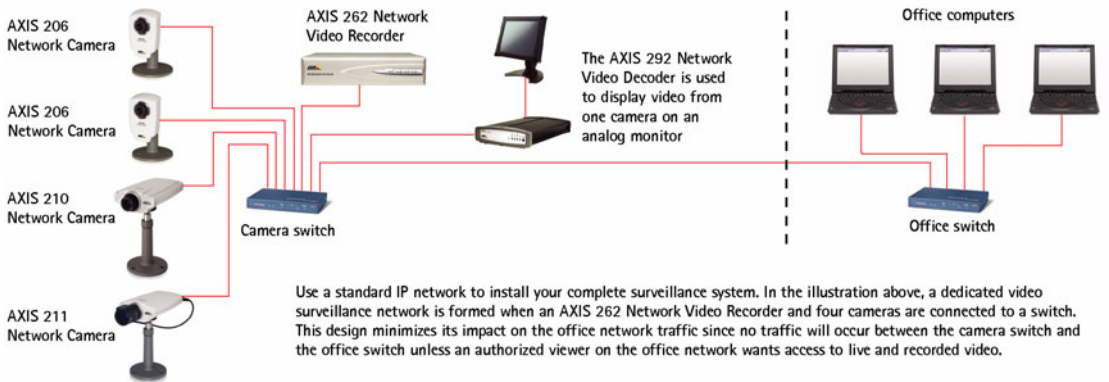

## AXIS 262 front panel

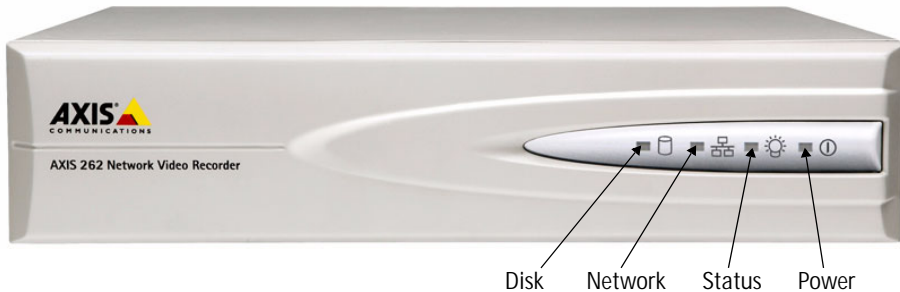

The indicators on the front panel provide useful information about the current status of the AXIS 262. For a complete listing of LED indicator functions, please see *LED Indicators*, on page 38.

## AXIS 262 rear panel

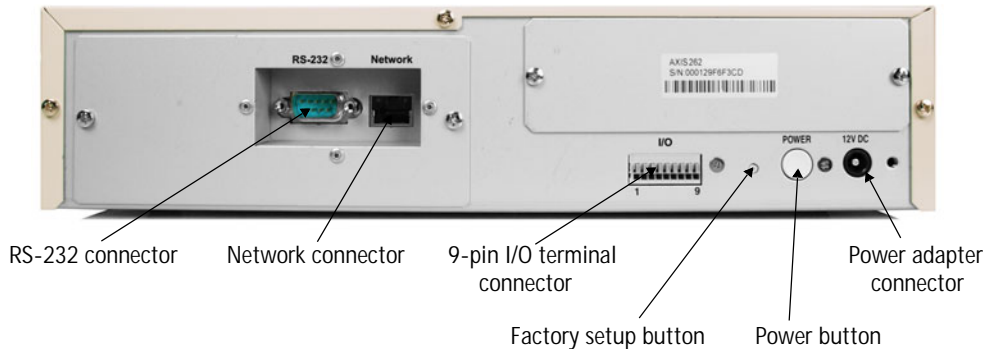

### RS-232 connector

For the connection of a UPS (Uninterruptible Power Supply) unit. The approved UPS model is Smart-UPS from APC.

### Network connector

Connect the AXIS 262 to your network using a standard CAT-5 network cable.

### 9-pin I/O terminal connector

Used to connect external devices, see *I/O Terminal Connector*, on page 34 for more information.

### Factory setup button

Used to reset the AXIS 262 to the factory default settings, see *Resetting the AXIS 262*, on page 36.

### Power button

To shut the AXIS 262 down correctly, press and hold this button until a “beep” sound is heard. Shutdown will then complete after approximately 20 seconds. To start the unit, press the button once.

### Power adapter connector

Connect the power supply cable to the AXIS 262. The AXIS 262 starts up automatically after connecting the power supply cable to a power source.

### Important!

- Never disconnect the power cable when the AXIS 262 is on.
- Use the power button to switch off the AXIS 262.

# Accessing the AXIS 262

## Installation

Before the AXIS 262 can be accessed it must be installed on your network. Please see the Installation Guide supplied with the product. Alternatively, download it from [www.axis.com](http://www.axis.com)

## Accessing the network video recorder

The AXIS 262 supports Microsoft Windows XP Professional SP2 running Internet Explorer 6.0 or later. For more information please see [www.axis.com/techsup](http://www.axis.com/techsup)

1. Start your browser.
2. Enter the IP address of the AXIS 262 in the Location/Address field of your browser.
3. Enter the user name and password set by the administrator (the default user name is *root* and password is *pass*).
4. The Main View page is displayed in your browser.

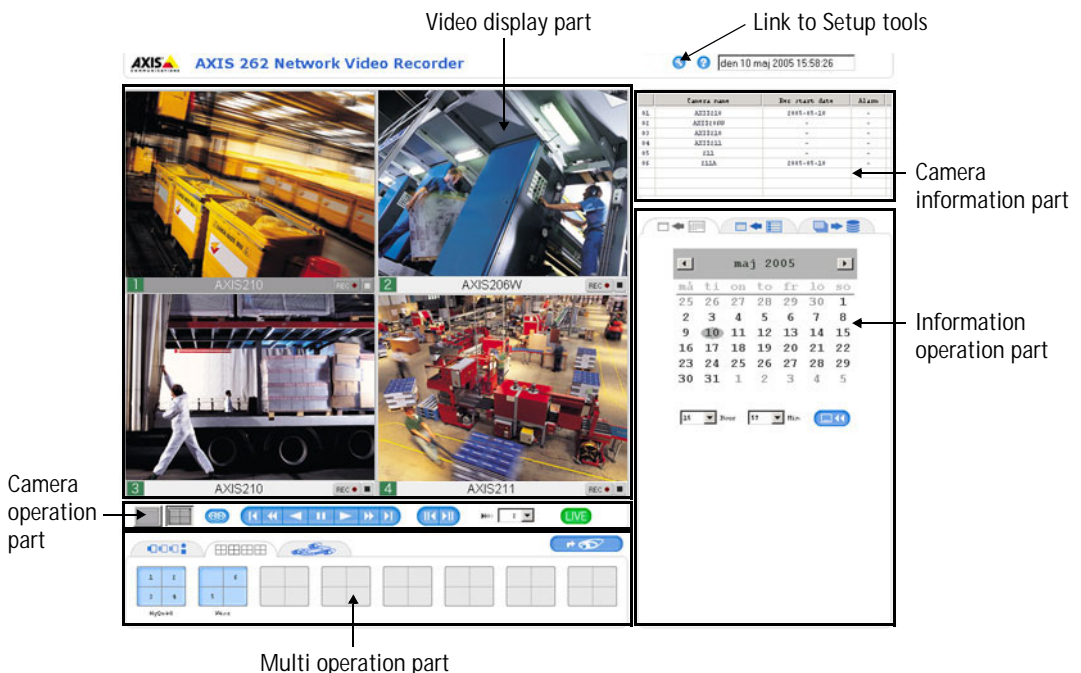



- Notes:**
- To view images from the AXIS 262 in Internet Explorer, you must set your browser to allow ActiveX controls and allow the AXIS 262 Commander to be installed on your computer.
  - The language used in the Main View and the presentation of date and time are dependent on the settings in Windows, e.g. Regional and Language Options in the Control Panel.
  - To access camera specific functions, such as Pan/Tilt/Zoom and audio, you can click on the camera link button  to open the home page of the currently selected camera.

## Basic Operation

---

### Change the password

To prevent unauthorized use, change the default password the first time you log on to the AXIS 262.

**Note:** The default administrator user name root is permanent and cannot be deleted or altered.

1. Click  > Users in the device's Web pages.
2. Enter a password for the user root and then re-enter it to confirm the spelling.
3. Click Save.

### Create a new user

User access control is enabled by default. An administrator can set up other users (maximum 50), by creating new user names and passwords. It is also possible to allow anonymous viewers, which means that anybody may access the Main View page. There are three different groups (levels) of user:

|               |  |
|---------------|--|
| Viewer        | Provides the lowest level of access, which only allows access to the Main View page. In the Main View, a viewer can do everything except record video. |
| Operator      | An operator can view the Main View page and record the video stream. Operators have no access to the Setup pages.                                      |
| Administrator | An administrator has unrestricted access to all the setup tools and can determine the registration of all other users.                                 |

**Note:** It is not possible to create new administrator accounts, there can only be one administrator in the AXIS 262.

To create a new operator or viewer user:

1. Click  > Users in the device's Web pages.
2. Select an unused **User number** from the drop-down list.
3. Enter the user name, using a maximum of 8 characters.
4. Select the user group for the user. See above for the available groups.
5. Enter and confirm the password for the user, using a maximum of 8 characters.
6. Click Save.
7. If you want all users to view the video stream, select the **ON** radio button to enable **Anonymous viewers**. The default setting is **OFF**.
8. Click Save.

**Users**

**User List**

| No | Name | Group         | Note |
|----|------|---------------|------|
| 1  | root | Administrator |      |
| 2  |      |               |      |
| 3  |      |               |      |
| 4  |      |               |      |
| 5  |      |               |      |
| 6  |      |               |      |
| 7  |      |               |      |
| 8  |      |               |      |
| 9  |      |               |      |

User number:

**User Configuration**

User name:

User group:

Password:

Confirm password:

Note:

**User Authentication**

Anonymous viewers and operators:  OFF  ON

a. Select an unused number

b. Enter a user name

c. Select the type of user to create

d. Enter and confirm the password to be used by the user to log on to the AXIS 262

e. Click Save

**Note:** A user can be deleted by selecting a User number from the drop-down list and clicking Remove.

## Add a camera

The AXIS 262 can view, record and playback video from up to eight Axis network cameras simultaneously. When adding or removing a camera, the AXIS 262 stops recording on all cameras for a maximum of 10 minutes. When a camera is added, it may take up to one minute for the live stream to be displayed.

To add a camera:

1. Click  > **Video Sources** in the device's Web pages.
2. Select an unused Camera number from the drop-down list.
3. Enter the camera name, using a maximum of 32 characters. The following characters are not allowed \ / ; : | < > \* ? "
4. Enter the video server port if the camera is connected to a 4-port video server, otherwise leave this as 1.
5. Specify the IP address of the camera or video server.
6. If a user name and password are required to access the device (i.e. anonymous viewer login is not enabled in the device), set the **Authentication** radio button to **ON**.
7. Enter the user ID and password for the device if **Authentication** is enabled.
8. Add comments about the device if desired and click **Save**.



## AXIS 262 Network Video Recorder

Main View | Setup | Help

**Camera Options**  
Video Sources  
Live Streams

**Recording Options**  
Schedule  
Alarm  
Manual  
Disk Utilization

**Layout Options**  
Quad Patterns

**System Options**  
Users  
Date & Time  
Network TCP/IP  
SMTP(email)  
Maintenance  
Support Overview  
Logs & Reports  
Advanced Overwrite

**About**

### Video Sources ?

**Video Source List**

| No | Name       | IP address    | Port | Alarm |
|----|------------|---------------|------|-------|
| 1  | Basement   | 10.92.132.207 | 1    | ON    |
| 2  | Front door | 10.92.132.211 | 1    | ON    |
| 3  | Entrance   | 10.92.132.6   | quad |       |
| 4  |            |               |      |       |
| 5  |            |               |      |       |
| 6  |            |               |      |       |
| 7  |            |               |      |       |
| 8  |            |               |      |       |

Camera number: 1:Basement

**Camera Configuration**

Name:

Video server port: 1

IP address:

Authentication:  OFF  ON

User ID:

Password:

Note:

**Note:**  
When using these buttons, the unit will stop recording on all cameras for a maximum of 10 minutes.  
When a camera is removed, the recorded video from that camera will also be deleted.

**Alarm Recording**

Alarm recording:  OFF  ON

Triggered by: Local input port

**Note:**  
When using these buttons, the unit will stop recording on all cameras for a maximum of 10 minutes.  
If alarm recording is ON and is then set to OFF, the recorded video from the alarm recording for that camera will be deleted.

- Notes:**
- To remove a registered camera, select it in the Camera number drop-down list and click the Remove button. To save recorded data, download it to a PC before removing the camera, see *Save files to PC*, on page 27.
  - The cameras added must be accessible on port 80 if the AXIS 262 shall be able to connect to the camera.
  - The AXIS 262 cannot connect to cameras located on the other side of a proxy server.

### Important!

When a camera is removed, the recorded data from that camera will also be deleted.

# Configure Main View

In the Main View you can watch live or recorded video from one camera in a large window or from four cameras in the quad view. When you double-click on a camera view, the display is shown in full-screen mode. Double-clicking a second time returns the display to normal mode.

You can right-click in the camera view in full-screen and normal mode to open up a context sensitive menu with different options. The title bar of the currently selected camera is shown in gray.

One camera view

Quad pattern view

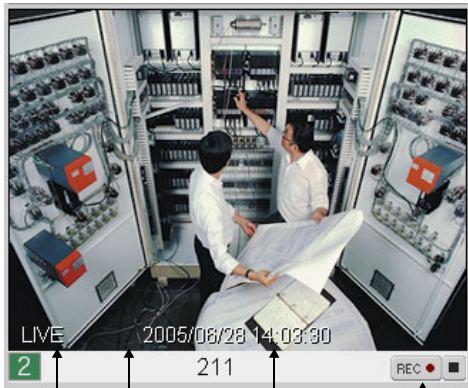

Image state    Video    Video time    Manual recording start/stop



Camera number    Camera name

## One camera view

### Camera selection

Once you have added cameras, you can view them in the Main View. Select the Single display button and then select the camera you want to view.

a. Click single display



b. Select a camera to view



## Quad pattern view

View live or recorded video from four cameras using the quad pattern view.

Create a new quad pattern

1. Click  > Quad Patterns in the device's Web pages.
2. Select an unused Pattern number from the drop-down list.
3. Give the pattern a name.
4. Select the camera to be shown in each position, or select OFF to leave a position blank.
5. Set the Display to ON to make the pattern visible in the Main View.
6. Click Save.

**Note:** To remove a pattern, select it in the Pattern number drop-down list and click the Remove button.

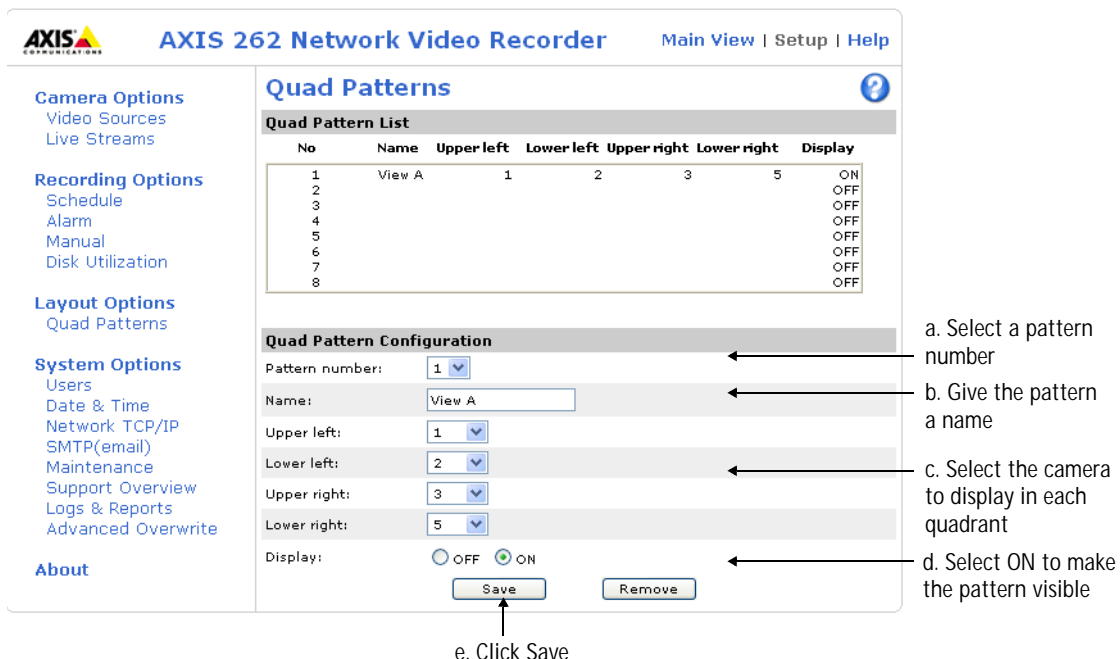

**AXIS 262 Network Video Recorder** Main View | Setup | Help

**Camera Options**  
Video Sources  
Live Streams

**Recording Options**  
Schedule  
Alarm  
Manual  
Disk Utilization

**Layout Options**  
Quad Patterns

**System Options**  
Users  
Date & Time  
Network TCP/IP  
SMTP(email)  
Maintenance  
Support Overview  
Logs & Reports  
Advanced Overwrite

**About**

### Quad Patterns

**Quad Pattern List**

| No | Name   | Upper left | Lower left | Upper right | Lower right | Display |
|----|--------|------------|------------|-------------|-------------|---------|
| 1  | View A | 1          | 2          | 3           | 5           | ON      |
| 2  |        |            |            |             |             | OFF     |
| 3  |        |            |            |             |             | OFF     |
| 4  |        |            |            |             |             | OFF     |
| 5  |        |            |            |             |             | OFF     |
| 6  |        |            |            |             |             | OFF     |
| 7  |        |            |            |             |             | OFF     |
| 8  |        |            |            |             |             | OFF     |

**Quad Pattern Configuration**

Pattern number:

Name:

Upper left:

Lower left:

Upper right:

Lower right:

Display:  OFF  ON

a. Select a pattern number

b. Give the pattern a name

c. Select the camera to display in each quadrant

d. Select ON to make the pattern visible

e. Click Save

### View quad patterns

Once a quad pattern has been created, it can then be viewed in the Main View page. You can also select which quad pattern you want to view. Select the quad pattern view and then select the pattern you want to view from the quad pattern tab.

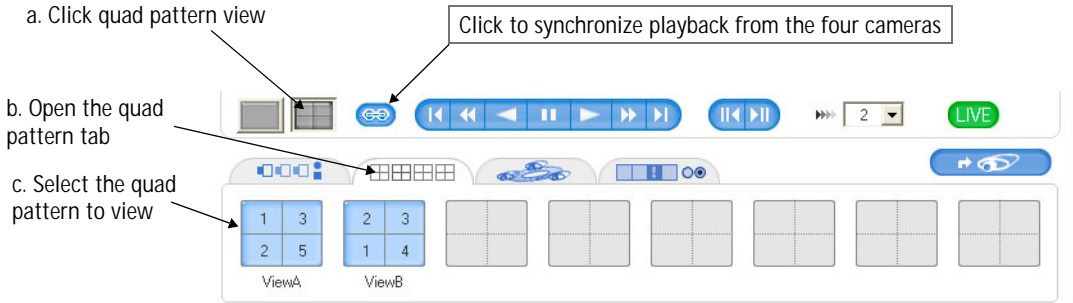

**Note:** You can select to watch video from the four cameras at the same point in time by selecting the Synchronize button.

### Automatic sequence

A sequence will automatically switch between cameras or between quad patterns in the Main View.

1. Open the automatic sequence tab.
2. Select the cameras or quad patterns to include in the sequence.
3. Click to start the camera or quad view sequence.
4. Click the stop button to stop the sequence.

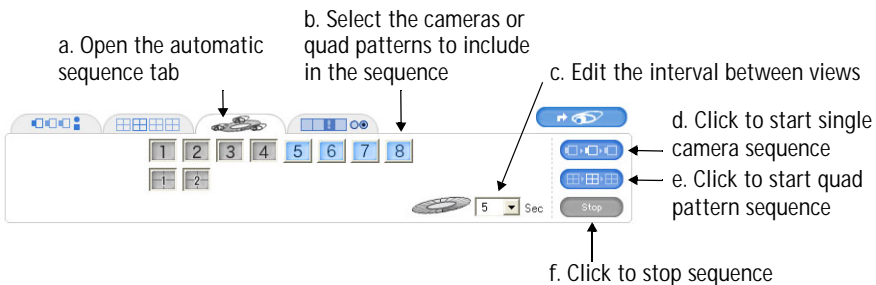

**Note:** You must select at least two cameras/quad patterns to start a sequence.

## Frame Rates

The default frame rate for viewing live video streams and recorded video in the Main View is 30 frames per second. You can select from a range of frame rates, i.e. from 30 frames per second to one frame every minute.

### Live video

The frame rate of the live video shown in the Main View can be edited as follows:

1. Click  > Live Streams in the device's Web pages.
2. Select the camera to configure from the Camera number drop-down list.
3. Select the number of frames to record per second from the Live view frame rate drop-down list.
4. Click Save.

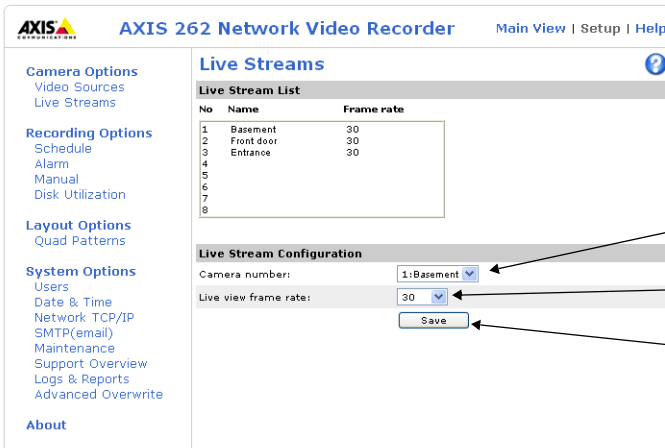

**AXIS** **AXIS 262 Network Video Recorder** [Main View](#) | [Setup](#) | [Help](#)

**Camera Options**  
[Video Sources](#)  
[Live Streams](#)

**Recording Options**  
[Schedule](#)  
[Alarm](#)  
[Manual](#)  
[Disk Utilization](#)

**Layout Options**  
[Quad Patterns](#)

**System Options**  
[Users](#)  
[Date & Time](#)  
[Network TCP/IP](#)  
[SMTP\(email\)](#)  
[Maintenance](#)  
[Support Overview](#)  
[Logs & Reports](#)  
[Advanced Overwrite](#)

**About**

### Live Streams

**Live Stream List**

| No | Name       | Frame rate |
|----|------------|------------|
| 1  | Basement   | 30         |
| 2  | Front door | 30         |
| 3  | Entrance   | 30         |
| 4  |            |            |
| 5  |            |            |
| 6  |            |            |
| 7  |            |            |
| 8  |            |            |

**Live Stream Configuration**

Camera number:

Live view frame rate:

a. Select the camera to configure

b. Select how many frames per second to view live video streams at

b. Click Save



## Recording

Although the AXIS 262 records images at the highest frame rate the network camera or video server can deliver, this might actually be lower than the value set in the Frame rate option. This can happen if there is only limited bandwidth available, or if the camera/video server is limiting the frame rate.

If the frame rates for manual and scheduled recording are different, the AXIS 262 records data at the frame rate set for the camera in the manual recording. Alarm recordings always use the frame rates specified when configuring an alarm recording.

### Set manual recording frame rate

To change the frame rate for manual recording:

1. Click  > **Manual** in the device's Web pages.
2. Select the camera to configure from the Camera number drop-down list.
3. Select the number of frames to record per second from the Manual recording frame rate drop-down list.
4. Click Save.

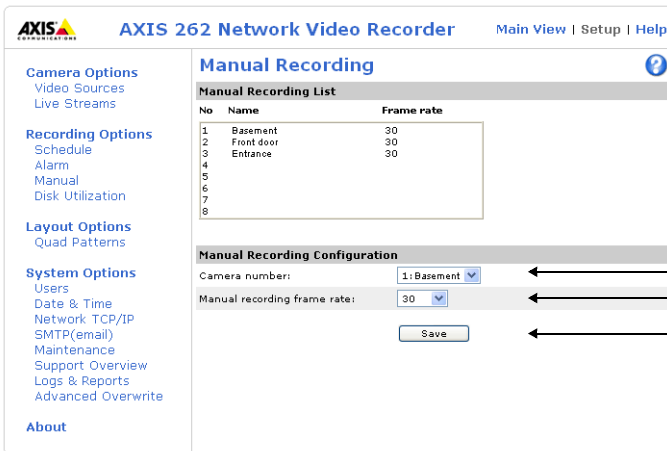

**AXIS 262 Network Video Recorder** Main View | Setup | Help

**Manual Recording**

**Manual Recording List**

| No | Name       | Frame rate |
|----|------------|------------|
| 1  | Basement   | 30         |
| 2  | Front door | 30         |
| 3  | Entrance   | 30         |
| 4  |            |            |
| 5  |            |            |
| 6  |            |            |
| 7  |            |            |
| 8  |            |            |

**Manual Recording Configuration**

Camera number:  ← a. Select the camera to configure

Manual recording frame rate:  ← b. Select frame rate

← b. Click Save

- a. Select the camera to configure
- b. Select frame rate
- b. Click Save

## Recording Video

Recording video to the AXIS 262's hard disk can be scheduled to take place at certain times, triggered by an alarm or started manually. For example, if a camera is used to monitor a workplace, you may want to record video Monday to Friday during work hours, and also have recordings triggered from an incoming signal from an input, when e.g. a door is opened or motion is detected. You can also start and stop the recording on any of the cameras manually from the Main View.

The camera selection tab shows if video from the camera is being recorded and what triggered the recording.

- Camera 1: Scheduled recording in progress
- Camera 2: Alarm recording in progress
- Camera 3: Manual recording in progress
- Camera 4: Not recording



### Scheduled recordings

You can configure the times and days when recordings will occur each week. Recordings can be scheduled to start and stop multiple times on any particular day, e.g. every Tuesday between 10:00-12:45, 14:00-16:15 and 20:30-23:00. Each day of the week can have different schedules or the same time periods can be set for multiple days simultaneously.

#### Schedule a recording

1. Click  > Schedule in the device's Web pages.
2. Select the camera to configure from the Camera number drop-down list.
3. Select the day(s) and then set the start time, end time and frame rate.
4. Click Save and repeat for additional schedules.

a. Select the camera to configure

Scheduled recordings  
e.g. Tue 09:00 - 17:00

b. Select day(s) to schedule recordings

c. Select times to start and stop recordings

d. Select frame rate

e. Click Save

### Delete scheduled recordings

1. Select the camera which has a scheduled recording that you wish to delete, from the Camera number drop-down list.
2. Click the time period to delete in the Weekly Schedule Overview and click the Delete button.
3. Delete all the schedules in a day by selecting the day(s), then selecting the All day setting and clicking Delete.

**Note:** Scheduled recordings can be turned off temporarily on all cameras by selecting the OFF radio button and clicking Save. All camera schedules are saved for future use.

## Alarm recordings

Alarm recording is triggered by a signal from an input port on the AXIS 262, or when an alarm notification from a network camera or video server triggers recording.

To configure a camera for alarm recording:

1. Click  > **Video Sources** in the device's Web pages.
2. Select the camera to configure from the Camera number drop-down list.
3. Set the Alarm recording radio button to ON.
4. Select if alarms are triggered by local input ports or by the camera.
5. Click Save.

**AXIS 262 Network Video Recorder** Main View | Setup | Help

**Video Sources**

**Video Source List**

| No | Name       | IP address    | Port | Alarm |
|----|------------|---------------|------|-------|
| 1  | Basement   | 10.92.132.207 | 1    | ON    |
| 2  | Front door | 10.92.132.211 | 1    | ON    |
| 3  | Entrance   | 10.92.132.6   | quad | ON    |
| 4  |            |               |      |       |
| 5  |            |               |      |       |
| 6  |            |               |      |       |
| 7  |            |               |      |       |
| 8  |            |               |      |       |

Camera number:

**Camera Configuration**

Name:

Video server port:

IP address:

Authentication:  OFF  ON

User ID:

Password:

Note:

**Alarm Recording**

Alarm recording:  OFF  ON

Triggered by:

**Notes:**  
When using these buttons, the unit will stop recording on all cameras for a maximum of 10 minutes.  
When a camera is removed, the recorded video from that camera will also be deleted.

**Notes:**  
When using these buttons, the unit will stop recording on all cameras for a maximum of 10 minutes.  
If alarm recording is ON and is then set to OFF, the recorded video from the alarm recording for that camera will be deleted.

a. Select the camera to configure

b. Enable alarm recording for this camera

c. Select trigger

d. Click Save

6. Next, open the Alarm Recordings page by clicking on the Alarm link in the devices web pages.
7. Select the camera to configure from the Camera number drop-down list.
8. Select the frame rate for either input port or camera depending on how alarms are triggered (see step 4 above).
9. If alarms are triggered by the camera, select the maximum duration for a recording in Max recording time.

10. If you want to receive TCP messages when alarm recordings start and stop, enter the messages.
11. Click Save.
12. If you want to receive TCP messages you also need configure the TCP server. Note that TCP messaging is optional.
13. Click Save to save the settings.

Camera 1 triggered by local input port

**Alarm Recording List**

| No | Name       | Frame rate (Local) | Frame rate (Camera) | Rec. time | TCP notice |
|----|------------|--------------------|---------------------|-----------|------------|
| 1  | Basement   | 30                 |                     |           | ON         |
| 2  | Front door |                    | 30                  | 1m        | OFF        |
| 3  | Entrance   |                    |                     |           | OFF        |
| 4  |            |                    |                     |           | OFF        |
| 5  |            |                    |                     |           | OFF        |
| 6  |            |                    |                     |           | OFF        |
| 7  |            |                    |                     |           | OFF        |
| 8  |            |                    |                     |           | OFF        |

**Alarm Recording Configuration**

Camera number:

Triggered by input port:    
 Frame rate:

Triggered by camera:    
 Frame rate:    
 Max recording time:  Seconds

TCP notification:  OFF  ON   
 Message when recording starts:    
 Message when recording stops:

**TCP Notification Configuration**

TCP notification:  OFF  ON   
 Primary server:   
 IP address/host name:    
 TCP port:    
 Secondary server:   
 IP address/host name:    
 TCP port:

e. Select the camera to configure

f. Select frame rate for recorded video

g. Enable TCP notification messages\*

h. Enter TCP message text\*

i. Click Save

j. Enable TCP notification messages\*

k. Configure TCP server\*

l. Click Save\*

\* Optional - for TCP message notification

### Camera triggering alarms

If you have selected to trigger alarm recordings using the camera rather than the local input ports, the camera (or video server) needs to be configured to send a notification message to the AXIS 262.

To set up notification on any Axis device that supports HTTP notification:

1. Open the **Event Servers** page in the Axis camera/video server.
2. Add an HTTP server with the following details:
  - Use **AXIS 262** as the event server name.
  - Enter `http://<IP-address>/axis-cgi/operator/record/record.cgi` as the URL. <IP-address> should be replaced with the IP address or host name for the AXIS 262.
  - Specify a user name already registered in the AXIS 262. This can be an operator or an administrator.
  - Password: Specify the password for the above user.
3. The next step is to configure an event type that will send a notification to the event server (the AXIS 262). Open the **Event Types** page in the Axis camera/video server.
4. To add a triggered event, click **Add triggered ...**
5. The **General** and **Respond to trigger...** settings do not need to be edited.
6. Select the circumstances that start the event in the **Triggered by...** drop-down list.
7. Check the box for **Send HTTP notification**, and select the Event Server as configured above.
8. If the trigger is for when the alarm starts, enter `action=start&trigger=alarm&sourceno=videosourceno` in the **Custom parameters** field. "videosourceno" is the camera number (1 to 8).
9. If the trigger is for when the alarm stops, enter `action=stop&trigger=alarm&sourceno=videosourceno` in the **Custom parameters** field. "videosourceno" is the camera number (1 to 8).
10. Click **OK**.

## Manual recordings

Recording can be started manually for any of the cameras in the Main View or for all cameras. Each camera view has buttons at the bottom right of the window to start and stop recording. In the Select camera tab there are buttons to start and stop recording on all cameras.



## Play Video

Video from manual, scheduled and alarm recordings can be played back in the Main View. You can even play back recorded video while recording is ongoing. Go to a specific date and time and play video from one or four cameras, or use the alarm list to select and view alarm recordings. Recordings from scheduled, manual and alarm recordings can also be saved as AVI files on your computer.

The camera operation tools below the viewer screen provide the following features when playing back video:

- Play video forwards and backwards at various speeds
- Jump to the start and end of the recordings for any camera
- Synchronize playback to see what happened on four cameras at a certain point in time
- Pause recordings and move forward or back one image at a time

### Playback settings

When you playback a recording, you can select from the following options:

- Only view manual and scheduled recordings
- View all recordings, i.e. manual, scheduled and alarm recording
- Only view alarm recordings

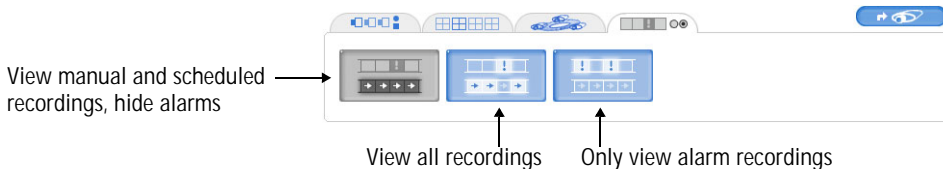

**Note:** When you select the option to view all recordings and there exists both alarm and manual/scheduled recordings, the recording played back will be the one with the highest frame rate.



## Playback using date and time

You can open a recording for a camera at a certain date and time and playback recordings from one or four cameras simultaneously. To playback a recording from a certain date and time:

1. Select the camera(s) to view.
2. Select the date and time to start playback from.
3. Click the Go to button to open the video at the specified time. The video will open at the next available image if there is no recording at the specified date and time.
4. Use the controls to start playback or to fast forward through the video.

**Note:** The playback settings will determine what type of recordings are played back, e.g you might select to only view alarm recordings.

The screenshot displays the playback interface for the AXIS 262 camera. It includes a main video window showing a scene with two people in a control room. Below the video is a playback control bar with buttons for stop, play, and fast forward. To the right, there is a table of alarm information and a calendar for June 2005. Arrows point to various UI elements with labels 'a' through 'f'. A callout box on the left explains the orange square in the video feed, and another on the top right explains the table header.

Information on alarms for each camera

| Camera name   | Rec starting date | Alarm |
|---------------|-------------------|-------|
| 01 Basement   | 2005-06-11        | New   |
| 02 Front room | 2005-06-13        | -     |
| 03 Entrance   | 2005-06-13        | -     |
| 04 Gate       | -                 | -     |

Orange square indicates that an alarm recording is being played

a. Select a camera

b. Select month

c. Select date

d. Select the time

e. Open recording at this time

f. Play recorded video

## Playback alarm from list

The alarms recordings for each camera are presented in a list and you can select an alarm from the list and play it. Each alarm listing includes the date and time the recording began and ended, a thumbnail image taken at the start of the recording and the number of the recording.

The camera information part shown in the top right of the Main View provides additional information on the alarm list. If there are alarms for a camera, the **Alarm** column will show **Yes**, if there are alarms that have not yet been viewed for a camera, the **Alarm** column will show **New**.

To open an alarm recording:

1. Open the Alarm list tab.
2. Select the camera(s) to view from the drop-down list.
3. Click once on an alarm from the list.
4. Click the Go to button.
5. The alarm recording will now open in the viewer screen.

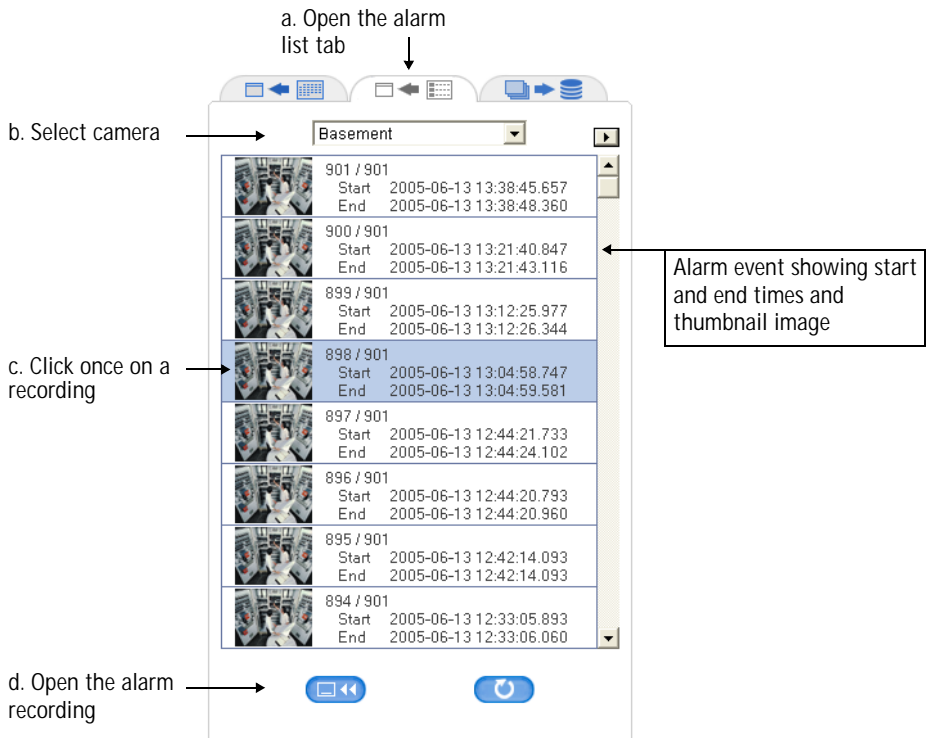

## Save files to PC

Recordings from alarm and manual/scheduled recordings can be saved to your computer's hard drive as AVI files. You need to select where to start and end the recording and where you want to save it. It is not possible to save combined alarm and manual/scheduled recordings.

To save part of a recording as an AVI file:

1. Select either alarm or manual/scheduled recordings in the playback settings.
2. Select a camera.
3. Select the **Download** tab.
4. Move to where you want the recording to start using the time search and the playback controls.
5. When at the point in the recording where you want to start, click the **Set** button in the **START** panel.
6. Move to where you want to end and click the **Set** button in the **STOP** panel.
7. Specify the folder on your computer to download to.
8. Click the download button to start saving the recording to your computer.

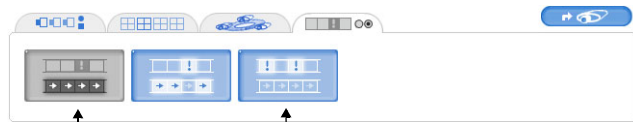

a. Select either manual/scheduled recordings or alarm recordings



b. Select a camera

| Camera name   | Rec. starting date | Alarm |
|---------------|--------------------|-------|
| 01 Basement   | 2005-05-12         | New   |
| 02 Front room | 2005-06-13         | -     |
| 03 Entrance   | 2005-06-13         | -     |
| 04 Date       |                    |       |



- c. Specify date and time to go to in a recording
- d. Open recording at this date and time
- e. Click to set this as start point
- f. Move to where the recording should end and click Set
- g. Select where to save AVI file
- h. Edit file name if desired
- i. Start saving the AVI file to your computer

## Hard Disk

---

### Disk utilization

This page shows the current disk utilization and allows you to set the disk space allotted to each camera for manual/scheduled recording and alarm recording. A new camera is, by default, allotted 12 GB of disk space for manual and scheduled recordings and is allotted 7 GB of disk space for alarm recordings.

Click  > **Disk Utilization** in the device's Web pages to view and edit how much disk space is allotted to each camera and to view how much free disk space is left.

**Note:** Recordings may be erased if you reduce the disk capacity allotted to a camera.

### Overwriting data

When the recorded data reaches its storage limit, you can configure whether older recorded data is overwritten or not. Click  > **Advanced Overwrite**, select the number of the camera to configure, and then select the **ON** or **OFF** radio button for each recording mode.

**Note:** If set to OFF the hard disk can become full and it will not be possible to record any more data for that camera.

### Replacing the hard disk

If the hard disk in the AXIS 262 fails, it can be replaced. A hard disk up to 400 GB can be used, but the recommended size is 160 GB.

Note that for the product warranty to be valid:

- a) the disk must be replaced with the 160 GB replacement disk supplied by Axis (part number 5002-011 ACC HARDDISK 160GB AXIS 262)
- b) the disk must only be replaced by personnel authorized to do so by Axis.

Axis does not guarantee functionality with any other hard disk than the one originally included, or its authorized replacement.

**Note:** If a disk larger than 160 GB is used, the maximum number of users will be decreased

#### Caution!

The electronics of the AXIS 262 can be sensitive to Electrostatic Discharges (ESD). Be sure to take proper precautions when replacing the hard disk, e.g. ground straps, gloves or ESD mats.

Make sure the power cable is disconnected before removing the cover to avoid electrical hazards.

To replace the hard disk:

1. Disconnect the power cable.
2. Unscrew the cover screws (two on each side and three on the back, see *AXIS 262 rear panel*, on page 7) of the AXIS 262.
3. Remove the cover.
4. Disconnect the hard disk's IDE and power cables.
5. Unscrew the two screws that fix the hard disk bracket to the AXIS 262.
6. Remove the bracket, and loosen the screws that connect the hard disk to the bracket.
7. Insert a new hard drive into the bracket and screw the bracket to the base of the AXIS 262 again.
8. Attach the power and IDE cables, replace the cover and reconnect the power cable.

**Note:** Ensure that the jumper settings on the new hard disk are set to master.

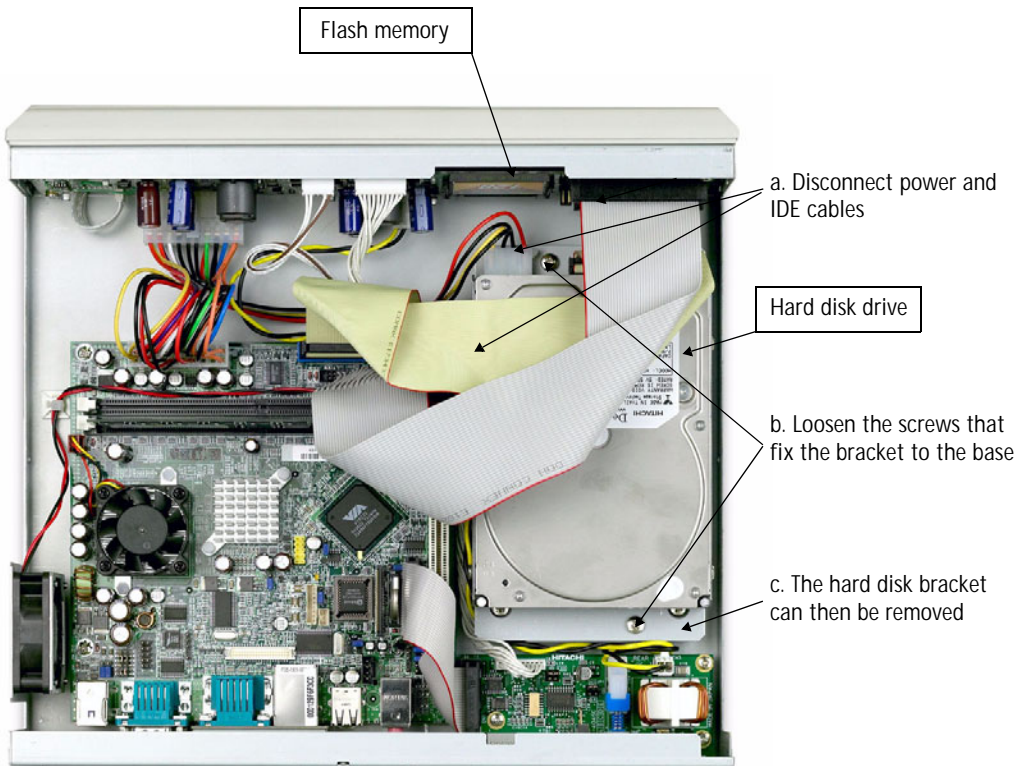

## System Options

---

There are different system options that can be configured in the **Setup** pages, e.g. date & time, network settings and upgrading the firmware in the AXIS 262. This section describes the options not covered elsewhere in this manual.

### Date & Time

The date and time is displayed when viewing recorded or live video (right-click on an image and select **Show Date/Time** to make it visible if it is not shown). The time and date are saved along with the image and it is important that the date and time are set accurately when you want to find a recording at a later time.

You can manually set the date and time used for the AXIS 262 or specify a Network Time Protocol (NTP) server to automatically update the time. You can also enter the time zone and the date format displayed on recorded images.

**Note:** Changing the time zone will cause the AXIS 262 to restart, and recording will be stopped during this time (maximum 10 minutes).

To set the time in the AXIS 262:

1. Click  > **Date & Time** in the device's Web pages.
2. Select the **Set manually** radio button if you want the time to be updated manually or select the **Synchronize with NTP server** radio button to synchronize the time automatically with an NTP server.
3. Enter the current date and time if the time is updated manually.
4. If using automatic update, enter the IP address of the NTP server and how often to synchronize the time with the NTP server.
5. Click **Save**.
6. Select the time zone you are in. When there is more than one option available select the list item with cities that have similar daylight savings. The time will automatically adjust for daylight savings and correct the time difference when using an NTP server.
7. Click **Save**.

a. Select manual or automatic time updates

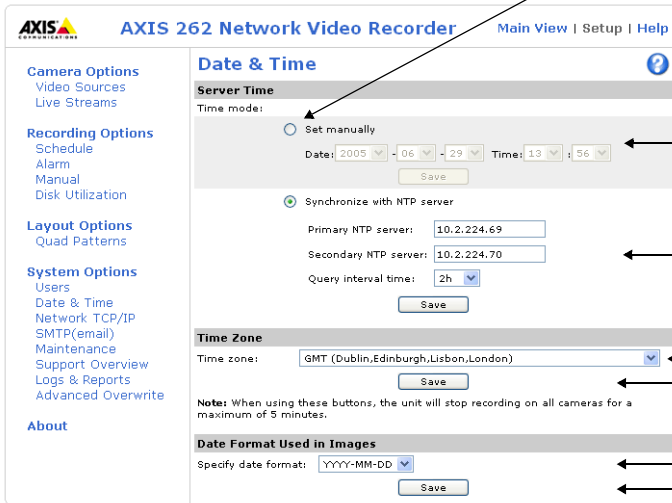

b. To set time manually:

- enter the date and time
- click Save

c. For automatic time updates:

- enter the IP address of the NTP server
- enter time between queries
- click Save

d. Select time zone

e. Click Save

f. Select date format

g. Click Save

## NTP server

An important feature of the AXIS 262 is that it can be used by any of the network cameras or video servers as an NTP server. Open the configuration pages for the network camera or video server and enter the IP address of the AXIS 262 as the NTP server. This will ensure that the date and time in the network cameras and video servers is synchronized with the AXIS 262.

**Note:** The time displayed in the Main View is the current time on your PC and not the time set in the Date & Time settings.

## Network TCP/IP

The IP address of the AXIS 262 and other network settings are configured during installation, but they can be edited on the Network TCP/IP page if they are lost or need to be changed. The AXIS 262 supports dynamic and static IP addresses.

To allow the AXIS 262 to use host names, you must provide the IP address of at least one (the primary) DNS server.

To access NTP and/or SMTP servers by host names, please note that these need to be configured in the DNS server(s) on your network.

## SMTP (email) Settings

The AXIS 262 can send email to up to five preconfigured email addresses when a hard disk error or system error occurs. To add an email address to the list:

1. Click  > SMTP(email) in the device's Web pages.
2. Select an unused Number from the drop-down list.
3. Enter the email address in the Send email to field.
4. Click Save.

The settings on SMTP (email) Settings page enable and configure mail addresses, servers, etc.

1. Click  > SMTP (email) Settings in the device's Web pages.
2. Set the SMTP notification to ON.
3. Specify the email address shown as the sender of the email.
4. Enter the IP address or host name of the SMTP server to use for sending mail. You can have primary and secondary SMTP servers.
5. If the SMTP server requires POP3 authentication before the AXIS 262 is allowed to send mail, set POP3 Authentication to ON. The default setting is OFF.
6. If necessary, enter the IP address or host name of the POP3 server, the user name and the password.
7. Click Save.

## Maintenance

The Maintenance page contains tools for maintaining, upgrading and backing up the configuration of the AXIS 262. Click  > Maintenance in the device's Web pages to open the Maintenance page. The following options are available:

- **Restart:** You can restart the AXIS 262 if you are experiencing problems.
- **Restore:** Resets all parameters, except the IP parameters, to the original factory settings.
- **Default:** Resets all parameters to the original settings.
- **Upgrade:** Install new firmware in the AXIS 262.
- **Backup:** Save all parameters to a backup file.
- **Restore:** Use a saved backup file to return the unit to a previous configuration.



## Logs & Reports

When troubleshooting the AXIS 262, you can view the log file, the server report showing the status of the device, and a list of all the parameter settings. The log file is stored on the hard disk and is only erased when you press the factory setup button. The **Logs & Reports** page also allows you to save all parameters to a backup file.

To view the log file, server report and parameter list:

1. Click  > **Maintenance** in the device's Web pages.
2. Click **Logs**, **Server Report** or **Parameter List** to open up the file in a separate window.

## I/O Terminal Connector

The 9-pin I/O terminal connector provides the interface to four digital outputs, four digital photo-coupled inputs and GND.

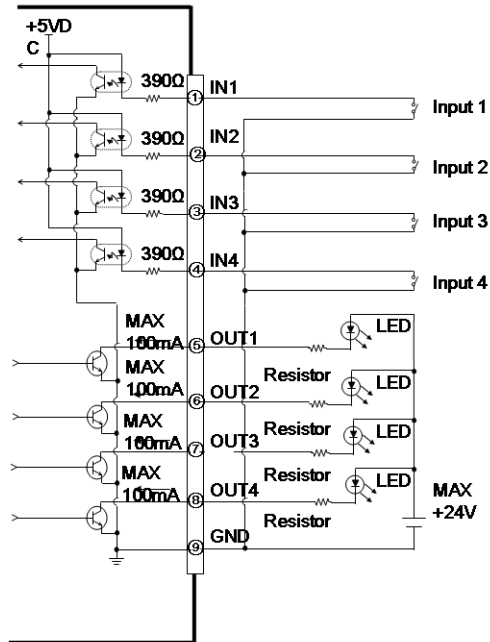

### Input ports

The input ports are on pins 1-4. They are used for connecting external alarm devices to trigger alarm recordings. The input is typically connected to a motion detector or any other external security device. When you specify an input port as an alarm trigger, this number corresponds to the camera number. When AXIS 262 detects ON (input pin is connected to GND pin), recording is started and is stopped when OFF (input pin is left floating or connected to +5V DC or higher) is detected. Maximum 5V DC is allowed on the input

### Output ports

The output ports are on pins 5-8. They can drive a maximum load of 24V DC at 100mA directly or heavier loads by connecting additional relay circuitry. If the output is used with an external relay, a diode must be connected in parallel with the load, for protection against any voltage transients.

Table 1: Terminal Connector Pinout

| Pin | Signal       |
|-----|--------------|
| 1   | Alarm input1 |
| 2   | Alarm input2 |
| 3   | Alarm input3 |
| 4   | Alarm input4 |
| 5   | Output 1     |
| 6   | Output 2     |
| 7   | Output 3     |
| 8   | Output 4     |
| 9   | GND          |

Table 2: Output Port

|      | Event                   | Function  | State |
|------|-------------------------|---|-------|
| Out1 | Alarm recording starts  | If any of the sources start or stop alarm recording, it outputs the status. | ON    |
|      | Alarm recording stops   |   | OFF   |
| Out2 | Camera lost starts      | If any of the sources lost its connection, it outputs the status.           | ON    |
|      | Camera lost stops       |   | OFF   |
| Out3 | Hard disk error         | If a hard disk error occurs, it outputs the status.                         | ON    |
| Out4 | Hard disk full          | If the hard disk is full, it outputs the status.                            | ON    |
|      | Space left on hard disk |   | OFF   |

## Troubleshooting

---

To solve a problem with the AXIS 262, consult the list of symptoms and corrective actions, or see the information on upgrading the firmware.

### Resetting the AXIS 262

If you are experiencing a problem with the AXIS 262, there are a few options available to correct the problem. The first option to try would be to restart the unit. Resetting the AXIS 262 to the factory default settings should only be used if all other options fail. The Restart, Restore and Default options can be accessed by clicking  > Maintenance. There is a button on the rear of the AXIS 262 for restoring the factory default settings.

#### Restart

The Restart button on the Maintenance page will restart the AXIS 262, no settings will be lost as a result.

#### Restore

If the unit does not behave as expected, use the Restore button on the Maintenance page to reset all parameters, except the IP parameters, to their original factory settings.

#### Default

The Default button on the Maintenance page is similar to Restore. The only difference is that the IP parameters are also reset to their original settings.

#### Factory default settings

This option resets all parameters, including the IP address, to the factory settings. Resetting the device to factory settings may be used if you cannot contact the AXIS 262, have installed a new hard disk, or if the hard disk LED is red and a restart does not help.

**Note:** The recordings on the hard disk will be erased when you use Restore and Default, or set the AXIS 262 to factory default settings.

To reset the device to the factory default settings:

1. Press and hold the Factory setup button (rear panel) until the Status Indicator flashes amber (which may take up to 15 seconds), then release the button.
2. When the Status Indicator displays green (which can take up to 1 minute) the camera is reset to the factory default settings.
3. Re-install the AXIS 262 using one of the methods described in the Installation Guide.

## Upgrading the firmware

Firmware is software that determines the functionality of the AXIS 262. One of your first actions when troubleshooting a problem should be to check the currently installed version. The latest version may contain a correction that fixes your particular problem. The current firmware version in your AXIS 262 is shown in the server report, see  > **Logs & Reports**.

When you download firmware from the Axis Web site, the AXIS 262 will receive the latest available functionality. Always read the upgrade instructions and release notes available with each new release, before updating the firmware. New firmware can be downloaded to the AXIS 262 over the network.

**Note:** All recorded data and configuration except network settings are erased when upgrading the firmware.

1. Save the firmware file to your computer. The latest version of the AXIS 262 firmware is available free of charge from the Axis Web site at [www.axis.com/techsup](http://www.axis.com/techsup) or from your local distributor.
2. Go to  > **Maintenance** in the video server's Web pages.
3. In the **Upgrade Server** section, browse to and select the desired firmware file.
4. Click **Upgrade**.

**Notes:**

- Always read the upgrade instructions available with each new release, before updating the firmware.
- If you suspect that the procedure has failed, you should wait at least 20 minutes before restarting the AXIS 262.
- Your dealer reserves the right to charge for any repair attributable to faulty updating by the user.

## LED Indicators

The LED indicators on the AXIS 262 indicate the following:

|         |       |  |
|---------|-------|--|
| Disk    | Green | Flashes when the hard disk is accessed.  |
|         | Red   | Shows steady for failed reset to factory default, failed firmware upgrade, failed database repair, or for a hard disk error.<br><br>To save recorded video stored on the hard disk drive, download the video to your PC and then restart the AXIS 262 to return the hard disk to its normal state. |
| Network | Amber | Flashes for activity on a 10 Mbps network.   |
|         | Green | Flashes for activity on a 100 Mbps network.  |
|         | None  | No connection.   |
| Status  | Green | Shows steady green for normal operation.   |
|         | Amber | Flashes during a reset to the factory default settings.  |
|         | Red   | Flashes red in combination with red disk LED for failed reset to factory default, failed firmware upgrade, or failed database repair. Flashes red without red disk LED to indicate that the database is being repaired, which may take up to 30 minutes.   |
| Power   | Green | Normal operation.  |
|         | Amber | Flashes green/amber during a firmware upgrade.   |

**Note:** Note that the indicator LEDs are tested during startup. The Status, Network and Disk LEDs show red for 1 second, and the Power LED shows amber for 1 second.

## NAT traversal

Depending on your network configuration, it may be necessary to use NAT traversal to access the AXIS 262 from a WAN. In the example shown below, NAT traversal will enable the PC located on the WAN to access the camera and the AXIS 262, which are located on the LAN.

In the router, port 80 can be mapped to some other port number, e.g. 8080 and port 2000 should be mapped to 2000. When this has been done, the user on the PC can access the AXIS 262 by typing the following URL in the browser: `http://212.10.10.10:8080`

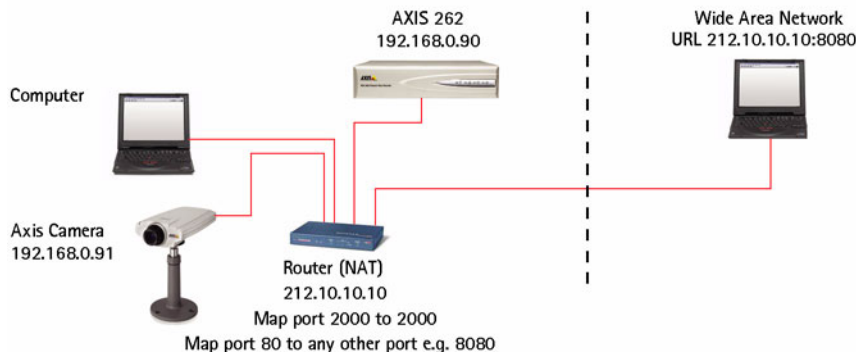

**Note:** The camera link button may not function in the Main View when using NAT traversal. You can type the IP address of the camera directly in Internet Explorer along with the port number that port 80 of the camera is mapped to in the router.

## Support

If you contact Axis support, please help us help you resolve your problems by providing a log file, server report and a brief description of the problem.

Log file - go to  > Logs & Reports > Logs. The Log file records events within the unit and can prove a useful diagnostic tool for troubleshooting.

Server Report - go to  > Logs & Reports > Server Report. The server report contains important information about the server and its software, as well as a list of the current parameters.

## Symptoms, Possible Causes and Remedial Actions

### The AXIS 262 cannot be accessed from a Web browser

|                           |   |
|---------------------------|---|
| Proxy server              | If using a proxy server, try disabling the proxy setting in your browser. |
| Other networking problems | Test the network cable by connecting it to another network device.        |

### Web pages do not display correctly

|                                   |  |
|-----------------------------------|--|
| The network is too heavily loaded | This may be due to insufficient bandwidth. |
|-----------------------------------|--|

### Recording cannot be found

|                      |   |
|----------------------|---|
| Time has been edited | <p>If you manually edit the time under <b>Date &amp; Time</b>, it may not be possible to find certain recordings when searching using a specific date and time. Editing the time can result in two recordings being saved with the same time and date.</p> <p>The recording is still present on the hard disk and can be viewed by starting playback at the previous recording.</p> |
|----------------------|---|

### Video is not displayed

|                   |  |
|-------------------|--|
| ActiveX component | <p>The ActiveX component is software that enables the viewing of live video on Windows. If the ActiveX component is not properly installed, video will not be displayed.</p> <p>To install the ActiveX component, open the Security tab in Internet Options in Internet Explorer. Then temporarily lower the security level for this zone to a level where it will be possible to install the ActiveX component. Now access the Main View page again to install the component.</p> <p>After the ActiveX component has been successfully installed, return the security level to its previous setting.</p> <p>Note that installing the ActiveX component requires Administrator privileges on the PC.</p> |
| Too many users    | The maximum number of users guaranteed to be able view video simultaneously is 4.  |
| Network problems  | <p>The AXIS 262 uses ports 80 and 2000 for viewing video. If web pages are available, but video is not, check that port 2000 has not been blocked.</p> <p>The network cameras/video servers that the AXIS 262 records from must be accessible on port 80.</p> <p>You may need to contact your network administrator.</p>   |

### AXIS 262 works locally, but not externally

|                             |   |
|-----------------------------|---|
| Incorrect firewall settings | Check if there are firewall settings that need to be adjusted. See also <b>Network problems</b> above.                                    |
| Network settings            | Check if there are router and subnet mask settings that need to be configured. See the TCP/IP Network Settings page for more information. |

### Manual recording cannot be started

|              |  |
|--------------|--|
| User account | Check that you are logged in as an administrator or operator. If anonymous viewers is enabled, this option is not available. |
|--------------|--|

### AXIS 262 cannot be accessed via a host name

|                |   |
|----------------|---|
| Settings error | Check that the host name and DNS server settings are correct. |
|----------------|---|

### Image problems

|  |  |
|--|--|
| No image using Refresh and/or slow updating of image | <p>If images are very complex, try limiting the number of clients accessing the AXIS 262.</p> <p>Check that sufficient bandwidth is available, and also that the PC used for viewing meets the specified requirements.</p> |
| Blurred images                                       | Please refer to the troubleshooting page for the connected camera.   |
| Poor image quality                                   | Please refer to the troubleshooting page for the connected camera.   |
| Rolling dark bands or flickering in image            | Please refer to the troubleshooting page for the connected camera.   |



The image frame rate is not as high as expected

This may be due to:

- using a PC that does not meet the recommended specifications
- insufficient bandwidth
- incorrect settings in the connected camera and/or the AXIS 262

## Spare parts

The following spare parts are available for the AXIS 262:

- 5002-001 ACC MAINS ADAPTOR AXIS 262
- 5002-011 ACC HARDDISK 160GB AXIS 262
- 5002-021 ACC FAN SYSTEM AXIS 262
- 5002-031 ACC FAN CPU AXIS 262

For additional assistance, please contact your reseller or check the product's support pages on the Axis Website at [www.axis.com/techsup](http://www.axis.com/techsup)

## Technical Specifications

| Item                       | Specification  |
|----------------------------|--|
| Video compression          | Motion JPEG  |
| Compatibility              | Compatible with all Axis network video products running firmware 4.15 and higher.  |
| Recording frame rate       | <ul style="list-style-type: none"> <li>• Up to 240 frames per second in QVGA or CIF</li> <li>• Up to 100 frames per second in VGA or 4CIF</li> </ul>   |
| Recording storage          | 160 GB hard disk drive with Anti-Vibration   |
| Video channels             | 8 video channels   |
| Resolution                 | Up to and exceeding 1280x1024 (always the same as camera's resolution, with no degradation).   |
| Camera live view           | All cameras can be monitored through AXIS 262.   |
| Live sequence mode         | Several configuration options for how the AXIS 262 will sequence through the video sources.  |
| Audio Support              | Full duplex live audio support through direct connection to audio enabled cameras and servers. No audio recording.   |
| PTZ support                | Control of all Axis PTZ and dome cameras through direct connection to camera.  |
| Alarm recording            | Recordings can be started by HTTP notification from a network camera/video server or by a trigger from a digital input on the AXIS 262.  |
| Alarm recording frame rate | The frame rate for alarm recordings can be specified independently from the frame rate of scheduled recordings.  |
| Scheduled recording        | Recordings can be scheduled for the various video sources, with different frame rates.   |
| Manual recording           | Capability to manually start a recording with a predefined frame rate.   |
| Playback                   | Playback of recorded material, fast forward, fast reverse, single step forward and reverse.  |
| Synchronized playback      | Playback of video synchronized in time from up to 4 video sources simultaneously.  |
| Search for recordings      | Search for recordings based on date and time.  |
| Video clip export          | Part of a recording can be downloaded to a remote computer.  |
| Time synchronization       | Date and time in the cameras and video servers are synchronized with the date and time in the AXIS 262. The date and time in the AXIS 262 can be synchronized with an external NTP server.   |
| Daylight saving time       | Different time zones are supported.  |
| System alarm notification  | <ul style="list-style-type: none"> <li>• Output 1: Alarm recording status</li> <li>• Output 2: Channel lost status</li> <li>• Output 3: Hard disk error</li> <li>• Output 4: Hard disk full</li> <li>• Alarm notification via email if failure on hard disk or system</li> </ul> |
| Security                   | Multiple user access levels with password protection   |
| Connectors                 | <ul style="list-style-type: none"> <li>• Ethernet 10BaseT/100BaseTX, RJ-45</li> <li>• Terminal block: 4 alarm inputs, 4 outputs</li> <li>• D-Sub for RS-232 port for UPS (Uninterruptible Power Supply)</li> </ul>   |

| Item                                     | Specification   |
|--|---|
| Processors and memory                    | <ul style="list-style-type: none"> <li>• CPU: VIA C3</li> <li>• RAM: 256 MB</li> <li>• Flash: 128 MB</li> </ul>   |
| Power                                    | 12 V DC, max 50 W (typically 40 W)  |
| Operating conditions                     | 5 - 40°C (41 - 104°F), humidity 20 - 80% RH (non condensing)  |
| Language support                         | English, German and Japanese (automatic selection)  |
| Installation, management and maintenance | Installation tool on a CD and Web-based configuration. Support for firmware upgrades over HTTP; firmware available at <a href="http://www.axis.com">www.axis.com</a>  |
| Video access from Web browser            | Full control through the Web browser  |
| Minimum Web browsing requirements        | <ul style="list-style-type: none"> <li>• Pentium 4 CPU 2 GHz or higher, or equivalent AMD</li> <li>• 512 MB RAM</li> <li>• AGP graphic card, Direct Draw, 32 MB RAM</li> <li>• Windows XP Pro, DirectX 9.0 or later, Internet Explorer 6.x or later</li> </ul>  |
| System integration support               | <ul style="list-style-type: none"> <li>• Powerful API for software integration is available at <a href="http://www.axis.com">www.axis.com</a> including HTTP API</li> <li>• Embedded operating system: Linux 2.4</li> <li>• The AXIS 262 can be configured to send a TCP notification when an alarm recording starts and stops</li> </ul> |
| Supported protocols                      | HTTP, TCP, SMTP, DHCP, ARP, DNS, NTP. More information on protocol usage available at <a href="http://www.axis.com">www.axis.com</a>  |
| Included accessories                     | <ul style="list-style-type: none"> <li>• Power supply 12 V DC</li> <li>• Power cables for Germany, UK and Japan</li> <li>• Installation Guide</li> <li>• CD with installation tool and User's Manual</li> </ul>   |
| Approvals                                | <ul style="list-style-type: none"> <li>• EMC: EN55022: 1998 Class B</li> <li>• EN61000-3-2</li> <li>• EN61000-3-3</li> <li>• EN61000-4-2</li> <li>• EN61000-4-3</li> <li>• EN61000-4-4</li> <li>• EN61000-4-5</li> <li>• EN61000-4-6</li> <li>• EN61000-4-11</li> <li>• EN 55024:1998, VCCI</li> <li>• Safety: EN60950</li> </ul>         |
| Dimensions (HxWxD) and weight            | <ul style="list-style-type: none"> <li>• 70 x 310 x 290 mm (22/4" x 123/16" x 117/16")</li> <li>• 5 kg (11 lbs) excluding power supply</li> </ul>   |

# Glossary

---

**Active Speaker** - a speaker with a built-in power amplifier.

**ActiveX** - A control (or set of rules) used by a browser. ActiveX controls are often downloaded and installed automatically as required.

**ADPCM** - Adaptive Differential Pulse Code Modulation. Predicts the analog signal digitally and the difference is coded.

**AMC** - AXIS Media Control. The control required for viewing video images in Internet Explorer. Installs automatically on first use.

**API** - Application Programming Interface. The Axis API can be used for integrating Axis products into other applications.

**ARP** - Address Resolution Protocol. A protocol for assigning an IP address to a physical device address that is recognized in the local network. The ARP command can be used to set the IP-address for your product.

**ARTPEC** - Axis Real Time Picture Encoder - used for video image compression.

**Axis 262 Commander** - ActiveX component used in the Main View.

**CCD** - Charge Coupled Device. CCD is one of the two main types of image sensors used in digital cameras. When a picture is taken, the CCD is struck by light coming through the camera's lens. Each of the thousands or millions of tiny pixels that make up the CCD convert this light into electrons.

**CGI** - Common Gateway Interface. A set of rules (or a program) that allows a Web Server to communicate with other programs.

**Client/Server** - Describes the network relationship between two computer programs in which one, the client, makes a service request from another - the server.

**dB (Decibels)** - A unit to measure sound level changes. A 3dB change is the smallest level change we can hear. A 3dB change is actually twice or half the audio power level. A gain of 0dB will leave the signal level unchanged.

**DC-Iris** - This special type of iris is electrically controlled by the Axis camera, to automatically regulate the amount of light allowed to enter.

**De-interlacing** - An image quality improvement process taking a stream of interlaced frames and converting it to a stream of progressive frames.

**DNS** - The Domain Name System (DNS) locates and translates Internet domain names into IP (Internet Protocol) addresses.

**Ethernet** - A widely used networking standard.

**ETRAX** - Axis' own microprocessor.

**Firewall** - A virtual barrier between a LAN (Local Area Network) and other networks, e.g. the Internet.

**FTP** - File Transfer Protocol. Used for the simple transfer of files to and from an FTP-server.

**FPS** - Frames per second.

**Full duplex** - Transmission of data, e.g. audio, in two directions simultaneously.

**G.711** - G.711 is the international standard for encoding telephone audio on 64 kBit/s channel. It is a pulse code modulation (PCM) scheme operating at 8 kHz sample rate.

**G.726** - Frequently used speech-compression algorithm in telecommunications due to its high perceived speech quality and low resource requirements.

**HAD** - Hole Accumulation Diode. A HAD CCD design allows for more light to reach the imager, which reduces video noise to improve signal-to-noise ratio by up to 6dB (2x better than a standard CCD imager). Particularly effective when shooting in dark situations.

**Half duplex**- A half duplex link can communicate in only one direction, at a time. Two way communication is possible, but not simultaneously. Walkie-talkies and CB radios mimic this behavior in that you cannot hear the other person if you are talking.

**HTML** - Hypertext Mark-up Language. Used widely for authoring documents viewed in web browsers.

**HTTP** - Hypertext Transfer Protocol. The set of rules for exchanging files (text, images, sound, video, and other files) on the World Wide Web.

**Intranet** - A private network limited to an organization or corporation. Usually closed to external traffic.

**IP** - Internet-Protocol. See TCP/IP.

**IP address** - A unique number used by a network device, to allow it to be identified and found on the network. The 32-bit IP address is made up of four groups (or quads) of decimal digits separated by periods. An example of an IP address is: 192.168.0.1

**ISMA** - Internet Streaming Media Alliance

**JPEG** - A standard image format, used widely for photographs. Also known as JPG.

**LAN** - A local area network (LAN) is a group of computers and associated devices that typically share common resources within a limited geographical area.

**Linux** - A popular operating system, which is "open source" and practically free of charge.

**Lux** - A standard unit for the measurement of light, where 1 Lux equals the light emitted from a single candle at a distance of one meter.

**Mbit/s** - Megabits per second. A unit for measuring

speeds in networks. A LAN might run at 10 or 100 Mbit/s.

**MPEG-4** - A standard video format, used for low bandwidth video streams.

**Multicast** - The same information is sent only once and only to the intended recipients.

**NAT** - Network Address Translation is a standard used to allow multiple PCs on a private network to share a single, globally routable IP address.

**NTSC** - National Television Standards Committee. NTSC is the standard format used for televisions in most of North and Central America, and Japan.

**NTP** - Network Time Protocol. Protocol designed to synchronize the clocks of computers over a network.

**NWAY** - A network protocol that automatically negotiates the highest possible common transmission speed between two devices.

**PAL** - Phase Altering Line. PAL is the standard format used for televisions in most of the world (other than the US, Canada, and Japan).

**PCM** - Pulse Code Modulation. Analog signal converted directly to a digital.

**Ping** - A small utility used for sending data packets to network resources to check that they are working and that the network is intact.

**Pre/post alarm image** - The images from immediately before and after an alarm.

**Protocol** - A special set of rules governing how two entities will communicate. Protocols are found at many levels of communication, and there are hardware protocols and software protocols.

**Router** - A device that determines the next network point to which a packet should be forwarded on its way to its final destination. A router is often included as part of a network switch (see below).

**RTP** - Real-Time Transfer Protocol. A transfer protocol designed for delivery of live contents, e.g. MPEG-4.

**Simplex** - In simplex operation, a network cable or communications channel can only send information in one direction.

**SMTP** - Simple Mail Transfer Protocol is the protocol used to send e-mail across the Internet. SMTP authentication is a way of allowing people outside of a domain to use an SMTP server when sending e-mail.

**Subnet Mask** - An IP address consists of two components: the network address and the host address. 'Subnetting' enables a network administrator to further divide the host part of the address into two or more subnets. The subnet mask identifies the subnet to which an IP address belongs.

**Switch** - Whilst a simple hub transmits all data to all

devices connected to it, a switch only transmits the data to the device it is specifically intended for.

**TCP/IP** - Transmission Control Protocol/Internet Protocol. A suite of network protocols that determine how data is transmitted. TCP/IP is used on many networks, including the Internet. TCP keeps track of the individual packets of information and IP contains the rules for how the packets are actually sent and received.

**URL** - Uniform Resource Locator. An "address" on the network.

**Varifocal** - A varifocal lens provides a wide range of focal lengths, as opposed to a lens with a fixed focal length, which only provides one.

**WAN** - Wide-Area-Network. Similar to a LAN, but on a larger geographical scale.

**Web server** - A program on a computer (server) providing the resources (e.g. web pages) requested by the user (client).



