

Panasonic[®]

Operating Instructions

Integrated Telephone System

Model No. **KX-TS4100**

4 LINE



Please read these Operating Instructions before using the unit and save for future reference.

For assistance, visit our website:

<http://www.panasonic.com/phonehelp> for customers in the U.S.A. or Puerto Rico.

Table of Contents

Introduction

Introduction	4
Accessory information	5
Included accessories	5
Additional/replacement accessories	5
Sales and support information	5
Important safety instructions	6
For best performance	8

Preparation

Symbols used in these operating instructions	9
Display	9
Location of controls	10
Battery installation	12
Setup	13
Connecting the handset and AC adaptor	14
Connecting the telephone line cords	15
Connecting the units to individual two-line telephone jacks	15
Connecting 2 two-line telephone jacks	16
Connecting four single-line telephone jacks	17
If you subscribe to a DSL service	18
Connecting 2 two-line telephone jacks	18
Connecting four single-line telephone jacks	19
Setting up the line group	20
Connecting a communication device	22
Setting the unit before use	23
Display language	23
Extension No.	23
Date and time	24
Dialing mode	24

Making/Answering Calls

Making calls	25
Answering calls	26
Turning ringer on/off	26
Ringer type	27
Turning Do Not Disturb (DND) on/off	27
Making/answering another outside call during a conversation	28
Useful features during a call	28
Call privacy	28
HOLD button	28

Hold reminder	29
MUTE button	29
FLASH button	29
Flash time	30
Temporary tone dialing (for rotary/pulse service users)	30

Speed Dialer

Speed dialer	31
Speed dial preference	31
Adding/editing names and phone numbers	31
Storing items from the redial list into the speed dialer	32
Erasing a stored entry	33
Calling someone with the speed dialer	34

Multi-unit Operation

Intercom/Paging	35
Making an intercom call	35
Answering an intercom call	35
Paging a designated extension	36
Answering a single page	36
Paging all extensions	36
Answering all pages	36
Room monitor	37
Transferring calls	37
Answering transferred calls	38
Conference calls	38

Programming

Programmable settings	40
Programming the phone setup features	42
Prime line	42
Handsfree mode	42
Programming the advanced setup features	43
Line group	43
Reset all	43

Useful Information

Headset (optional)	44
Sales and support information	44
Connecting the optional headset to the unit	44
Wall mounting	45
Connecting a standard telephone	47
Error messages	48
Troubleshooting	49

FCC and other information	51
Specifications	53
Customer services	54
Warranty	55
Index	
Index	57

Introduction

Thank you for purchasing a Panasonic integrated telephone.

We recommend keeping a record of the following information for future reference.

Serial No. _____

Date of purchase _____

(found on the bottom of the unit)

Name and address of dealer _____

┌-----┐
| **Attach your purchase receipt here.** |
└-----┘

Accessory information

Included accessories

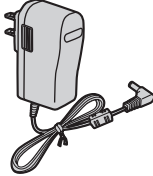
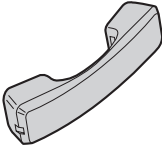
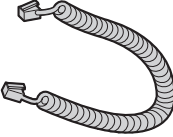
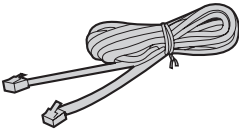
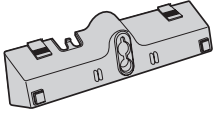
<input type="checkbox"/> AC adaptor Order No. PQLV210Z  one	<input type="checkbox"/> Handset Order No. PQJXC0401Z (Black)  one
<input type="checkbox"/> Handset cord Order No. PQJA212N (Gray)  one	<input type="checkbox"/> 4-wire telephone line cord Order No. PQJA10088Z  two
<input type="checkbox"/> Wall mounting adaptor Order No. PQYL10021Z  one	

Additional/replacement accessories

Accessory item	Order number
Headset	KX-TCA86, KX-TCA88HA, KX-TCA91, KX-TCA92, KX-TCA93, KX-TCA94, or KX-TCA95
2-line adaptor	KX-J24
2-line splitter	KX-J42
T-adaptor	KX-J66
2-wire telephone line cord	PQJA10075Z
9 V Alkaline (6LR61) back-up battery	Use standard store bought 9 V Alkaline battery

Sales and support information

- To order additional/replacement accessories, call 1-800-332-5368.
- TTY users (hearing or speech impaired users) can call 1-866-605-1277.

Important safety instructions

When using the product, basic safety precautions should always be followed to reduce the risk of fire, electric shock, or personal injury.

1. Read all instructions carefully.
2. Follow all warnings and instructions marked on the product.
3. Unplug the product from power outlets before cleaning. Do not use liquid or aerosol cleaners. Use a moist cloth for cleaning.
4. Do not use the product near water, for example near a bathtub, wash bowl, kitchen sink, etc.
5. Place the product securely on a stable surface. Serious damage and/or injury may result if the product falls.
6. Do not cover slots and openings on the product. They are provided for ventilation and protection against overheating. Never place the product near radiators, or in a place where proper ventilation is not provided.
7. Use only the power source marked on the product. If you are not sure of the type of power supplied to your home, consult your dealer or local power company.
8. Do not place objects on the power cord. Install the product where no one can step or trip on the cord.
9. Do not overload power outlets and extension cords. This can result in the risk of fire or electric shock.
10. Never push any objects through slots in the product. This may result in the risk of fire or electric shock. Never spill any liquid on the product.
11. To reduce the risk of electric shock, do not disassemble the product. Take the product to an authorized service center when service is required. Opening or removing

covers may expose you to dangerous voltages or other risks. Incorrect reassembly can cause electric shock when the product is subsequently used.

12. Unplug the product from power outlets and take to an authorized service center when the following conditions occur:
 - A. When the power cord is damaged or frayed.
 - B. If liquid has been spilled into the product.
 - C. If the product has been exposed to rain or water.
 - D. If the product does not work normally by following the operating instructions. Adjust only controls covered by the operating instructions. Improper adjustment may require extensive work by an authorized service center.
 - E. If the product has been dropped or physically damaged.
 - F. If the product exhibits a distinct change in performance.
13. During thunderstorms, avoid using telephones except cordless types. There may be a remote risk of an electric shock from lightning.
14. Do not use the product to report a gas leak, when in the vicinity of the leak.

SAVE THESE INSTRUCTIONS

CAUTION:

Installation

- Never install telephone wiring during a lightning storm.
- Never install telephone jacks in wet locations unless the jack is specifically designed for wet locations.
- Never touch uninsulated telephone wires or terminals unless the

telephone line has been disconnected at the network interface.

- Use caution when installing or modifying telephone lines.
- Do not touch the plug with wet hands.
- The AC adaptor is used as the main disconnect device. Ensure that the AC outlet is installed near the product and is easily accessible.

Battery

To reduce the risk of fire or injury to persons, read and follow these instructions.

- Use only the battery specified.
- Do not dispose of the battery in a fire. It may explode. Check with local waste management codes for special disposal instructions.
- Do not open or mutilate the battery. Released electrolyte is corrosive and may cause burns or injury to the eyes or skin. The electrolyte may be toxic if swallowed.
- Exercise care when handling the battery in order not to short the battery to conductive materials such as rings, bracelets, and keys. The battery and/or conductor may overheat and cause burns.
- Do not recharge the battery provided with or identified for use with the product. The battery may leak corrosive electrolyte or explode.
- Do not attempt to rejuvenate the battery provided with or identified for use with the product by heating. Sudden release of battery electrolyte may occur causing burns or irritation to the eyes or skin.
- Remove the battery from the product if the product will not be used for a long period of time (several months or more). During this time the battery could leak in the product.
- Discard the "dead" battery as soon as possible. The "dead" battery may leak in the product.

- Do not store the product, or the battery provided with or identified for use with the product, in high temperature areas. A battery that is stored in a freezer or refrigerator for the purpose of extending shelf life should be protected from condensation during storage and defrosting. A battery should be stabilized at room temperature prior to use after cold storage.

WARNING:

- To prevent the risk of fire or electrical shock, do not expose the product to rain or any type of moisture.
- Unplug the product from power outlets if it emits smoke, an abnormal smell, or makes an unusual noise. These conditions can cause fire or electric shock. Confirm that smoke has stopped emitting and contact the Panasonic Call Center at 1-800-211-PANA (1-800-211-7262).

For best performance

Environment

- Keep the product away from electrical noise generating devices, such as fluorescent lamps and motors.
- The product should be kept free from excessive smoke, dust, high temperature, and vibration.
- The product should not be exposed to direct sunlight.
- Do not place heavy objects on top of the product.
- When you leave the product unused for a long period of time, unplug the product from the power outlet.
- The product should be kept away from heat sources such as heaters, kitchen stoves, etc. It should not be placed in rooms where the temperature is less than 5 °C (41 °F) or greater than 40 °C (104 °F). Damp basements should also be avoided.

Routine care

- Wipe the outer surface of the product with a soft moist cloth. Do not use benzine, thinner, or any abrasive powder.

Symbols used in these operating instructions

Symbol	Meaning
[] : button name Example: [MENU/SET], [SP-PHONE]	The words in the brackets indicate button names on the unit.
Example: "Ringer Type"	The words in quotations indicate the menu on the display.
Example: Select "Phone Setup".	Press [▼] or [▲] to select "Phone Setup".
[▼] [▲] [◀] [▶]	Press down, up, left, or right on the navigator key.

Display

Example:

03:45P 02/23 MON	— The current date and time
EXT 11	— The extension number of this phone

Location of controls

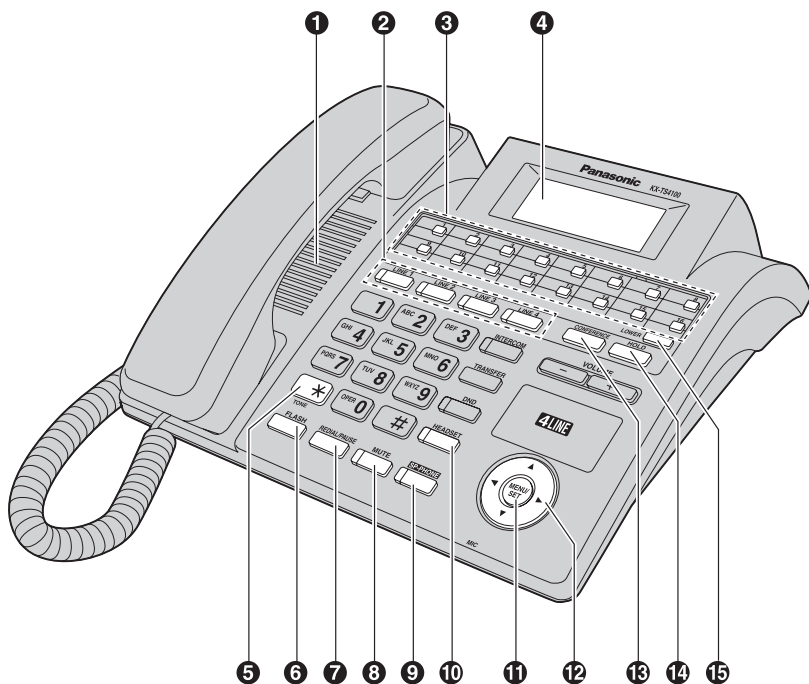

- ❶ Speaker
- ❷ Line buttons and indicators
- ❸ Speed dial (extension) buttons
- ❹ Display
- ❺ [*] (TONE)
- ❻ [FLASH]
- ❼ [REDIAL/PAUSE]
- ❽ [MUTE]
MUTE indicator
- ❾ [SP-PHONE] (Speakerphone)
SP-PHONE indicator
- ❿ [HEADSET]
HEADSET indicator
- ⓫ [MENU/SET]
- ⓬ Navigator key ([▼] [▲] [◀] [▶])
- ⓭ [CONFERENCE]
- ⓮ [HOLD]
- ⓯ [LOWER]



16 Headset jack

17 Volume key ([-] [+])

18 [INTERCOM]
INTERCOM indicator

19 [TRANSFER]

20 [DND] (Do Not Disturb)
DND indicator

21 MIC (Microphone)

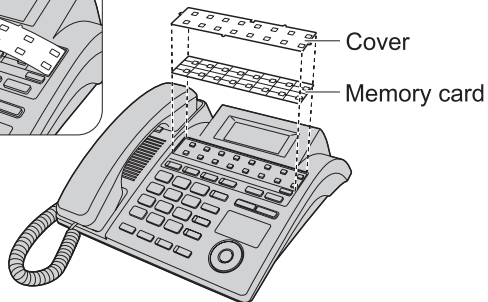
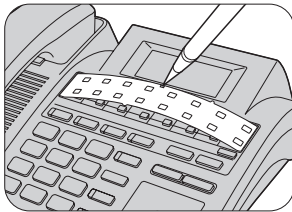

Memory card:

Remove the memory card and use it as a name index for speed dialer or extensions.

Battery installation

Install a 9 V Alkaline (6LR61) battery (sold separately) in the battery compartment. It works as emergency power during a power failure. The unit will work as a standard telephone, so that you can make or answer outside calls with the handset. (You cannot use the speakerphone, intercom, etc.)

- 1 Open the battery cover by sliding in the direction of arrow (①), and take out the battery snap (②).

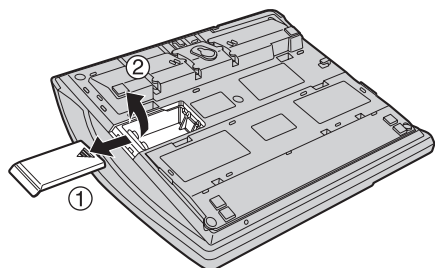

- 2 Match the polarity and snap the battery to the battery snap as shown.

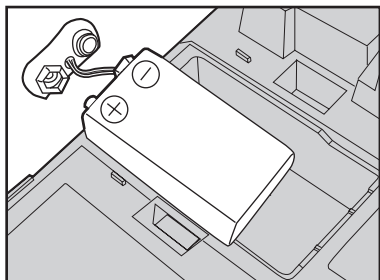

- 3 Place the battery into the battery compartment.
- 4 Dress the battery snap wire, and close the battery cover.

Note:

- Please refer to “Battery” on page 7 for correct battery usage.
- When the display shows “LOW BATT” with a 9 V battery in the unit, the battery needs to be changed immediately. If the battery level is too low, all LEDs might light up or flash

and the unit is not guaranteed to perform as normal during a power failure. Replacing with a fresh battery will restore normal function.

- The Manganese (6F22) battery can be used but operating time when using it will be dramatically shortened.
- It is recommended that the battery is replaced annually.
- It is recommended that the battery is replaced after a power outage.
- The battery operating time may depend on usage conditions, ambient temperature, and battery quality.
- During a power failure the battery will retain the clock memory (see “Date and time” on page 24) and the redial memory (see “Making a call using the redial list” on page 25). If you do not install the battery, the data in memory will be lost during a power failure.
- When storing or disposing of the battery, please cover the positive (+) and negative (−) terminals with tape.

Battery replacement

Disconnect the telephone line cord(s) before opening the battery cover.

Note:

- You do not need to disconnect the AC adaptor, otherwise the clock memory and the redial memory will be lost.
- Please refer to “Battery” on page 7 for correct battery usage.

Battery life

The battery works as **emergency power** during a power failure.

Please remove the battery when you cut the power supply, as the battery will discharge automatically once the power is cut according to the time as follows.

Operation	Operating time (for a Panasonic Alkaline battery)
While in use (talking)	Approx. 3 hours
While not in use (standby)	Approx. 4 hours

Setup

This unit can be used in 3 positions.

On the desk

– Normal (without the wall mounting adaptor)

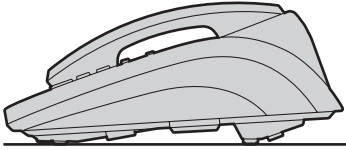

– With the wall mounting adaptor

You can attach the wall mounting adaptor to slope this unit.

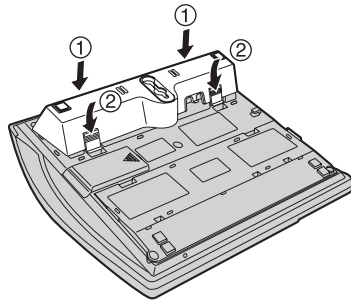
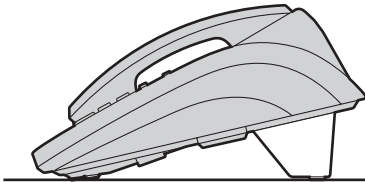

- To attach the wall mounting adaptor, push it in the direction of the arrows (① and ②) as shown.

On the wall

See “Wall mounting” on page 45 for details.

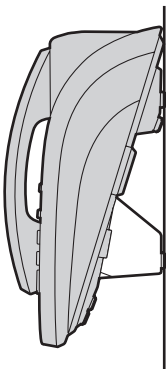

Connecting the handset and AC adaptor

Important:

- Use only the included Panasonic handset PQJXC0401Z.
- Use only the included Panasonic AC adaptor PQLV210Z.

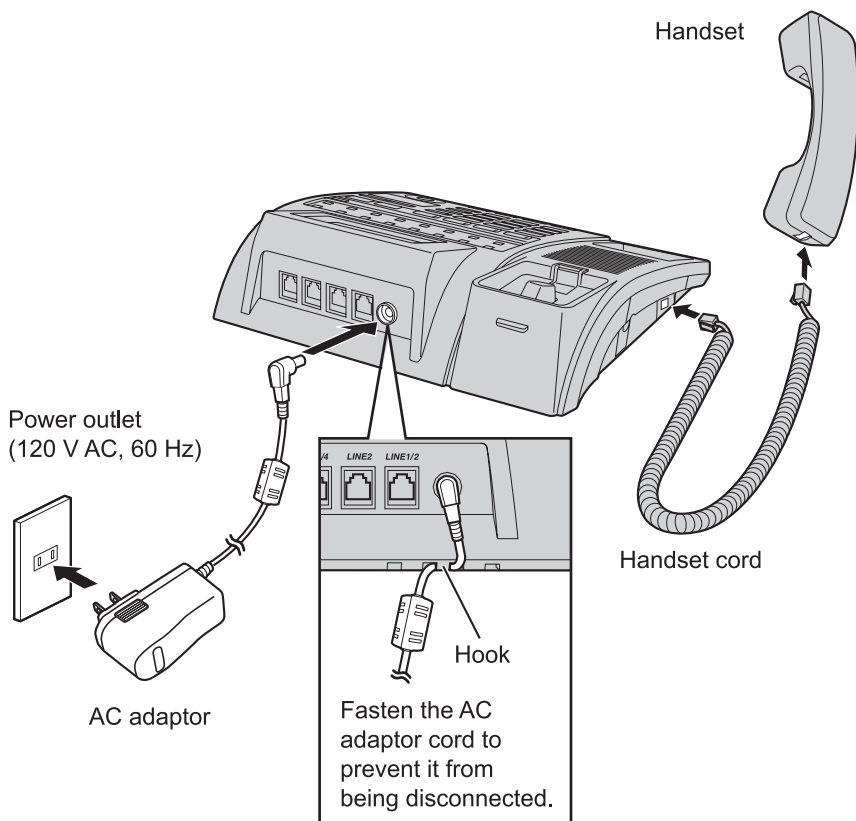

Note:

- The AC adaptor must remain connected at all times. (It is normal for the adaptor to feel warm during use.)
- The AC adaptor should be connected to a vertically oriented or floor-mounted AC outlet. Do not connect the AC adaptor to a ceiling-mounted AC outlet, as the weight of the adaptor may cause it to become disconnected.
- The unit will not work during a power failure. We recommend connecting a standard telephone to the same telephone line or to the same telephone jack using a Panasonic T-adaptor KX-J66 (see "Connecting a standard telephone" on page 47). Emergency power can be supplied to the unit by installing a 9 V Alkaline (6LR61) back-up battery (see "Additional/replacement accessories" on page 5).

Connecting the telephone line cords

A maximum of 16 system phones (KX-TS4100/KX-TS4200/KX-TS4300) can be connected in parallel. To use the intercom, LINE1 must be connected at all extensions, and must be the same phone number.

Connecting the units to individual two-line telephone jacks

Parallel connected
two-line telephone jacks (RJ14C)

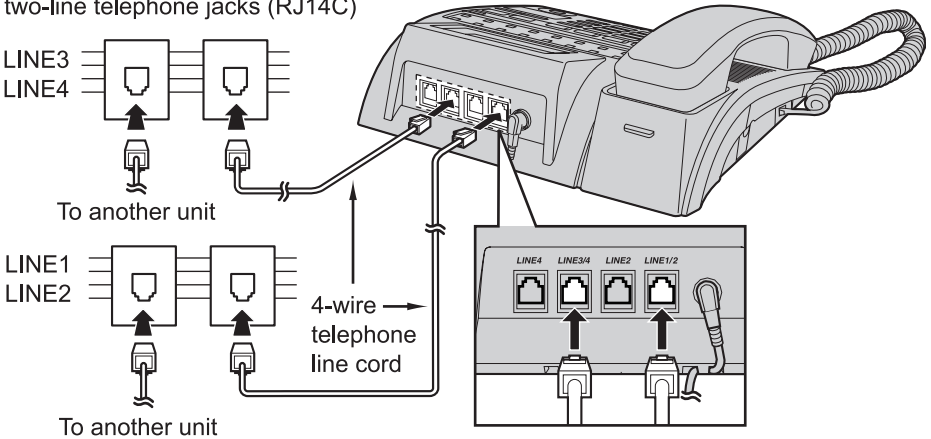

Parallel connected two-line telephone jacks (RJ14C)

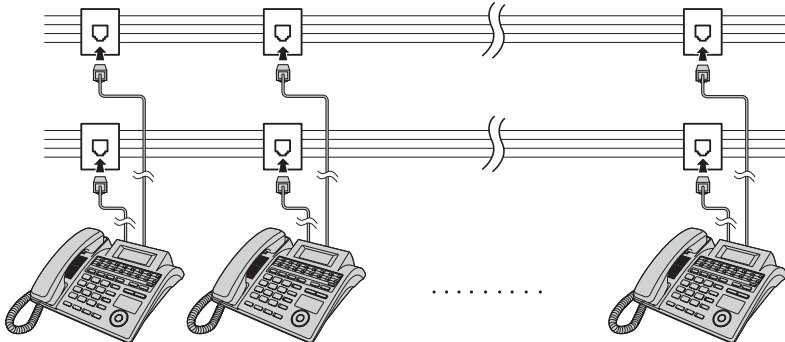

- You can connect up to 16 system phones.

Note:

- If a non-system phone is connected to the system phone (KX-TS4100/KX-TS4200/KX-TS4300), the line indicators of this unit will not function for that telephone.

DSL Internet connection and KX-TS4100/KX-TS4200/KX-TS4300 Intercom work at similar frequencies. Please contact Panasonic at 1-800-211-PANA (1-800-211-7262) for special wiring configurations.

Connecting 2 two-line telephone jacks

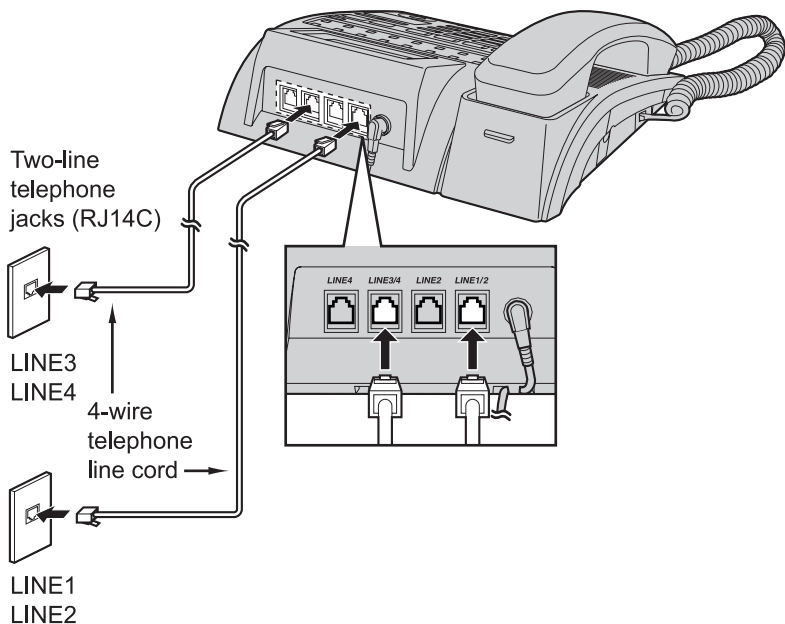

DSL Internet connection and KX-TS4100/KX-TS4200/KX-TS4300 Intercom work at similar frequencies. Please contact Panasonic at 1-800-211-PANA (1-800-211-7262) for special wiring configurations.

Connecting four single-line telephone jacks

For this connection, please purchase two Panasonic 2-line adaptors KX-J24 and two 2-wire telephone line cords (Order No. PQJA10075Z) (see "Additional/replacement accessories" on page 5).

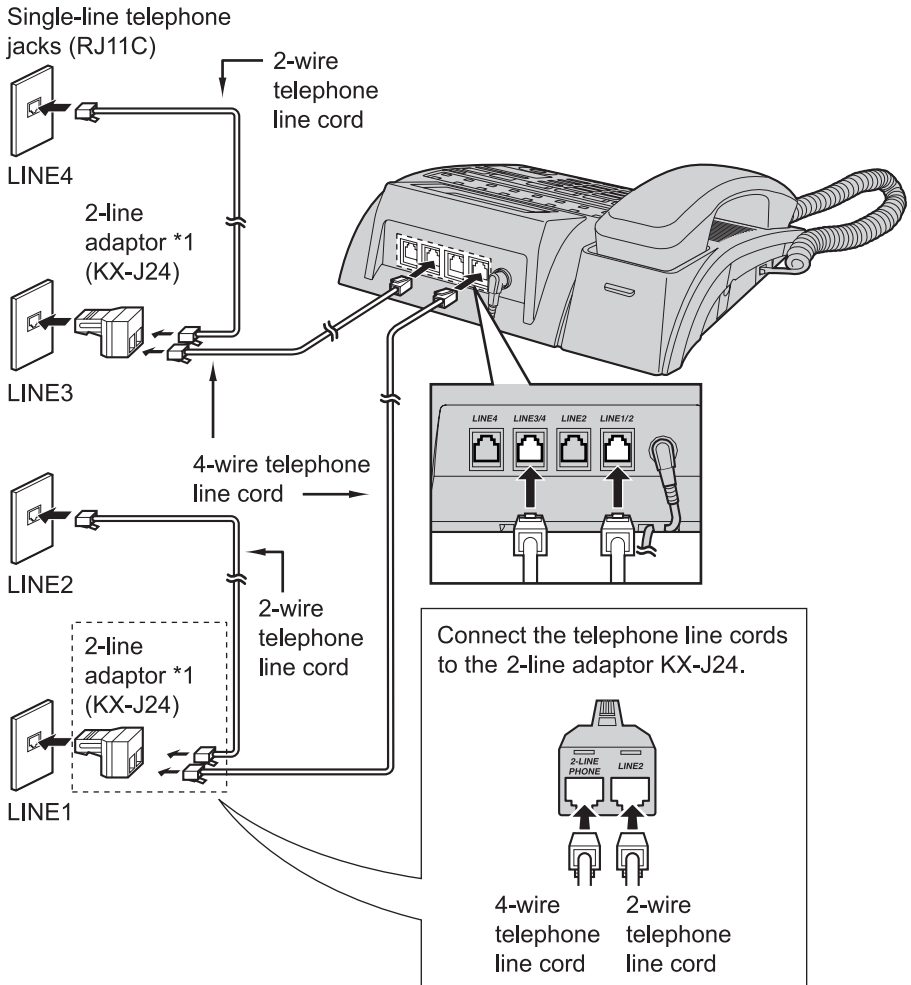

*1 2-line adaptor merges a 2-wire (single line) telephone outlet with another 2-wire (single line) telephone line onto a single 4-wire (2-line) telephone line cord.

DSL Internet connection and KX-TS4100/KX-TS4200/KX-TS4300 Intercom work at similar frequencies. Please contact Panasonic at 1-800-211-PANA (1-800-211-7262) for special wiring configurations.

If you subscribe to a DSL service

Please attach a noise filter (contact your DSL provider) to the telephone line between the unit and the telephone line jack in the event of the following:

- Noise is heard during conversations.

Connecting 2 two-line telephone jacks

For this connection, please purchase a Panasonic 2-line splitter KX-J42 and two 2-wire telephone line cords (Order No. PQJA10075Z) (see “Additional/replacement accessories” on page 5).

Example: DSL line is LINE2.

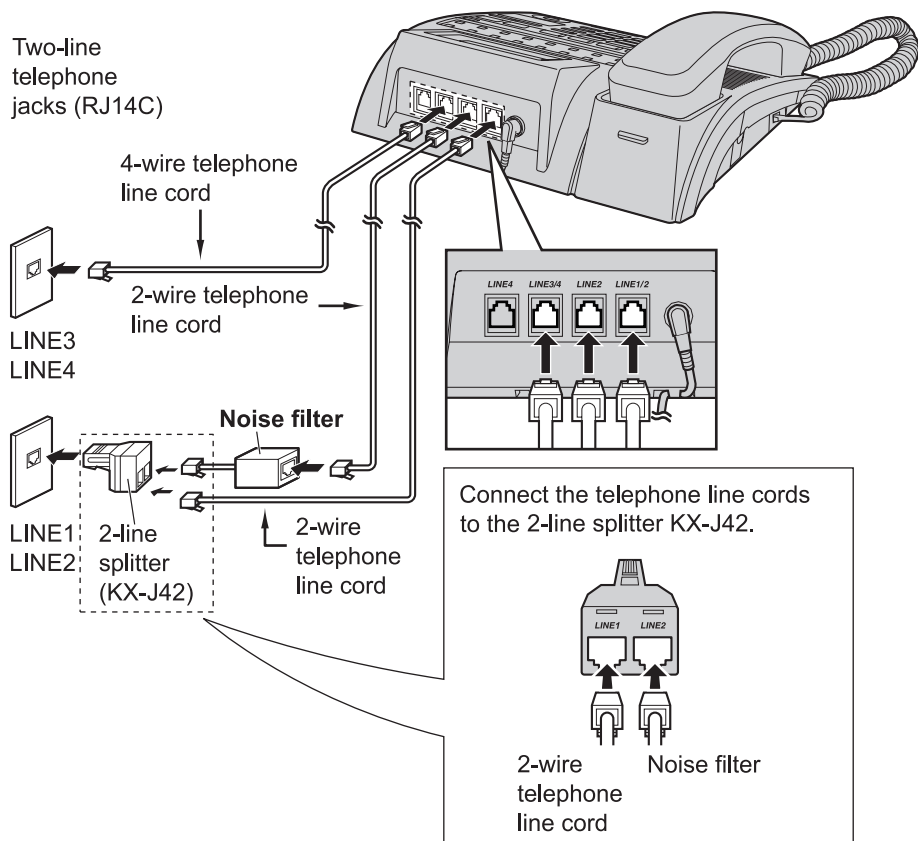

DSL Internet connection and KX-TS4100/KX-TS4200/KX-TS4300 Intercom work at similar frequencies. Please contact Panasonic at 1-800-211-PANA (1-800-211-7262) for special wiring configurations.

Connecting four single-line telephone jacks

For this connection, please purchase a Panasonic 2-line adaptor KX-J24 and three 2-wire telephone line cords (Order No. PQJA10075Z) (see “Additional/replacement accessories” on page 5).

Example: DSL line is LINE2.

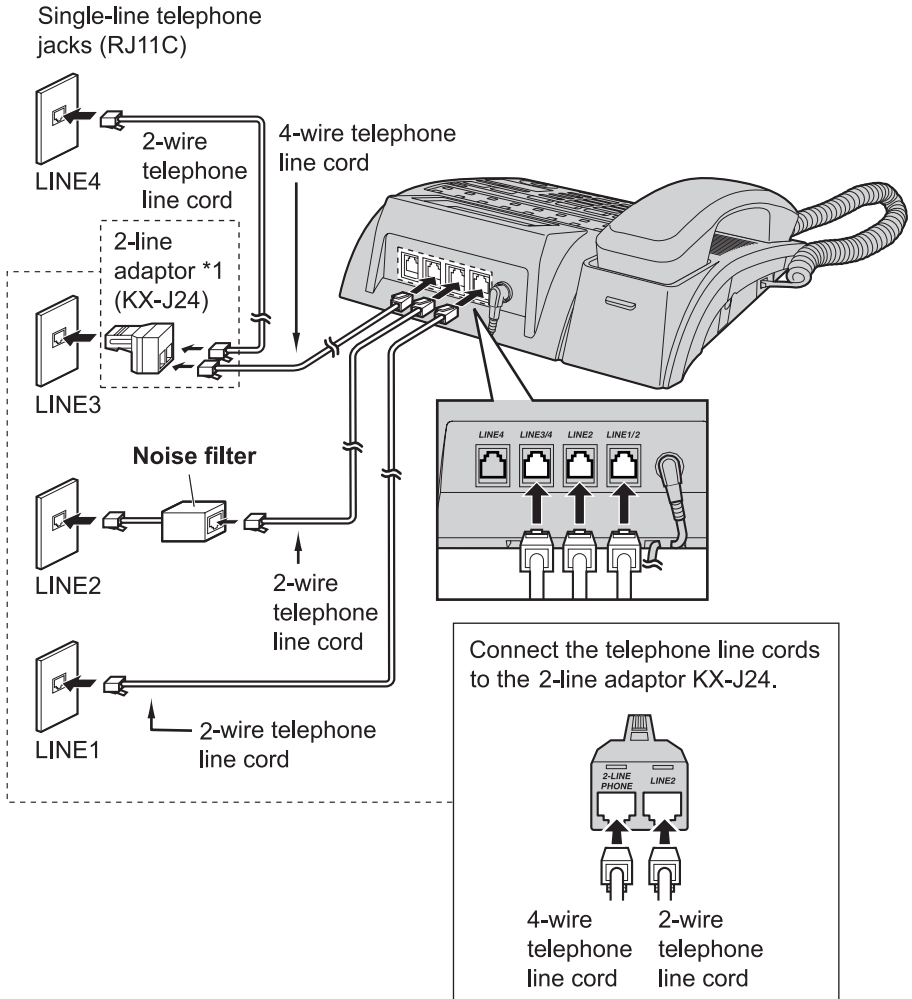

*1 2-line adaptor merges a 2-wire (single line) telephone outlet with another 2-wire (single line) telephone line onto a single 4-wire (2-line) telephone line cord.

DSL Internet connection and KX-TS4100/KX-TS4200/KX-TS4300 Intercom work at similar frequencies. Please contact Panasonic at 1-800-211-PANA (1-800-211-7262) for special wiring configurations.

Setting up the line group

If you have more than 2 system phones (KX-TS4100/KX-TS4200/KX-TS4300) and use more than 4 lines in your system phones, you can set up the line group to work correctly with the units. To program the line group, see “Line group” on page 43.

Important:

- You can set up the line group only for LINE4.

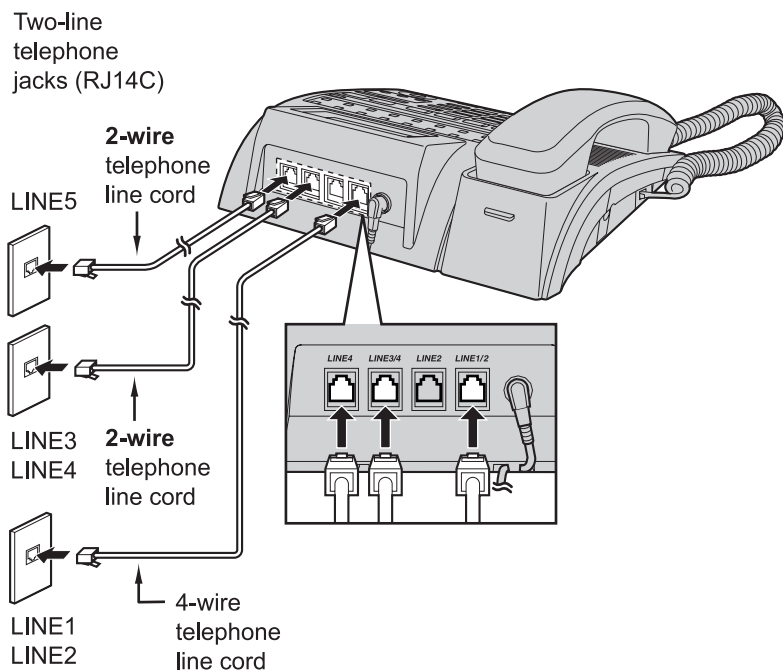

Note:

- You can set up the line group unconnected from other extensions (private line). To program the private line, see “Line group” on page 43.

DSL Internet connection and KX-TS4100/KX-TS4200/KX-TS4300 Intercom work at similar frequencies. Please contact Panasonic at 1-800-211-PANA (1-800-211-7262) for special wiring configurations.

Example:

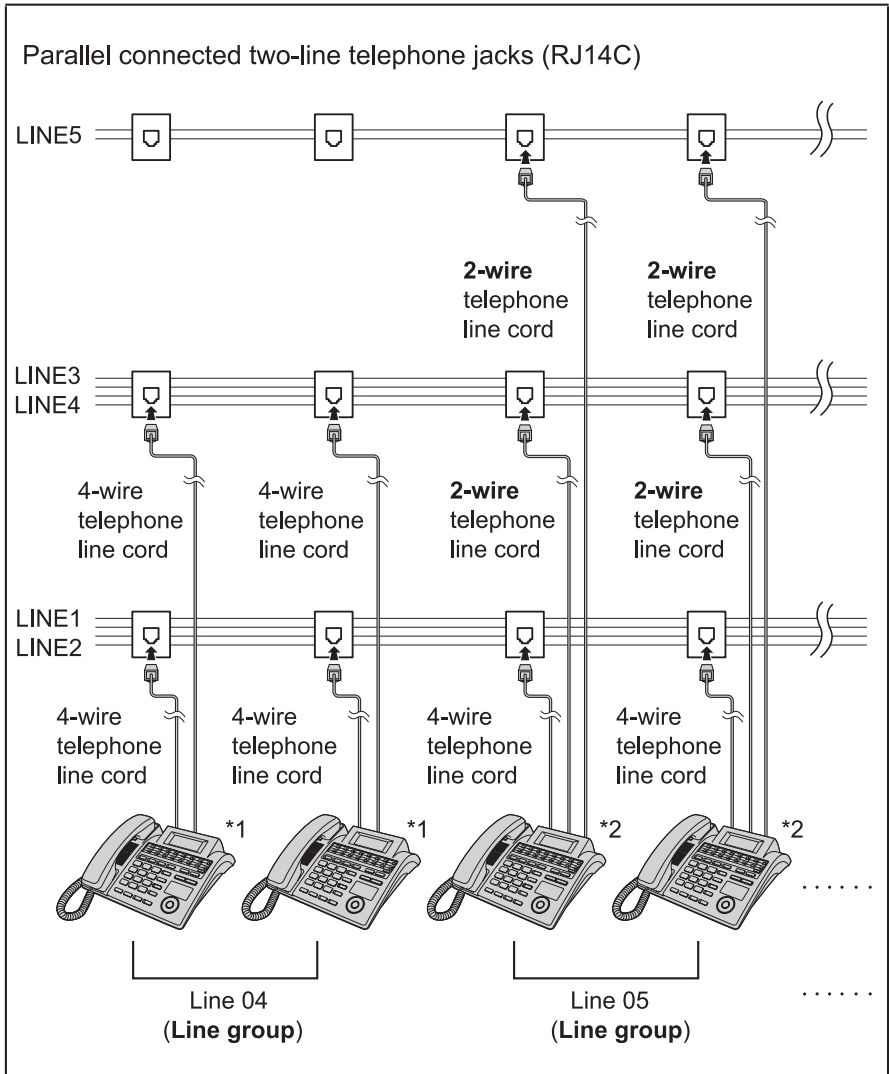

*1 This unit uses the LINE1/2 (with 4-wire telephone line cord) and LINE3/4 (with 4-wire telephone line cord) jacks.

*2 This unit uses the LINE1/2 (with 4-wire telephone line cord), LINE3/4 (with 2-wire telephone line cord), and LINE4 (with 2-wire telephone line cord) jacks.

DSL Internet connection and KX-TS4100/KX-TS4200/KX-TS4300 Intercom work at similar frequencies. Please contact Panasonic at 1-800-211-PANA (1-800-211-7262) for special wiring configurations.

Connecting a communication device

After connecting the telephone line cords to two-line telephone jacks, you can connect a communication device (computer, modem, fax, etc.) through this unit using the LINE2 or LINE4 jacks.

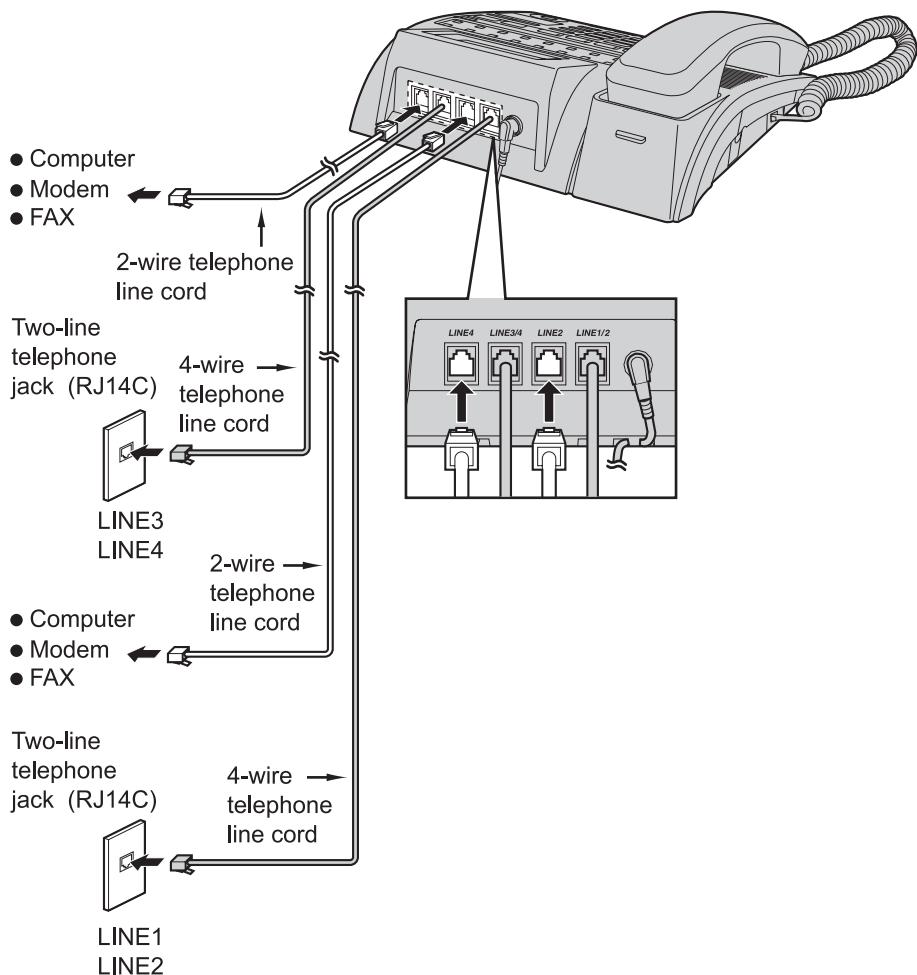

Note:

- If the communication device is in use, use LINE1 or LINE3 to make or answer other calls. Otherwise the communication device may not operate properly.

DSL Internet connection and KX-TS4100/KX-TS4200/KX-TS4300 Intercom work at similar frequencies. Please contact Panasonic at 1-800-211-PANA (1-800-211-7262) for special wiring configurations.

Setting the unit before use

Display language

Choose whether the display appears in English or Spanish. The default setting is "English".

Important:

- Make sure that the unit is in standby mode.

- 1 Press **[MENU/SET]**.
- 2 Select "Phone Setup", then press **[MENU/SET]**.
- 3 Select "Language", then press **[MENU/SET]**.

```
→Language
  Extension No.
  Date & Time
  [▼/▲]:Scroll
```

- 4 Select the desired setting, then press **[MENU/SET]**.

```
Language
=English
[SET]:Save
[▼/▲]:Change
```

- 5 Press and hold **[MENU/SET]** to return to standby mode.

Note:

- To return to the previous menu, press **[◀]**.
- If you select a language you cannot read, press **[MENU/SET]** 2 times, press **[▼]**, press **[MENU/SET]**, select the desired language, then press **[MENU/SET]**.

Extension No.

Assign the extension number ("11" to "26") to the unit to use the intercom feature. The default setting is "11".

Important:

- Make sure that the unit is in standby mode.

- 1 Press **[MENU/SET]**.
- 2 Select "Phone Setup", then press **[MENU/SET]**.
- 3 Select "Extension No.", then press **[MENU/SET]**.

```
→Extension No.
  Date & Time
  Auto Mute
  [▼/▲]:Scroll
```

- 4 Select the desired number, then press **[MENU/SET]**.

```
Extension No.
=11
[SET]:Save
[▼/▲]:Change
```

If you try to assign an extension number which is already used:

The display shows "(In Use)".

```
Extension No.
=11 (In Use)
Please Re-Assign
Another EXT#
```

Press **[▼]** or **[▲]** to select a different extension number, then press **[MENU/SET]**.

- 5 Press and hold **[MENU/SET]** to return to standby mode.

Note:

- To return to the previous menu, press **[◀]**.
- If you are going to add another station to your existing telephone system, assign a different extension number.

Date and time

Set the correct date and time.

Important:

- Make sure that the unit is in standby mode.

- 1 Press **[MENU/SET]**.
- 2 Select "Phone Setup", then press **[MENU/SET]**.
- 3 Select "Date & Time", then press **[MENU/SET]**.

→Date & Time Auto Mute Tone/Pulse [▼/▲]:Scroll

- 4 Enter the current year by selecting 2 digits, then press **[MENU/SET]**.

Example: 2006

[0][6]

- You can set the year 2000 to 2099.

- 5 Enter the current month and day by selecting 2 digits for each, then press **[MENU/SET]**.

Example: August 15

[0][8][1][5]

- 6 Enter the current hour and minute (12-hour clock format) by selecting 2 digits for each, then press **[MENU/SET]**.

Example: 9:30

[0][9][3][0]

- 7 Select "A" (AM) or "P" (PM), then press **[MENU/SET]**.

- 8 Press and hold **[MENU/SET]** to return to standby mode.

Note:

- To return to the previous menu, press **[◀]**.
- If you make a mistake when entering the date and time, press **[◀]** or **[▶]** to move the cursor, then make the correction.

Dialing mode

If you cannot make calls, change this setting depending on your telephone line service. The default setting is "Tone".

"Tone": For tone dial service.

"Pulse": For rotary pulse dial service.

Important:

- Make sure that the unit is in standby mode.

- 1 Press **[MENU/SET]**.
- 2 Select "Phone Setup", then press **[MENU/SET]**.
- 3 Select "Tone/Pulse", then press **[MENU/SET]**.

→Tone/Pulse Flash Time Hold Reminder [▼/▲]:Scroll
--

- 4 Select the desired setting, then press **[MENU/SET]**.

Tone/Pulse =Tone [SET]:Save [▼/▲]:Change

- 5 Press and hold **[MENU/SET]** to return to standby mode.

Note:

- To return to the previous menu, press **[◀]**.

Making calls

Using the handset

- 1** Lift the handset.
 - The prime line (see “Prime line” on page 42) is automatically selected and the line indicator lights.
 - The display shows the length of the call.
- 2** Dial the phone number.
 - The dialed number is displayed. If you dial a phone number longer than 15 digits, all the digits will be shifted to the left side.
- 3** When you finish talking, place the handset on the cradle.
 - The line indicator goes out.
 - The length of the call will remain on the display for a few seconds.

Note:

- The line indicator flashes while another phone is using the line.

Using the speakerphone

- 1** Press **[SP-PHONE]**.
 - The SP-PHONE indicator lights.
 - The prime line (see “Prime line” on page 42) is automatically selected and the line indicator lights.
 - The display shows the length of the call.
- 2** Dial the phone number.
 - The dialed number is displayed. If you dial a phone number longer than 15 digits, all the digits will be shifted to the left side.
 - If you misdial, press **[SP-PHONE]** and start again from step 1.
- 3** When you finish talking, press **[SP-PHONE]**.
 - The SP-PHONE and the line indicators go out.
 - The length of the call will remain on the display for a few seconds.

Note:

- The line indicator flashes while another phone is using the line.
- Use the speakerphone in a quiet environment.
- In step 1, you can select a line by pressing a line button with an unlit indicator instead of pressing **[SP-PHONE]**. Be sure that the handsfree mode is set to “Speakerphone” (see “Handsfree mode” on page 42).

Switching between handset and speakerphone

Switching from handset to speakerphone

Press **[SP-PHONE]**, then place the handset on the cradle.

Switching from speakerphone to handset

Lift the handset.

Adjusting the handset volume (5 levels) or speaker volume (8 levels)

Press **[–]** or **[+]** repeatedly while talking.

Redialing the last number dialed

- 1** Lift the handset or press **[SP-PHONE]** or a line button.
- 2** Press **[REDIAL/PAUSE]**.

Making a call using the redial list

The last 6 phone numbers dialed are stored in the redial list.

- 1** Press **[REDIAL/PAUSE]**.
- 2** Press **[▼]** or **[▲]** to select the desired number.
- 3** Lift the handset or press **[SP-PHONE]** or a line button.

Erasing a number in the redial list

Important:

- Make sure that the unit is in standby mode.

- 1 Press [**REDIAL/PAUSE**].
- 2 Press [**▼**] or [**▲**] to select the desired number, then press [**MENU/SET**].
- 3 Select "Erase", then press [**MENU/SET**].

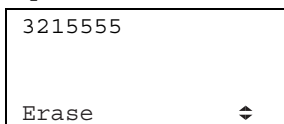

- To cancel, select "cancel", then press [**MENU/SET**].
- 4 Press [**REDIAL/PAUSE**] to return to standby mode.

Note:

- To return to the previous menu, press [**◀**].

PAUSE button (for PBX/long distance service users)

A pause is sometimes required when making calls using a PBX or long distance service.

For example, if you need to dial the line access number "9" when making outside calls with a PBX:

- 1 Lift the handset or press [**SP-PHONE**] or a line button.
- 2 Press [**9**], then press [**REDIAL/PAUSE**].
- 3 Dial the phone number.

Note:

- A 3.5 second pause is inserted each time [**REDIAL/PAUSE**] is pressed. Press repeatedly to insert longer pauses.

Answering calls

When a call is being received, the unit rings and the called line indicator flashes rapidly.

Using the handset

- 1 Lift the handset.
- 2 When you finish talking, place the handset on the cradle.

Using the speakerphone

- 1 Press [**SP-PHONE**].
- 2 Speak into the MIC.
- 3 When you finish talking, press [**SP-PHONE**].

Note:

- In step 1, you can also answer the call by pressing the flashing line button. Be sure that the handsfree mode is set to "Speakerphone" (see "Handsfree mode" on page 42).

Adjusting the ringer volume (4 levels)

Press [**-**] or [**+**] repeatedly when in standby mode.

Turning ringer on/off

Turn the ringer on/off for each line.

Important:

- Make sure that the unit is in standby mode.
- 1 Press [**MENU/SET**].
 - 2 Select "Advanced Setup", then press [**MENU/SET**].

- 3** Select "Ringer On/Off", then press **[MENU/SET]**.

```
→Ringer On/Off
  Ringer Type
  Line Group
  [▼/▲]:Scroll
```

- 4** Select the line you want to set, then press **[MENU/SET]**.

```
→Line1 Ringer
  Line2 Ringer
  Line3 Ringer
  [▼/▲]:Scroll
```

- 5** Select the desired setting, then press **[MENU/SET]**.

```
Line1 Ringer
=On
[SET]:Save
[▼/▲]:Change
```

- 6** Press and hold **[MENU/SET]** to return to standby mode.

Note:

- To return to the previous menu, press **[◀]**.

Ringer type

Select a ring pattern (4 types) for each line.

Important:

- Make sure that the unit is in standby mode.

- 1** Press **[MENU/SET]**.
- 2** Select "Advanced Setup", then press **[MENU/SET]**.
- 3** Select "Ringer Type", then press **[MENU/SET]**.

```
→Ringer Type
  Line Group
  Reset All
  [▼/▲]:Scroll
```

- 4** Select the line you want to set, then press **[MENU/SET]**.

```
→Line1 Ring Type
  Line2 Ring Type
  Line3 Ring Type
  [▼/▲]:Scroll
```

- 5** Select the desired setting, then press **[MENU/SET]**.

```
Line1 Ring Type
=Type-1
[SET]:Save
[▼/▲]:Change
```

- 6** Press and hold **[MENU/SET]** to return to standby mode.

Note:

- To return to the previous menu, press **[◀]**.
- Incoming intercom calls use Type-1 and cannot be changed.

Turning Do Not Disturb (DND) on/off

You will not hear call rings or paging when this feature is activated. The line indicator flashes for outside calls and the INTERCOM indicator flashes for intercom calls.

Press **[DND]** to turn on/off the Do Not Disturb (DND) feature.

- When the Do Not Disturb (DND) feature is turned on, the DND indicator lights and the display shows "DND".

```
03:45P 02/23 MON
DND 11
```

- When the Do Not Disturb (DND) feature is turned off, the DND indicator goes out.

Making/answering another outside call during a conversation

If you hear beeps during a conversation and another line indicator flashes rapidly, an incoming call is being received. You can answer the 2nd call while holding the 1st call.

- 1** Press **[HOLD]** to put the 1st call on hold.
 - The line indicator flashes.
 - If you press the other line button before pressing **[HOLD]**, the 1st call is disconnected.
- 2** To answer a 2nd call, press the relevant line button.

To make a 2nd call, press the other line button or **[SP-PHONE]**, then dial the phone number.

 - The other line indicator lights.
- 3** To return to the 1st call, press the line button for the 1st call.
 - The 2nd call is disconnected.
 - To hold the 2nd call in step 3, press **[HOLD]** before pressing the line button for the 1st call.

Note:

- When the Do Not Disturb (DND) feature is turned on, beeps will not be heard during a conversation.
- To establish a conference call, see “Conference calls” on page 38.

Useful features during a call

Call privacy

Call privacy allows you to prevent other extensions from joining your conversations with outside callers. The phone always keeps call privacy on unless you manually turn this feature off.

Call privacy release

During the call, press the line button for the call. You will hear a double-beep.

- Any system phones can join the call by pressing the relevant line button.

Call privacy release recover

Press the line button again during the call. You will hear a 3-beep.

Note:

- Call privacy will turn on again automatically when you hang up.
- If a non-system phone is connected on the same line, this feature does not work for the phone.
- When a non-system phone answers a call, any system phones can join the call by pressing the relevant line button.

HOLD button

This feature allows you to put a call on hold (for an outside call only).

To put a call on hold

During an outside call, press **[HOLD]**.

- The line indicator flashes.
- If using the handset, you can place it on the cradle.
- To transfer the call to another extension, see “Transferring calls” on page 37.

To release the hold

Press the line button.

- The other extension users can take the call by pressing their line buttons.

Note:

- If a call is kept on hold for more than 60 or 120 seconds, an alarm tone starts to sound (hold reminder). To turn off the hold reminder, see “Hold reminder” on page 29.
- If a call is kept on hold for more than 5 minutes, the call is disconnected. To keep a call on hold longer than 5 minutes, release hold before 5 minutes and then place the call on hold again.

Hold reminder

This feature reminds you the call is on hold by sounding a 4-tone alarm every 60 or 120 seconds. The default setting is “60 Seconds”.

Important:

- Make sure that the unit is in standby mode.

- 1 Press **[MENU/SET]**.
 - 2 Select “Phone Setup”, then press **[MENU/SET]**.
 - 3 Select “Hold Reminder”, then press **[MENU/SET]**.
- Hold Reminder
 Handsfree Mode
 Prime Line
 [▼/▲]:Scroll
- 4 Select the desired setting, then press **[MENU/SET]**.

Hold Reminder
 = 60 Seconds
 [SET]:Save
 [▼/▲]:Change

- 5 Press and hold **[MENU/SET]** to return to standby mode.

Note:

- To return to the previous menu, press **[◀]**.

MUTE button

While mute is turned on, you can hear the other party, but the other party cannot hear you.

To mute your voice, press **[MUTE]**.

- The MUTE indicator lights.
- To return to the conversation, press **[MUTE]** again. The MUTE indicator goes out.
- When you switch between the handset and the speakerphone or press **[FLASH]**, mute will be released.

FLASH button

Pressing **[FLASH]** allows you to use special features of your host PBX such as transferring an extension call, or accessing optional telephone services such as Call Waiting.

Note:

- To change the flash time, see “Flash time” on page 30.

For Call Waiting service users

To use Call Waiting, you must subscribe to Call Waiting service of your telephone service provider.

This feature allows you to receive calls while you are already talking on the phone.

If you receive a call while on the phone, you will hear a Call Waiting tone.

Press **[FLASH]** to answer the 2nd call after the tone.

- To switch between calls, press **[FLASH]**.

Note:

- Please contact your telephone service provider for details and availability of this service in your area.

Flash time

The flash time depends on your telephone exchange or host PBX. You can select the following flash time: 80 ms, 100 ms, 200 ms, 300 ms, 400 ms, 500 ms, 600 ms, and 700 ms. The default setting is "600 ms".

Important:

- Make sure that the unit is in standby mode.

- 1 Press **[MENU/SET]**.
- 2 Select "Phone Setup", then press **[MENU/SET]**.
- 3 Select "Flash Time", then press **[MENU/SET]**.

```
→Flash Time
  Hold Reminder
  Handsfree Mode
  [▼/▲]:Scroll
```

- 4 Select the desired setting, then press **[MENU/SET]**.

```
Flash Time
=600 ms
[SET]:Save
[▼/▲]:Change
```

- 5 Press and hold **[MENU/SET]** to return to standby mode.

Note:

- To return to the previous menu, press **[◀]**.
- If you are connected via a PBX, a longer flash time may be necessary to use PBX functions (transferring a call, etc.). Consult your PBX installer for the correct setting.

Temporary tone dialing (for rotary/pulse service users)

You can temporarily switch the dialing mode to tone when you need to access touch tone services (for example, answering services, telephone banking services, etc.).

Press **[*]** (TONE) before entering access numbers which require tone dialing.

Speed dialer

You can store up to 32 names and phone numbers in the speed dial buttons. (16 names and numbers in upper memory locations, 16 names and numbers in lower memory locations.)

Speed dial preference

If you want to place speed dialer calls using only one button, set this feature to "CO Call". If you want to place intercom call using only one button, set this feature to "Intercom DSS". If you want to place speed dialer calls after reviewing the entries, set this feature to "Preview Memory".

Important:

- Make sure that the unit is in standby mode.

- 1 Press **[MENU/SET]**.
- 2 Select "Phone Setup", then press **[MENU/SET]**.
- 3 Select "Speed Dial", then press **[MENU/SET]**.

```
→Speed Dial
Language
Extension No.
[▼/▲]:Scroll
```

- 4 Select "SPD Preference", then press **[MENU/SET]**.

```
→SPD Preference
Edit/View SPD
[▼/▲]:Scroll
```

- 5 Select the desired setting, then press **[MENU/SET]**.

```
SPD Preference
=CO Call
[SET]:Save
[▼/▲]:Change
```

- 6 Press and hold **[MENU/SET]** to return to standby mode.

Note:

- To return to the previous menu, press **[◀]**.

Adding/editing names and phone numbers

Important:

- Make sure that the unit is in standby mode.

- 1 Press **[MENU/SET]**.
- 2 Select "Phone Setup", then press **[MENU/SET]**.
- 3 Select "Speed Dial", then press **[MENU/SET]**.

```
→Speed Dial
Language
Extension No.
[▼/▲]:Scroll
```

- 4 Select "Edit/View SPD", then press **[MENU/SET]**.

```
→Edit/View SPD
SPD Preference
[▼/▲]:Scroll
```

- 5 Press the speed dial button (**[1]** to **[16]**).

OR

Press **[LOWER]**, then press the speed dial button (**[1]** to **[16]**).

```
Edit/View SPD
```

```
Select SPD Key
```

- 6 Press **[MENU/SET]**.
- 7 Select "Edit", then press **[MENU/SET]**.

Speed Dialer

- 8** Enter (or edit) the name (max. 16 characters; see “Character table” on page 32).
- To erase the character, select “Delete Char”, then press **[MENU/SET]**.
- 9** Select “Done”, then press **[MENU/SET]**.
- To cancel, select “Cancel”, then press **[MENU/SET]**.
- 10** Enter (or edit) the phone number (max. 24 digits).
- To erase the number, select “Delete Char”, then press **[MENU/SET]**.
 - If required, you can insert **[FLASH]**, **[REDIAL/PAUSE]** or **[*]** (TONE) in a phone number.
 - To add the last number dialed, you can press **[REDIAL/PAUSE]** instead of entering the phone number.
- 11** Select “Done”, then press **[MENU/SET]**.
- To cancel, select “Cancel”, then press **[MENU/SET]**.
- 12** Press and hold **[MENU/SET]** to return to standby mode.

Note:

- To return to the previous menu, press **[◀]**.

Character table

Key	Character
[1]	, - ' & . () @ ! 1
[2]	A B C a b c 2
[3]	D E F d e f 3
[4]	G H I g h i 4
[5]	J K L j k l 5
[6]	M N O m n o 6
[7]	P Q R S p q r s 7
[8]	T U V t u v 8
[9]	W X Y Z w x y z 9
[0]	Space 0
[*]	*
[#]	#

- To enter another character that is located on the same dial key, first press **[▶]** to move the cursor to the next space.

Editing/correcting a mistake

Press **[◀]** or **[▶]** to move the cursor to the character or number you want to erase, select “Delete Char”, then press **[MENU/SET]**. Enter the appropriate character or number.

Storing items from the redial list into the speed dialer

Important:

- Make sure that the unit is in standby mode.

- 1** Press **[REDIAL/PAUSE]**.

- 2 Press [**▼**] or [**▲**] to select the desired number, then press [**MENU/SET**].
- 3 Select "Copy To SPD", then press [**MENU/SET**].
- 4 Press the speed dial button ([**1**] to [**16**]).
OR
Press [**LOWER**], then press the speed dial button ([**1**] to [**16**]).

3215555

Select SPD Key

- 5 Enter the name (max. 16 characters; see "Character table" on page 32).
 - To erase the character, select "Delete Char", then press [**MENU/SET**].
- 6 Select "Done", then press [**MENU/SET**].
 - To cancel, select "Cancel", then press [**MENU/SET**].
- 7 Edit the phone number if necessary.
 - To erase the number, select "Delete Char", then press [**MENU/SET**].
 - If required, you can insert [**FLASH**], [**REDIAL/PAUSE**] or [*****] (TONE) in a phone number.
- 8 Select "Done", then press [**MENU/SET**].
 - To cancel, select "Cancel", then press [**MENU/SET**].
- 9 Press [**REDIAL/PAUSE**] to return to standby mode.

Note:

- To return to the previous menu, press [**◀**].

Erasing a stored entry

Important:

- Make sure that the unit is in standby mode.

- 1 Press [**MENU/SET**].
- 2 Select "Phone Setup", then press [**MENU/SET**].
- 3 Select "Speed Dial", then press [**MENU/SET**].

→Speed Dial
Language
Extension No.
[**▼/▲**]:Scroll

- 4 Select "Edit/View SPD", then press [**MENU/SET**].

→Edit/View SPD
SPD Preference
[**▼/▲**]:Scroll

- 5 Press the speed dial button ([**1**] to [**16**]).
OR
Press [**LOWER**], then press the speed dial button ([**1**] to [**16**]).

Edit/View SPD

Select SPD Key

- 6 Press [**MENU/SET**].
- 7 Select "Erase", then press [**MENU/SET**].
 - To cancel, select "Cancel", then press [**MENU/SET**].
- 8 Press and hold [**MENU/SET**] to return to standby mode.

Note:

- To return to the previous menu, press [**◀**].

Calling someone with the speed dialer

If speed dial preference is set to

“CO Call”

Press the desired speed dial button ([1] to [16]).

OR

Press [LOWER], then press the desired speed dial button ([1] to [16]).

If speed dial preference is set to

“Intercom DSS”

- 1 Lift the handset or press [SP-PHONE] or a line button.
- 2 Press the desired speed dial button ([1] to [16]).
OR
Press [LOWER], then press the desired speed dial button ([1] to [16]).

If speed dial preference is set to

“Preview Memory”

- 1 Press the desired speed dial button ([1] to [16]).
OR
Press [LOWER], then press the desired speed dial button ([1] to [16]).
 - You can review the entries by pressing [▼] or [▲].
- 2 Lift the handset or press [SP-PHONE] or a line button.

Intercom/Paging

A 2-way intercom can be set up between two extensions. Make sure that each extension has been assigned the number (“11” to “26”, see “Extension No.” on page 23) and is connected to the LINE1/2 and LINE3/4 telephone jacks of the unit (page 15, 16, 17).

The speed dial (extension) buttons “1, 2, 3...15, 16” mean the extension numbers “11, 12, 13...25, 26”.

Note:

- If you press the line button during an intercom call (paging), the intercom call (paging) is disconnected and you can make or answer an outside call.

Making an intercom call

Using the handset

- 1 Press **[INTERCOM]**.
 - The INTERCOM indicator lights.
 - The SP-PHONE indicator lights and the speakerphone turns on.
- 2 Lift the handset.
 - The SP-PHONE indicator goes out.
- 3 Press the speed dial (extension) button or enter the extension number.
- 4 To end the intercom call, place the handset on the cradle.
 - The INTERCOM indicator goes out.

Using the speakerphone

- 1 Press **[INTERCOM]**.
 - The INTERCOM indicator lights.
 - The SP-PHONE indicator lights and the speakerphone turns on.

- 2 Press the speed dial (extension) button or enter the extension number.

- 3 To end the intercom call, press **[SP-PHONE]** or **[INTERCOM]**.
 - The INTERCOM and the SP-PHONE indicators go out.

If speed dial preference is set to “Intercom DSS”

- 1 Press the speed dial (extension) button.
 - The INTERCOM indicator lights.
 - The SP-PHONE indicator lights and the speakerphone turns on.
- 2 To end the intercom call, press **[SP-PHONE]** or **[INTERCOM]**.
 - The INTERCOM and the SP-PHONE indicators go out.

Answering an intercom call

The INTERCOM indicator flashes rapidly and the extension number of the caller is displayed.

Lift the handset or press **[SP-PHONE]** or **[INTERCOM]**.

Answering an intercom call directed to another extension

Any extensions can answer the intercom call directed to another extension.

Press **[INTERCOM]**.

Paging a designated extension

Important:

- Turn Do Not Disturb (DND) off at the destination extension (see “Turning Do Not Disturb (DND) on/off” on page 27).

1 Press **[INTERCOM]** 2 times.

- The INTERCOM indicator lights.
- The SP-PHONE indicator lights and the speakerphone turns on.

2 Press the speed dial (extension) button or enter the extension number, then speak into the MIC or the handset.

- The destination extension does not ring, instead it will beep 3 times.
- You can make an intercom call by pressing **[INTERCOM]**.

3 To end the paging, place the handset on the cradle or press **[SP-PHONE]**.

Answering a single page

If auto mute is set to on

Lift the handset or press **[MUTE]**.

If auto mute is set to off

Speak into the MIC or the handset.

Turning auto mute on/off

If this feature is set to off, sounds at the paged extension is heard automatically.

Important:

- Make sure that the unit is in standby mode.

1 Press **[MENU/SET]**.

2 Select “Phone Setup”, then press **[MENU/SET]**.

3 Select “Auto Mute”, then press **[MENU/SET]**.

→Auto Mute
Tone/Pulse
Flash Time
[▼/▲]: Scroll

4 Select the desired setting, then press **[MENU/SET]**.

Auto Mute
=On
[SET]: Save
[▼/▲]: Change

5 Press and hold **[MENU/SET]** to return to standby mode.

Note:

- To return to the previous menu, press **[◀]**.

Paging all extensions

Important:

- Turn Do Not Disturb (DND) off at the destination extension (see “Turning Do Not Disturb (DND) on/off” on page 27).

1 Press **[INTERCOM]**.

- The INTERCOM indicator lights.
- The SP-PHONE indicator lights and the speakerphone turns on.

2 Press **[0]** to page all extensions, then speak into the MIC or the handset.

- The other extensions will hear your paging voice through the speaker.

3 To end the paging, place the handset on the cradle or press **[SP-PHONE]** or **[INTERCOM]**.

Note:

- You can only talk with an extension who answers first.

Answering all pages

Press **[INTERCOM]**.

Room monitor

You can monitor a room using the intercom feature. For example, you can monitor a baby from different areas of the house.

To use this feature, turn auto mute off at the destination extension.

Important:

- Turn auto mute off at the destination extension (see “Turning auto mute on/off” on page 36).
- Make sure that the destination unit is in standby mode.

- 1 Press **[INTERCOM]** 2 times.
 - The INTERCOM indicator lights.
 - The SP-PHONE indicator lights and the speakerphone turns on.
- 2 Press the speed dial (extension) button or enter the extension number.
 - The destination extension does not ring, instead it will beep 3 times.
 - Your unit starts to monitor the room through the extension.
 - If necessary, you can mute your sound output by pressing **[MUTE]**.
- 3 To end monitoring, press **[SP-PHONE]** or place the handset on the cradle.

Note:

- To avoid being monitored and keep privacy, turn Do Not Disturb (DND) on.
- The monitored extension user can stop being monitored by pressing **[SP-PHONE]** or **[INTERCOM]**.

Transferring calls

You can transfer an outside call to another extension.

The speed dial (extension) buttons “1, 2, 3...15, 16” mean the extension numbers “11, 12, 13...25, 26”.

Blind transfer

- 1 During an outside call, press **[TRANSFER]** to put the call on hold.
- 2 Press the speed dial (extension) button or enter the extension number, then place the handset on the cradle.
 - If the transferred extension does not answer within 1 minute, the transferred call will ring at all extensions.

Note:

- Any extensions can take a transferred call by pressing the relevant line button.
- If a call is kept on hold for more than 60 or 120 seconds, an alarm tone starts to sound (hold reminder). To turn off the hold reminder, see “Hold reminder” on page 29.
- If a call is kept on hold for more than 5 minutes, the call is disconnected.

Paging before transfer

- 1 During an outside call, press **[INTERCOM]** 2 times to put the call on hold.
 - You can make an intercom call by pressing **[INTERCOM]**.
- 2 Press the speed dial (extension) button or enter the extension number.
 - If the paged extension does not answer, press the relevant line button.

- 3 After the paged extension answers, announce the transfer.
- 4 Press **[TRANSFER]**, then place the handset on the cradle.
 - If the transferred extension does not answer within 1 minute, the transferred call will ring at all extensions.

Note:

- Any extensions can take a transferred call by pressing the relevant line button.
- To page all extensions in step 2, press **[0]**.
- If a call is kept on hold for more than 60 or 120 seconds, an alarm tone starts to sound (hold reminder). To turn off the hold reminder, see "Hold reminder" on page 29.
- If a call is kept on hold for more than 5 minutes, the call is disconnected.

Answering transferred calls

The line indicator flashes rapidly and the extension number of the caller is displayed.

Lift the handset or press **[SP-PHONE]** or a line button.

Answering a transferred call directed to another extension

Any extensions can answer a transferred call directed to another extension.

Press the relevant line button.

Conference calls

Conference call with two outside calls

While you are talking with an outside caller, you can make or answer a 2nd call on the other line, and then combine the calls to establish a conference call.

- 1 During an outside call, press **[HOLD]**.
- 2 To answer a 2nd call, press the relevant line button.
To make a 2nd call, press the other line button or **[SP-PHONE]**, then dial the phone number.
- 3 When the 2nd call is connected, press **[CONFERENCE]** to make a conference call.
 - To hang up both lines, place the handset on the cradle or press **[SP-PHONE]**.
 - To hang up only one line, press the line button for the party with which you want to continue talking.
 - To put both lines on hold, press **[HOLD]**.
 - To talk with only one caller, press the line button for the party with which you want to continue talking.
 - To resume both lines, press the relevant line button, then press **[CONFERENCE]**.

Note:

- If a call is kept on hold for more than 60 or 120 seconds, an alarm tone starts to sound (hold reminder). To turn off the hold reminder, see "Hold reminder" on page 29.
- If a call is kept on hold for more than 5 minutes, the call is disconnected.

Conference with an outside call and an intercom call

While you are talking with an outside caller, one more extension can join the conversation and establish a conference call.

- 1** During an outside call, press **[INTERCOM]** to put the call on hold.
- 2** To page another extension, press the speed dial (extension) button or enter the extension number.
- 3** When the paged party answers, press **[CONFERENCE]** to make a conference call.
 - To hang up both the outside and intercom calls, place the handset on the cradle or press **[SP-PHONE]**. (The other remaining parties on the line can still talk.)

Note:

- If a call is kept on hold for more than 60 or 120 seconds, an alarm tone starts to sound (hold reminder). To turn off the hold reminder, see "Hold reminder" on page 29.
- If a call is kept on hold for more than 5 minutes, the call is disconnected.

Programmable settings

You can customize the unit by programming the following features. Make sure that the unit is in standby mode.

Note:

- In the following table, * shows the default setting.
- To return to the previous menu, press [◀].
- You can exit feature setup and return to the idle status any time by pressing and holding [MENU/SET].

Phone Setup

Sub-menu 1	Sub-menu 2	Setting	Page
Speed Dial	SPD Preference	CO Call*, Intercom DSS, Preview Memory	31
	Edit/View SPD	—	31
Language	—	English*, Español	23
Extension No.	—	11* – 26	23
Date & Time	—	2006 12/31 12:00A*	24
Auto Mute	—	On*, Off	36
Tone/Pulse	—	Tone*, Pulse	24
Flash Time	—	80 ms, 100 ms, 200 ms, 300 ms, 400 ms, 500 ms, 600 ms*, 700 ms	30
Hold Reminder	—	60 Seconds*, 120 Seconds, Off	29
Handsfree Mode	—	Headset*, Speakerphone	42
Prime Line	—	Line1*, Line2, Line3, Line4	42

Advanced Setup

Sub-menu 1	Sub-menu 2	Setting	Page
Ringer On/Off	Line1 Ringer	On*, Off	26
	Line2 Ringer	On*, Off	
	Line3 Ringer	On*, Off	
	Line4 Ringer	On*, Off	
Ringer Type	Line1 Ring Type	Type-1*, Type-2, Type-3, Type-4	27
	Line2 Ring Type	Type-1*, Type-2, Type-3, Type-4	
	Line3 Ring Type	Type-1*, Type-2, Type-3, Type-4	
	Line4 Ring Type	Type-1*, Type-2, Type-3, Type-4	
Line Group	-	Line 04* - 15, Private Line	43
Reset All	-	Yes, No	43

Programming the phone setup features

Prime line

If the selected line is ringing or all lines are idle, it has the highest priority to be picked up when you lift the handset or press **[SP-PHONE]**.

Important:

- Make sure that the unit is in standby mode.

- 1 Press **[MENU/SET]**.
- 2 Select "Phone Setup", then press **[MENU/SET]**.
- 3 Select "Prime Line", then press **[MENU/SET]**.

```
→Prime Line
  Speed Dial
  Language
  [▼/▲]:Scroll
```

- 4 Select the desired setting, then press **[MENU/SET]**.

```
Prime Line
=Line1
[SET]:Save
[▼/▲]:Change
```

- 5 Press and hold **[MENU/SET]** to return to standby mode.

Note:

- To return to the previous menu, press **[◀]**.

Handsfree mode

You can use this phone in "Handsfree" mode by using the speakerphone on the unit or a headset (optional).

This feature specifies a mode to be automatically selected each time you press a line key with the handset on the cradle.

Important:

- Make sure that the unit is in standby mode.

- 1 Press **[MENU/SET]**.
- 2 Select "Phone Setup", then press **[MENU/SET]**.
- 3 Select "Handsfree Mode", then press **[MENU/SET]**.

```
→Handsfree Mode
  Prime Line
  Speed Dial
  [▼/▲]:Scroll
```

- 4 Select the desired setting, then press **[MENU/SET]**.

```
Handsfree Mode
=Headset
[SET]:Save
[▼/▲]:Change
```

- 5 Press and hold **[MENU/SET]** to return to standby mode.

Note:

- To return to the previous menu, press **[◀]**.
- If you set "Handsfree" mode to "Headset" but do not actually have a headset connected, speakerphone will be used.

Programming the advanced setup features

Line group

You can choose to leave LINE4 unconnected at particular extensions or to connect private lines (constructing a line group) at particular extensions. To set up the line group, see "Setting up the line group" on page 20.

Important:

- Make sure that the unit is in standby mode.

- 1 Press **[MENU/SET]**.
- 2 Select "Advanced Setup", then press **[MENU/SET]**.
- 3 Select "Line Group", then press **[MENU/SET]**.

```

→Line Group
Reset All
Ringer On/Off
[▼/▲]:Scroll
  
```

- 4 Select the desired setting, then press **[MENU/SET]**.

```

Line Group
=Line 04
[SET]:Save
[▼/▲]:Change
  
```

- 5 Press and hold **[MENU/SET]** to return to standby mode.

Note:

- To return to the previous menu, press **[◀]**.
- Transferring a call to a different line group through line 4 is not allowed.

Reset all

Return all features to default settings, and all numbers set to speed dial are erased. You cannot undo the "Reset All" command.

Important:

- Make sure that the unit is in standby mode.

- 1 Press **[MENU/SET]**.
- 2 Select "Advanced Setup", then press **[MENU/SET]**.
- 3 Select "Reset All", then press **[MENU/SET]**.

```

→Reset All
Ringer On/Off
Ringer Type
[▼/▲]:Scroll
  
```

- 4 Select "Yes?", then press **[MENU/SET]**.

```

Reset All
Yes?
[SET]:Reset
[▼/▲]:Change
  
```

- To cancel, select "No?", then press **[MENU/SET]**.
- 5 Press and hold **[MENU/SET]** to return to standby mode.

Note:

- To return to the previous menu, press **[◀]**.

Headset (optional)

Sales and support information

- To order replacement accessories, call 1-800-332-5368.
- TTY users (hearing or speech impaired users) can call 1-866-605-1277.

Connecting the optional headset to the unit

Connecting a headset to the unit allows hands-free phone conversations. We recommend using the Panasonic headset noted on page 5.



- Headset shown is KX-TCA88HA.

Making/Answering calls

- 1 Press **[HEADSET]** to make or answer a call.
 - If you misdial when making a call, press **[HEADSET]** and start again from step 1.
- 2 To hang up, press **[HEADSET]**.

To adjust the headset receiver volume (5 levels)

While using the headset, press **[−]** or **[+]**.

Switching between headset, handset, and speakerphone

Switching from handset to headset

Press **[HEADSET]**, then place the handset on the cradle.

Switching from headset to handset

When the handset is on the cradle, lift the handset.

When the handset is off-hook, press **[HEADSET]** again.

Switching from headset to speakerphone

Press **[SP-PHONE]**.

Switching from speakerphone to headset

Press **[HEADSET]**.

Note:

- If you unplug the headset while the phone is in use, the phone will not automatically switch to speakerphone. You must press **[SP-PHONE]** to switch.

Wall mounting

This unit can be mounted on a wall phone plate.

- 1 Pull down the handset hook until it locks, **so the tab holds the handset.**

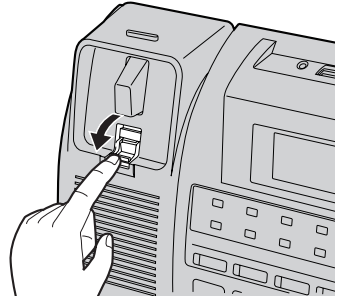

- 2 Connect the AC adaptor, and dress the AC adaptor cord as shown.

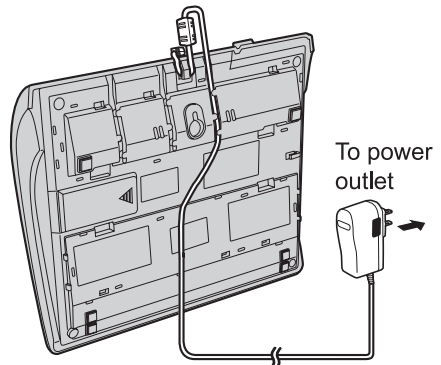

- 3 Dress the telephone line cord as shown. Tuck the telephone line cord inside the wall mounting adaptor, then push it in the direction of the arrows (1 and 2).

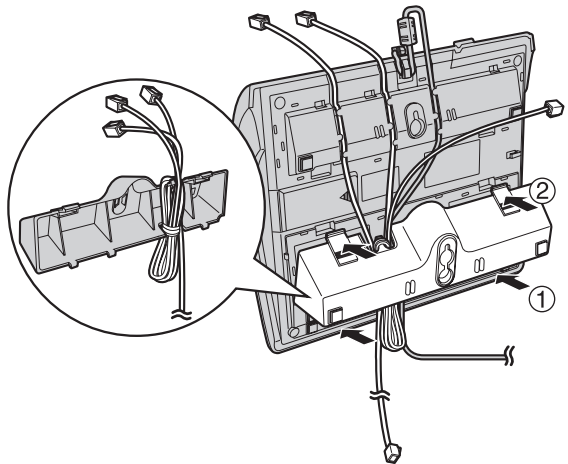

Useful Information

- 4** Connect the telephone line cord.
Mount the unit, then slide down.

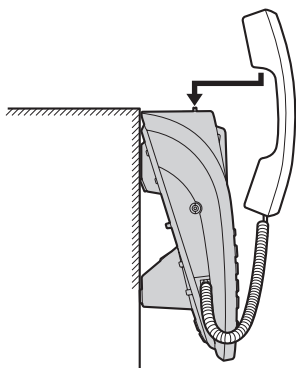
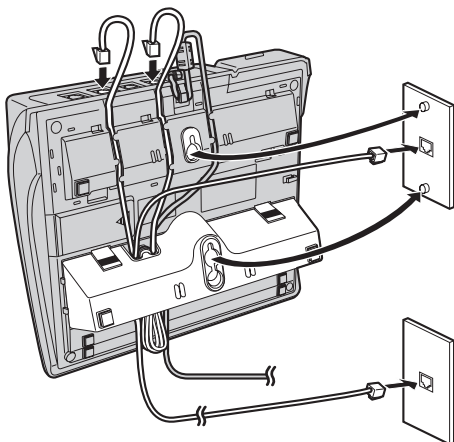

To temporarily set the handset down during a conversation, place it as shown here.

Connecting a standard telephone

If the backup battery has been discharged during a power failure, the unit will not work. If required, you can connect a standard telephone on LINE 2 or LINE 4 of this unit using the Panasonic T-adaptor KX-J66. To order, call the accessories telephone number on page 5.

Example: Connecting a standard telephone on LINE 4.

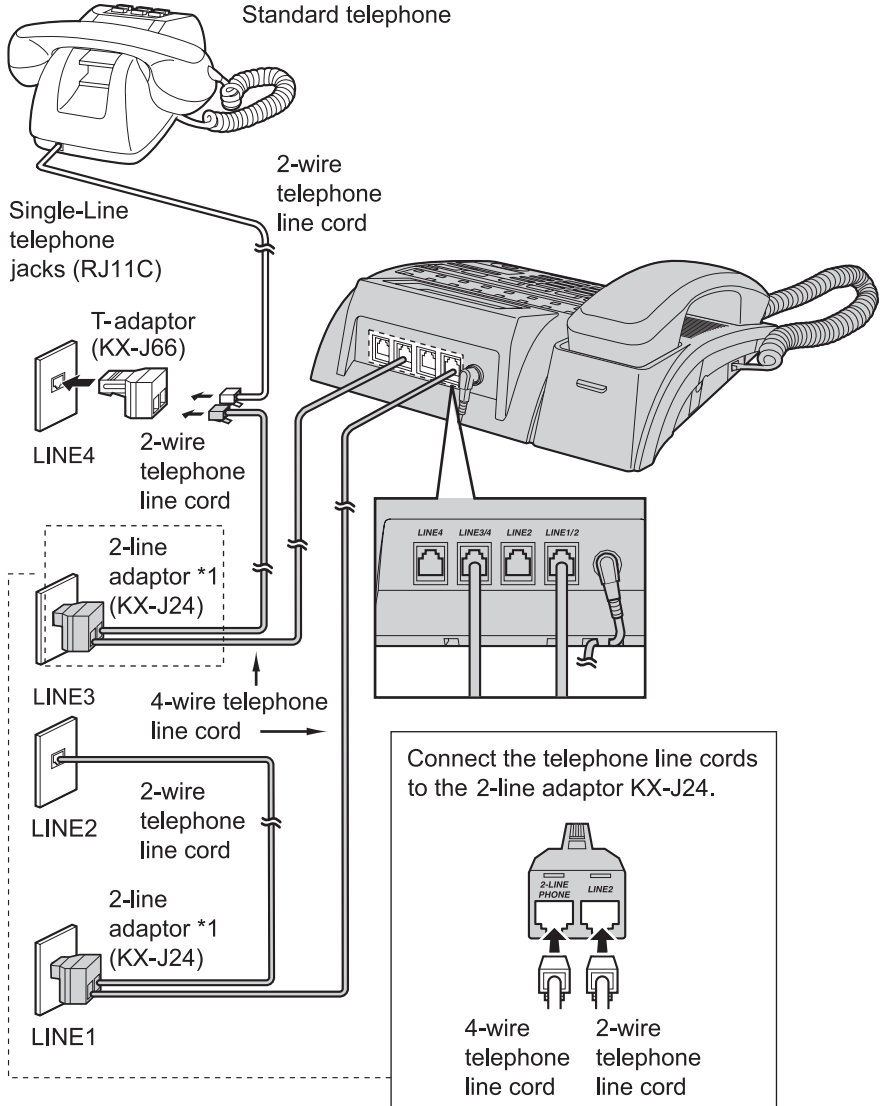

*1 2-line adaptor merges a 2-wire (single line) telephone outlet with another 2-wire (single line) telephone line onto a single 4-wire (2-line) telephone line cord.

Error messages

If the unit detects a problem, one of the following messages is shown on the display.

Display message	Cause/solution
LOW BATT	<ul style="list-style-type: none">● No battery is installed.● The battery may need to be replaced with a new one (see “Battery replacement” on page 12).
PowerFail	<ul style="list-style-type: none">● When the phone is disconnected from a power outlet or there is a power failure, the battery works as emergency power. When power is restored, “PowerFail” will disappear on the display.

Troubleshooting

General use

Problem	Cause/solution
The unit does not work.	<ul style="list-style-type: none"> ● Check the connections (page 14, 15, 16, 17). ● Unplug the AC adaptor to reset the unit. Reconnect the adaptor and try again.
The line indicators do not work properly.	<ul style="list-style-type: none"> ● Check the connections (page 14, 15, 16, 17).
The unit does not ring.	<ul style="list-style-type: none"> ● The ringer is set to "OFF". Turn it on (see "Turning ringer on/off" on page 26). ● The Do Not Disturb (DND) feature is turned on. Turn it off (see "Turning Do Not Disturb (DND) on/off" on page 27). ● If there are several non-system phones on the line that do not ring, disconnect some of them. Having too many phones connected can also result in low ringer volumes on non-system phones.
You cannot hear a dial tone.	<ul style="list-style-type: none"> ● Check the connections (see "Connecting the handset and AC adaptor" on page 14). ● Confirm the telephone line cord is properly connected (page 15, 16, 17). ● Disconnect the unit from the telephone line and connect a known working telephone. If the working telephone operates properly, contact our service personnel to have the unit repaired. If the working telephone does not operate properly, contact your telephone service provider.
Date and time on the display flashes.	<ul style="list-style-type: none"> ● Set the date and time (see "Date and time" on page 24).
You cannot dial.	<ul style="list-style-type: none"> ● Check whether the dialing mode selection is correct (see "Dialing mode" on page 24).
The battery is discharged.	<ul style="list-style-type: none"> ● Please remove the battery when you cut the power supply, as the battery will discharge automatically once the power is cut according to the time shown on page 12.
How do I return to standby mode quickly?	<ul style="list-style-type: none"> ● Lift the handset, then place it back on the cradle. ● Press [SP-PHONE] 2 times.

Useful Information

Programmable settings

Problem	Cause/solution
You cannot program function items, such as the dialing mode.	<ul style="list-style-type: none">● Programming is not possible while in the talk or intercom mode.● Do not pause for over 30 seconds while programming.● Make sure that the unit is in standby mode.

Making/answering calls, intercom

Problem	Cause/solution
Static is heard, sound cuts in and out.	<ul style="list-style-type: none">● If your unit is connected to a telephone line with DSL service, we recommend connecting a noise filter between the unit and the telephone line jack (see “Connecting 2 two-line telephone jacks” on page 18, “Connecting four single-line telephone jacks” on page 19). Contact your DSL provider for details.
You cannot redial the last number dialed.	<ul style="list-style-type: none">● If the last number dialed was more than 32 digits long, the number cannot be redialed.● Access numbers entered after pressing [*] (TONE) will not be included when redialing.
You cannot have a conversation using the headset.	<ul style="list-style-type: none">● Make sure that [HEADSET] is pressed.● Make sure that the headset is plugged into the headset jack properly (see “Connecting the optional headset to the unit” on page 44).
During a power failure, you cannot make or answer a call.	<ul style="list-style-type: none">● Make sure that a battery has been installed properly (see “Battery installation” on page 12).● The battery may have been discharged. In that case, replace the battery with a new one (see “Battery replacement” on page 12).
The intercom does not work.	<ul style="list-style-type: none">● DSL Internet connection and KX-TS4100/KX-TS4200/KX-TS4300 Intercom work at similar frequencies. Please contact Panasonic at 1-800-211-PANA (1-800-211-7262) for special wiring configurations.
You cannot page other extension.	<ul style="list-style-type: none">● The unit is in use. Try again later.
You cannot answer the transferred call even if the display shows “Transfer From xx”.	<ul style="list-style-type: none">● The transferred call was disconnected before you answered it.

FCC and other information

This equipment complies with Part 68 of the FCC rules and the requirements adopted by the ACTA. On the bottom of this equipment is a label that contains, among other information, a product identifier in the format US:ACJ-----. If requested, this number must be provided to the telephone company.

- Registration No.
.....(found on the bottom of the unit)
- Facility Interface Code.....02LS2
- Service Order Code.....9.0F
- Required Network Interface Jack
.....RJ11C, RJ14C
- Ringer Equivalence No.
(REN).....0.3B

A plug and jack used to connect this equipment to the premises wiring and telephone network must comply with the applicable FCC Part 68 rules and requirements adopted by the ACTA. A compliant telephone cord and modular plug is provided with the product. It is designed to be connected to a compatible modular jack that is also compliant.

The REN is used to determine the number of devices that may be connected to a telephone line. Excessive RENs on a telephone line may result in the devices not ringing in response to an incoming call. In most but not all areas, the sum of RENs should not exceed five (5.0). To be certain of the number of devices that may be connected to a line, as determined by the total RENs, contact the local telephone company. For products approved after July 23, 2001, the REN for the product is part of the product identifier that has the format US:AAAEQ##TXXXX. The digits

represented by ## are the REN without a decimal point (e.g., 03 is a REN of 0.3).

If this equipment causes harm to the telephone network, the telephone company will notify you in advance that temporary discontinuance of service may be required. But if advance notice isn't practical, the telephone company will notify the customer as soon as possible. Also, you will be advised of your right to file a complaint with the FCC if you believe it is necessary.

The telephone company may make changes in its facilities, equipment, operations or procedures that could affect the operation of the equipment. If this happens the telephone company will provide advance notice in order for you to make necessary modifications to maintain uninterrupted service.

If trouble is experienced with this equipment, for repair or warranty information, please contact a Factory Servicenter or other Authorized Servicer. If the equipment is causing harm to the telephone network, the telephone company may request that you disconnect the equipment until the problem is resolved.

Connection to party line service is subject to state tariffs. Contact the state public utility commission, public service commission or corporation commission for information.

If your home has specially wired alarm equipment connected to the telephone line, ensure the installation of this equipment does not disable your alarm equipment. If you have questions about what will disable alarm equipment, consult your telephone company or a qualified installer.

Useful Information

This equipment is hearing aid compatible as defined by the FCC in 47 CFR Section 68.316.

WHEN PROGRAMMING EMERGENCY NUMBERS AND(OR) MAKING TEST CALLS TO EMERGENCY NUMBERS:

- 1) Remain on the line and briefly explain to the dispatcher the reason for the call.
- 2) Perform such activities in the off-peak hours, such as early morning or late evenings.

This device complies with Part 15 of the FCC Rules. Operation is subject to the following two conditions:

(1) This device may not cause harmful interference, and (2) this device must accept any interference received, including interference that may cause undesired operation.

CAUTION:

Any changes or modifications not expressly approved by the party responsible for compliance could void the user's authority to operate this device.

NOTE:

This equipment has been tested and found to comply with the limits for a Class B digital device, pursuant to Part 15 of the FCC Rules. These limits are designed to provide reasonable protection against harmful interference in a residential installation. This equipment generates, uses, and can radiate radio frequency energy and, if not installed and used in accordance with the instructions, may cause harmful interference to radio communications. However, there is no guarantee that interference will not occur in a particular installation. If this equipment does cause harmful interference to radio or television reception, which can be

determined by turning the equipment off and on, the user is encouraged to try to correct the interference by one or more of the following measures:

- Reorient or relocate the receiving antenna.
- Increase the separation between the equipment and receiver.
- Connect the equipment into an outlet on a circuit different from that to which the receiver is connected.
- Consult the dealer or an experienced radio/TV technician for help.

Specifications

Operating environment	5 °C – 40 °C (41 °F – 104 °F)
Dimensions (without wall mounting adaptor)	Approx. height 105 mm x width 245 mm x depth 225 mm (4 ¹ / ₈ inches x 9 ²¹ / ₃₂ inches x 8 ⁷ / ₈ inches)
Mass (Weight) (without wall mounting adaptor)	Approx. 1,050 g (2.32 lb.)
Power consumption	Standby: Approx. 5 W (PQLV210Z) Maximum: Approx. 8 W (PQLV210Z)
Power supply	AC adaptor (120 V AC, 60 Hz)

Note:

- Design and specifications are subject to change without notice.
- The illustrations in these instructions may vary slightly from the actual product.

Customer services

Customer Services Directory

Obtain Product Information and Operating Assistance; locate your nearest Dealer or Servicenter; purchase Parts and Accessories; or make Customer Service and Literature requests by visiting our Web Site at:

<http://www.panasonic.com/consumersupport>

or, contact us via the web at:

<http://www.panasonic.com/contactinfo>

You may also contact us directly at: 1-800-211-PANA (1-800-211-7262),
Monday-Friday 9 am-9 pm; Saturday-Sunday 10 am-7 pm, EST.

TTY users (hearing or speech impaired users) can call 1-877-833-8855.

Accessory Purchases

Purchase Parts, Accessories and Instruction Books online for all Panasonic Products by visiting our Web Site at:

<http://www.pasc.panasonic.com>

or, send your request by E-mail to:

npcparts@us.panasonic.com

You may also contact us directly at:

1-800-332-5368 (Phone) 1-800-237-9080 (Fax Only)

(Monday - Friday 9 am to 9 pm, EST.)

Panasonic Services Company

20421 84th Avenue South, Kent, WA 98032

(We Accept Visa, MasterCard, Discover Card, American Express, and Personal Checks)

TTY users (hearing or speech impaired users) can call 1-866-605-1277.

Service in Puerto Rico

Panasonic Puerto Rico, Inc.

San Gabriel Industrial Park, Ave. 65 de Infantería, Km. 9.5,

Carolina, Puerto Rico 00985

Phone (787)750-4300, Fax (787)768-2910

Warranty

PANASONIC CONSUMER
ELECTRONICS COMPANY, DIVISION
OF PANASONIC CORPORATION OF
NORTH AMERICA
One Panasonic Way,
Secaucus, New Jersey 07094

PANASONIC PUERTO RICO, INC.
San Gabriel Industrial Park,
Ave. 65 de Infantería, Km. 9.5,
Carolina, Puerto Rico 00985

Panasonic Telephone Products Limited Warranty

Limited Warranty Coverage

If your product does not work properly because of a defect in materials or workmanship, Panasonic Consumer Electronics Company or Panasonic Puerto Rico, Inc. (collectively referred to as "the warrantor") will, for the length of the period indicated on the chart below, which starts with the date of original purchase ("Limited Warranty period"), at its option either (a) repair your product with new or refurbished parts, or (b) replace it with a new or a refurbished product. The decision to repair or replace will be made by the warrantor.

Parts	Labor
One (1) Year	One (1) Year

During the "Labor" Limited Warranty period there will be no charge for labor. During the "Parts" Limited Warranty period, there will be no charge for parts. You must mail-in your product prepaid during the Limited Warranty period. This Limited Warranty excludes both parts and labor for batteries, antennas, and cosmetic parts (cabinet). This Limited Warranty only applies to products purchased and serviced in the United States or Puerto Rico. This Limited Warranty is extended only to the original purchaser and only covers products purchased as new.

Mail-In Service

For assistance in the continental U.S.A. in obtaining repairs please ship the product prepaid to:

Panasonic Services Company Customer Servicenter

4900 George McVay Drive Suite B Door #12 McAllen, TX 78503

For assistance in Puerto Rico call Panasonic Puerto Rico, Inc. (787)-750-4300 or fax (787)-768-2910.

When shipping the unit carefully pack, include all accessories, and send it prepaid, adequately insured and preferably in the original carton. Include a letter detailing the complaint and provide a day time phone number where you can be reached.

IF REPAIR IS NEEDED DURING THE LIMITED WARRANTY PERIOD THE PURCHASER WILL BE REQUIRED TO FURNISH A SALES RECEIPT/PROOF OF PURCHASE INDICATING DATE OF PURCHASE, AMOUNT PAID AND PLACE OF PURCHASE. CUSTOMER WILL BE CHARGED FOR THE REPAIR OF ANY UNIT RECEIVED WITHOUT SUCH PROOF OF PURCHASE.

Limited Warranty Limits And Exclusions

This Limited Warranty ONLY COVERS failures due to defects in materials or workmanship, and DOES NOT COVER normal wear and tear or cosmetic damage. The Limited Warranty ALSO DOES NOT COVER damages which occurred in shipment, or failures which are caused by products not supplied by the warrantor, or failures which result from accidents, misuse, abuse, neglect, bug infestation, mishandling, misapplication, alteration, faulty installation, set-up adjustments, misadjustment of consumer controls, improper maintenance, power line surge, lightning damage, modification, introduction of sand, humidity or liquids, or rental use of the product, or service by anyone other than a Factory Servicenter or other Authorized Servicer, or damage that is attributable to acts of God.

THERE ARE NO EXPRESS WARRANTIES EXCEPT AS LISTED UNDER "LIMITED WARRANTY COVERAGE". THE WARRANTOR IS NOT LIABLE FOR INCIDENTAL OR CONSEQUENTIAL DAMAGES RESULTING FROM THE USE OF THIS PRODUCT, OR ARISING OUT OF ANY BREACH OF THIS LIMITED WARRANTY. (As examples, this excludes damages for lost time, lost calls or messages, cost of having someone remove or re-install an installed unit if applicable, travel to and from the servicer. The items listed are not exclusive, but are for illustration only.) **ALL EXPRESS AND IMPLIED WARRANTIES, INCLUDING THE WARRANTY OF MERCHANTABILITY, ARE LIMITED TO THE PERIOD OF THE LIMITED WARRANTY.**

Some states do not allow the exclusion or limitation of incidental or consequential damages, or limitations on how long an implied warranty lasts, so the exclusions may not apply to you.

This Limited Warranty gives you specific legal rights and you may also have other rights which vary from state to state. If a problem with this product develops during or after the Limited Warranty period, you may contact your dealer or Servicenter. If the problem is not handled to your satisfaction, then write to the warrantor's Consumer Affairs Department at the addresses listed for the warrantor.

PARTS AND SERVICE, WHICH ARE NOT COVERED BY THIS LIMITED WARRANTY, ARE YOUR RESPONSIBILITY.

Index

- A** Answering calls: 26
Auto mute: 36
- B** Battery
 - Installation: 12
 - Life: 12
 - Replacement: 12
- C** Call privacy: 28
Call Waiting: 29
Conference calls: 38
Connections
 - Communication device: 22
 - Handset and AC adaptor: 14
 - Noise filter: 18, 19
 - Standard telephone: 47
 - Telephone line cords: 15, 16, 17
- D** Date and time: 24
Dialing mode: 24
Display language: 23
Do Not Disturb (DND): 27
- E** Error messages: 48
Extension No.: 23
- F** Flash: 29
Flash time: 30
- H** Headset, optional: 44
Hold: 28
Hold reminder: 29
- I** Intercom: 35
- L** Line group: 20, 43
- M** Making calls: 25
Memory card: 11
Mute: 29
- N** Navigator key: 10
- P** Page: 36
Pause: 26
Power failure: 14
Prime line: 42
Pulse service: 30
- R** Redial list: 25
Reset all: 43
Ringer on/off: 26
Ringer type: 27
Room monitor: 37
Rotary service: 30
- S** Speed dial preference: 31
Speed dialer: 31
- SP-phone: 25
- T** Tone service: 30
Transferring calls: 37
Troubleshooting: 49
TTY: 5, 60
- V** Volume
 - Handset: 25
 - Headset: 44
 - Ringer: 26
 - Speaker: 25
- W** Wall mounting: 45
Warranty: 55

Notes

Notes

If you need assistance with setup or operation

- 1** Visit our website: <http://www.panasonic.com/phonehelp>
- 2** Contact us via the web at: <http://www.panasonic.com/contactinfo>
- 3** Call us at: 1-800-211-PANA (1-800-211-7262)
TTY users (hearing or speech impaired users) can call 1-877-833-8855.

When you ship the product

- Carefully pack your unit, preferably in the original carton.
- Attach a letter, detailing the symptom, to the outside of the carton.
- Send the unit to Panasonic Services Company Customer Servicenter, prepaid and adequately insured.
- Do not send your unit to Panasonic Consumer Electronics Company listed below or to executive or regional sales offices. These locations do not repair consumer products.

**Panasonic Consumer Electronics Company,
Division of Panasonic Corporation of North America**
One Panasonic Way, Secaucus, New Jersey 07094

Panasonic Puerto Rico, Inc.
San Gabriel Industrial Park, Ave. 65 de Infantería, Km. 9.5,
Carolina, Puerto Rico 00985

Copyright:

This material is copyrighted by Panasonic Communications (Malaysia) Sdn. Bhd., and may be reproduced for internal use only. All other reproduction, in whole or in part, is prohibited without the written consent of Panasonic Communications (Malaysia) Sdn. Bhd.

© 2006 Panasonic Communications (Malaysia) Sdn. Bhd. All Rights Reserved.



TS4100

PQQX15541YA FM0706FS1086