

# Panasonic®

## Operating Instructions

### 2.4 GHz Portable Station

---

Model No. **KX-TD7694**



**Thank you for purchasing a Panasonic 2.4 GHz Portable Station.  
Please read this manual carefully before using this product and save this  
manual for future use.**

**Please use only the battery provided and charge the battery for about 7 hours  
before using the handset for the first time.**

**See page 66 for System Requirements.**

---

# Table of Contents

<b>Before Initial Use</b> .....	<b>4</b>
<b>Accessories (included)</b> .....	<b>4</b>
<b>Installation</b> .....	<b>5</b>
Battery Installation.....	5
Charger Connection .....	5
Charging the Battery .....	5
Charger Wall Mounting .....	6
Attaching the Belt Clip.....	6
<b>Before Operating the Handset</b> .....	<b>7</b>
<b>Location of Controls</b> .....	<b>7</b>
Key Lock .....	8
Meeting Mode .....	9
<b>Selecting the Display Language</b> .....	<b>10</b>
<b>Editing the Standby Display Name</b> .....	<b>10</b>
<b>Editing the Names of the Flexible CO Keys</b> .....	<b>11</b>
<b>Adjusting the Ringer Volume</b> .....	<b>12</b>
<b>Adjusting the Ringer Volume or Turning the Ringer off while Ringing</b> .....	<b>12</b>
<b>Changing the Vibrate Setting</b> .....	<b>13</b>
<b>Adjusting the Receiver/Speaker/Headset Volume</b> .....	<b>13</b>
<b>Display</b> .....	<b>14</b>
<b>Soft Keys</b> .....	<b>15</b>
<b>Operation Outline</b> .....	<b>17</b>
<b>Function Menus</b> .....	<b>18</b>
<b>Function Keys</b> .....	<b>19</b>
<b>Flexible CO Keys</b> .....	<b>20</b>
<b>Operation</b> .....	<b>21</b>
<b>Making Calls</b> .....	<b>21</b>
Searching for an item stored in the Phonebook .....	24
<b>Receiving Calls</b> .....	<b>27</b>
Caller ID .....	28
<b>During a Conversation</b> .....	<b>29</b>
<b>Useful Features</b> .....	<b>30</b>
<b>Making Use of the Voice Mail Service</b> .....	<b>34</b>
<b>Using the Handset Phonebook</b> .....	<b>35</b>
<b>Handset Phonebook</b> .....	<b>35</b>
Private Ring.....	35
<b>Storing an Item in the Handset Phonebook</b> .....	<b>35</b>
Storing a New Item.....	35
Editing a Stored Item.....	36
Storing an Item Using the Predialing.....	37
Storing an Item Using the Outgoing Call Log.....	37
Storing an Item Using the Incoming Call Log.....	38
Storing an Item Using the PBX System Phonebook .....	39
Storing an Item Using the PBX Extension Phonebook .....	39
Editing Category Names .....	40
<b>Assigning Hot Keys</b> .....	<b>41</b>
<b>Entering Characters</b> .....	<b>42</b>





---

Character Mode Table .....	43
<b>Locking the Handset Phonebook .....</b>	<b>44</b>
Locking the Handset Phonebook .....	44
Unlocking the Handset Phonebook .....	44
Unlocking the Handset Phonebook Temporarily .....	44
<b>Deleting Stored Items .....</b>	<b>45</b>
<b>Deleting Stored Items in Handset Phonebook/Hot Key Dial/Outgoing Call</b>	
<b>Log/Incoming Call Log .....</b>	<b>45</b>
Handset Phonebook .....	45
Hot Key Dial .....	45
Outgoing Call Log .....	46
Incoming Call Log .....	46
<b>Configuring Handset Settings .....</b>	<b>47</b>
<b>Changing the Initial Settings.....</b>	<b>47</b>
Handset Setting Menu Layout .....	48
Memo Alarm Setting .....	55
<b>Troubleshooting and Error Messages .....</b>	<b>57</b>
<b>Troubleshooting .....</b>	<b>57</b>
<b>Error Messages .....</b>	<b>59</b>
<b>Important Information .....</b>	<b>60</b>
<b>Battery Information .....</b>	<b>60</b>
<b>Important Safety Instructions .....</b>	<b>61</b>
<b>FCC Information .....</b>	<b>63</b>
Customer Information .....	64
<b>Other Important Information .....</b>	<b>65</b>

## Before Initial Use

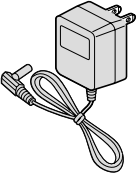
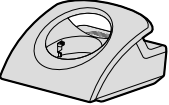
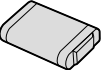
Please read “Important Information” on page 60 before using. Read and understand all instructions.

### Accessories (included)

AC adaptor ..... One  [Part No.] PQLV207	Charger ..... One  [Part No.] PSWETD7694M	Battery ..... One  [Part No.] N4HHGMB00005 or HHR-P103
Belt Clip ..... One  [Part No.] PSKE1093Z1	Battery Cover ..... One  [Part No.] PSYNTD7694MR	Screws and Washers ..... Two  [Part No.] Screws: PQHE5004Y Washers: XWG35FJ

- To order accessories, call toll free **1-800-332-5368**.

## Installation

### Battery Installation

Insert the battery, and close the cover as indicated below.

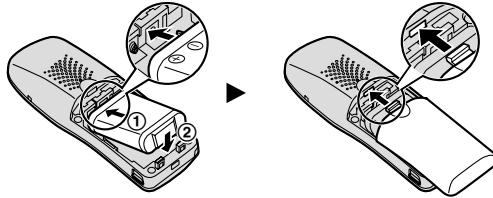

### Charger Connection

Connect the AC adaptor to the charger.

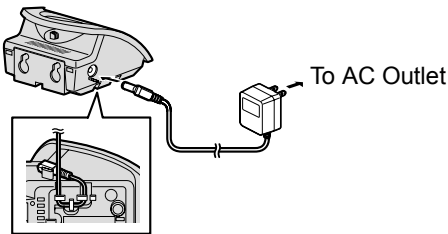

- The AC adaptor should be connected to a vertically oriented or floor-mounted AC outlet. Do not connect the AC adaptor to a ceiling-mounted AC outlet, as the weight of the adaptor may cause it to become disconnected.
- Fasten the AC adaptor cord to the cord holder.
- Use only the Panasonic AC adaptor PQLV207.

### Charging the Battery

At the time of shipment, the battery is not charged. **Please charge the battery for about 7 hours before using the handset for the first time.**

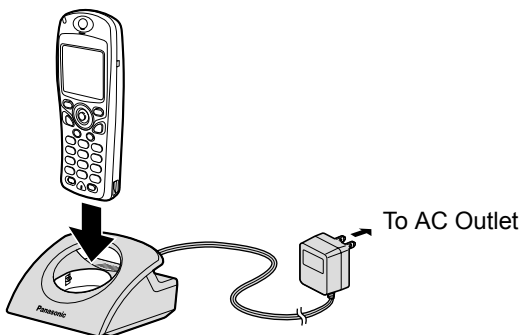

- When the battery has been completely charged, the charge indicator will change from red to green. For more information, refer to "Battery Information" on page 60.
- It is normal for the handset and charger to feel warm while the battery is charging.
- Keep devices sensitive to magnetic fields away from the charger.
- Use only the included charger.

### Charger Wall Mounting

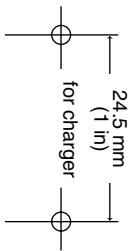

1. Install the two included screws in the wall, spacing them 24.5 mm (1 in) apart.

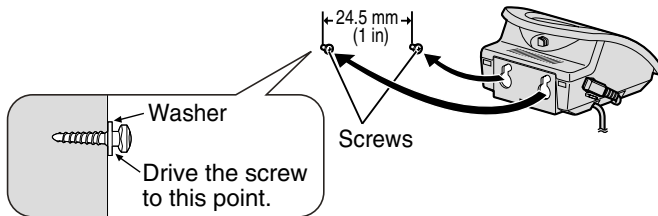

2. Mount the charger securely on the wall.

- Make sure that the wall that the charger will be attached to is strong enough to support the weight of the handset and charger (240 g [0.53 lb]). If not, it is necessary for the wall to be reinforced.
- When this product is no longer in use, make sure to detach it from the wall.

---

### Attaching the Belt Clip

You can attach the handset to your belt by following the steps below.

#### [To attach]

Allows phone straps and similar objects to be connected.

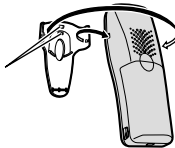

Insert the clip into the designated notches in the handset.

#### [To remove]



Remove the belt clip.

## Location of Controls

The headset is an option.  
Please use only a Panasonic  
headset below:  
KX-TCA86/KX-TCA88HA/  
KX-TCA91/KX-TCA92

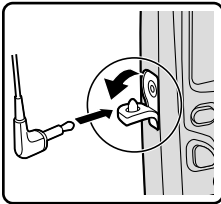

Open the cover.

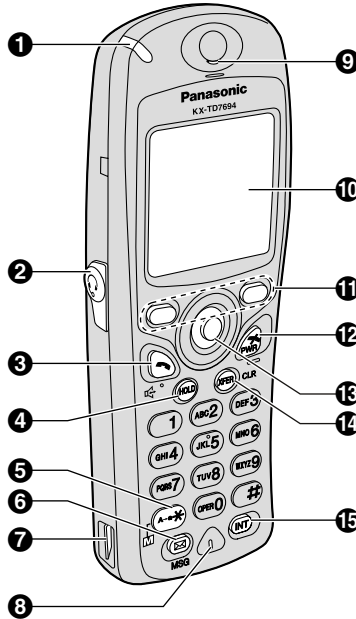

[Back View]

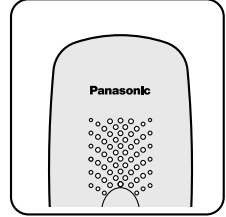

Speaker

**12** Press **POWER** for more than 2 seconds.  
**[Power On]**  
Standby mode  
**[Power Off]**  
Blank display

**13**

Up

Left  Right

Down

You can use the Joy-stick to move the cursor in the desired direction. Press the center button to confirm a selection.

## Before Operating the Handset

---

### ❶ Ringer/Charger Indicator

### ❷ Headset Jack

### ❸ TALK/SP-PHONE (Speakerphone) Key

Used to make or answer calls, or toggle between the Receiver/Hands-free\*<sup>1</sup> mode during a conversation.

### ❹ HOLD Key

Used to place a call on Hold.

### ❺ Meeting Mode Key

Used to turn Meeting Mode on or off when pressed for more than 2 seconds in standby mode.

For more information, refer to "Meeting Mode" on page 9.

### ❻ Message Key

Used to leave a message waiting indication, or to call back the party who left a message waiting indication.

### ❼ Charge Contact

### ❽ Microphone

### ❾ Receiver

\*<sup>1</sup> You can talk with the other party alternately through the speaker in a quiet room. During a conversation using a headset, Hands-free mode does not work.

### ❿ Display

Refer to "Display" on page 14.

### ⓫ Left/Right Soft Key

Used to select the function displayed directly above each key. Functions are displayed based on the current context.

### ⓬ POWER/CANCEL Key

Used to end calls, exit the Phonebook or Function mode, or turn the handset on or off.

### ⓭ Joystick

Used to adjust the ringer/receiver volume, select Function menus and the function displayed directly above it, and to move the cursor to select a desired item.

### ⓮ TRANSFER/CLEAR Key

Used to transfer a call to another party, or to clear digits or characters.

### ⓯ INTERCOM Key

Used to make or answer intercom calls.

---

## Key Lock

You can lock all keys other than the Joystick while the handset is in standby mode.

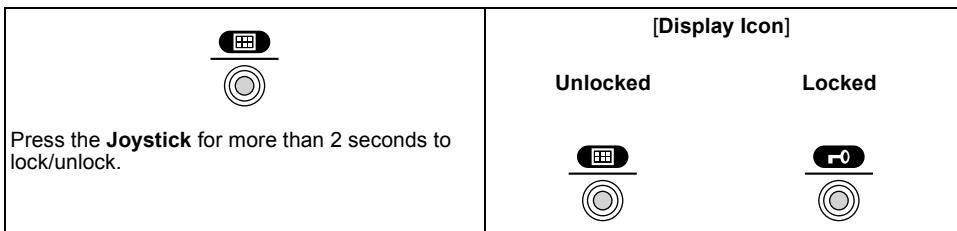



### **Meeting Mode**

Meeting Mode allows you to turn off the ringer and set the handset to vibrate when calls are received. This can be useful in situations where you do not want to be disturbed, such as during a meeting.

When Meeting Mode is active, the microphone's sensitivity is increased, and the following features are turned off automatically, regardless of their settings.

- Ringer Volume
- Ring On Charger
- Auto Answer
- Key Tone
- Range Alarm
- Low Battery Alarm

- If you set the handset on the charger during Meeting Mode, the handset will not vibrate<sup>\*1</sup>.

<sup>\*1</sup> Please note that if you set the handset on the charger while receiving an incoming call, vibration will stop. Once the vibration stops, the handset will not vibrate again for that call, even if the handset is lifted up again. (If Quick Answer is set, lifting up the handset will answer the call.)

### Selecting the Display Language

You can select the desired language (English/Spanish/French).

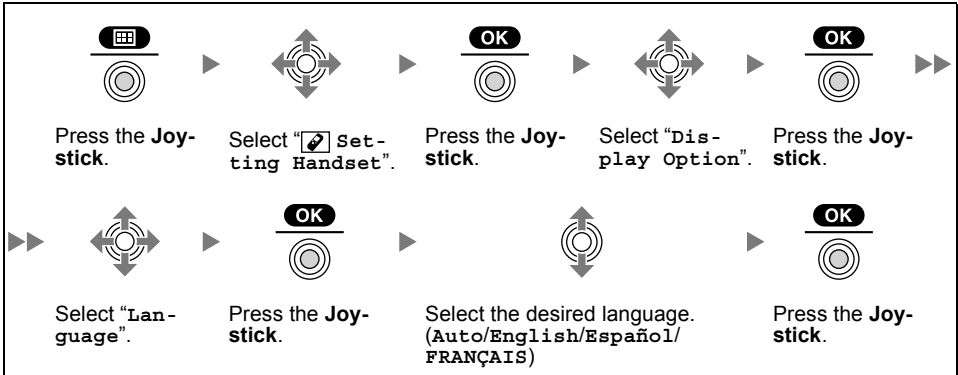

- When set to "Auto", the language settings of the PBX will be used.
- The display language of both the handset and PBX can be selected, and both should be set to the same language. For more information, refer to the user documentation for your PBX.

### Editing the Standby Display Name

You can edit the name of the standby mode display of the handset.

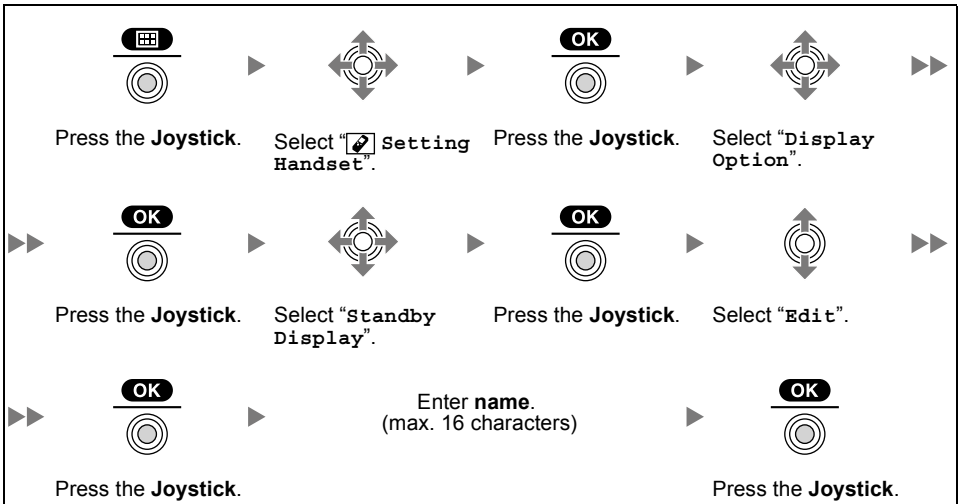

- To enter characters, see page 42.

## Editing the Names of the Flexible CO Keys

You can edit a name for each flexible CO key of the handset.

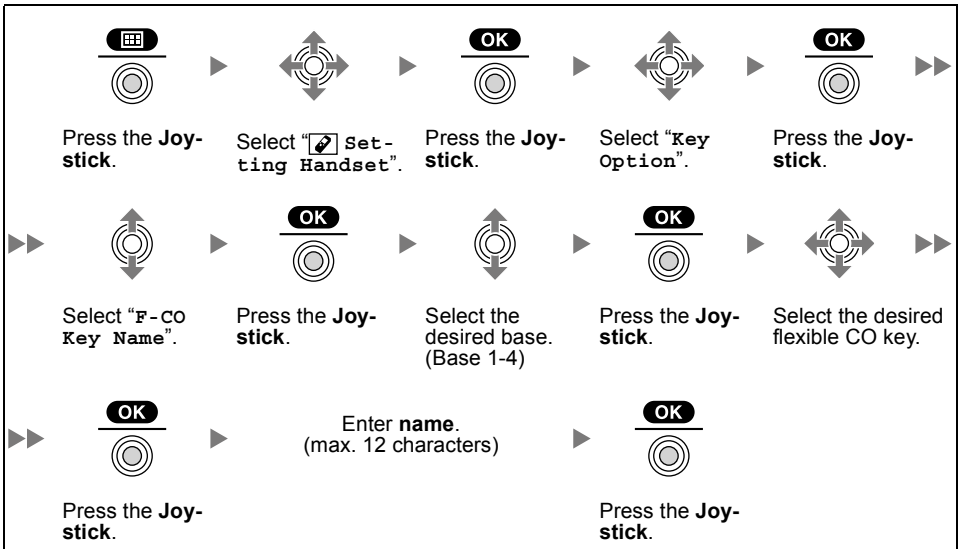

- To enter characters, see page 42.

## Adjusting the Ringer Volume

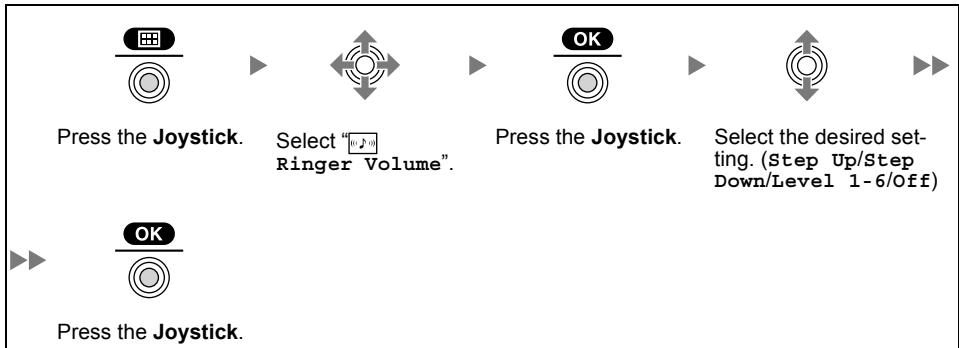

- To set the ringer pattern, see page 49.

## Adjusting the Ringer Volume or Turning the Ringer off while Ringing

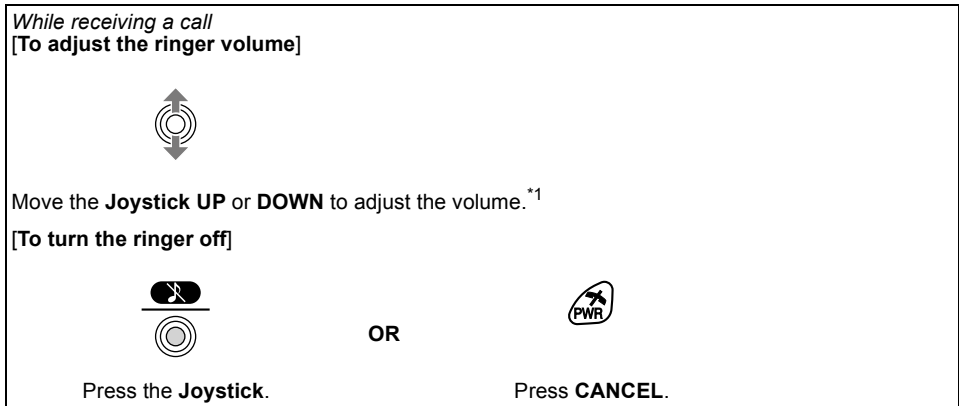

\*1 The adjusted volume level will also be used for subsequent calls.

- If you attach the headset while receiving an incoming call, the ring from the handset does not switch to the headset. If you attach the headset before receiving an incoming call, and headset tone is set to on, a tone will be heard from the headset. If Vibrate is set to on, the handset will vibrate whether a headset is attached or not.

## Changing the Vibrate Setting

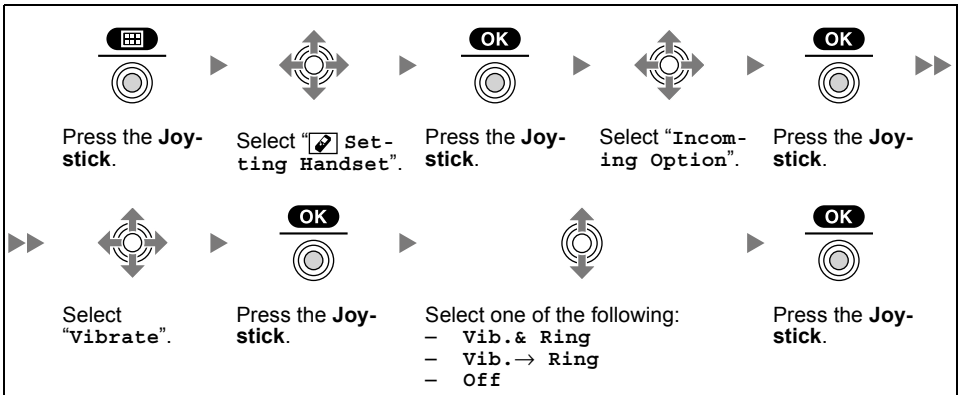

- To set Vibrate only, without ringing, select **"Vib. & Ring"** and set the Ringer Volume to off, or turn Meeting Mode on. (See page 9, 12.)

## Adjusting the Receiver/Speaker/Headset Volume

*During a conversation*



Move the **Joystick UP** or **DOWN** to adjust the volume.  
(Receiver Volume—Level 1-4, Speaker Volume—Level 1-6, Headset Volume—Level 1-4)

## Display

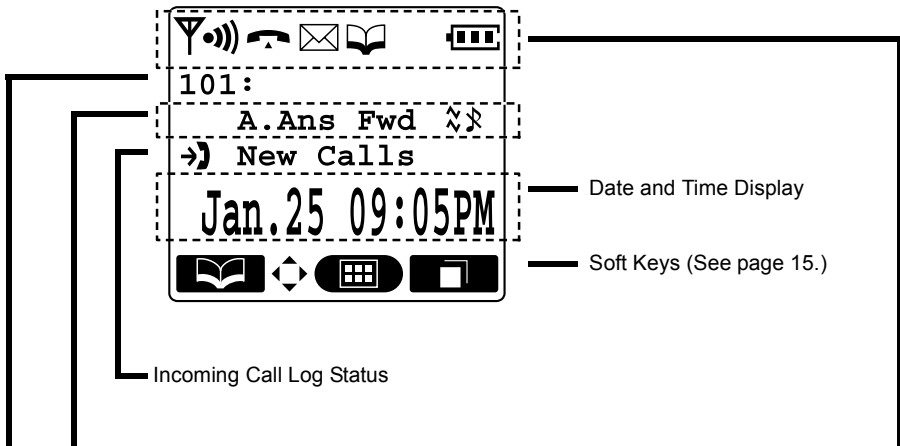

**A. Ans** Auto Answer

**Fwd** Call Forwarding (See page 30.)

**DND** Do Not Disturb (See page 30.)

**🔕** Ringer Volume OFF (See page 12.)

**M** Meeting Mode (See page 9.)

**🔔** Vibrate (See page 13.)

**📶** Within range of a Cell Station (CS)

**📶** Out of range

**📞** Intercom Indicator

**📞** Off-hook Status

**✉** Message Waiting

**📖** Phonebook

### Battery Indicator\*1

**🔋** Full

**🔋**

**🔋** Low























**🔋** Needs to be charged.

Extension Number  
To edit the standby display name, see page 10.













\*1 Refer to "Battery Information" on page 60.

## Soft Keys

Icons and information shown on the display will vary depending on the context. To select an item shown on the display, press the corresponding soft keys.

	Opens the Phonebook. Pressing this key for more than 2 seconds locks the Phonebook.		Displayed when in Special character entry mode. Pressing this key switches to Alphabetic character entry mode.
	Displayed when in Phonebook Lock. Pressing this key and then entering the password (default: 1234), unlocks the Phonebook temporarily. Pressing for more than 2 seconds, then entering the password (default: 1234), unlocks the Phonebook.		Inserts a dialing pause.
	Stores a new item in the Phonebook.		Clears digits or characters.
	Opens the PBX System Phonebook.		Turns the microphone mute on or off during a conversation. Flashes when Mic Mute is on.
	Opens the PBX Extension Phonebook.		Turns the ringer off.
	Displays the caller information stored in the Handset Phonebook while receiving a call.		Opens the main menu. Pressing this key for more than 2 seconds locks all keys.
	Displays the caller information stored in the system while receiving a call.		Returns to the previous display.
	Establishes a multiple-party conversation (Conference).		Opens the list menu (edit/delete in the Phonebook, etc.).
	Searches for an item in the Phonebook alphabetically.		Confirms the entry.
	Displayed when in Alphabetic character entry mode. Pressing this key switches to Numeric character entry mode.		Displayed when in Key Lock mode. Pressing this key for more than 2 seconds unlocks the keys.
	Displayed when in Numeric character entry mode. Pressing this key switches to Special character entry mode.		Advances to the next display.

## Before Operating the Handset

	Displays the Outgoing Call Log.		Used to clear the Memo Alarm display setting.
	Displays the last dialed number.		Used to enter an “x” when storing the Line Access CD.
	Opens the Incoming Call Log.		Disconnects the current call and make another call without hanging up.
	Opens the Incoming Call Log Group.		Used to register the handset with the PBX simply.
	Used to select an item when in setting mode.		Displayed when it is possible to use an arrow key to make a selection.
	Used to select AM or PM when setting the Memo Alarm feature.	 	Displayed when the corresponding soft key has no function.



## Operation Outline

Handset functions are accessed through the display menu and selected with the Joystick and soft keys. The guidance display is shown in standby mode for easy operation.

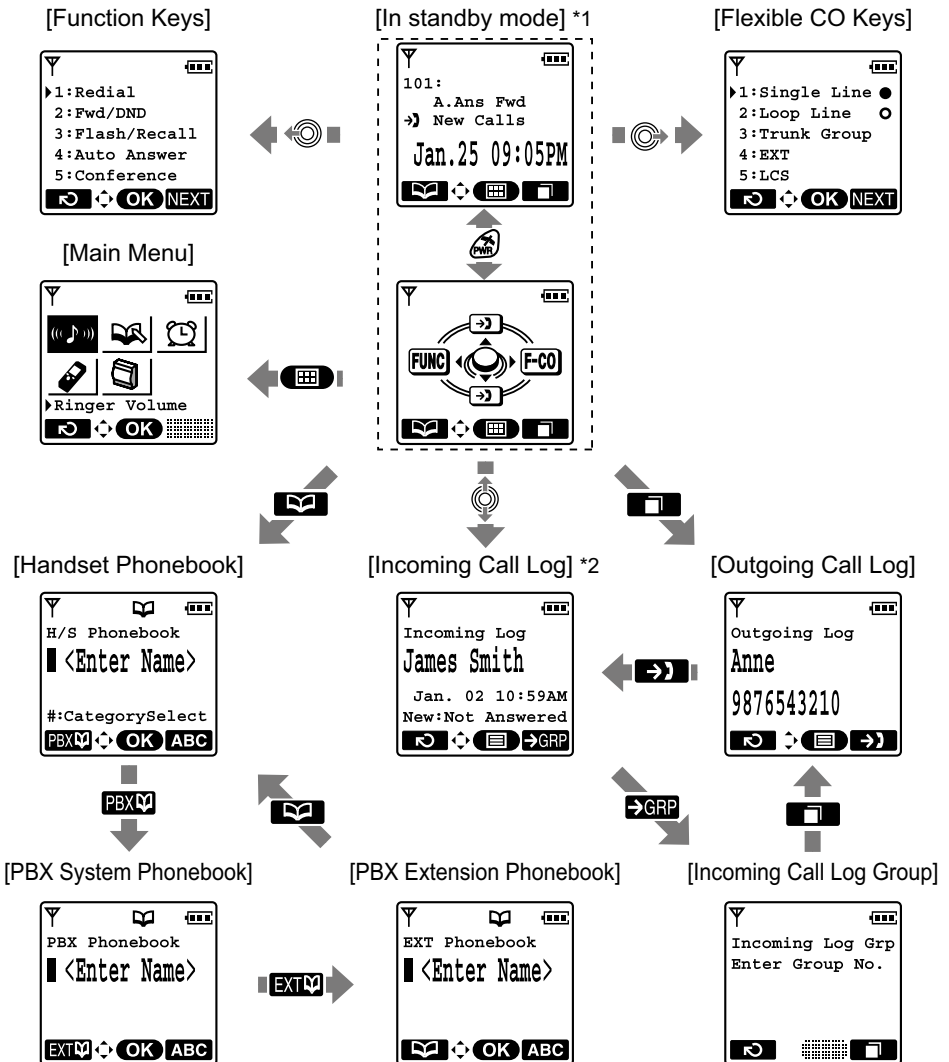

\*1 You can select whether the guidance display is shown or not. (See page 52.)

\*2 Moving the Joystick  displays the phone number.

- To enter characters, see page 42. To search for an item stored in the Phonebook, see page 24.

### Function Menus

Press the Joystick to display the main and sub menus.

#### Main Menu—While in Standby Mode

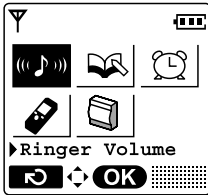

**Ringer Volume:**

Accesses the “Ringer Volume” setting.



**New Phonebook:**

Stores a new item in the Phonebook.



**Memo Alarm:**

Accesses the “Memo Alarm” settings.



**Setting Handset:**

Accesses the “Setting Handset” settings.



**PBX Program:**

Enters PBX Personal Programming mode. For PBX Personal Programming, refer to the user documentation for your PBX. Press  to exit from PBX Personal Programming mode.

#### Sub Menu—While Off-hook/During a Conversation



**Phonebook:**

Opens the Phonebook.



**New Phonebook:**

Stores a new item in the Phonebook.



**Outgoing Call Log:**

Enters the Outgoing Call Log.



**Incoming Call Log:**

Enters the Incoming Call Log.

## Function Keys

Functions of the handset can be activated through the display key list.

Move the Joystick  to display the feature key list.

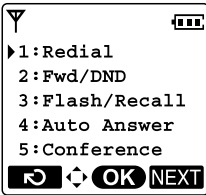

### 1: Redial

Redials the last dialed number.

### 2: Fwd/DND

Displays and/or sets Call Forwarding and Do Not Disturb.

### 3: Flash/Recall

Disconnects the current call and make another call without hanging up.

### 4: Auto Answer

Answers an incoming call automatically in hands-free mode. "A. Ans" is displayed in standby mode.

### 5: Conference

Establishes a multiple-party conversation.

### 6: Pause

Inserts a dialing pause.

### 7: Auto Dial







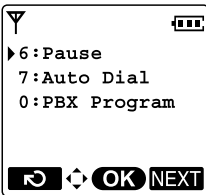









Makes a call through PBX Personal/System Speed Dialing.

### 0: PBX Program

Enters PBX Personal Programming mode. Press  to exit from PBX Personal Programming mode.



- For PBX Personal Programming, refer to the user documentation for your PBX.

Shortcut Combinations			
 	<b>Redial</b>	 	<b>Conference</b>
 	<b>Fwd/DND</b>	 	<b>Pause</b>
 	<b>Flash/Recall</b>	 	<b>Auto Dial</b>
 	<b>Auto Answer</b>	 	<b>PBX Program</b>

- For operation, see page 21.
- To edit the function key list, see page 51.

### Flexible CO Keys

A flexible CO key can be used either to seize a line in order to make or receive an outside call (F-CO key), or used as a function key. Move the Joystick  to display the flexible CO key list. Here you can access the 12 flexible CO keys. The icon shown beside each F-CO key indicates line status similarly to the LED indicators on a Proprietary Telephone; ● is the same as a green LED, and ○ is the same as a red LED.

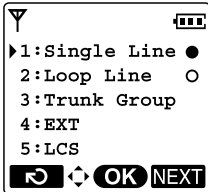

[Example]



#### Understanding the F-CO Key Icons\*1

● (on):	You are currently using this line.
⋈ (flashing rapidly):	You have an incoming call on this line. (An outside call is coming in on a single extension.)
⋈ (flashing slowly):	You have a call on hold on this line.
○ (on):	This line is in use by someone else.
⋈ (flashing rapidly):	You have an incoming call on this line. (An outside call is coming in on multiple extensions simultaneously.)
⋈ (flashing slowly):	Someone has a call on hold on this line.
(no icon)	This line is idle.

\*1 The meanings of these icons vary depending on the status of the CO line.

- To select a key, press its key number, or move the Joystick  to select the desired key and press .
- To edit the names of flexible CO keys, see page 11.
- For more information, refer to the feature documentation for your PBX.

# Making Calls

Calling	
To an extension	► Extension No. ►
To an outside party	<p>To use the Line Access Numbers</p> ► (  OR  ► CO Line Group No. ) ► Outside Phone No. ►
To use Flexible CO Keys	► (  (idle CO key no. [0-9, *, #]) OR  (idle CO key) ►  ) ► Outside Phone No. ►
To use Hot Key Dial* <sup>1</sup>	(Press the dialing key assigned as a Hot Key for more than 1 second.) ►  ►
To use the Outgoing Call Log* <sup>2</sup>	►  ►  ►
To use the Incoming Call Log	►  ►  ►  ►
To use the Incoming Call Log Group	►  ►  ► Incoming Call Log Group No. ►  ►  ►  ►
To use the Handset Phonebook* <sup>3</sup>	► Name* <sup>4</sup> ► (  OR  ) ►  (if required) ►  ►

# Operation

## Calling

To use the PBX System Phonebook\*<sup>2</sup> \*<sup>3</sup>



To use the PBX Extension Phonebook\*<sup>3</sup>



## One-touch Dialing

To store

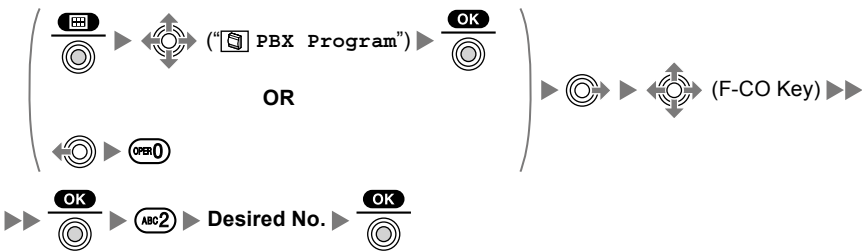

To dial

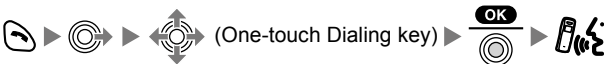

## Hot Line

To store



To set/cancel



























To dial



## Operator Call



System Speed Dialing	
<b>To dial</b>  ►   ► System Speed Dial No. (3 digits) ► 	
Doorphone Call	
 ►    ► Doorphone No. (2 digits) ► 	
Automatic Callback Busy	
<b>To set</b> <i>While hearing a busy tone</i>  ► 	<b>To cancel</b>  ►    ► 
<b>To answer from an idle extension</b> <i>While hearing a callback ring</i>  ► 	<b>To answer from an idle outside line</b> <i>While hearing a callback ring</i>  ► Outside Phone No. ► 



- \*1 To assign a phone number to a Hot Key, see page 41.
  - \*2 When a call is made using the PBX System Phonebook, the called party's name is not stored in the Outgoing Call Log. To log the name as well as the number, copy the item into the Handset Phonebook before dialing it. (See page 39.)
  - \*3 To store an item in the Phonebook, see page 35.  
To search for an item stored in the Phonebook, see page 24.
  - \*4 This step can be omitted.
- To enter characters, see page 42.
  - You can confirm that the number was dialed correctly before calling (**Predialing**) by entering the number, then pressing .
  - To clear an entire number while predialing, press  for more than 1 second.
  - If an outside call is received from a phone number stored in the Handset Phonebook, the number and name of the caller will be displayed in the call log.
  - To cancel dialing, press .
  - If “” flashes, move closer to the CS and dial again.
  - For more information, refer to the user documentation for your PBX.

## Searching for an item stored in the Phonebook

You can search for an item in the Phonebook by following the steps below.

### Handset Phonebook

**Scrolling through all items**

 ▶ 





Press the **Left Soft Key**.      Press the **Joystick UP** or **DOWN** repeatedly.

---

**Searching by name or first character(s) of name**

 ▶ Enter name or first character of the desired name. ▶▶





Press the **Left Soft Key**.

▶▶   **OR**  ▶ 





Press the **Joystick**.      Move the **Joystick UP** or **DOWN**.      Select the desired item. (if required)

---

**Searching by category**

 ▶  ▶  ▶  ▶▶

Press the **Left Soft Key**.      Press #.      Select the desired Category Number.      Press the **Joystick**.

▶▶ Enter name.\*1 ▶   **OR**  ▶ 

Press the **Joystick**.      Move the **Joystick UP** or **DOWN**.      Select the desired item. (if required)

\*1 This step can be omitted.

- To enter characters, see page 42.
- While an item is displayed you can:
  - Return to the “<Enter Name>” display by pressing , then search for another item.



- Search for another item by pressing the dial key that corresponds to the letter you are searching for. If there is no entry that corresponds to the letter you selected, the next entry will be displayed.

**PBX System Phonebook**

**Scrolling through all items**

Press the **Left Soft Key**.      Press the **Left Soft Key**.      Press the **Joystick UP** or **DOWN** repeatedly.

---

**Searching by name or first character(s) of name**

Press the **Left Soft Key**.      Press the **Left Soft Key**.      Enter name or first character of the desired name.

Press the **Joystick**.      OR      Move the **Joystick UP** or **DOWN**.      Select the desired item. (if required)

- To enter characters, see page 42.
- While an item is displayed you can:
  - Return to the “<Enter Name>” display by pressing , then search for another item.
  - Search for another item by pressing the dial key that corresponds to the letter you are searching for. If there is no entry that corresponds to the letter you selected, the next entry will be displayed.

# Operation

## PBX Extension Phonebook

### Scrolling through all items



Press the **Left Soft Key**.



Press the **Left Soft Key**.



Press the **Left Soft Key**.



Press the **Joystick UP or DOWN** repeatedly.

### Searching by name or first character(s) of name



Press the **Left Soft Key**.



Press the **Left Soft Key**.



Press the **Left Soft Key**.



Enter name or first character of the desired name.



Press the **Joy-stick**.

OR





Move the **Joystick UP or DOWN**.



Select the desired item. (if required)

- To enter characters, see page 42.
- While an item is displayed you can:
  - Return to the “<Enter Name>” display by pressing , then search for another item.
  - Search for another item by pressing the dial key that corresponds to the letter you are searching for. If there is no entry that corresponds to the letter you selected, the next entry will be displayed.

## Receiving Calls

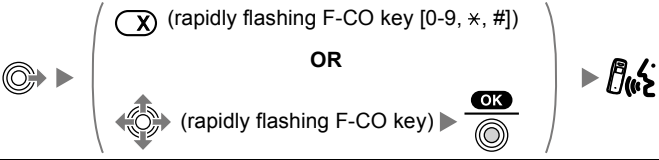
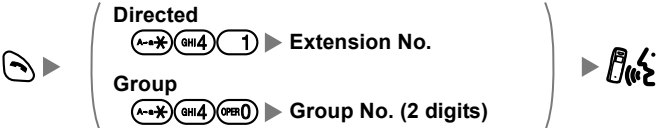
Receiving
<p><b>An Intercom Call/An Outside Call/An Group Call</b></p> 
<p><b>An Intercom Call</b></p> 
<p><b>An Outside Call on a specific line</b></p> 
Call Pickup

- You can also answer a call with the following features:
  - Any Key Answer (See page 51.)
  - Quick Answer (See page 51.)
  - Auto Answer (See page 51.)
- You can select the ringer, LED, and vibrate pattern for each type of incoming call. (See page 49.)
- For more information, refer to the user documentation for your PBX.

### Caller ID

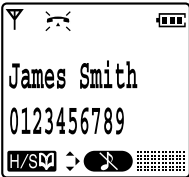

If an outside call that contains Caller ID information (a caller's name and telephone number) is received, this information will be logged in the incoming call log and displayed on the handset in one of the two following ways.

- If the caller's information is stored in the PBX, that information can be displayed.

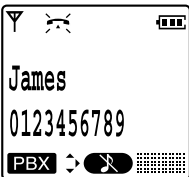

- If the caller's information is stored in the handset, that information can be displayed.



- If information is stored in both the PBX and in the handset for the same caller, you can choose which information will be displayed on the handset. Caller information stored in the PBX is displayed by default. (See "Caller ID Disp" on page 52.) If you set the handset to display the caller information stored in the handset, caller information stored in the PBX will be displayed if the caller is not stored in the handset. When receiving a call, you can display the information stored in the handset by pressing , and display the information stored in the PBX by pressing .
- The caller information can be displayed even if a line access number, outside line number, or P () is stored in the Phonebook. (See "Line Access CD" on page 54.)

## During a Conversation

### Transferring a Call

To an extension



To an outside party



### Holding

To hold (Regular Hold)



To hold (Exclusive Call Hold)



To retrieve a call

An Intercom Call



An Outside Call

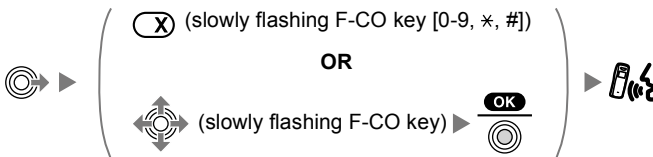

### Three-party Conference

To add another party during a conversation

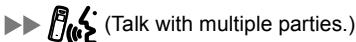

To leave a conference



- To return to the call before the transfer destination answers, press **XFER**.
- The method used to hold a call depends on the Call Hold mode (Regular Hold/ Exclusive Call Hold). Ask your manager what the current mode is.

## Operation

- When you hold several outside calls, you need to assign F-CO Keys (Single Line/Loop Line/Trunk Group) as necessary beforehand.
- For more information, refer to the user documentation for your PBX.

## Useful Features

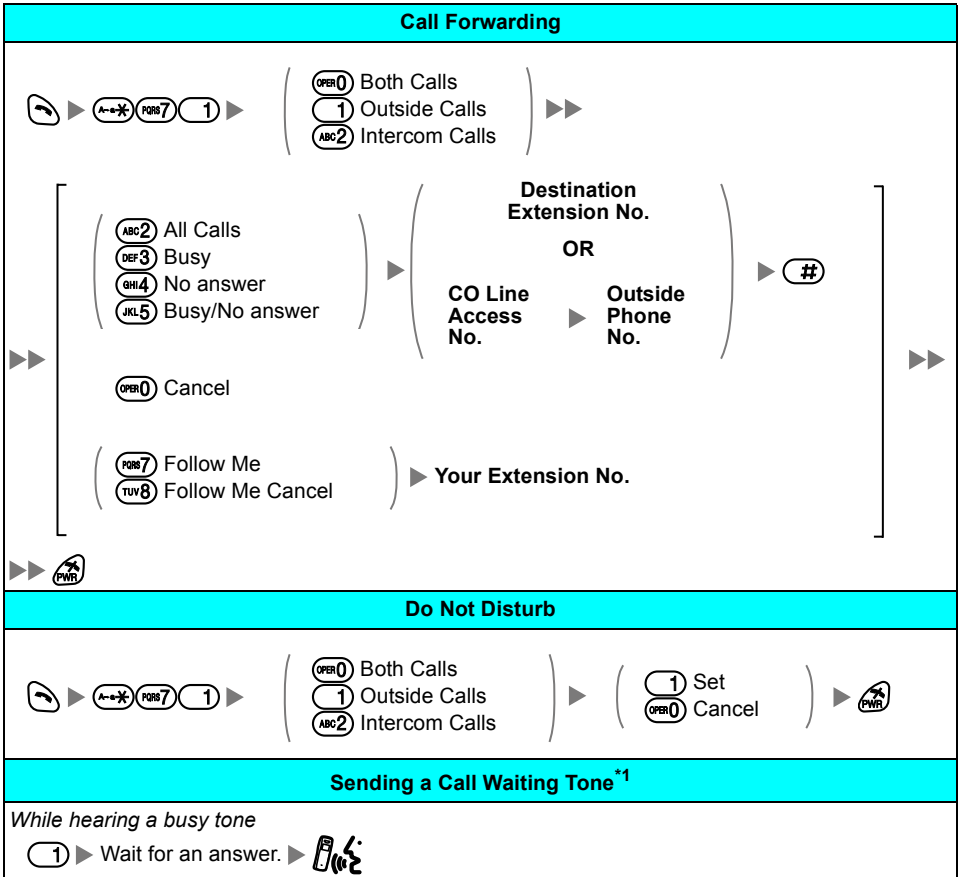

**Call Waiting**

**To set/cancel for intercom calls**



**To set/cancel for outside calls**



**To talk to the new party (While hearing the Call Waiting tone)**

**To terminate a current status**



**To hold and then talk to the new party**

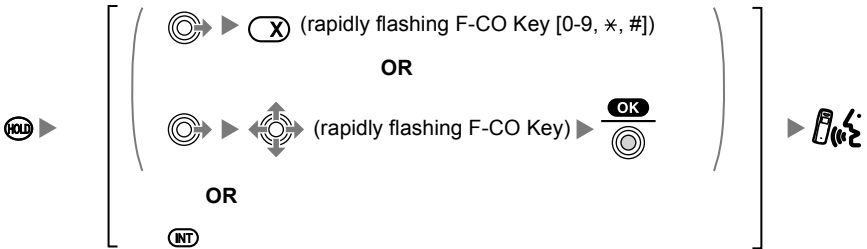

Disregard this step if both parties are extensions.

**Paging**

**To page**

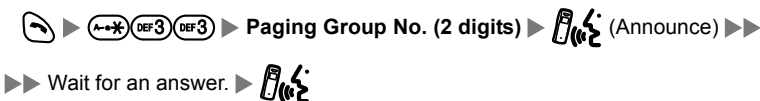

**To answer**



# Operation

## Absent Message

To set

► ►
 

1	Will Return Soon
ABC 2	Gone Home
DEF 3	At Ext %%% + Extension no.
GHI 4	Back at %:%% + Hour:Minute
JKLM 5	Out until %/%% + Month/Day
MNO 6	In a Meeting
PQRS 7	
TUV 8	
WXYZ 9	

 ►►

\*2

Enter required no.

►► ►

To cancel

► ►

## Log-in/Log-out

►
 

For Log-in	

 ►
 

Specified ICD Group* Extension No.	
All	

 ►►

For Log-out:

\* ICD Group: Incoming Call Distribution Group

►►

## Extension Feature Clear

► ►

## Message Waiting

Caller

**To leave a message waiting indication**  
 When the called extension is busy or does not answer

( OR ) ►

**To cancel a message waiting indication**

► ► Desired Extension No. ►



**Message Waiting**

Called extension

To call back

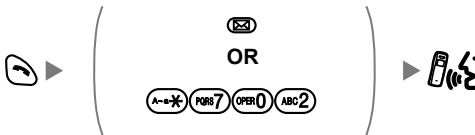

**Extension Dial Lock\*<sup>3</sup>**

To lock

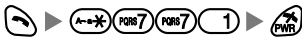

To unlock



\* PIN: Personal Identification Number

- \*1 You cannot send a call waiting tone when
  - the called party has not set the Call Waiting feature.
  - the called party has set the Data Line Security feature.
- \*2 Enter the desired value in the “%” positions. You must enter the correct number of characters as represented by the “%” using 0 to 9 or \*.  
 To change the default messages and create your personal messages (Message no. 9), refer to the documentation for your PBX.
- \*3 If you do not set an extension PIN, you cannot lock and unlock your extension.
- For more information, refer to the user documentation for your PBX.

## Making Use of the Voice Mail Service

Listening to a Message	
<p><b>From your own extension</b></p> <p> ► <b>VPS* Extension No.</b> ►►</p> <p>►► <b>Mailbox Password*<sup>1</sup> + (#)</b></p> <p>· If you have no password, you can skip the last step.</p> <p>* VPS: Voice Processing System</p> <hr/> <p><b>From someone else's extension</b></p> <p> ► <b>VPS Extension No.</b> ► (#) (MNO)6 ►►</p> <p>►► (A→*) ► <b>Mailbox No.</b> ►►</p> <p>►► <b>Mailbox Password*<sup>1</sup> + (#)</b></p> <p>· If you have no password, you can skip the last step.</p>	<p><b>KX-TVA series</b></p> <p>(</p> <ul style="list-style-type: none"> <li>(1) Listen to Message</li> <li>(ABC)2 Deliver Message</li> <li>(DEF)3 Mailbox Management</li> <li>(GHI)4 Automated Attendant</li> <li>(JKL)5 Message Notification</li> <li>(MNO)6 Other Features</li> <li>(A→*) End Call</li> </ul> <p>)</p> <hr/> <p><b>KX-TVS series</b></p> <p>(</p> <ul style="list-style-type: none"> <li>(1) Listen to Message</li> <li>(ABC)2 Deliver Message</li> <li>(DEF)3 Check Mailbox Distribution</li> <li>(GHI)4 Automated Attendant</li> <li>(JKL)5 Mailbox Management</li> <li>(MNO)6 Other Features</li> <li>(A→*) End Call</li> </ul> <p>)</p>
Leaving a Message	
<p><b>From your own extension</b></p> <p><b>Mailbox Password*<sup>1</sup> + (#)</b></p> <p><b>From someone else's extension</b></p> <p>(#) (MNO)6 ►► (A→*) ► <b>Mailbox No.</b> ►►</p> <p>►► <b>Mailbox Password*<sup>1</sup> + (#)</b></p> <p>· If you have no password, you can skip the last step.</p>	
<p>►► (ABC)2 ► Enter the desired mailbox no. ►► (ABC)2 (1) ► Leave a message ►► (1) (ABC)2 ►►</p> <p><b>To send the message immediately</b></p> <p>(</p> <ul style="list-style-type: none"> <li>(1) (ABC)2 (KX-TVA series)</li> <li>(ABC)2 (KX-TVS series)</li> </ul> <p>)</p> <p><b>To set the delivery time</b></p> <p>(1) (1) ► Follow the guidance</p>	
During Playback	
<p>(OPER)1 Repeat Voice Guidance</p> <p>(A→*) Exit Menu</p>	

\*1 For more information on the Mailbox Password, refer to the user documentation for the VPS.

- Some feature access numbers may vary depending on the market. Please consult your local dealer for the details.

## Handset Phonebook

You can store up to 100 items with names, phone numbers, and category numbers in the handset for easy access. You can set unique Ringer/LED/Vibrate patterns for each category to identify incoming calls. All Phonebook items are stored in alphabetical order. For security purposes, you can lock the Phonebook. To make a call using the Phonebook, see page 21.

### Private Ring

You can organize entries in the Phonebook into one of 9 Private Ring Categories. It is possible to set a different ringer/LED/vibrate pattern<sup>\*1</sup> for each category. When the displayed Caller ID<sup>\*2</sup> matches a phone number or name stored in the Phonebook, the handset rings according to the Private Ring Category settings.

\*1 For Ringer/LED/Vibrate patterns, see page 49.

\*2 For Caller ID information, see "Caller ID" on page 28.

## Storing an Item in the Handset Phonebook

### Storing a New Item

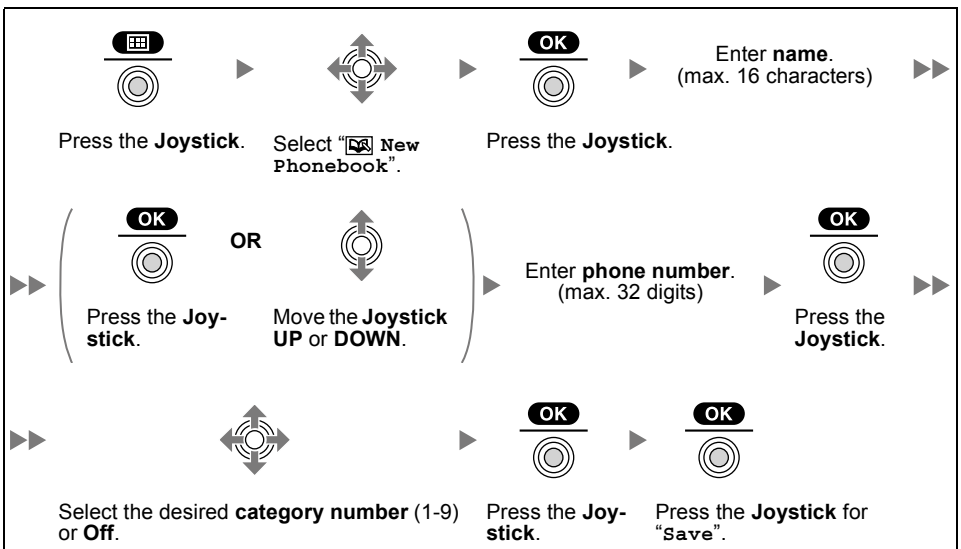





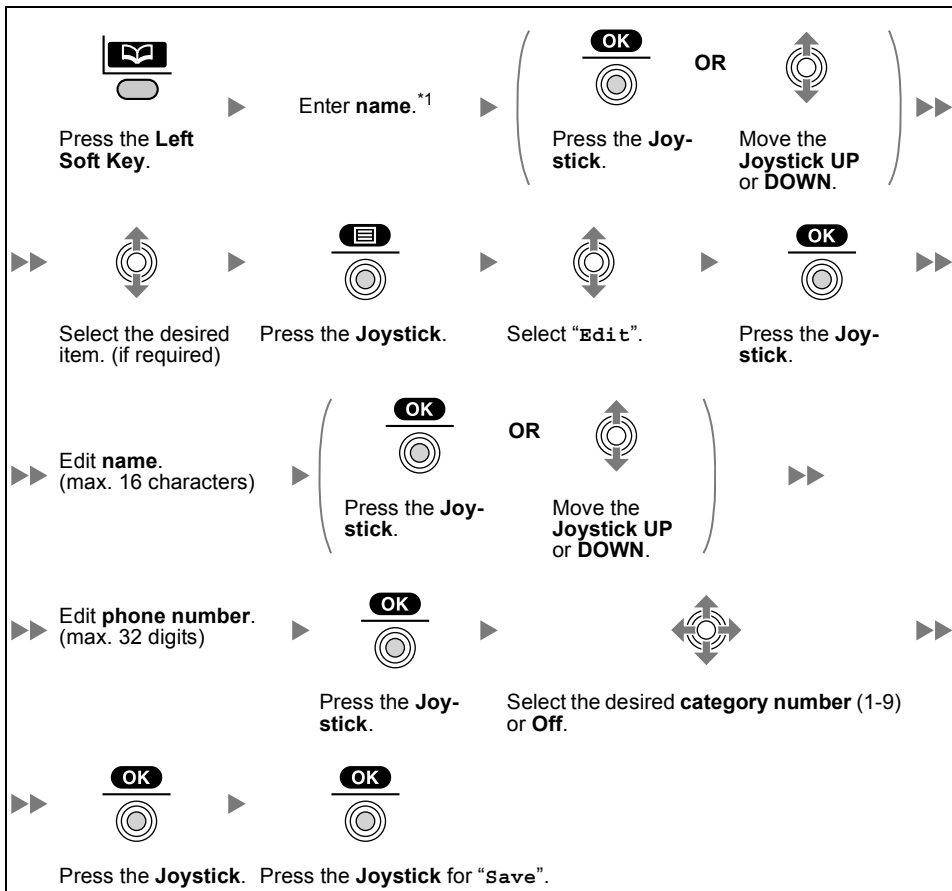

- To enter characters, see page 42.
- The valid digits are "0" through "9", "\*", "#", "P ()".
- When storing an outside phone number, you should first store a line access number.

## Editing a Stored Item



\*1 This step can be omitted.

- To enter characters, see page 42.
- To search for an item in the Phonebook, see page 24.
- The valid digits are "0" through "9", "x", "#", "P ()".
- To change a character or digit, move the Joystick  to highlight it, press  to delete it, then enter the new character or digit.
- To clear an entire line, press  for more than 1 second.
- To move the cursor to the left or right, move the Joystick  or , respectively.

## Storing an Item Using the Predialing

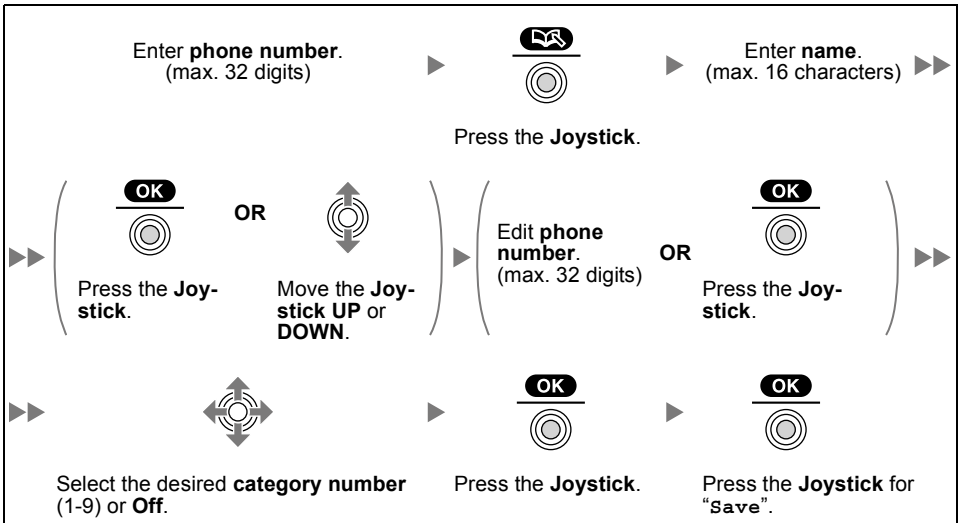

## Storing an Item Using the Outgoing Call Log

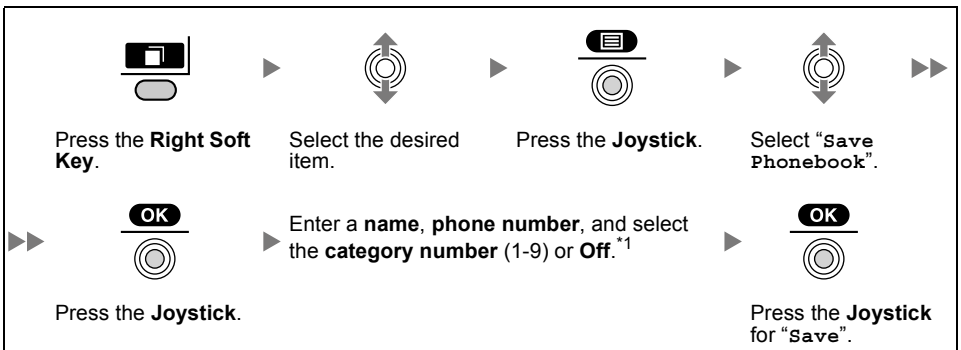

\*1 Press to confirm each entry. (**name:** max. 16 characters/**phone number:** 32 digits)

- When storing an outside phone number, the line access number will be stored automatically. The line access number must be identical to the handset's "Line Access CD" setting (Other Option). (See page 54.)

### Storing an Item Using the Incoming Call Log

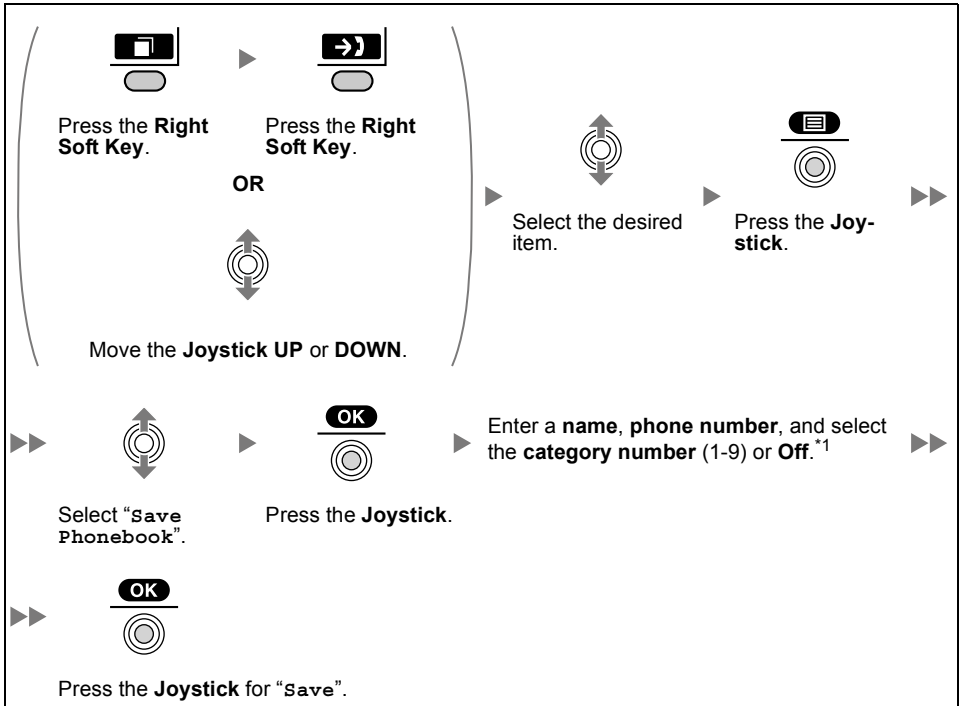

\*1 Press  to confirm each entry. (**name**: max. 16 characters/**phone number**: 32 digits)

- When storing an outside phone number, the line access number will be stored automatically. The line access number must be identical to the handset's "Line Access CD" setting (Other Option). (See page 54.)

## Storing an Item Using the PBX System Phonebook

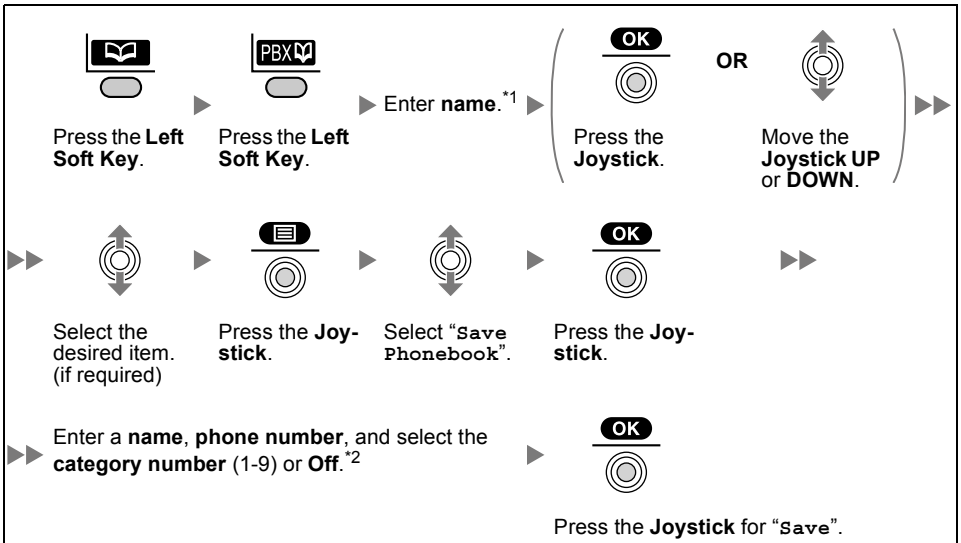

\*1 This step can be omitted.

\*2 Press to confirm each entry. (**name**: max. 16 characters/**phone number**: 32 digits)

- To search for an item in the Phonebook, see page 24.

## Storing an Item Using the PBX Extension Phonebook

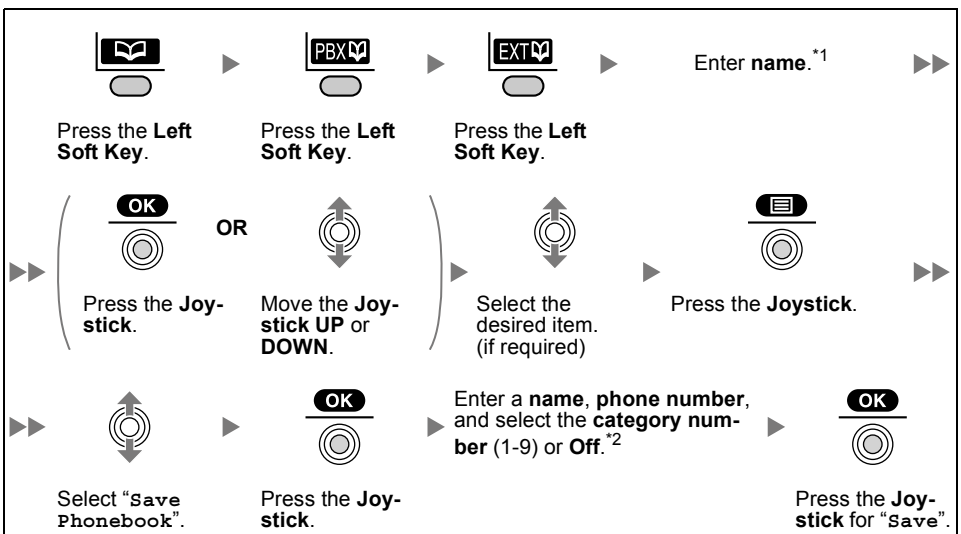

\*1 This step can be omitted.

## Using the Handset Phonebook

- \*2 Press  to confirm each entry. (**name**: max. 16 characters/**phone number**: 32 digits)
- To search for an item in the Phonebook, see page 24.

### Editing Category Names

You can edit the names of the categories in the Handset Phonebook.

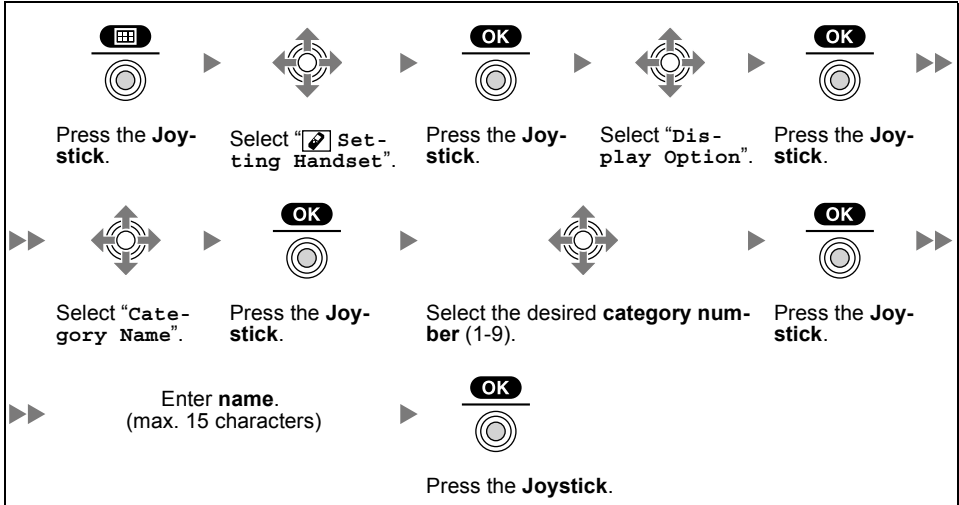



## Assigning Hot Keys

You can assign a phone number stored in the Handset Phonebook to a key to be used as a Hot Key.

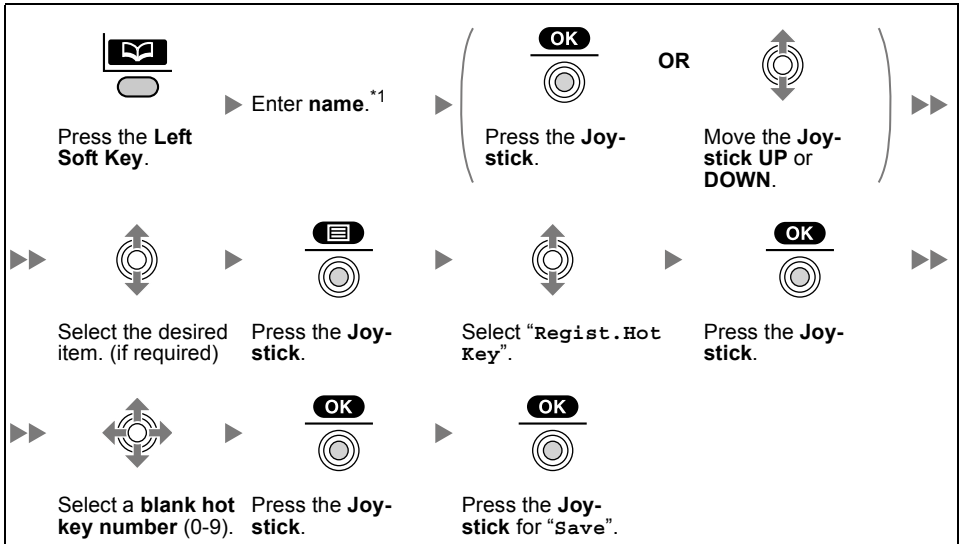

\*1 This step can be omitted.

- To search for an item in the Phonebook, see page 24.
- A "✓" will be displayed next to hot key numbers that have a Phonebook item registered to them.

## Entering Characters

You can enter characters and digits using the dialing keys. You can select one of 3 character modes by pressing the **Right Soft Key** while entering a name. The function icon above the soft key displays the current character mode. See “Character Mode Table” (page 43) for available characters.

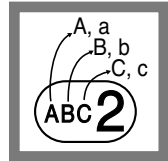

To change the character mode while editing a name in the Phonebook, press the **Right Soft Key**.

Alphabet

ABC



Numeric

0-9



Extended

+ A Â

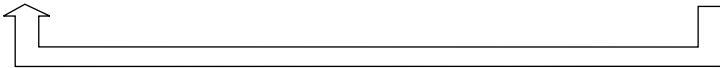













**Example:** To enter “Anne” in Alphabet Mode.



- To switch between uppercase and lowercase, press .
- To enter a character located on the same dialing key as the previous character, move the cursor by moving the Joystick , then enter the desired character.
- If you enter a different character by mistake, move the Joystick to highlight the character, press to delete it, then enter the correct character.
- To clear an entire line, press for more than 1 second.
- To move the cursor, move the Joystick .

**Character Mode Table**

Keys	ABC (Alphabet)	0-9 (Numeric)	+ÅÄ (Extended)
	Space # & ' ( ) * , - . / 1	1	Space # & ' ( ) * , - . / 1
	ABC 2	2	Å Ä Å Ä Å Ä Æ B C Ç 2
	abc 2		a à á â ã ä å æ b c ç 2
	DEF 3	3	DE È É Ê Ë Ì 3
	def 3		de è é ê ë ì 3
	GHI 4	4	G Ğ H I Í Î Ï Ñ 4
	ghi 4		g ğ h i í î ï ñ 4
	JKL 5	5	JKL 5
	jkl 5		jkl 5
	MNO 6	6	M Ñ Ñ O Ó Ô Õ Ö Ø 6
	mno 6		m ñ ñ o ó ô õ ö ø 6
	PQRS 7	7	PQRS Ş ß 7
	pqrs 7		pqrs ş ß 7
	TUV 8	8	TU Ù Ú Û Ü Û V 8
	tuv 8		tu ù ú û ü ù v 8
	WXYZ 9	9	W Ŵ XY ŷ Z 9
	wxyz 9		w ŵ xy ŷ z 9
	Space 0	0	Space 0

- Press  before or after entering a character to change between uppercase and lowercase.
- Pressing a key repeatedly will cycle through the characters associated with that key. For example, to enter the letter “C”, press  three times.

### Locking the Handset Phonebook

You can lock/unlock the Phonebook while the handset is in standby mode.

#### Locking the Handset Phonebook

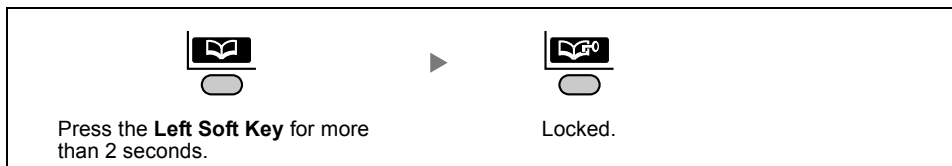

#### Unlocking the Handset Phonebook



#### Unlocking the Handset Phonebook Temporarily

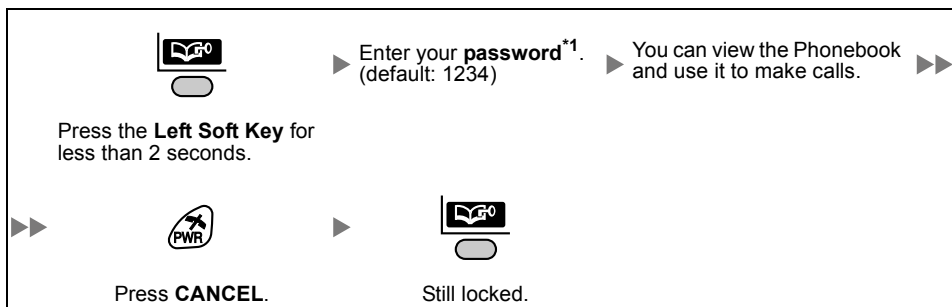

\*1 To change the password, see page 54.

# Deleting Stored Items in Handset Phonebook/Hot Key Dial/Outgoing Call Log/Incoming Call Log

## Handset Phonebook

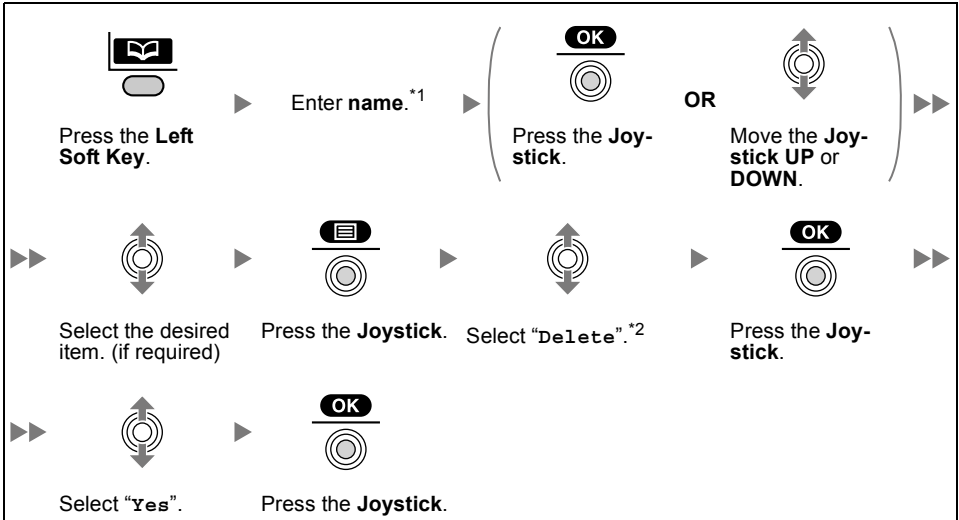

\*1 This step can be omitted.

\*2 Select "**Delete All**" if you want to delete all items.

- To search for an item in the Phonebook, see page 24.

## Hot Key Dial

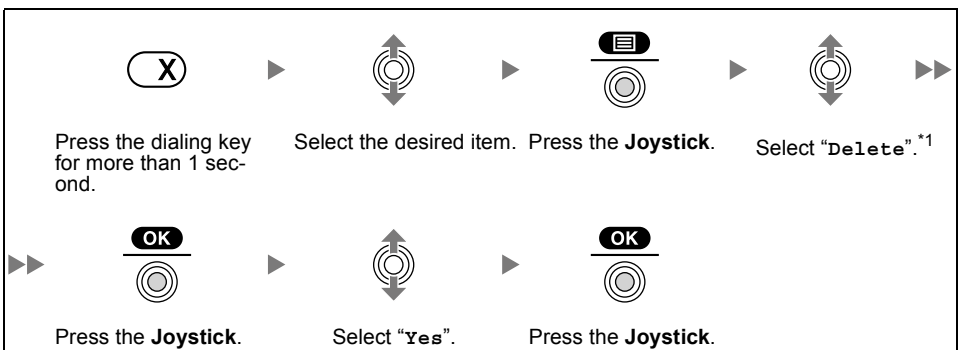

\*1 Select "**Delete All**" if you want to delete all items.

- If you delete a Phonebook item that you also assigned to a Hot Key, the Hot Key Dial is also deleted. (See page 41.)

## Deleting Stored Items

### Outgoing Call Log

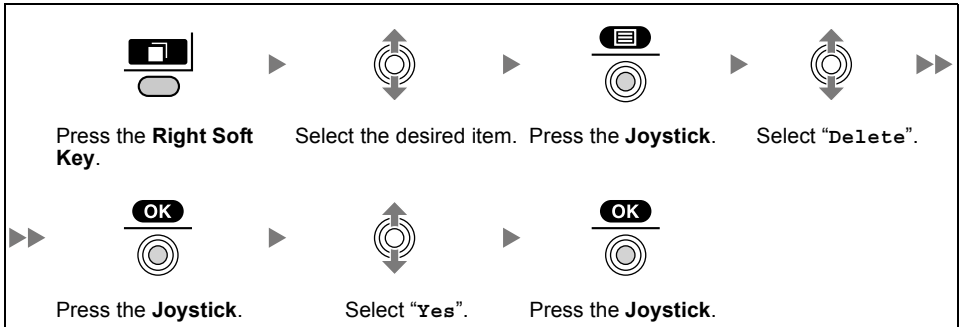

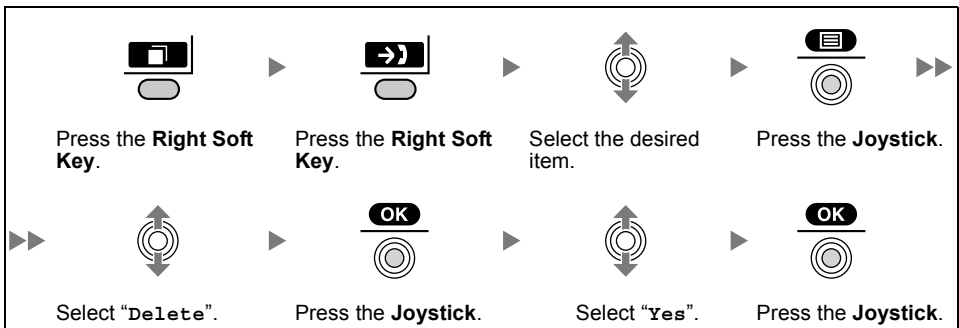

### Incoming Call Log

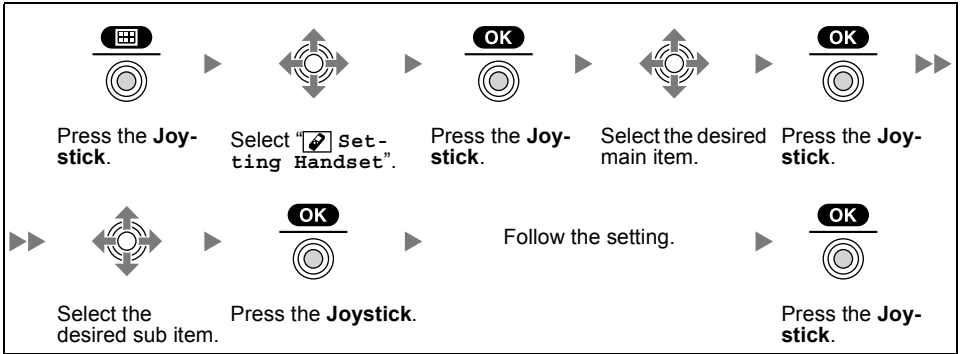

### Changing the Initial Settings

You can customize the handset by editing the settings found under “Setting Handset” in the menu list, as follows:



- To return to the previous menu, press .
- To cancel, press  at any time.
- The handset will beep to indicate that the new settings have been saved.

## Handset Setting Menu Layout

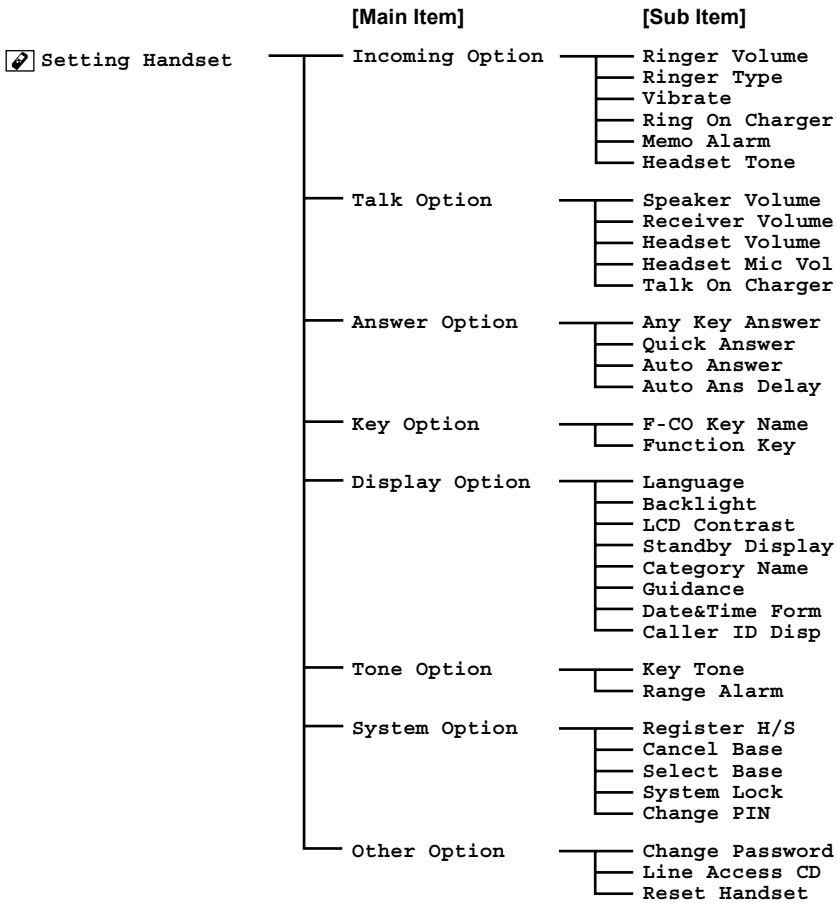



### Incoming Option

Sub Item	Description	Setting	Default
Ringer Volume	Adjusts the ringer volume.	<input type="checkbox"/> Step Up <input type="checkbox"/> Step Down <input type="checkbox"/> Level 1-6 <input type="checkbox"/> Off	Level 3
Ringer Type	<b>Ringer Pattern</b> Selects the ringer pattern for each type of call.	<input type="checkbox"/> Bell 1-6 <input type="checkbox"/> Melody 1-9	Bell 1
– Intercom Ring	<b>LED Pattern</b> Selects the LED pattern for each type of call.	<input type="checkbox"/> Red <input type="checkbox"/> Green <input type="checkbox"/> Orange <input type="checkbox"/> R→G→O	CO Ring: Red Intercom Ring/ Private Ring: Green Group Ring: Orange
– CO Ring			
– Group Ring			
– Private Ring (Category 1-9)	<b>Vib. Pattern</b> Selects the vibrate pattern for each type of call.	<input type="checkbox"/> Single <input type="checkbox"/> Double <input type="checkbox"/> Triple <input type="checkbox"/> Short Double <input type="checkbox"/> Short Triple <input type="checkbox"/> Short Term <input type="checkbox"/> Continuous	Single
Vibrate	Selects whether the handset vibrates while receiving a call.	<input type="checkbox"/> Vib.& Ring <input type="checkbox"/> Vib.→ Ring <input type="checkbox"/> Off	Off
Ring On Charger	Selects the ringing mode (On or Off) while a handset is set on the charger.*1	<input type="checkbox"/> On <input type="checkbox"/> Off	On

## Configuring Handset Settings

Sub Item	Description	Setting	Default
Memo Alarm	<b>Ringer Pattern</b> Selects the ringer pattern for each Memo Alarm.	<input type="checkbox"/> Bell 1-6 <input type="checkbox"/> Melody 1-9	Bell 1
	<b>LED Pattern</b> Selects the LED pattern for each Memo Alarm.	<input type="checkbox"/> Red <input type="checkbox"/> Green <input type="checkbox"/> Orange <input type="checkbox"/> R→G→O	Green
	<b>Vib. Pattern</b> Selects the vibrate pattern for each Memo Alarm.	<input type="checkbox"/> Single <input type="checkbox"/> Double <input type="checkbox"/> Triple <input type="checkbox"/> Short Double <input type="checkbox"/> Short Triple <input type="checkbox"/> Short Term <input type="checkbox"/> Continuous	Single
Headset Tone	Selects whether a tone is heard from the attached headset while receiving a call.	<input type="checkbox"/> On <input type="checkbox"/> Off	Off

\*1 When "Ring On Charger" is set to on but "Ringer Volume" is set to off, the handset rings at level 1.

### Talk Option

Sub Item	Description	Setting	Default
Speaker Volume	Adjusts the rear speaker volume.	Level 1-6	Level 3
Receiver Volume	Adjusts the receiver volume.	Level 1-4	Level 2
Headset Volume	Adjusts the headset speaker volume.	Level 1-4	Level 2
Headset Mic Vol	Adjusts the headset microphone volume.	Level 1-4	Level 1
Talk On Charger	Selects whether or not to continue the conversation when the handset is put on the charger during a conversation.	<input type="checkbox"/> On <input type="checkbox"/> Off	Off

## Configuring Handset Settings

### Answer Option

Sub Item	Description	Setting	Default
Any Key Answer	Answers a call by pressing any dialing key.	<input type="checkbox"/> On <input type="checkbox"/> Off	Off
Quick Answer	Answers a call while charging by just lifting up a handset from the charger.	<input type="checkbox"/> On <input type="checkbox"/> Off	Off
Auto Answer	Selects the types of calls that can be answered by AUTO ANSWER.	<input type="checkbox"/> Int Only <input type="checkbox"/> Int & CO	Int Only
Auto Ans Delay	Selects the number of seconds before a call is automatically answered when Auto Answer is turned on.	0 s-20 s	6 s

### Key Option

Sub Item	Description	Setting	Default
F-CO Key Name	Edits the names of the flexible CO keys.	Max. 12 characters x 12 flexible CO keys x 4 bases	Not stored
Function Key	Edits Function Key list.	<input type="checkbox"/> Redial <input type="checkbox"/> Fwd/DND <input type="checkbox"/> Flash/Recall <input type="checkbox"/> Auto Answer <input type="checkbox"/> Conference <input type="checkbox"/> Pause <input type="checkbox"/> Auto Dial <input type="checkbox"/> PBX Program <input type="checkbox"/> None* <sup>1</sup>	1: Redial 2: Fwd/DND 3: Flash/Recall 4: Auto Answer 5: Conference 6: Pause 7: Auto Dial 8: None 9: None 0: PBX Program

\*1 Used to cancel the settings.

## Configuring Handset Settings

### Display Option

Sub Item	Description	Setting	Default
Language	Selects the display language.	<input type="checkbox"/> Auto <input type="checkbox"/> English <input type="checkbox"/> Español <input type="checkbox"/> FRANÇAIS	Auto
Backlight	Turns on the backlight of the LCD and keypad.	<input type="checkbox"/> On <input type="checkbox"/> On & Receiving <input type="checkbox"/> Off	On
LCD Contrast	Adjusts the LCD contrast.	Level 1-5	Level 3
Standby Display	Selects the display in standby mode.	<input type="checkbox"/> H/S No. <input type="checkbox"/> Base & H/S No. <input type="checkbox"/> Edit	H/S No.
	Edits the name displayed on the LCD while in standby mode.	Max. 16 characters/4 digits	Not stored
Category Name	Edits the names of the categories.	Max. 15 characters x Category (1-9)	Not stored
Guidance	Selects whether the guidance display is shown or not in standby mode.	<input type="checkbox"/> On <input type="checkbox"/> Off	On
Date&Time Form	Selects the format for the date shown on the display in standby mode.	<input type="checkbox"/> DD-MM 12H <input type="checkbox"/> DD-MM 24H <input type="checkbox"/> MM-DD 12H <input type="checkbox"/> MM-DD 24H <input type="checkbox"/> DD-MM-YY <input type="checkbox"/> MM-DD-YY	MM-DD 12H
Caller ID Disp	Selects which caller information is displayed when a call is received. Either the information stored in the Handset Phonebook or the PBX can be displayed.	<input type="checkbox"/> H/S Phonebook <input type="checkbox"/> PBX Setting	PBX Setting

### Tone Option

Sub Item	Description	Setting	Default
Key Tone	Turns the key tone on or off.	<input type="checkbox"/> On <input type="checkbox"/> Off	On
Range Alarm	Selects whether the range alarm tone rings or not.	<input type="checkbox"/> On <input type="checkbox"/> Off	On

### System Option

Sub Item	Description	Setting	Default
Register H/S	Registers a handset to a base.	Base 1-4	Not stored
Cancel Base <sup>*1</sup>	Cancels the registration of a handset.	Base 1-4 <sup>*2</sup>	
Select Base <sup>*1</sup>	Selects a base.	<input type="checkbox"/> Auto <input type="checkbox"/> Base 1-4	Auto
System Lock	Selects whether to lock the System Option set or not.	<input type="checkbox"/> On <sup>*3</sup> <input type="checkbox"/> Off	Off
Change PIN	Before registering your handset with a PBX, enter the PBX's PIN here. Once you have registered the handset with a PBX, this PIN can be changed so that the handset can be registered to an additional PBX.	Enter the PIN number. (max. 8 digits)	1234

\*1 Only registered base is shown.

\*2 You can select multiple bases simultaneously.

\*3 Password is required. (4 digits)

## Configuring Handset Settings

### Other Option

Sub Item	Description	Setting	Default
Change Password	Changes the handset password (4 digits) used for unlocking the Handset Phonebook and using the "Reset Handset" option.	Enter Old Password. ↓ Enter New Password. ↓ Verify New Password.	1234
Line Access CD	Enters the line access code that matches the setting of your PBX. Three access line codes can be stored.	Select a number, then enter the code. (max. 6 digits)	No.1: 9 No.2: 8XX* <sup>1</sup> No.3: Not Stored
Reset Handset	Returns the handset settings to its default settings.	Enter Password. (4 digits) ↓ Select the desired item(s). ↓ Press "OK".	Not stored

\*1 XX is identical to the CO line group number, and 8XX represents any 3-digit code starting with "8".

## Memo Alarm Setting

An alarm will sound at the set time. A memo can also be displayed. Memo Alarm is available only when handset is within range of a CS.

### To set

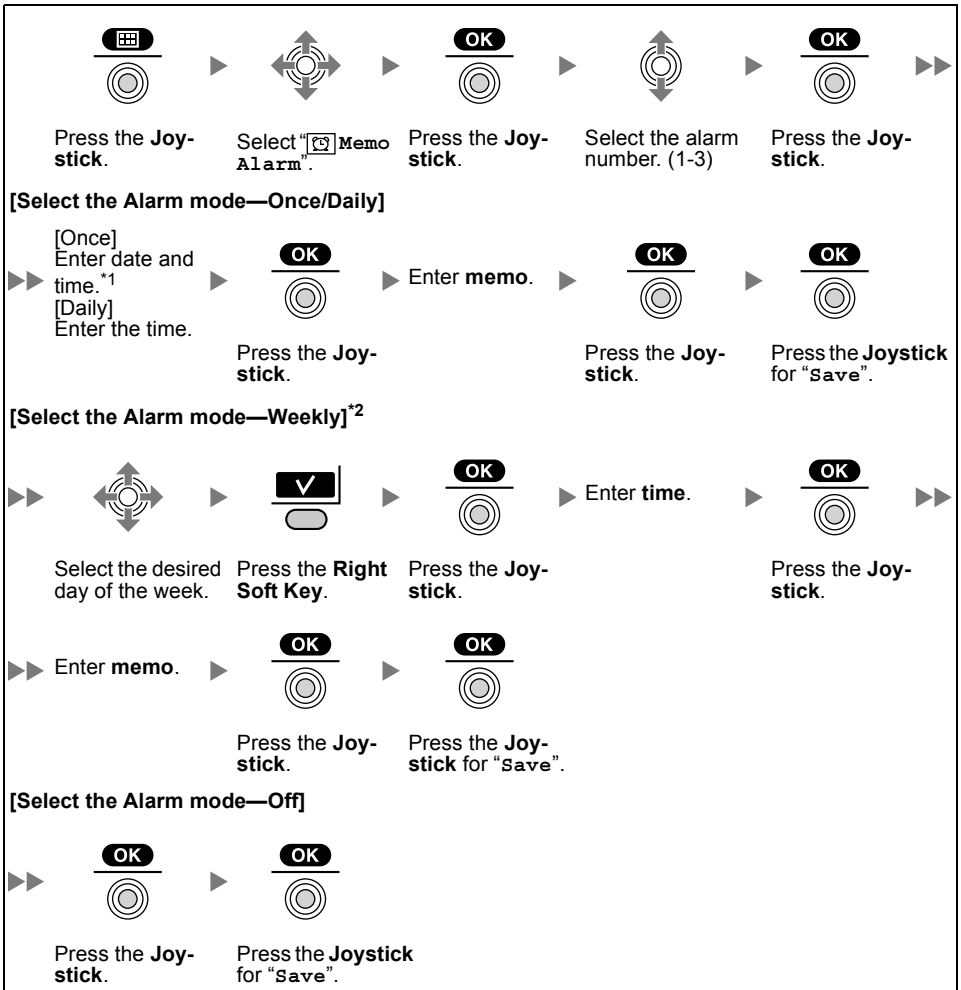

\*1 You can select the format for the date and time. (See page 52.)

\*2 A "✓" will be displayed next to a day of the week that have been set.

- You can select the ringer/LED/vibrate pattern for each Memo Alarm. (See page 50.)
- If you are on a call at the time that the alarm is set to sound, it will sound after you have ended the call.

## Configuring Handset Settings

### To delete the alarm mode setting

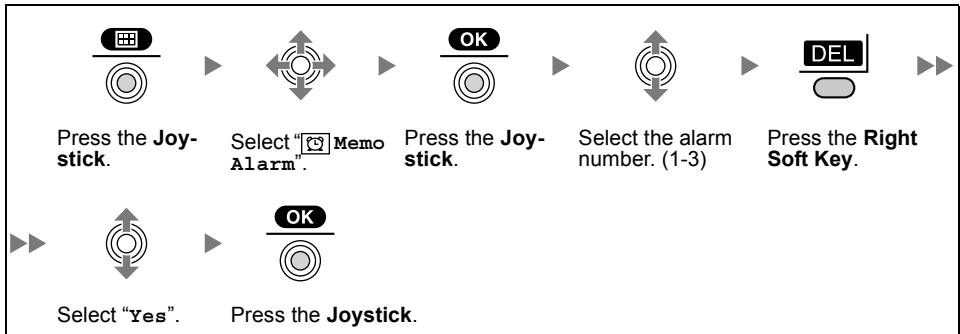

### To stop the alarm

Press all keys other than soft keys.



# Troubleshooting

Problem	Possible Cause	Solution
The handset does not work.	The battery is drained.	Charge the battery fully. (See "Charging the Battery" on page 5.)
	The power is OFF.	<ul style="list-style-type: none"> <li>• Turn it ON. (See "Location of Controls" on page 7.)</li> <li>• Re-insert the battery and try again. (See "Battery Installation" on page 5.)</li> </ul>
The handset does not ring.	Ringer volume is set to "OFF".	Adjust the ringer volume level. (See "Adjusting the Ringer Volume" on page 12.)
You cannot make/receive a call.	The handset is out of range, or the CS is busy.	Move closer to the CS or try again later.
	The radio channel is busy, or a radio communication error occurred.	Try again later.
You cannot dial.	The number that you dialed is restricted by the PBX.	Consult your dealer.
	Key lock mode is ON.	To cancel the mode, press the Joystick for about 2 seconds. (See "Key Lock" on page 8.)
	The radio channel is busy or a radio communication error occurred.	Try again later.
The handset stops working during operation.		<ul style="list-style-type: none"> <li>• Turn the handset off, then turn it back on. (See "Location of Controls" on page 7.)</li> <li>• Re-insert the battery and try again. (See "Battery Installation" on page 5.)</li> </ul>
You cannot use the handset during a power failure.	The handset will not function during a power failure because the PBX stops emitting radiowaves.	
The headset does not work.	A headset tone cannot be heard when receiving an incoming call when the headset is attached.	<ul style="list-style-type: none"> <li>• Make sure the headset tone setting is set to on. (See "Incoming Option" on page 49.)</li> <li>• Make sure the headset jack is connected properly. (See "Location of Controls" on page 7.)</li> </ul>
The tone from the headset cannot be changed to a bell or melody.	The headset tone is a specific tone and is not related to the Incoming Option settings (Ringer Type).	
Noise is frequently heard.		<ul style="list-style-type: none"> <li>• Set the handset and CS away from other electrical appliances.</li> <li>• Move closer to the CS.</li> </ul>

## Troubleshooting and Error Messages

Problem	Possible Cause	Solution
Two short beeps are heard during a conversation.	The radio signal is weak.	Move closer to the CS.
The charge indicator flashes red rapidly.	The charger is not connected properly.	<ul style="list-style-type: none"><li>• Make sure the battery is inserted properly.</li><li>• Set the handset in the charger properly.</li></ul>
You charged the battery for 7 hours, but the beep tones sound, and <input type="checkbox"/> (needs to be charged) flashes after a few telephone calls.	The battery charge contacts may be dirty.	Clean the battery charge contacts without damaging them and charge once more.
	It is time to change the battery.	Replace with a new one.
While operating the handset, the AC adaptor feels warm. While charging the battery, the handset feels warm.	These are normal conditions.	

### Error Messages

Error Message	Possible Cause	Solution
Register Unit	The handset has been canceled or the handset has not been registered.	Consult your dealer.
No Service	The handset is out of range.	Move closer to the CS.
	The CS is turned off.	Make sure the power cord is connected.
PS Not Connected	The called handset is out of range or is not turned on.	Try again later.
CS Busy	The CS is busy.	Try again later.
Please Wait...	The handset is connecting to the CS or PBX.	Wait for a moment.
Charge Battery	The handset battery has little charge remaining.	Charge the battery fully. (See "Charging the Battery" on page 5.)
No Entries	When trying to view the Phonebook: No items have been stored. (See "Storing an Item in the Handset Phonebook" on page 35.) When trying to view the Incoming or Outgoing Call Log: No logs have been stored.	
Memory Full	The Phonebook is full and cannot store the new item.	Remove unnecessary data in the Phonebook and try again.
Incorrect Entry	The numbers you entered are invalid.	Recheck your entry (max. 5 digits) and try again.
Need Repair 1(-2)		Consult your dealer.

### Battery Information

After your Panasonic battery is fully charged (at 25 °C [77 °F]):

Operation	Operating Time
While in use (Talk)	Up to about 10 h
While not in use (Standby)	Up to about 168 h

- Operating time may be shorter than listed above depending on usage conditions and ambient temperature.
- The battery will drain slowly even while the handset is turned off.
- The handset can receive calls while charging.
- Battery consumption increases when the handset is used out of range. If “” flashes, power off the handset.

---

### Low Battery Warning

The battery needs to be charged in the following situations:

- “” flashes, and the alarm sounds\*1.
- “Charge Battery” is displayed. In this situation, the handset cannot be operated.

\*1 If the low battery warning occurs during a conversation, the call will be automatically disconnected one minute after the alarm sounds.

---

### Replacing the Battery

If “” flashes after using the phone for a short time, even when the battery has been fully charged, the battery should be replaced.

Before replacing the battery, make sure the low battery warning is displayed, then turn off the power to prevent memory loss. Replace the battery and charge the new battery for about 7 hours.

If you replace the battery before the low battery warnings appears, the battery strength icon may display an incorrect reading. In this case, use the handset as normal with the new battery installed. When the low battery warning is displayed, charge the battery for about 7 hours. The battery strength icon will then display the correct reading.

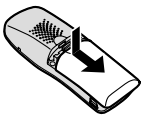

1. Turn the power off to prevent memory loss.
2. Press the notch on the cover firmly and slide it as indicated by the arrow.
3. Open the cover and replace the battery.
4. Close the cover and charge the handset.

- Please use a Panasonic battery with the service part number N4HHGMB00005 or HHR-P103.



This product is powered by a recyclable nickel-metal hydride battery. Please call 1-800-8-BATTERY for information on how to recycle this battery. There is a danger of explosion if the battery is incorrectly replaced.

## **Important Safety Instructions**

When using your telephone equipment, basic safety precautions, including those below, should always be followed to reduce the risk of fire, electric shock and injury to persons.

1. Read and understand all instructions.
2. Follow all warnings and instructions marked on this product.
3. Unplug the charger from the AC outlet before cleaning. Do not use liquid or aerosol cleaners. Clean with a damp cloth.
4. Do not use the product near water, for example, near a bathtub, kitchen sink, or laundry tub, in a wet basement, or near a swimming pool.
5. Place the charger on a stable surface.
6. The product should never be placed near or over a radiator or other heat source.
7. The charger should only be connected to the type of electric power supply specified on the charger label. If you are not sure of the type of power supply to your home, consult your dealer or local power company.
8. Do not allow anything to rest on the power cord. Do not locate the charger where the power cord may be stepped on or tripped on.
9. To reduce the risk of fire or electric shock, do not overload AC outlets and extension cords.
10. Do not insert objects of any kind into this product through openings, as they may touch dangerous voltage points or short out parts that could result in a risk of fire or electric shock. Never spill liquid of any kind on the product.
11. To reduce the risk of electric shock, do not disassemble this product. Only qualified personnel should service this product. Opening or removing covers may expose you to dangerous voltages or other risks. Incorrect reassembly can cause electric shock.
12. Unplug the charger from the AC outlet and have the product serviced by qualified service personnel in the following cases:
  - A. When the power supply cord or plug is damaged or frayed.
  - B. If liquid has been spilled on the product.
  - C. If the product has been exposed to rain or water.
  - D. If the product does not work normally by following this manual. Adjust only controls covered by this manual. Improper adjustment may require repair by an authorized service center.
  - E. If the product has been dropped or damaged.
  - F. If the product's performance deteriorates.
13. Avoid using a wired telephone during an electrical storm. There is a remote risk of electric shock from lightning.
14. Do not use the telephone in the vicinity of a gas leak to report the leak.
15. When you operate this product, the AC outlets should be near the product and easily accessible.

**SAVE THESE INSTRUCTIONS**

## ***Important Information***

---

### **CAUTION**

To reduce the risk of fire or injury to persons, read and follow these instructions.

1. Use only the AC adaptor, battery and charger indicated in this manual.
2. Do not dispose of the battery in a fire. They may explode. Check with local authorities for special disposal instructions.
3. Do not open or disassemble the battery. Released electrolyte is corrosive and may cause burns or injury to the eyes or skin. The electrolyte is toxic if swallowed.
4. Exercise care in handling batteries in order not to short the battery to conductive materials such as rings, bracelets, and keys. The battery and/or conductor may overheat and cause burns.
5. Charge the battery provided with, or identified for use with, this product only in accordance with the instructions and limitations specified in this manual.
6. There is a danger of explosion if the battery is incorrectly replaced.

Any changes or modifications not expressly approved by the party responsible for compliance could void the user's authority to operate this product.

### **WARNING**

**TO PREVENT POSSIBLE FIRE OR ELECTRIC SHOCK, DO NOT EXPOSE THIS PRODUCT TO RAIN OR MOISTURE.**

Unplug the charger from AC outlets if it emits smoke, an abnormal smell or makes unusual noise. These conditions can cause fire or electric shock. Confirm that smoke has stopped and contact an authorized service center.

When programming emergency numbers and/or making test calls to emergency numbers:

1. Remain on the line and briefly explain to the dispatcher the reason for the call before hanging up.
2. Perform such activities during off-peak hours, such as early morning or late evening.

## **FCC Information**

Privacy of communications cannot be ensured when using this phone.

### **Radio Frequency Exposure Requirements**

This product complies with FCC radiation exposure limits set forth for an uncontrolled environment. To comply with FCC RF exposure requirements, it must be installed and operated in accordance with provided instructions. For handset body-worn operation, this handset must be used with the provided plastic belt clip, which assures no metal parts and minimum of 1.5 cm (9/16 in) spacing from the user's body. This transmitter must not be co-located or operated in conjunction with any other antenna or transmitter.

### **Note**

This equipment has been tested and found to comply with the limits for a Class B digital device, pursuant to Part 15 of the FCC Rules. These limits are designed to provide reasonable protection against harmful interference in a residential installation. This equipment generates, uses, and can radiate radio frequency energy and, if not installed and used in accordance with the instructions, may cause harmful interference to radio communications. However, there is no guarantee that interference will not occur in a particular installation. If this equipment does cause harmful interference to radio or television reception, which can be determined by turning the equipment off and on, the user is encouraged to try to correct the interference by one or more of the following measures:

- Reorient or relocate the receiving antenna.
- Increase the separation between the equipment and receiver.
- Connect the equipment to an outlet on a circuit different from that to which the receiver is connected.
- Consult the dealer or an experienced radio/TV technician for help.

This device complies with Part 15 of the FCC Rules. Operation is subject to the following two conditions:

(1) this device may not cause harmful interference, and (2) this device must accept any interference received, including interference that may cause undesired operation.

Using this telephone near 2.4 GHz electrical appliances may cause interference to one or both devices. Move away from the electrical appliances.

## ***Important Information***

---

### **Customer Information**

This equipment complies with Part 68 of the FCC rules and the requirements adopted by the ACTA. On the inside of the battery compartment of this equipment is a label that contains, among other information, the following product identifier:

*US: ACJKXNANKX-TD7694*

If requested, this number must be provided to the telephone company.

If trouble is experienced with this equipment KX-TD7694, for repair or warranty information, please contact:

Panasonic Service and Technology Company  
BTS Center  
1225 Northbrook Parkway Suite  
1-216 Suwanee  
GA 30024

If the equipment is causing harm to the telephone network, the telephone company may request that you disconnect the equipment until the problem is resolved.

### **Hearing Aid Compatibility**

This telephone provides magnetic coupling for hearing aids as defined by the FCC in 47 CFR Section 68.316. Use only handsets or other acoustic devices with this equipment that are compliant with the hearing aid compatibility requirements of FCC Part 68.

When you hold the phone to your ear, noise might be heard in your Hearing Aid. Some Hearing Aids are not adequately shielded from external RF (radio frequency) energy. If noise occurs, use an optional headset accessory or the speakerphone option (if applicable) when using this phone. Consult your audiologist or Hearing Aid manufacturer about the availability of Hearing Aids which provide adequate shielding to RF energy commonly emitted by digital devices.



---

---

## **Other Important Information**

**Environment**—do not place the product in rooms where the temperature is less than 5 °C (41 °F) or greater than 40 °C (104 °F). Allow 10 cm (3-15/16 in) clearance around the product for proper ventilation.

Avoid environments with excessive smoke, dust, mechanical vibration, shock, or direct sunlight.

**Medical**—consult the manufacturer of any personal medical devices, such as pacemakers, to determine if they are adequately shielded from external RF (radio frequency) energy. (The product operates in the frequency range of 2,401 MHz to 2,480 MHz and emits 0.40 watts of RF [radio frequency] power.) Do not use the product in health care facilities if any regulations posted in the area instruct you not to do so. Hospitals or health care facilities may be using devices sensitive to external RF (radio frequency) energy.

**Routine Care**—wipe the product with a soft cloth. Do not clean the product with abrasive powder or with chemical agents such as benzene or thinner. Clean the terminal of the charger periodically. When you leave the product unused for a long period of time, unplug the AC adaptor from the outlet.

### **For Product Service**

- Panasonic Service Centers are listed in the service center directory.
- Call 1-800-211-PANA (7262) for the location of your nearest authorized service center.
- Panasonic's e-mail address for customer inquiries:  
consumerproducts@panasonic.com  
for customers in the USA or Puerto Rico ONLY

### **To return a product for repair**

Carefully pack and send it prepaid, adequately insured and preferably in the original carton. Attach a postage-paid letter, detailing the symptom, to the outside of the carton. DO NOT send the product to the Executive or Regional Sales offices, as they are not equipped to make repairs.

### **Product Service**

Panasonic Factory Service Centers for this product are listed in the service center directory. Consult your certified Panasonic dealer for detailed instructions.

- This cordless telephone is designed for use in the United States of America. Sale or use of this product in other countries may violate local laws.
- Ce téléphone sans fil est conçu pour être utilisé aux États-Unis d'Amérique. La vente ou l'emploi de cet appareil dans certains autres pays peut constituer une infraction à la législation locale.
- Este teléfono sin cordón fue elaborado para su uso en los Estados Unidos de América. La venta o el empleo de este producto en ciertos países puede constituir una violación de la legislación local.
- このコードレス電話機は、日本国外での使用を目的として設計されており、日本国内での使用は法律違反となります。従って、当社では日本国内においては原則として修理などのサービスは致しかねます。

## Important Information

---

### For Best Performance

#### Operating Range

1. The range of operation depends on the topography of your office, weather, or usage conditions, because signals are transmitted between the CS and the handset by radio waves.
2. Normally, you get greater range outdoors than indoors. If there are obstacles such as walls, noise may interfere with your telephone calls. In particular, high metal shelves or reinforced concrete walls will restrict your operating range.
3. A handset may not work when it is too far from the CS depending on the structure of the building.

#### Noise

Occasional noise or interference may occur due to electromagnetic radiation from objects such as refrigerators, microwave ovens, faxes, TVs, radios, or personal computers. If noise disturbs your telephone calls, keep the handset away from these electrical appliances.

We strongly suggest you hold the bottom half of the handset to ensure better call quality. Because, the antenna is located in the upper half of the handset.

---

### System Requirements

PBX		CS
Model No.	Main Processing (MPR) Software Version	
KX-TDA50 KX-TAW848	PSMPR Software File Version 3.0005 or later	KX-T0151 KX-TDA0152 KX-T0141 KX-TDA0142
KX-TDA100 KX-TDA200	PMPR Software File Version 3.0002 or later	
KX-TDA600	PLMPR Software File Version 3.1006 or later	
KX-TDE100 KX-TDE200	PMMPR Software File Version 1.0000 or later	



For your future reference

SERIAL NO. \_\_\_\_\_

(found inside the battery compartment)

DATE OF PURCHASE \_\_\_\_\_

NAME OF DEALER \_\_\_\_\_

DEALER'S ADDRESS \_\_\_\_\_

\_\_\_\_\_

\_\_\_\_\_

\_\_\_\_\_

DEALER'S TEL. NO. \_\_\_\_\_

**Panasonic Consumer Electronics Company,  
Division of Panasonic Corporation of North America**

One Panasonic Way, Secaucus, New Jersey 07094

**Panasonic Puerto Rico, Inc.**

San Gabriel Industrial Park, Ave. 65 de Infantería, Km. 9.5,  
Carolina, Puerto Rico 00985

<http://www.panasonic.com/csd>

**Copyright:**

This material is copyrighted by Panasonic Communications Co., Ltd., and may be reproduced for internal use only. All other reproduction, in whole or in part, is prohibited without the written consent of Panasonic Communications Co., Ltd.

© 2007 Panasonic Communications Co., Ltd. All Rights Reserved.

**PSQX4318ZA** KK0607SY0