

# 140CR

## Electronic Cash Register



(140CR small drawer model)

### User's Manual

***START-UP is QUICK and EASY!***

***Simple to use!***

20 departments and 120 PLUs

Automatic Tax Calculations

Calculator function



CASIO COMPUTER CO., LTD.

6-2, Hon-machi 1-chome

Shibuya-ku, Tokyo 151-8543, Japan

**CASIO®** 

Thank you very much for purchasing this CASIO electronic cash register.

START-UP is QUICK and EASY!

Part-1 of this User's Manual can help you make a quick start.

Once you have mastered the QUICK START operations, you will undoubtedly want to expand your use of this machine by studying other sections of Part-2.

### **Original Carton/Package**

If for any reason, this product is to be returned to the store where purchased, it must be packed in the original carton/package.

### **Location**

Locate the Cash register on a flat, stable surface, away from heaters or areas exposed to direct sunlight, humidity or dust.

### **Power Supply**

Your cash register is designed to operate on standard household current (120V, 220V, 230V or 240V; 50/60Hz). Do not overload the outlet by plugging in too many appliances.

### **Cleaning**

Clean the cash register exterior with a soft cloth which has been moistened with a solution of a mild neutral detergent and water, and wrung out.

Be sure that the cloth is thoroughly wrung out to avoid damage to the printer.

Never use paint thinner, benzene, or other volatile solvents.

The mains plug on this equipment must be used to disconnect mains power. Please ensure that the socket outlet is installed near the equipment and shall be easily accessible.

## Safety precautions

- To use this product safely and correctly, read this manual thoroughly and operate as instructed. After reading this guide, keep it close at hand for easy reference. Please keep all informations for future reference.
- Always observe the warnings and cautions indicated on the product.

## About the icons

In this guide various icons are used to highlight safe operation of this product and to prevent injury to the operator and other personnel and also to prevent damage to property and this product. The icons and definitions are given below.



Indicates that there is a risk of severe injury or death if used incorrectly.



Indicates that injury or damage may result if used incorrectly.

## Icon examples

To bring attention to risks and possible damage, the following types of icons are used.



The  $\triangle$  symbol indicates that it includes some symbol for attracting attention (including warning). In this triangle the actual type of precautions to be taken (electric shock, in this case) is indicated.



The  $\otimes$  symbol indicates a prohibited action. In this symbol the actual type of prohibited actions (disassembly, in this case) will be indicated.



The  $\bullet$  symbol indicates a restriction. In this symbol the type of actual restriction (removal of the power plug from an outlet, in this case) is indicated.

## ⚠ Warning!

### Handling the register



Should the register malfunction, start to emit smoke or a strange odor, or otherwise behave abnormally, immediately shut down the power and unplug the AC plug from the power outlet. Continued use creates the danger of fire and electric shock.

- Contact CASIO service representative.



Do not place containers of liquids near the register and do not allow any foreign matter to get into it. Should water or other foreign matter get into the register, immediately shut down the power and unplug the AC plug from the power outlet. Continued use creates the danger of short circuit, fire and electric shock.

- Contact CASIO service representative.



Should you drop the register and damage it, immediately shut down the power and unplug the AC plug from the power outlet. Continued use creates the danger of short circuit, fire and electric shock.

- Attempting to repair the register yourself is extremely dangerous. Contact CASIO service representative.



Never try to take the register apart or modify it in any way. High-voltage components inside the register create the danger of fire and electric shock.

- Contact CASIO service representative for all repair and maintenance.

### Power plug and AC outlet



Use only a proper AC electric outlet. Use of an outlet with a different voltage from the rating creates the danger of malfunction, fire, and electric shock. Overloading an electric outlet creates the danger of overheating and fire.



Make sure the power plug is inserted as far as it will go. Loose plugs create the danger of electric shock, overheating, and fire.

- Do not use the register if the plug is damaged. Never connect to a power outlet that is loose.

## INTRODUCTION

### Warning!



Use a dry cloth to periodically wipe off any dust built up on the prongs of the plug. Humidity can cause poor insulation and create the danger of electric shock and fire if dust stays on the prongs.



Do not allow the power cord or plug to become damaged, and never try to modify them in any way. Continued use of a damaged power cord can cause deterioration of the insulation, exposure of internal wiring, and short circuit, which creates the danger of electric shock and fire.

- Contact CASIO service representative whenever the power cord or plug requires repair or maintenance.

### Caution!



Do not place the register on an unstable or uneven surface. Doing so can cause the register — especially when the drawer is open — to fall, creating the danger of malfunction, fire, and electric shock.



Do not place the register in the following areas.

- Areas where the register will be subject to large amounts of humidity or dust, or directly exposed to hot or cold air.
- Areas exposed to direct sunlight, in a close motor vehicle, or any other area subject to very high temperatures.

The above conditions can cause malfunction, which creates the danger of fire.



Do not overlay bend the power cord, do not allow it to be caught between desks or other furniture, and never place heavy objects on top of the power cord. Doing so can cause short circuit or breaking of the power cord, creating the danger of fire and electric shock.



Be sure to grasp the plug when unplugging the power cord from the wall outlet. Pulling on the cord can damage it, break the wiring, or cause short, creating the danger of fire and electric shock.



Never touch the plug while your hands are wet. Doing so creates the danger of electric shock. Pulling on the cord can damage it, break the wiring, or cause short, creating the danger of fire and electric shock.



At least once a year, unplug the power plug and use a dry cloth or vacuum cleaner to clear dust from the area around the prongs of the power plug.

Never use detergent to clean the power cord, especially power plug.



Keep small parts out of the reach of small children to make sure it is not swallowed accidentally.

# Contents

Getting to know your cash register .....	6
Daily Job Flow .....	8
<b>Part-1 QUICK START OPERATION .....</b>	<b>9</b>
(You can operate this ECR on a basic level by reading the following sections)	
1. Initialization .....	9
2. Loading Paper .....	10
3. Basic Programming for QUICK START – TIME/DATE .....	11
4. Basic Operation after Basic Programming .....	13
5. Daily Management Report .....	17
<b>Part-2 CONVENIENT OPERATION .....</b>	<b>19</b>
(Please keep these sections to expand your use.)	
1. Various Programming .....	19
2. Various Operations .....	30
<b>Part-3 CALCULATOR FUNCTION .....</b>	<b>36</b>
1. Calculator Mode .....	36
<b>Part-4 USEFUL INFORMATION .....</b>	<b>38</b>
1. Troubleshooting .....	38
2. Specifications .....	38

## Basic Components and Accessories

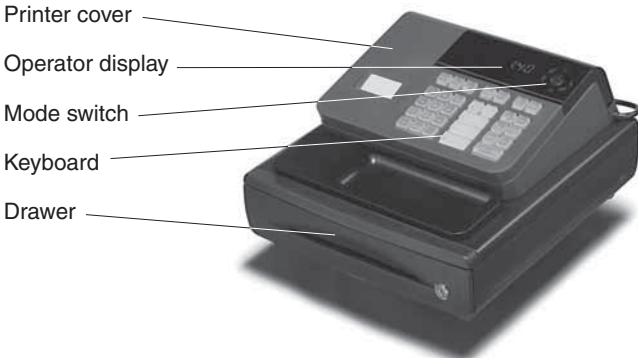

(140CR small drawer model)

<b>Accessories</b>	
Roll paper	1 pc
Mode keys	
Drawer keys	2 pcs
User's manual	1 pc
Fixing hook	
(M drawer model only)	2 pcs
Magnetic plate*	1 pc

\* Use this plate for tacking the notes received from customer.

**Weld lines**  
 Lines may be visible on the exterior of the product. These are "weld lines" that result from the plastic molding process. They are not cracks or scratches.

# Getting to know your cash register

## Mode Switch

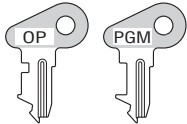
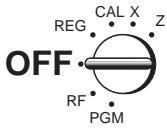

OP key    PGM key

**Note:**

An error is generated (E01 displayed) whenever the position of the Mode Switch is changed during registration.

The position of the Mode Switch controls the type of operations you can perform on the cash register. The PROGRAM key (marked PGM) can select any Mode Switch setting, while OPERATOR key (marked OP) can be used to select OFF, REG or CAL only.



**OFF**

In this position, the power of the cash register is off.

**REG (Register)**

This is the position used for registration of normal transactions.

**RF (Refund)**

This is the position used for registration of refunds.

**CAL (Calculator)**

This is the position used for calculator mode.

**PGM (Programming)**

This is the position used to program the cash register to suit the needs of your store.

**X (Read)**

This is the position used to produce reports of daily sales totals without clearing the totals.

**Z (Reset)**

This is the position used to produce reports of daily sales totals. This setting clears the totals.

## Display

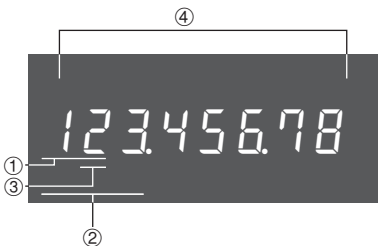

**① Department Number Display**

Anytime you press a department key to register a unit price, the corresponding department number appears here.

**② PLU Number Display**

Anytime you perform a PLU registration, the corresponding PLU number appears here.

**③ Number of Repeat Display**

Anytime you perform "repeat registration" (page 13), the number of repeats appears here. Note that only one digit is displayed for the number of repeats.

**④ Numeric Display**

Entered values (unit prices or quantities) and calculated values (subtotals, totals or change amount due) are displayed here. The capacity of the display is 8 digits.

This part of the display can be used to show the current time or date between registrations (page 33).

## Keyboard

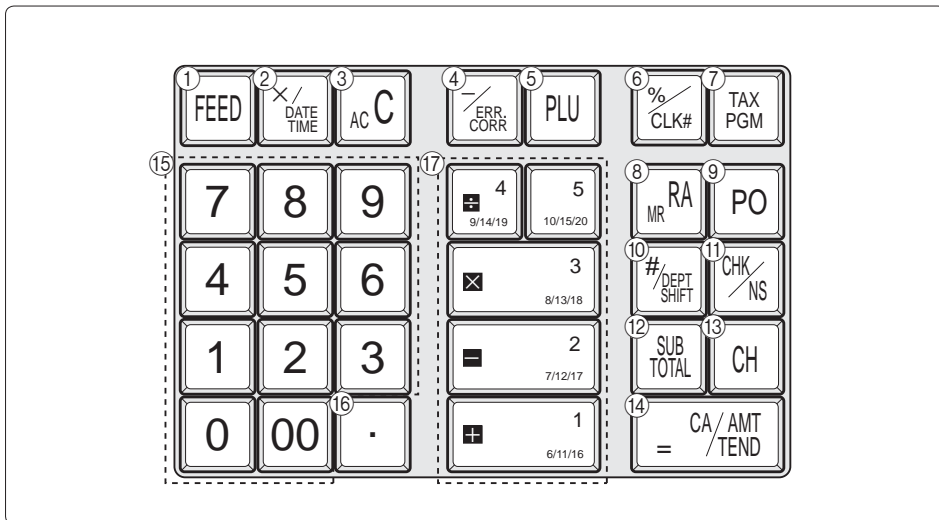

Certain keys have two functions; one for register mode and one for calculator mode. In this manual, we will refer to specific keys as noted below to make the operations as easy to understand as possible:

### Register Mode

- ① **FEED** Feed key
- ②  **$\times$  / DATE TIME** Multiplication/ Date Time key
- ③ **AC C** Clear key
- ④  **$-$  / ERR. CORR** Minus/ Error Correction key
- ⑤ **PLU** PLU (Price Look Up) key
- ⑥ **% / CLK#** Percent/Cashier ID No. Assignment key
- ⑦ **TAX PGM** Tax Program key
- ⑧ **RA / MR** Received on Account key
- ⑨ **PO** Paid Out key
- ⑩ **# / DEPT SHIFT** Reference Number/Department Shift key
- ⑪ **CHK / NS** Check/No Sale key
- ⑫ **SUB TOTAL** Subtotal key
- ⑬ **CH** Charge key
- ⑭ **= CA / AMT TEND** Cash Amount Tendered key
- ⑮ **0, 1, ~ 9, 00** Numeric keys and 2-zero key
- ⑯ **.** Decimal key

- ⑰ **+1, -2,  $\times$ 3, +4, 5** Department keys

- Department 6 through 20 are specified by pressing the **# / DEPT SHIFT** key respectively as follows:
- # / DEPT SHIFT +1** ~ **# / DEPT SHIFT 5** → Department 6 ~ 10
- # / DEPT SHIFT # / DEPT SHIFT +1** ~ **# / DEPT SHIFT # / DEPT SHIFT 5** → Department 11 ~ 15
- # / DEPT SHIFT # / DEPT SHIFT # / DEPT SHIFT +1** ~ **# / DEPT SHIFT # / DEPT SHIFT # / DEPT SHIFT 5** → Department 16 ~ 20

### Calculator Mode

- ③ **AC C** AC key
- ⑥ **% / CLK#** Percent key
- ⑧ **RA / MR** Memory Recall key
- ⑪ **CHK / NS** Drawer Open key
- ⑭ **= CA / AMT TEND** Equal key
- ⑮ **0, 1, ~ 9, 00** Numeric keys and 2-zero key
- ⑯ **.** Decimal key
- ⑰ **+1, -2,  $\times$ 3,  $\div$ 1** Arithmetic Operation key

# Daily Job Flow



## Before Opening The Store

1. Plugged in? Page-10
2. Enough Roll Paper? Page-33
3. Date and Time is correct? Page-33
4. Enough small change in the drawer? Page-34

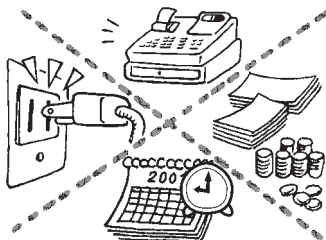

## While The Store Is Open

1. Registrations. Page-13 ~
2. Issuing latest daily sales total if needed. (Generating report by Mode Switch to X position.) Page-17



## After Closing The Store

1. Issuing Daily Sales Total. (Resetting report by Mode Switch to Z position.) Page-17
2. Picking up money in the drawer. Page-34
3. Turn the Mode Switch to OFF.



## Other

1. Troubleshooting Page-38





## QUICK START OPERATION

### 1. Initialization / Loading Memory Protection Battery

#### **Important**

You must initialize the Cash register.

#### **▶ To initialize the cash register**

1. Set the Mode Switch to OFF.
2. Load the memory protection batteries.
3. Plug the power cord of the cash register into an AC outlet.
4. Set the Mode Switch to REG.

**Note:** To prevent to lose all of your settings and sales data, we reccomend you to install the memory protection batteries.

#### **▶ To load the memory protection batteries**

1. Remove the printer cover.
2. Open the battery compartment cover.
3. Load 3 new UM-3, or R6P (SUM-3) type batteries into the compartment. Be sure that the plus (+) and minus (-) ends of each battery are facing in the directions indicated by the illustrations inside the battery compartment (Figure 1).
4. Replace the memory protection battery compartment cover back into place.
5. Replace the printer paper and printer cover.



(Figure 1)

**REPLACE MEMORY PROTECTION BATTERIES AT LEAST ONCE EVERY YEAR.**

## 2. Loading Paper Roll And Replacing The Printer's Ink Roll

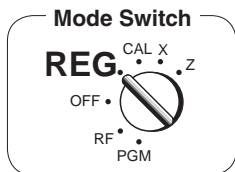

### 1. To load journal paper

- 1 Remove the printer cover by lifting up the back.



- 2 Put a roll of journal paper into the holder.
- 3 Cut the leading end of the roll paper with scissors and insert the paper into the inlet.



- 4 Press the **FEED** key until 20 or 30 cm of paper is fed from the printer.
- 5 Roll the paper onto the take-up reel a few turns.



- 6 Set the left plate of the take-up reel and place the reel into the register.



- 7 Press the **FEED** key to take up any slack in the paper.

- 8 Replace the printer cover by placing the cover's front tab into the register's groove.



### 2. To remove journal paper

- 1 Remove the printer cover following the instructions above.
- 2 Press the **FEED** key until approximately 20cm of the paper is fed from the printer.
- 3 Cut off the roll paper.



- 4 Remove the take-up reel from the printer and take off the left plate of the reel.
- 5 Remove the journal paper from the take-up reel.



- 6 Cut off the paper left in the printer and press the **FEED** key until the remaining paper is fed out from the printer.



- 7 Remove the core of the paper.

- 8 Load new paper following the instructions above, and replace the printer cover.



Default printer setting is for Journal.

To print receipts, please refer to 1-7-3 on page 24 to switch the printer for Receipt or Journal.

### ▶ To load receipt paper



- 1 To use the printer to print receipts, follow steps 1 through 4 of "To load journal paper".
- 2 Pass the leading end of the receipt paper through the printer cover's paper outlet and replace the printer cover.
- 3 Tear off any excess paper.

**Options:** Roll paper – P-5860  
Ink Roll – IR-40

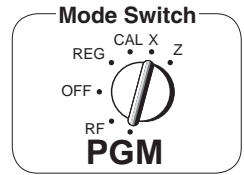
### 3. Basic Programming for QUICK START



Part-1

Procedure	Purpose
1. Turn the mode switch to PGM position.	Programming
2. When the display shows blinking "0", such as  , enter current date in Day, Month, Year order. Example: 8, January, 2010: enter <b>0 8 0 1 1 0</b> • Enter 6-digit, last 2 digits for year set. (2010 → 10) • If you have changed the date order (page-12), enter date of that order. • By pressing <b>AC C</b> , this procedure returns one by one.	Setting the current date
3. When the display shows blinking "0", such as  , enter current time in Hour, Minute order. Example: 1:18 PM, enter <b>1 3 1 8</b> • Enter 4-digit, use 24-hour system. • By pressing <b>AC C</b> , this procedure returns one by one. • If you want to adjust the date/ time, please refer to page 33 of this manual.	Setting the current time
4. Input the desired add-in tax rate to the appropriate department key. (This procedure below programs add-in tax rate only. If you want to set add-on tax or tax with special rounding, refer to page 26 of this manual.) A) Press the <b>TAX PGM</b> key. B) Enter tax rate. (Example: For 6% enter "6", 5.75% enter "5.75".) C) Press the appropriate department key. D) Repeat step B) and C) to set other department key. E) Press the <b>SUB TOTAL</b> key to end tax programming. Note: In case of setting the wrong tax rate to the key, please enter <b>0</b> and press those department keys above, and quit this procedure by pressing <b>SUB TOTAL</b> key, and start from the beginning of this procedure. <b>Example :</b> Set add-in tax 8% to department 2, 3, 15% to department 4 key. <b>TAX PGM</b> Start tax program. <b>8</b> <b>- 2</b> Enter tax rate and press dept key. <b>8</b> <b>x 3</b> Enter tax rate and press dept key. <b>1 5</b> <b>+ 4</b> Enter tax rate and press dept key. <b>SUB TOTAL</b> To end the setting.	Setting the tax rates

Procedure	Purpose																
<p>5. To select the date format and monetary mode (if necessary)</p> <p>You can select the date format and monetary mode after initialization depending on the requirements in your area. Default date format is Day/ Month/ Year and default monetary mode is add 2.</p> <div style="display: flex; align-items: center;"> <div style="margin-right: 20px;"> <p><b>3</b> <small>SUB TOTAL</small></p> <p>P3 appears in mode display</p> <p><b>0 1 2 2</b> <small>SUB TOTAL</small></p> <p>Program set code No.</p> <p>Select number from list A</p> <p>Select number from list B</p> <p>(To end the setting)</p> </div> <div> <table border="1" style="border-collapse: collapse;"> <thead> <tr> <th colspan="2">Date Format Selections</th> </tr> </thead> <tbody> <tr> <td>Year/ Month/ Day</td> <td style="text-align: center;"><b>0</b></td> </tr> <tr> <td>Month/ Day/ Year</td> <td style="text-align: center;"><b>1</b></td> </tr> <tr> <td>Day/ Month/ Year</td> <td style="text-align: center;"><b>2</b></td> </tr> </tbody> </table>   <table border="1" style="border-collapse: collapse;"> <thead> <tr> <th colspan="2">Monetary Mode Selections</th> </tr> </thead> <tbody> <tr> <td>Add 0 (0.)</td> <td style="text-align: center;"><b>0</b></td> </tr> <tr> <td>Add 1 (0.0)</td> <td style="text-align: center;"><b>1</b></td> </tr> <tr> <td>Add 2 (0.00)</td> <td style="text-align: center;"><b>2</b></td> </tr> </tbody> </table> </div> </div>	Date Format Selections		Year/ Month/ Day	<b>0</b>	Month/ Day/ Year	<b>1</b>	Day/ Month/ Year	<b>2</b>	Monetary Mode Selections		Add 0 (0.)	<b>0</b>	Add 1 (0.0)	<b>1</b>	Add 2 (0.00)	<b>2</b>	<p>Select date format and monetary mode</p>
Date Format Selections																	
Year/ Month/ Day	<b>0</b>																
Month/ Day/ Year	<b>1</b>																
Day/ Month/ Year	<b>2</b>																
Monetary Mode Selections																	
Add 0 (0.)	<b>0</b>																
Add 1 (0.0)	<b>1</b>																
Add 2 (0.00)	<b>2</b>																
<p>6. In case of accepting two (the Euro and the local) currencies.</p> <p>6-1. Press the following keys to define the main currency/print out currency of the subtotal.</p> <div style="display: flex; align-items: center;"> <div style="margin-right: 20px;"> <p><b>3</b> <small>SUB TOTAL</small></p> <p>P3 appears in mode display</p> <p><b>2 4 2 2</b> <small>SUB TOTAL</small></p> <p><b>1</b> <small>CA / AMT / TEND</small></p> <p>Euro Status</p> <p>(to end the setting)</p> </div> <div> <p>Euro status</p> <p>(1) Main currency = Local, Print out subtotal = Local: <b>0</b></p> <p>(2) Main currency = Euro, Print out subtotal = Euro : <b>1</b></p> <p>(3) Main currency = Local, Print out subtotal = Both: <b>2</b></p> <p>(4) Main currency = Euro, Print out subtotal = Both : <b>3</b></p> </div> </div> <p>6-2. Press the following keys to set the currency exchange rate against the Euro.</p> <div style="display: flex; align-items: center;"> <div style="margin-right: 20px;"> <p><b>3</b> <small>SUB TOTAL</small></p> <p>P3 appears in mode display</p> <p><b>1 9 9 9</b> <small>SUB TOTAL</small></p> <p><b>1 9 7 7 3</b> <small>CA / AMT / TEND</small></p> <p>Exchange rate (up to 6 digits)</p> <p>Decimal position</p> <p>(to end the setting)</p> </div> <div> <p>Example: (Exchange rate and decimal position)</p> <p>Currency exchange rate = 1 Euro in local currency</p> <p>1 Euro = 1.95583 DM : <b>1 9 5 5 8 3 5</b></p> </div> </div>	<p>Setting the Euro</p>																
<p>7. In case of becoming to accept the Euro only.</p> <p>7-1. You can restrict the registable currency to the Euro only by the following procedure.</p> <ol style="list-style-type: none"> <li>Turn the mode switch to Z position.</li> <li>Issue all reset report including periodic data.</li> <li>Press the following keys to set. <b>0 1 0 7 2 0 0 2</b> <small>SUB TOTAL</small> <small>CA / AMT / TEND</small></li> </ol> <p>If you want to cancel this operation, press <small>SUB TOTAL</small> instead of <small>CA / AMT / TEND</small>.</p>	<p>Restricting the Currency to the Euro</p>																
<p>For Australia only.</p> <p>You can set some programmable options to suit the Australian GST by the following procedure.</p> <ol style="list-style-type: none"> <li>Turn the mode switch to Z position.</li> <li>Press the following keys to program. <b>0 1 0 1 2 0 0 1</b> <small>SUB TOTAL</small> <small>CA / AMT / TEND</small></li> </ol> <p>If you want to cancel this operation, press <small>SUB TOTAL</small> instead of <small>CA / AMT / TEND</small>.</p>	<p>Setting the Australian GST</p>																

## 4. Basic Operation after Basic Programming

### Note:

Whenever an error is generated, the input figures reset to 0. All printout samples are journal images and the header (date, time and consecutive no.) are eliminated from the samples.

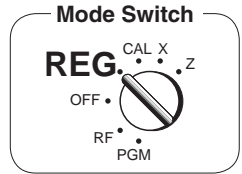

Part-1

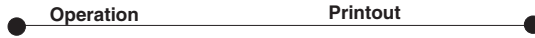

### 4-1 Open the drawer without a sale

CHK  
/NS

..... NS No Sale Symbol

### 4-2 Basic operation

Example

Unit Price	\$1.00	\$2.00	\$0.30
Quantity	1	1	1
Dept.	1	10	15
Cash Amount tendered	\$5.00		

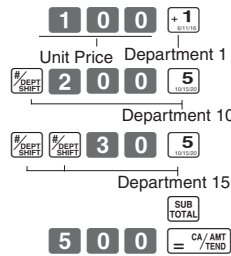

01.....1.00 — Department No./Unit Price  
10.....2.00  
15.....0.30  
•3.30 ST — Subtotal  
•5.00 CA — Cash Amount Tendered  
•1.70 CG — Change Amount Due

Cash amount tendered

Departments 6 through 10, 11 through 15, 16 through 20 can also be registered in combination with the  $\frac{1}{\text{DEPT SHFT}}$  and  $+1$ ,  $-2$ ,  $-3$ ,  $+4$  or  $5$  keys, respectively. The  $\frac{1}{\text{DEPT SHFT}}$  key should be entered just before entering unit price manually.

### 4-3 Multiple registration of the same items

Example

Unit Price	\$1.00	\$1.35
Quantity	2	3
Dept.	1	2

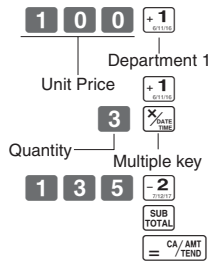

01.....1.00  
01.....1.00 — Repeat  
3 X — Sales Quantity  
•1.35 @ — Unit Price  
02.....4.05  
•6.05 CA

Note that repeat registration can be used with unit prices up to 6 digits long.

### 4-4 Charge sales

Example

Unit Price	\$1.00	\$2.00	\$3.00
Quantity	1	1	1
Dept.	1	2	1

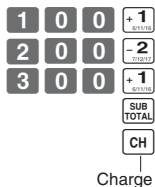

01.....1.00  
02.....2.00  
01.....3.00  
•6.00 CH — Charge Sales

Charge key

You cannot perform the amount tendered operation using the  $\text{CH}$  key.

## 4-5 Split cash/ charge sales

Example

Unit Price	\$2.00	\$3.00	\$4.00
Quantity	1	1	1
Dept.	1	2	1
Cash Amount tendered	\$5.00		

<b>Operation</b>	<b>Printout</b>
<p>2 0 0 [+ 1] <small>ST</small></p> <p>3 0 0 [+ 2] <small>ST</small></p> <p>4 0 0 [+ 1] <small>ST</small></p> <p>SUB TOTAL</p> <p>5 0 0 [CA/AMT / TEND]</p> <p>CH</p>	<p>01.....2.00</p> <p>02.....3.00</p> <p>01.....4.00</p> <p>•9.00 ST</p> <p>•5.00 CA ← Cash Amount Tendered</p> <p>•4.00 CH ← Charge Sales</p>

## 4-6 Corrections

### 4-6-1 Before you press a department key

Corrections can be made while you are registering the item (before you press a department key), or after it has already been registered into the memory (by pressing a department key).

**[AC C]** key clears the last item entered.

Example

- Entered 400 for unit price by mistake instead of 100.

<b>Operation</b>	<b>Printout</b>
<p>4 0 0 [AC C]</p> <p>Wrong entry Clears the last item entered.</p> <p>1 0 0 [+ 1] <small>ST</small></p> <p>Correct entry Registered Department 1</p>	<p>01.....1.00</p>

- Entered unit price first instead of quantity and then pressed **[X<sub>DATA</sub>]**.

<p>2 0 0 [X<sub>DATA</sub>]</p> <p>Unit price Multiplication</p> <p>[AC C]</p> <p>Clears the last item entered.</p> <p>5 [X<sub>DATA</sub>]</p> <p>Quantity Multiplication</p>	<p>5 X</p> <p>•2.00 @</p> <p>02.....10.00</p>
--	---

- Entered 150 for unit price by mistake instead of 105.

<p>1 0 [X<sub>DATA</sub>]</p> <p>Quantity Multiplication</p> <p>1 5 0 [AC C]</p> <p>Wrong entry Clears the last item entered.</p> <p>1 0 [X<sub>DATA</sub>]</p> <p>Quantity</p> <p>1 0 5 [x 3] <small>ST</small></p> <p>Correct entry Registered Department 3</p>	<p>10 X</p> <p>•1.05 @</p> <p>03.....10.50</p>
---	--

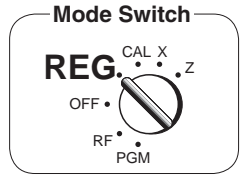

### 4-6-2 After you pressed a department key



#### Example

- Entered unit price 550 by mistake instead of 505 and pressed a department key.

key cancels the last registered item.

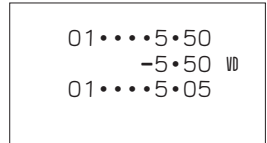
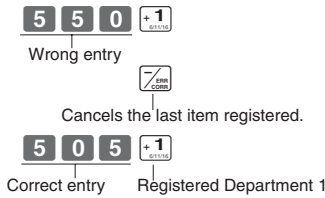

- Entered unit price 220 by mistake instead of 230 and pressed a department key.

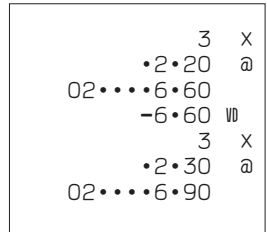
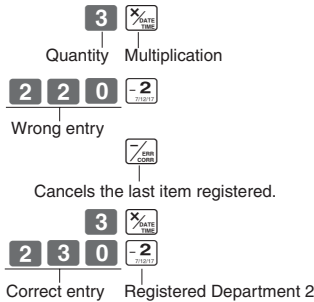

### 4-7-1 Registering with currency exchange

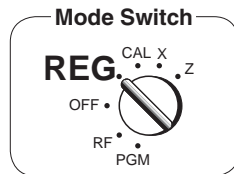

#### Example

Unit Price	£2.00
Quantity	3
Dept. 1	1
Cash Amount tendered	10.00 Euro
Rate	1Euro = £ 0.8
Main currency	Local (£)
Printout of ST	Both currencies

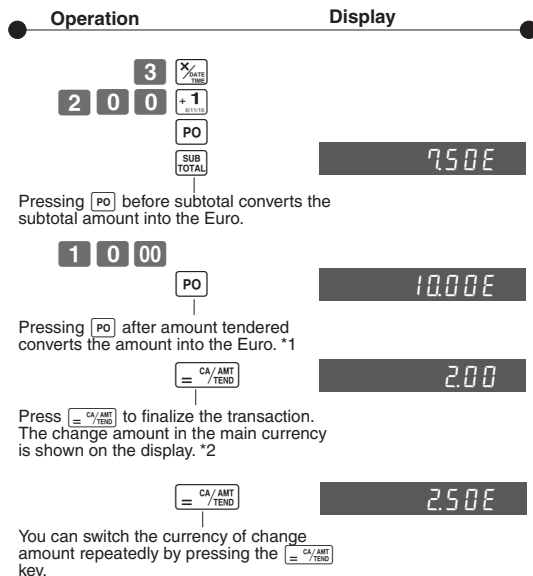

- \*1 If the payment is the same as the subtotal amount, you can omit this operation. Press directly after the subtotal.
- \*2 If the payment is less than the subtotal amount, the cash register specifies it as a partial payment and shows the balance in the main currency on the display.

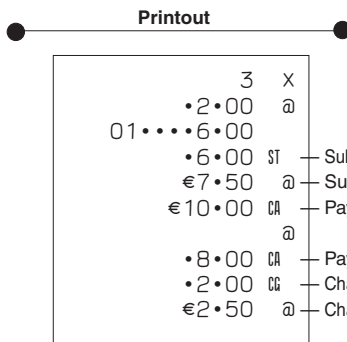



## 5. Daily Management Report

This section tells you the procedures to use to produce reports of the transaction data stored in the cash register's memory.

### Important

Remember that when you issue a reset (Z) report, the data that is reported is cleared from the applicable totalizers. To view data without clearing totalizers, issue a read (X) report.

Part-1

### 5-1 Financial Report

Operation Printout

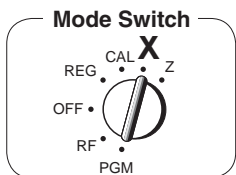

08-01-10	—	Date
12-35#0085	—	Time/Consecutive No.
	X	Read Symbol
158 *	—	Gross Sales No. of items
• 16676 • 48 *	—	Gross Sales Amount
46 NT	—	Net Sales No. of Customers
• 16675 • 99	—	Net Sales Amount
• 16518 • 99 CA #	—	Cash Total in Drawer
• 92 • 00 CH #	—	Charge Total in Drawer
• 70 • 00 *CK	—	Check Total in Drawer

### 5-2 General Control Read/Reset Report

Operation Printout

#### 5-2-1 Daily Read/Reset Report

Mode Switch to **(X)** (Read)

Mode Switch to **(Z)** (Reset)

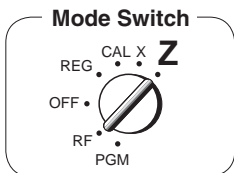

Z (Reset) report

1#08-01-10	—	Clerk No./Date
19-35#0086	—	Time/Consecutive No.
0001 Z	—	Non-resettable No. of Resets <sup>1</sup> /RESET Symbol <sup>1</sup>
01 ••••• 48	—	Dept. No./ No. of Items
• 166 • 94	—	Amount
02 ••••• 61		
• 1259 • 15		
03 ••••• 44		
• 15175 • 39		
20 ••••• 75		
• 75 • 00		
158 *	—	Gross Sales No. of Items
• 16676 • 48 *	—	Gross Sales Amount

**Part-1 QUICK START OPERATION**

• 1•40	-	Reduction Amount	
• 0•91	%-	Premium/Discount Amount	
• 1182•64	TA	Taxable Amount for Tax Rate 1	
• 62•07	TX 1	Tax Amount for Tax Rate 1	
• 167•45	*TA	Taxable Amount for Tax Rate 2	
• 16•75	TX2	Tax Amount for Tax Rate 2	
	46	NT	Net Sales No. of Customers
• 16675•99	NT	Net Sales Amount	
1• 16675•99		Clerk 1 Sales Amount (Refer to 2-8 Cashier Assignment)	
	47	CA	Cash Sales Count
• 16513•99	CA	Cash Sales Amount	
	4	CH	Charge Sales Count
• 92•00	CH	Charge Sales Amount	
	1	CK	Check Sales Count
• 70•00	CK	Check Sales Amount	
• 15•00	RA	Received On Account Amount	
• 10•00	PO	Paid Out Amount	
	4	VD	Error Correction Count
	1	RF	Refnd Mode Count
• 3•00	RF	Refund Mode Amount	
	16	CA X	No. of $\left[ \begin{smallmatrix} CA/AMT \\ = \\ /TEND \end{smallmatrix} \right]$ key operation in CAL mode
	1	NS	No sale Count
• 16518•99	CA#	Cash in Drawer	
• 92•00	CH#	Charge in Drawer	
• 70•00	*CK	Check in Drawer	
000001		Non-resettable Grand Sales total	
6675•99		(Printed only on RESET report) <sup>2</sup>	

X (Read) report is the same except <sup>1</sup> and <sup>2</sup>.

**5-2-2 Periodic Read/  
Reset Report**

● Operation

Printout ●

Mode Switch to **Z** or **X**

**1 0**  $\left[ \begin{smallmatrix} CA/AMT \\ = \\ /TEND \end{smallmatrix} \right]$

08-01-10		Date	
19-50#0087		Time/Consecutive No.	
#10#••••	X	} Periodic Read Symbol	
	X		
	77 *	Gross Sales No. of Items	
• 1116•90	*	Gross Sales Amount	
	11	NT	Net Sales No. of Customers
• 1116•90	NT	Net Sales Amount	

# Part 2

## CONVENIENT OPERATION

### 1. Various Programming

#### 1-1 Unit price for Departments

Example

Unit Price	\$1.00	\$2.20	\$11.00
Dept.	1	2	3

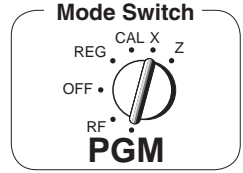
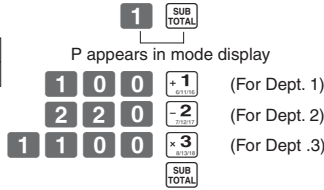

•Unit prices within the range of 0.01~9999.99.

#### 1-2 Rate for percent key

Example

Discount Rate	2.5%
---------------	------

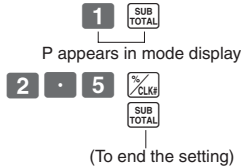

•The rate within the range of 00.01 to 99.99%.

#### 1-3 To change tax status for Departments

Tax status for the Departments 1 ~ 20 are initialized as Non-Taxable.

Example

Status	Taxable 1	Taxable 2
Depts.	1	7

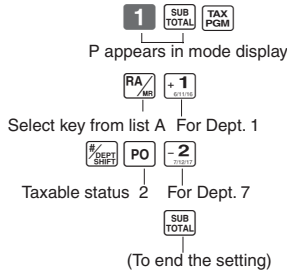

Selections	
Taxable status 1	RA/MS
Taxable status 2	PO
Taxable status 3	CH
Taxable status 4	X/MS
Non-taxable status	CHK/MS

A

## 1-4 Status for Department

Example

Depts.	Selections		
	A	B	C
1	0	4	1
2	0	5	1

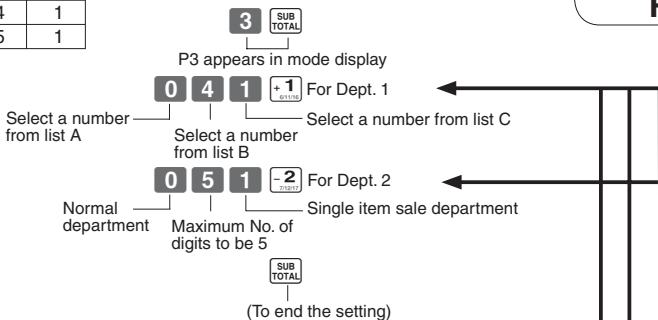
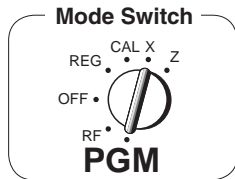

Selections		
Normal department	<input type="button" value="0"/>	A
Minus department	<input type="button" value="1"/>	
No limitation for manually entered price.	<input type="button" value="0"/>	B
Maximum number of digits for manually entered price. (1 ~ 7 digits)	<input type="button" value="1"/> ~ <input type="button" value="7"/>	
To prohibit manual price entries.	<input type="button" value="8"/> or <input type="button" value="9"/>	
Normal sales (not a single-item sale) department	<input type="button" value="0"/>	C
Set as a single-item sale department	<input type="button" value="1"/>	

## 1-5 Status for percent key

**1-5-1 To change taxable status** The percent key is initialized as Non-taxable. for the percent key

Example

Change Percent key registration as a Taxable status 1.

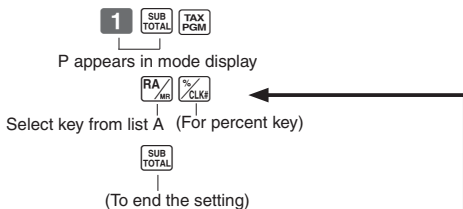

Selections		
Taxable status 1	<input type="button" value="RA/mb"/>	A
Taxable status 2	<input type="button" value="PO"/>	
Taxable status 3	<input type="button" value="CH"/>	
Taxable status 4	<input type="button" value="X/mb"/>	
All taxable status (1, 2, 3 and 4)	<input type="button" value="RA/mb"/> <input type="button" value="PO"/>	
Non-taxable status	<input type="button" value="CHK/mb"/>	

### 1-5-2 Status for percent key

Example

Round	Up
Percent	%+

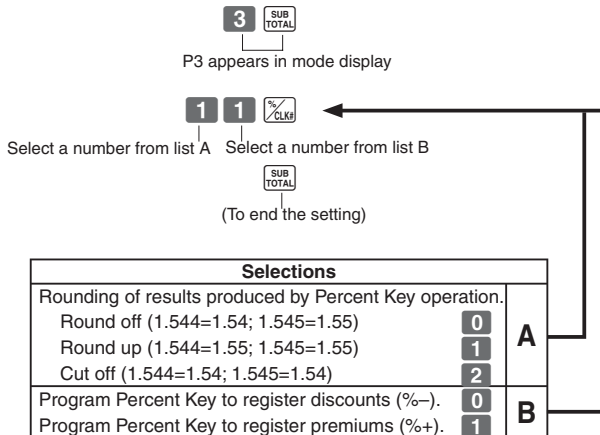

### 1-6 Taxable Status for minus key

The minus key is initialized as Non-taxable.

Example :  
Change minus key registrations  
Taxable status 1.

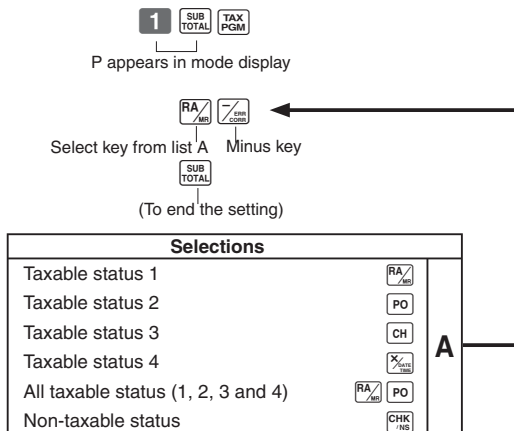

## 1-7 General features

### 1-7-1 To set general controls

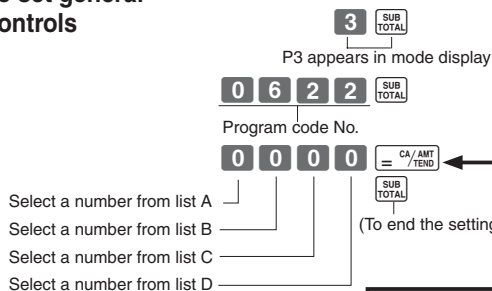
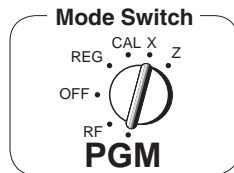

Selections			
Limit the last 1 digit of total amount to 0 and 5 when Malaysian rounding is specified for subtotal and total amount.			
Time display format:			
HH-MM	No		0
	Yes		1
HH-MM SS	No		4
	Yes		5

**A**

Selections			
Maintain key buffer during receipt issue in REG mode.			
Reset the transaction number to zero whenever a General Control Reset Report is issued.			
Allow credit balance registration.			
No	Yes	Yes	0
		No	1
	No	Yes	2
		No	3
Yes	Yes	Yes	4
		No	5
	No	Yes	6
		No	7

**B**

Selections			
Limit the last 2 digits of cash amount tendered to 00 and 50 when Denmark rounding is specified for subtotal and total amount.			
Allow partial cash amount tendered.			
Allow partial check amount tendered.			
Yes	Yes	No	0
		Yes	1
	No	No	2
		Yes	3
No	Yes	No	4
		Yes	5
	No	No	6
		Yes	7

**C**

Selections			
Use the 00 key as a 000 key.			
Cashier assignment systems (sign on) is used.			
No	No		0
	Yes		1
Yes	No		2
	Yes		3

**D**

**1-7-2 To set printing controls**

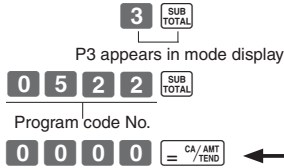

- Select a number from list A
- Select a number from list B
- Select a number from list C
- Select a number from list D

Selections	
Use the printer to print a journal.	0
Use the printer to print receipts.	1

Selections	
Print zero-total line on the General Control Read/Reset Reports	
Print Total line at finalization (only for Australia).	
No	Yes 0 No 1
Yes	Yes 4 No 5

Selections	
Print RF switch mode refund count/ amount on the General Control Read/Reset Reports.	
Print the grand sales total on the General Control Reset Reports.	
Print the time on the receipt and journal.	
Yes	No Yes 0 No 1 Yes Yes 2 No 3
No	No Yes 4 No 5 Yes Yes 6 No 7

Selections	
Print the consecutive number on the receipt/journal.	
Print the subtotal on the receipt/ journal when the Subtotal Key is pressed.	
Skip item print on journal.	
No	No Yes 0 No 1 Yes Yes 2 No 3
Yes	No Yes 4 No 5 Yes Yes 6 No 7

Part-2

**Part-2 CONVENIENT OPERATION**

**1-7-3 Printer switch for Receipt or Journal**

The printer is initialized as journal.

Example

To print a receipt

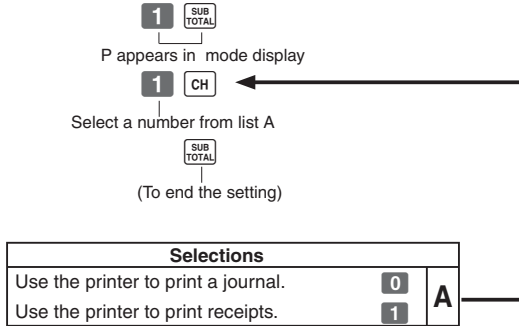
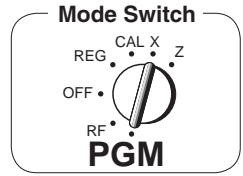

- Printer selection to print a journal or receipts can also be set on procedures 1-7-2 "To set printing controls".



## 1-8 PLU setting

### 1-8-1 Linkage with Departments

Example

PLU No.	1	100
Link dept. No.	4	4

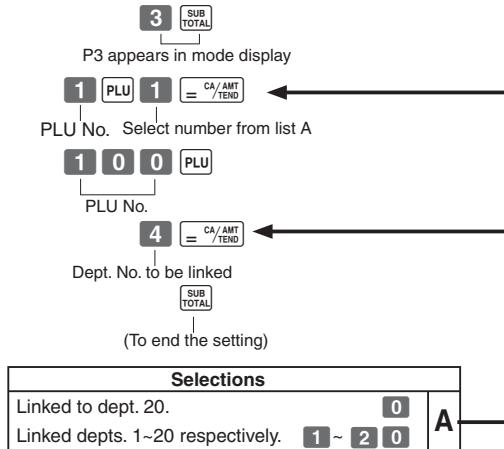

- 120 PLUs can be set.
- When the linked department is not specified, the PLU is linked to department 20.
- Status for a single-item sale and tax status are followed the specified linked department.

### 1-8-2 Unit Prices for PLUs

Example

PLU No.	1	2
Unit Price	\$1.00	\$3.00

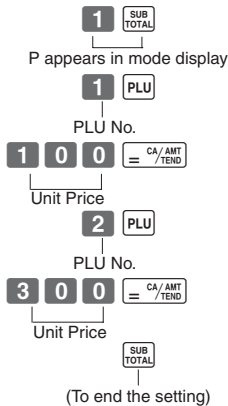

- Unit prices within the range of \$0.01~999.99.

## 1-9 Setting the Tax Rate and rounding

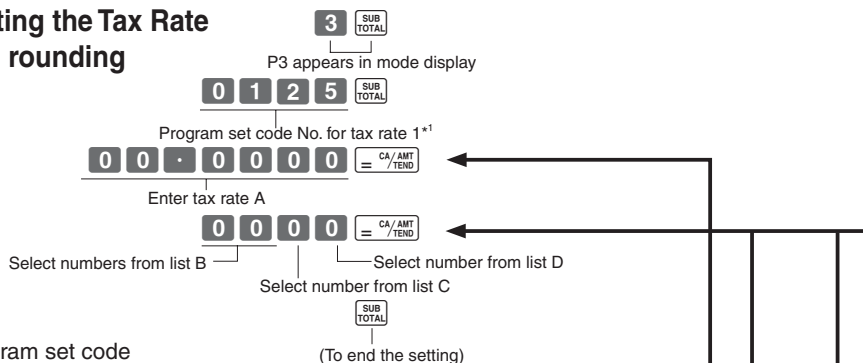

\*1 Program set code No. for Tax rate 2 is

0 2 2 5

Tax rate 3 is

0 3 2 5

Tax rate 4 is

0 4 2 5

• You can use either an add-on rate tax or an add-in rate tax (VAT), depending on the requirements in your area. You can specify only one tax rate.

• The normal rounding specification tells the cash register how to round tax amounts to the proper number of decimal places.

• The special rounding specification and Danish rounding tell the cash register how to round off subtotals and totals so that their rightmost 2 digits are 00 and 50.

• Note that the rounding specification you program for your cash register depends on the tax laws of your country.

Tax rate specifications	
The tax rate within the range of 0.0001 ~ 99.9999%. Use <b>.</b> key for decimal point.	<b>A</b>

Normal rounding specifications	
Cut off to 2 decimal places. (1.544=1.54; 1.545=1.54)	<b>0 0</b>
Round off to 2 decimal places. (1.544=1.54; 1.545=1.55)	<b>5 0</b>
Round up to 2 decimal places. (1.544=1.55; 1.545=1.55)	<b>9 0</b>

Special rounding specifications for subtotal and total amounts	
No specifications	<b>0</b>
Special rounding 1: 0 ~ 2 → 0; 3 ~ 7 → 5; 8 ~ 9 → 10 Examples: 1.21=1.20; 1.26=1.25; 1.28=1.30	<b>1</b>
Special rounding 2: 0 ~ 4 → 0; 5 ~ 9 → 10 Examples: 1.123=1.120; 1.525=1.530	<b>2</b>
Danish rounding <sup>*1</sup> : 0 ~ 24 → 0; 25 ~ 74 → 50; 75 ~ 100 → 100 (set the amount tender restriction on page 22 also)	<b>3</b>
Malaysian rounding: 0 ~ 2 → 0; 3 ~ 7 → 5; 8 ~ 9 → 10 (set the amount tender restriction on page 22 also)	<b>5</b>
Scandinavian rounding: 0 ~ 24 → 0; 25 ~ 74 → 50; 75 ~ 99 → 100 Examples: 1.21=1.0; 1.30=1.50; 1.87=2.00	<b>6</b>
Australian rounding (only for tax rate 1) 0 ~ 2 → 0; 3 ~ 7 → 5; 8 ~ 9 → 10 Examples: 1.21=1.20; 1.26=1.25; 1.28=1.30	<b>7</b>
Czech rounding: 0 ~ 49 → 00; 50 ~ 99 → 100 Examples: 1.23=1.00; 1.52=2.00	<b>8</b>

Normal rounding specifications	
No specifications.	<b>0</b>
Specifies add-on rate tax.	<b>2</b>
Specifies add-in rate tax (VAT).	<b>3</b>

See page 19 (department key), 20 (percent key), 21 (minus key) to change the fixed tax status.

\*1: In case of defining Danish rounding, the Euro should be set to the sub currency and the local to the main currency.

# 1-10 To control Tax Status printing

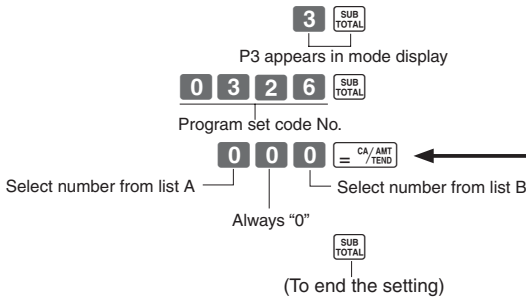
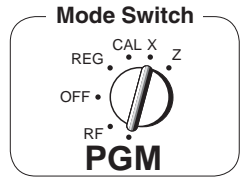

Selections		
Print tax total line (only for Australia).		
Print tax symbol.		
Yes	No	0
	Yes	1
No	No	2
	Yes	3
		<b>A</b>

Selections		
Print taxable amount.		
Print taxable amount and tax amount for Add-in.		
Yes	Yes	0
	No	1
No	Yes	2
	No	3
		<b>B</b>

Part-2

## 1-11 Printing to read All Preset Data

- Printing preset data.

### 1-11-1 Printing preset data except PLU settings



$\frac{CA/AMT}{TEND}$

08-01-10	—	Date
08-06#0038	—	Time/Consecutive No.
01.....1.00	X	Read Symbol
01-041	—	Dept No./Unit Price
02.....2.20	—	Tax Status/Normal Dept/ Digit Limit/Single Item
02-051	—	
20.....	—	
04-000	—	
-.....01	—	Minus/Tax Status
2.5 %	—	Percent Rate/%+ or %-
15-11	—	Tax Status/Percent Key Control
€1•23242	#	Euro Exchange Rate
0122...#22	—	Date/Monetary Mode Control
0222•#0000	—	
0522•#0062	—	Print Control
0622•#0000	—	General Control
1022...#3	—	Calculation Control
0326...#002	—	Tax Control
2422...#0	—	Euro Status
0125.....	—	
5•2500 %	—	Tax Rate1
5003	—	Rounding specification/ Tax System specification
0000	—	
0225.....	—	
10•0000 %	—	Tax Rate 2
5003	—	
0000	—	
0425.....	—	
25•0000 %	—	Tax Rate 4
5003	—	
0000	—	
08-01-10	—	

#### Tax Status

Printout	Meaning
00	Non taxable
01	Taxable 1
02	Taxable 2
03	Taxable 3
04	Taxable 4
15	All taxable

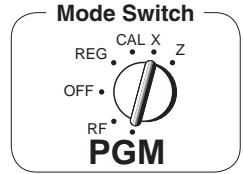

**1-11-2 Printing preset PLU settings**



**1**  CA/AMT  
 /TEND

```

08-01-10
08-10#0039
X
001•••1•00
    01
002•••2•20
    02
003•••3•00
    03
004•••4•00
    04
100••10•00
    20
08-01-10
    
```

- Date
- Time/Consecutive No.
- Read symbol
- PLU No./Unit Price
- Linked department

Part-2

## 2. Various Operations

### 2-1 Registration using preset price for Departments.

(Programming: See page 19)

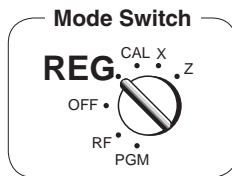

Operation	Printout																
<p>Example</p> <table border="1"> <tr> <td>Unit Price</td> <td>\$1.00</td> <td>\$2.20</td> <td>\$11.00</td> </tr> <tr> <td>Quantity</td> <td>1</td> <td>2</td> <td>4</td> </tr> <tr> <td>Depts.</td> <td>1</td> <td>2</td> <td>3</td> </tr> <tr> <td>Amount tendered</td> <td colspan="3">\$50.00</td> </tr> </table>	Unit Price	\$1.00	\$2.20	\$11.00	Quantity	1	2	4	Depts.	1	2	3	Amount tendered	\$50.00			<div style="display: flex; align-items: center; gap: 10px;"> <div style="text-align: center;"> <p>4</p> <p><b>5 0 0 0</b></p> </div> <div style="border: 1px solid black; padding: 5px;"> <p><b>+ 1</b> (0110)</p> <p><b>- 2</b> (0107)</p> <p><b>- 2</b> (0107)</p> <p><b>4</b> <b>X</b> (0107) <b>X 3</b> (0107)</p> <p><b>SUB TOTAL</b></p> <p><b>=</b> <b>CA/AMT /TEND</b></p> </div> </div> <div style="border: 1px solid black; padding: 10px; margin-top: 10px;"> <p>01.....1.00 — Dept.1 Unit Price</p> <p>02.....2.20 — Dept.2 Unit Price</p> <p>02.....2.20 — Repeat</p> <p style="padding-left: 40px;">4 X — Multiplication Symbol</p> <p style="padding-left: 40px;">• 11.00 @ — Dept.3 Unit Price</p> <p>03.....44.00</p> <p style="padding-left: 40px;">• 49.40 ST — Cash Amount Tendered</p> <p style="padding-left: 40px;">• 50.00 CA — Change</p> <p style="padding-left: 40px;">• 0.60 CC</p> </div>
Unit Price	\$1.00	\$2.20	\$11.00														
Quantity	1	2	4														
Depts.	1	2	3														
Amount tendered	\$50.00																

### 2-2 Single-Item Sales

(Programming: See page 20)

Example 1:

Status	Single item sale
Unit Price	\$0.50
Quantity	1
Dept.	1

**5 0 + 1** (0110)

01.....0.50

• 0.50 CA — Cash Sales

For this example, Dept. 1 is programmed for a single-item-sale.

Example 2:

Status	Normal	Single item sale
Unit Price	\$1.00	\$0.50
Quantity	1	1
Dept.	2	1

**1 0 0 - 2** (0107)

**5 0 + 1** (0110)

**SUB TOTAL**

**=** **CA/AMT /TEND**

02.....1.00

01.....0.50

• 1.50 CA — Cash Sales

Single-item sale cannot be finalized if an item is registered previously.

## 2-3 Check sales

Example

Unit Price	\$35.00
Quantity	2
Depts.	4

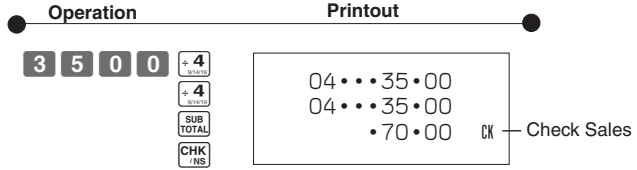

## 2-4 Split cash/ check sales

Example

Unit Price	\$30.00	\$25.00
Quantity	1	1
Depts.	2	3
Cash amount tendered	\$20.00	
Check	\$35.00	

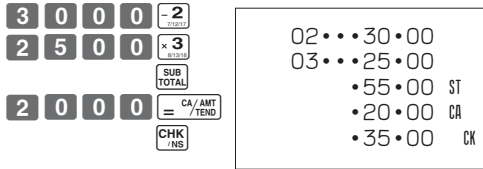

### Mode Switch

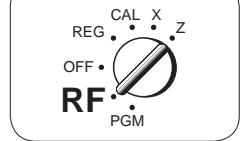

## 2-5 Refund

Example

Unit Price	\$1.00	\$2.00
Quantity	1	1
Depts.	2	3

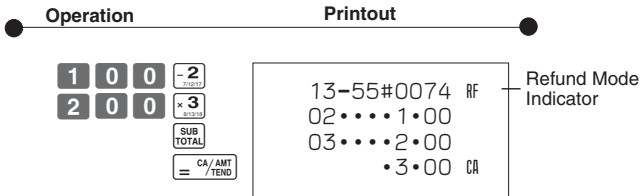

After you finish RF mode operation, be sure to return the Mode Switch to the REG (register) setting.

## 2-6 PLU operation

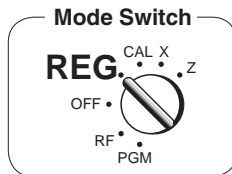

### 2-6-1 PLU registration

(Programming: See page 25)

Example

PLU No.	1	2
Unit Price	\$1.00	\$2.00
Quantity	2	4
Depts.	1	1
Cash amount tendered	\$10.00	

Operation



Printout

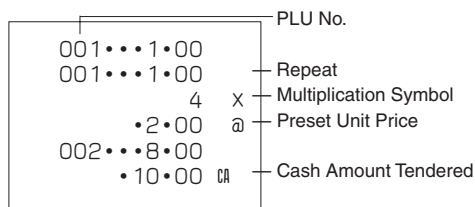

### 2-6-2 PLU Single-Item Sale

(Programming: See page 25)

Example

PLU No.	1
Status	Single item sale
Unit Price	\$1.00
Quantity	1

Operation



Printout

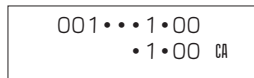

- For this example, linked department 1 is programmed for a single-item-sale.
- Single-item sale cannot be finalized if an item is registered previously.

### 2-6-3 PLU report

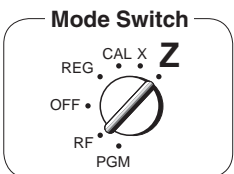
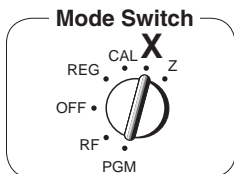

Operation



Printout

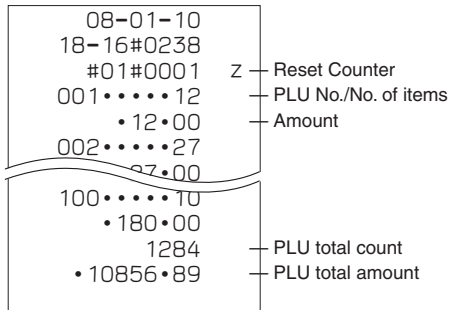



## 2-7 Other registrations

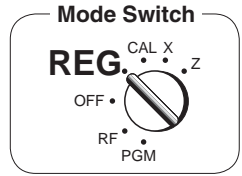

### 2-7-1 Reading the Time and Date

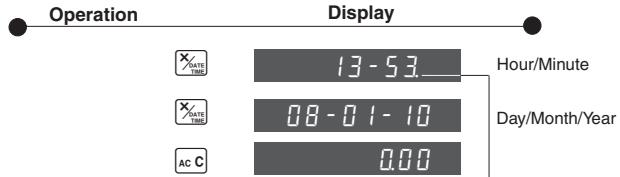

• Flashes per second

- If you have changed the date order (refer to page 9), enter date of that order.

Part-2

### Adjusting the Time

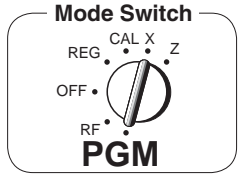

- Turn the Mode Switch to PGM.

#### Example

Current time = 13:58

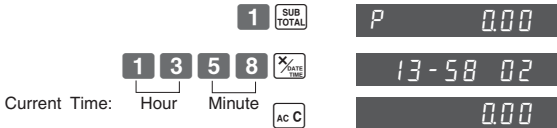

- Enter current time in 24 hour system.

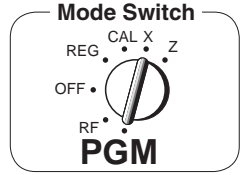

### Adjusting the Date



- Turn the Mode Switch to PGM.

#### Example

Current date = 8, January 2010

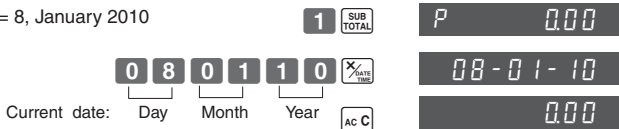

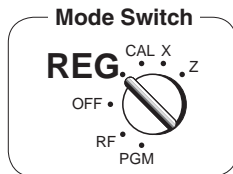

- Enter current date in 6 digits.
- Enter the last 2 digits for year set. (2010 → 10)

## Part-2 CONVENIENT OPERATION





### 2-7-2 Paid out from cash in drawer

● Operation	Printout	●
12345678  Enter reference No. 1 0 0 0 	# 12345678 08-01-10 13-57#0060 • 10.00 PO	Reference Number   Paid Out Amount

### 2-7-3 Cash received on account





● Operation	Printout	●
6 0 0 	• 6.00 RA	Received On Account Amount

### 2-7-4 Registering identification numbers

● Operation	Printout	●
A reference number or ID number of up to 8 digits can be registered prior to any transaction.		
1 2 3 4 5 6 7 8  5 0  = 	# 12345678 08-01-10 13-59#0062 01.....0.50 • 0.50 CA	Reference Number or ID No.

### 2-7-5 Reduction on subtotal

Example:  
Amount due reduced by \$0.50.

● Operation	Printout	●
1 0 0  2 0 0  SUB TOTAL 5 0  = 	01.....1.00 04.....2.00 -0.50 • 2.50 CA	

### 2-7-6 Premium/Discount

•2.5% premium/discount (programmed to [%] key) applied to first item.

- 7% premium/discount applied to transaction total.
- For programming the [%] key as percent minus or percent plus, see page 21.
- For programming percent rate, see page 20.

	Operation		Printout	
			<div style="border: 1px solid black; padding: 5px; width: 45%;"> <p style="text-align: center; margin: 0;">Premium</p> <p>01.....1.00</p> <p style="padding-left: 100px;">2.5 % *1</p> <p style="padding-left: 100px;">0.03 *2</p> <p>02.....2.00</p> <p>01.....3.00</p> <p style="padding-left: 100px;">6.03 ST *3</p> <p style="padding-left: 100px;">7 % *4</p> <p style="padding-left: 100px;">0.42 *5</p> <p style="padding-left: 100px;">6.45 CA</p> </div> <div style="border: 1px solid black; padding: 5px; width: 45%;"> <p style="text-align: center; margin: 0;">Discount</p> <p>01.....1.00</p> <p style="padding-left: 100px;">2.5 % *1</p> <p style="padding-left: 100px;">-0.03 *2</p> <p>02.....2.00</p> <p>01.....3.00</p> <p style="padding-left: 100px;">5.97 ST *3</p> <p style="padding-left: 100px;">7 % *4</p> <p style="padding-left: 100px;">-0.42 *5</p> <p style="padding-left: 100px;">5.55 CA</p> </div>	
<div style="display: flex; flex-direction: column; gap: 5px;"> <div style="display: flex; align-items: center;"> <div style="border: 1px solid black; padding: 2px 5px; margin-right: 5px;">1</div> <div style="border: 1px solid black; padding: 2px 5px; margin-right: 5px;">0</div> <div style="border: 1px solid black; padding: 2px 5px; margin-right: 5px;">0</div> <div style="border: 1px solid black; padding: 2px 5px; margin-right: 5px;">+1</div> <div style="font-size: 8px;">% / CLK</div> </div> <div style="display: flex; align-items: center;"> <div style="border: 1px solid black; padding: 2px 5px; margin-right: 5px;">2</div> <div style="border: 1px solid black; padding: 2px 5px; margin-right: 5px;">0</div> <div style="border: 1px solid black; padding: 2px 5px; margin-right: 5px;">0</div> <div style="border: 1px solid black; padding: 2px 5px; margin-right: 5px;">-2</div> <div style="font-size: 8px;">% / CLK</div> </div> <div style="display: flex; align-items: center;"> <div style="border: 1px solid black; padding: 2px 5px; margin-right: 5px;">3</div> <div style="border: 1px solid black; padding: 2px 5px; margin-right: 5px;">0</div> <div style="border: 1px solid black; padding: 2px 5px; margin-right: 5px;">0</div> <div style="border: 1px solid black; padding: 2px 5px; margin-right: 5px;">+1</div> <div style="font-size: 8px;">% / CLK</div> </div> <div style="display: flex; align-items: center;"> <div style="border: 1px solid black; padding: 2px 5px; margin-right: 5px;">7</div> <div style="border: 1px solid black; padding: 2px 5px; margin-right: 5px;">%</div> <div style="border: 1px solid black; padding: 2px 5px; margin-right: 5px;">%</div> <div style="font-size: 8px;">% / CLK</div> </div> <div style="display: flex; align-items: center;"> <div style="border: 1px solid black; padding: 2px 5px; margin-right: 5px;">=</div> <div style="font-size: 8px;">CA / AMT / TEND</div> </div> </div>			<p>*1 Premium/Discount Rate</p> <p>*2 Premium/Discount Amount</p> <p>*3 Subtotal</p> <p>*4 Premium/Discount Rate</p> <p>*5 Premium/Discount Amount</p>	

### 2-8 Cashier Assignment

(Programming: See page 22)

**Mode Switch**  
**In any mode**  
**REG, RF, CAL,**  
**X or Z,**  
**except PGM**

Cashier assignment system is used to control each cashier (or clerk) sales total. When you select this function on page 22, you can get 8 cashiers (or clerk) sales data. Cashier assignment must be performed prior to starting registration or any other operation, except Program mode.

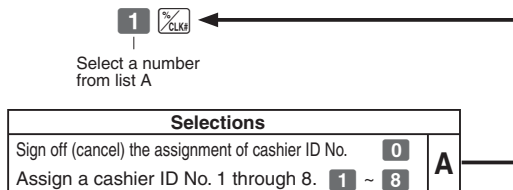

- Currently assigned cashier (or clerk) ID number is printed on the receipt or journal for each transaction.
- The assigned clerk memory number is automatically signed off when the mode key is set to OFF position.
- The assigned cashier (or clerk) sales totals with ID number are printed on the receipt or journal when you perform daily X/Z sales report.

Part-2

# Part 3

## CALCULATOR FUNCTION

### 1. Calculator Mode

While registering at REG mode, you can switch to CAL mode and then return to REG mode to resume the registration.

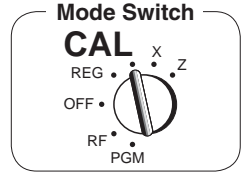
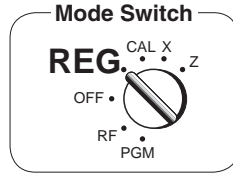

### 1-1 Calculation examples

Operation	Display
	[ ] 0
AC c 5 + 1 1 AC c (Miss operation) (Cancels item entered.)	
5 + 1 3 - 2 2 = CA/AMT/TEND	6
2 3 - 2 5 6 x 3 7 8 = CA/AMT/TEND	-2574
4 x 3 3 - 2 6 ÷ 4 3 · 5 + 1 8 = CA/AMT/TEND	97142857
1 5 0 0 x 3 1 2 %/CLK	180

### 1-2 Memory recall

Recalls the current amount onto the display.  
 – during registration: current subtotal  
 – registration has been completed: the last amount

Operation	Display
1 0 00 + 1 2 0 00 - 2	
RA/MR ÷ 4 3 = CA/AMT/TEND	10
Memory recall	

#### On REG mode

#### On CAL mode

Example:

Divide the current subtotal \$30.00 at REG mode by 3 (to divide the bill between 3 people).

Recalls the current result by pressing  $\frac{CA}{AMT}/TEND$  key at CAL mode on the display.

#### On REG mode

Example:

Recall the current result at CAL mode during registration, and register the cash amount due for each person.

Operation	Printout
RA/MR = CA/AMT/TEND RA/MR = CA/AMT/TEND RA/MR = CA/AMT/TEND	
Memory recall	
	01...10.00 02...20.00 •30.00 ST •10.00 CA •10.00 CA •10.00 CA •0.00 CG

### 1-3 Setting for calculator operation

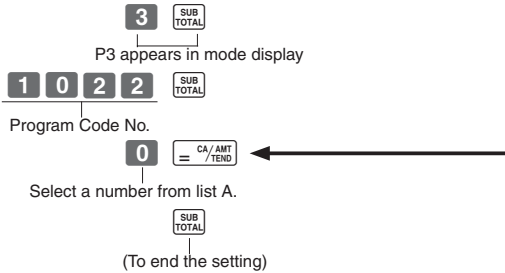
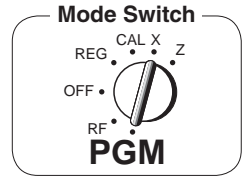

Selections			
Open drawer whenever <small>CA / AMT / TEND</small> is pressed.*	No	No	<b>0</b>
Open drawer whenever <small>CHK / NS</small> is pressed.*	Yes	Yes	<b>1</b>
Print No. of Equal key operations on General Control X and Z reports.	No	No	<b>2</b>
	Yes	Yes	<b>3</b>
Yes	No	No	<b>4</b>
	Yes	Yes	<b>5</b>
	No	No	<b>6</b>
	Yes	Yes	<b>7</b>
No	No	No	<b>4</b>
	Yes	Yes	<b>5</b>
	No	No	<b>6</b>
	Yes	Yes	<b>7</b>

**A**

\*Drawer does not open during registration procedures even if you press CA / AMT / TEND or CHK / NS by turning the mode switch to CAL position.



# USEFUL INFORMATION

## 1. Troubleshooting

	Symptom/Problem	Most common causes	Solutions
1	E01 appears on the display.	Changing modes without completing transaction.	Return mode switch to where it stops buzzing and press $\left[ \frac{CA/AMT}{= / \text{END}} \right]$ .
2	E08 appears on the display.	Sign on operation is not performed.	Prior to starting registration of any other operation, press <b>1 ~ 8</b> and then $\left[ \frac{\%}{\text{CLK}} \right]$ .
3	E94 appears on the display.	Printer paper is jammed.	Remove jammed paper. Turn Mode switch to OFF then turn to ON, or Turn power OFF and then turn power ON.
4	No date on receipt. Paper is not advancing enough.	Printer is programmed as a journal.	Program printer to print receipts.
5	Drawer opens up after ringing up only one time.	Department is programmed as a single item dept.	Program the dept. as a normal dept.
6	Not clearing totals at end of day after taking report.	Using X mode to take out reports.	Use Z mode to take out reports.
7	Programming is lost whenever register is unplugged or there is a power outage.	Bad or no batteries.	Put in new batteries.
8	Register is inoperative. Can't get money out of drawer.	No power.	Pull lever underneath register at rear.
9	E90 appears on the display.	Totals remain in the memory.	Issue the general control reset report, periodic reset report and PLU reset report.

## 2. Specifications

### INPUT METHOD

Entry: 10-key system; Buffer memory 8 keys (2-key roll over)  
 Display (LED): Amount 8 digits (zero suppression); Department/PLU No.; No. of repeats

### PRINTER

Journal: 12 digits (Amount 10 digits, Symbol 2 digits)  
 (or receipt) Automatic paper roll winding (journal)  
 Paper roll: 58 mm × 80 mm Ø (Max.)

### CALCULATIONS

Entry 8 digits; Registration 7 digits; Total 8 digits

### CALCULATOR FUNCTION

8 digits; Arithmetic calculations; Percent calculations

### Memory protection batteries:

The effective service life of the memory protection batteries 3 (UM-3, or R6P (SUM-3) type batteries) is approximately one year from installation into the machine.

Power source/Power consumption: See the rating plate.

Operating temperature: 0°C to 40°C (32°F to 104°F)

Humidity: 10 to 90%

Dimensions/Weight: 188 mm(H) × 330 mm(W) × 360 mm(D) with S drawer  
 4 kg with S drawer  
 205 mm(H) × 410 mm(W) × 450 mm(D) with M drawer  
 8 kg with M drawer

*Specifications and design are subject to change without notice.*

### When the cash drawer does not open!

In case of power failure or the machine is in malfunction, the cash drawer does not open automatically. Even in these cases, you can open the cash drawer by pulling drawer release lever (see below).

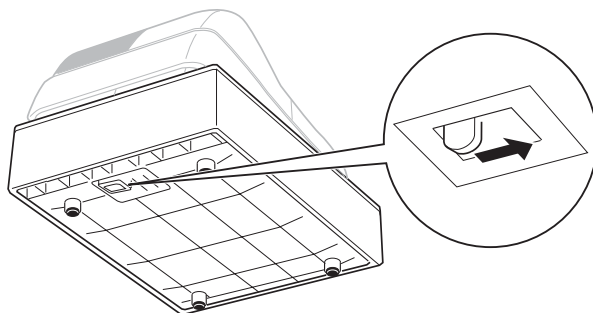

### Important!

The drawer will not open, if it is locked with a drawer lock key.

### ► To replace the ink roll

- ① Turn to the OFF mode and remove the printer cover.
- ② Lift up the tab on the ink roll marked "PULL UP".
- ③ Install a new Ink Roll and press it down firmly but gently until it snaps into place.
- ④ Replace the printer cover onto the cash register.
- ⑤ Turn to the REG mode, and press the  key to check for correct operation.

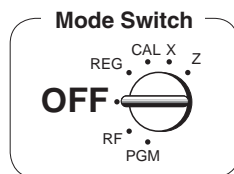

Laite on liitettävä suojamaadoituskostkettimilla vaurstettuun pistrasiaan  
Apparatet må tiloples jordet dtikkontakt  
Apparaten skall anslutas till jordat nätuttag



This mark applies in EU countries only.



Manufacturer:  
CASIO COMPUTER CO., LTD.  
6-2, Hon-machi 1-chome, Shibuya-ku Tokyo 151-8543, Japan  
Representative within the European Union:  
Casio Europe GmbH  
Casio-Platz 1, 22848 Norderstedt Germany

Please keep all information for future reference.

**CASIO®**

**CASIO COMPUTER CO., LTD.**  
6-2, Hon-machi 1-chome  
Shibuya-ku, Tokyo 151-8543, Japan

MA0812-A

140CR\*E  
Printed in Indonesia  
Printed on recycled paper.