

Series 370

Granville-Phillips Series 370 Stabil-Ion[®] Vacuum Measurement Controller



Instruction Manual

Instruction manual part number 370119

Revision 05 - November 2007

Series 370

Granville-Phillips Series 370 Stabil-Ion® Vacuum Measurement Controller

This Instruction Manual is for use with all Granville-Phillips Series 370 Vacuum Measurement Controllers. The “#” symbol represents a variable in the catalog number.

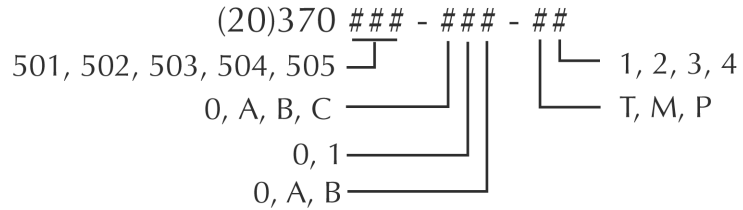

Customer Service/Support

For customer service, 24 hours per day, 7 days per week, every day of the year including holidays, toll-free within the U.S.A., phone 1-800-367-4887

For customer service within the U.S.A., 8 AM to 5 PM, weekdays excluding holidays:

- Toll-free, phone: 1-800-776-6543
- Phone: 1-303-652-4400
- FAX: 1-303-652-2844
- Email: co-csr@brooks.com
- World Wide Web: www.brooks.com

Instruction Manual

Table of Contents

Safety	v
Chapter 1 System Components	1
Chapter 2 Initial Setup Procedures	1
2.1 Control Unit Option Module Setup	1
2.1.1 Top Cover Removal	2
2.1.2 Convectron / Capacitance Manometer Pressure Units Setup	3
2.1.3 Process Control Setup	4
2.1.3.1 Ion Gauge Assignment for Process Control	5
2.1.3.2 Relay Polarity Setting	6
2.1.3.3 Process Control Tips	7
2.1.4 RS-232 Computer Interface Setup	8
2.1.4.1 Selecting the Byte Format	8
2.1.4.2 Handshaking	10
2.1.5 RS-485 Computer Interface Setup	12
2.1.5.1 RS-485 Address	12
2.1.5.2 Response Delay for the RS-485 Interface	12
2.1.5.3 Selecting the Byte Format for RS-485 Communications	13
2.1.6 IEEE 488 Computer Interface Setup	14
2.1.6.1 Selecting the Interface Bus Address	14
2.1.6.2 Talk-Only Mode	14
2.1.6.3 SRQ Mode	15
2.1.7 Replacing Control Unit Cover	15
2.2 Power Supply Setup	15
Chapter 3 Installation	1
3.1 Gauge Installation Tips	1
3.1.1 EMC Compliance	1
3.1.2 Cable Installation Statement	1
3.1.3 Environmental Conditions	2
3.2 Stabil-Ion Gauge Installation	2
3.3 Convectron Gauge Installation	3
3.3.1 Compression Mount/Quick Connect	4
3.3.2 1/8 NPT Mount	4
3.3.3 VCR [®] /VCO [®] Mount	4
3.3.4 NW16KF Flange Mount	4
3.3.5 ConFlat Flange Mount	4
3.4 Installing the Control Unit and Power Supply	5
3.4.1 Grounding the System	5
3.4.2 Installation Hardware Part Numbers	6
3.5 Connecting Analog Outputs	7
3.5.1 Stabil-Ion Gauge Analog Output Signal	7
3.5.2 Convectron Gauge Analog Output Signal	7
3.5.3 Convectron/Capacitance Manometer Analog Output Signal	8
3.6 Connecting Process Control Relays	8
3.7 Connecting Stabil-Ion Remote Control	9
3.7.1 Definition of Input States	10
3.7.2 Using the Remote Inputs	12
3.7.3 Using the Remote Outputs	13
3.8 Connecting the RS-232 Computer Interface	13
3.9 Connecting the RS-485 Computer Interface	16
3.10 Connecting the IEEE 488 Computer Interface	18
3.11 Connecting the Gauge Cables	18
3.11.1 Convectron Gauge Cable Installation	18
3.11.2 Capacitance Manometer Cable Installation	19

3.11.3	Stabil-Ion Gauge Cable Installation	19
3.12	Connecting the Power Cables	22
Chapter 4	Preparing the Stabil-Ion System for Operation	1
4.1	Preparing for Pressure Measurement with the Stabil-Ion Gauge	1
4.2	Stabil-Ion Gauge Calibration Memory	1
4.3	Memory Module Loading and Operating Parameter Setup	2
4.3.1	Overview	2
4.3.2	Loading the Stabil-Ion Memory Module	5
4.3.3	Control Menu Variables	7
4.3.3.1	Pressure Range	7
4.3.3.2	Filament Selection	8
4.3.3.3	Gauge Scale Factor	9
4.3.3.4	Selecting Gas Type for the Stabil-Ion Gauge	10
4.3.3.5	Selecting Gas Type for the Convectron Gauge	11
4.3.4	Setup Menu Variables	12
4.3.4.1	Units of Measure	12
4.3.4.2	Selecting Degas Time	12
4.3.4.3	Overpressure Threshold	13
4.3.4.4	Line Frequency	14
4.3.4.5	Pressure Display Update Speed	14
4.4	Stabil-Ion Gauge Turn On	15
4.4.1	Alternate ON/OFF Gauge Control	15
4.5	Degassing the Stabil-Ion Gauge	15
4.5.1	Pressure Indication During Degas	17
4.5.2	Degas Power Limiter	17
4.5.3	Gauge Bakeout	17
4.6	Stabil-Ion Gauge Analog Output Signal	17
4.7	Preparing for Convectron Gauge Operation	18
4.7.1	Understanding Convectron Gauge Pressure Measurement in Gases other than Nitrogen (or Air)	19
4.7.2	Examples	20
4.8	Ionization Gauge Auto Turn On/Off	28
4.8.1	To Set the On/Off Pressure for IG1/IG2	28
4.8.2	Convectron Gauge Auto Turn On/OFF for the Convectron/Capacitance Manometer Option	29
4.9	Adjustment of Convectron Gauge Zero and Atmospheric Pressure Indications	29
4.10	Convectron Gauge Analog Output Signal	30
4.11	Preparing for Capacitance Manometer Operation	32
4.11.1	Initial Transducer Calibration	32
4.11.1.1	Set The Controller Zero (Initial Controller Setup)	32
4.11.1.2	Zero the 370 Controller with the Transducer	32
4.12	Capacitance Manometer Analog Output Signal	33
4.12.1	Capacitance Manometer Analog Output Offset Adjustment	33
4.12.2	Capacitance Manometer Analog Output Full-scale Adjustment	33
4.12.3	Capacitance Manometer Full-scale Adjustment	33
4.12.4	Convectron/Capacitance Manometer Analog Output Signal	34
4.13	Preparing for Process Control Operation	35
4.13.1	Setpoint Display and Adjustment	35
4.13.2	To Display a Setpoint	35
4.13.3	To Modify a Setpoint	35
4.14	Preparing for use of the RS-232 Computer Interface	36
4.15	Preparing for use of the RS-485 Computer Interface	36
4.16	Preparing for use of the IEEE 488 Computer Interface	37
4.17	RS-232, RS-485, and IEEE 488 Command Syntax	37
4.18	Gauge Serial Number Display and Channel Data Swapping	41
4.18.1	Stabil-Ion Gauge Serial Number Display and Channel Data Swapping	41
4.18.2	Convectron Gauge Serial Number Display and Memory Data Swapping	43

Chapter 5	Operation of a Stabil-Ion System	1
Chapter 6	Theory of Operation and Specifications	1
6.1	Stabil-Ion Gauge Theory of Operation	1
6.1.1	Operating Principles of Bayard-Alpert Ionization Gauges	1
6.1.2	X Ray Limit of Bayard-Alpert Gauges	2
6.1.3	Filaments (Cathodes) used in Bayard-Alpert Gauges	2
6.1.4	Degassing Bayard-Alpert Gauges	3
6.1.5	Stabil-Ion Gauge Specifications	3
6.2	Convectron Gauge Theory of Operation	4
6.2.1	Convectron Gauge Specifications	4
6.3	Capacitance Manometer Gauge Theory of Operation	5
6.3.1	Capacitance Manometer Gauge Specifications	5
Chapter 7	Service and Maintenance	1
7.1	Service Guidelines	1
7.2	Damage Requiring Service	2
7.3	Fault Relay	4
7.4	Electrometer Minimum Calibration Adjustment	5
7.5	Troubleshooting the Convectron Gauge Module	6
7.6	Convectron Gauge Test Procedure	6
7.7	Troubleshooting the Capacitance Manometer Module	7
7.8	Cleaning Contaminated Convectron Gauges	8
7.9	Troubleshooting the Electrometer Module	8
7.10	Overpressure Shutdown	9
7.11	Turnoff History	10
7.12	Troubleshooting the Process Control Module	11
7.13	RS-232 Troubleshooting	11
7.14	RS-485 Troubleshooting	12
7.15	IEEE 488 Troubleshooting	12
7.16	Field Installation of Modules	13
7.17	Troubleshooting Flow Charts	14
7.18	Service Form	17
Index	1

Safety Instructions

START BY READING THESE IMPORTANT SAFETY INSTRUCTIONS AND NOTES collected here for your convenience and repeated with additional information at appropriate points in these instructions.



In these instructions the word “product” refers to the 370 Stabil-Ion Vacuum Measurement System and all of its approved parts and accessories.

NOTE: These instructions do not and cannot provide for every contingency that may arise in connection with the installation, operation, or maintenance of this product. Should you require further assistance, please contact Granville-Phillips (G-P) at the address on the title page of this manual.

This product has been designed and tested to offer reasonably safe service provided it is installed, operated, and serviced in strict accordance with these safety instructions.



These safety precautions must be observed during all phases of operation, installation, and service of this product. Failure to comply with these precautions or with specific warnings elsewhere in this manual violates safety standards of design, manufacture, and intended use of the instrument. Granville-Phillips disclaims all liability for the customer's failure to comply with these requirements.

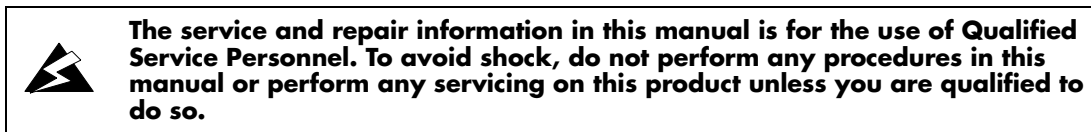

- *Read Instructions* – Read all safety and operating instructions before operating the product.
- *Retain Instructions* – Retain the Safety and Operating Instructions for future reference.
- *Heed Warnings* – Adhere to all warnings on the product and in the operating instructions.
- *Follow Instructions* – Follow all operating and maintenance instructions.
- *Accessories* – *Do not* use accessories not recommended in this manual as they may be hazardous.

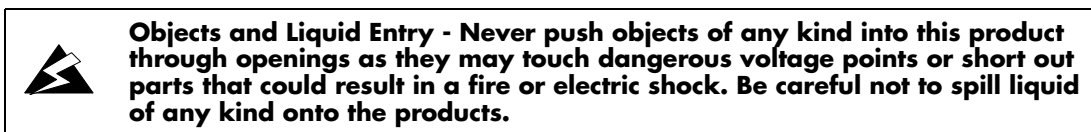

Do not substitute parts or modify instrument.



Because of the danger of introducing additional hazards, do not install substitute parts or perform any unauthorized modification to the product. Return the product to a service facility designated by Granville-Phillips for service and repair to ensure that safety features are maintained. Do not use this product if it has unauthorized modifications.

Damage Requiring Service

Disconnect the product from the wall outlet and all power sources and refer servicing to Qualified Service Personnel under the following conditions:

- a. When any cable or plug is damaged.
- b. If any liquid has been spilled onto, or objects have fallen into, the product.
- c. If the product has been exposed to rain or water.
- d. If the product does not operate normally even if you follow the operating instructions. Adjust only those controls that are covered by the operation instructions. Improper adjustment of other controls may result in damage and will often require extensive work by a qualified technician to restore the product to its normal operation.
- e. If the product has been dropped or the enclosure has been damaged.
- f. When the product exhibits a distinct change in performance. This indicates a need for service.



Replacement Parts - When replacement parts are required, be certain to use the replacement parts that are specified by Brooks Automation, Inc./ Granville-Phillips, or that have the same characteristics as the original parts. Unauthorized substitutions may result in fire, electric shock or other hazards.



Safety Check - Upon completion of any service or repairs to this product, ask the Qualified Service Person to perform safety checks to determine that the product is in safe operating order.



Finite Lifetime - After ten years of normal use or even non-use, the electrical insulation in this product may become less effective at preventing electrical shock. Under certain environmental conditions which are beyond the manufacturer's control, some insulation material may deteriorate sooner. Therefore, periodically inspect all electrical insulation for cracks, crazing, or other signs of deterioration. Do not use if the electrical insulation has become unsafe.



Be aware that when high voltage is present in any vacuum system, a life threatening electrical shock hazard may exist unless all exposed conductors are maintained at earth ground.

This hazard is not peculiar to this product.



Be aware that an electrical discharge through a gas may couple dangerous high voltage directly to an ungrounded conductor almost as effectively as would a copper wire connection. A person may be seriously injured or even killed by merely touching an exposed ungrounded conductor at high potential.

This hazard is not unique to this product.

Proper Grounding:

All components of a vacuum system used with this or any similar high voltage product must be maintained at earth ground for safe operation. The power cord of this product shall be connected only to a properly grounded outlet. Be aware, however, that grounding this product does not guarantee that other components of the vacuum system are maintained at earth ground.



Complying with the usual warning to connect the power cable only to a properly grounded outlet is necessary but not sufficient for safe operation of a vacuum system with this or any similar high voltage producing product.

Verify that the vacuum port to which the Stabil-Ion Gauge is mounted is electrically grounded. It is essential for personnel safety as well as proper operation that the envelope of the gauge be connected to a facility ground. Use a ground lug on a flange bolt if necessary.



All conductors in, on, or around the vacuum system that are exposed to potential high voltage electrical discharges must either be shielded at all times to protect personnel or must be connected to earth ground at all times.



Danger, High Voltage – The high voltages present within the Power Supply are capable of causing injury or death. To avoid electric shock, wait 3 minutes after power is removed before touching any component within the Power Supply. This will permit charged capacitors to discharge.



Danger, high voltage – 180V is present in the Power Supply, on the cable, and at the ion gauge when the gauge is turned on. Voltages as high as 850V peak are present during degas.



Do not touch the Stabil-Ion Gauge during degas operation if the Guard has been removed. Serious burns can occur.













Install suitable devices that will limit the pressure to the level that the vacuum system can safely withstand. In addition, install suitable pressure relief valves or rupture disks that will release pressure at a level considerably below the pressure that the system can safely withstand.

Suppliers of pressure relief valves and pressure relief disks are listed in the *Thomas Register* under “Valves, Relief”, and “Discs, Rupture”.

Confirm that these safety devices are properly installed before installing the product. In addition, check that (1) the proper gas cylinders are installed, (2) gas cylinder valve positions are correct on manual systems, and (3) the automation is correct on automated gas delivery systems.

Vacuum gauges with compression fittings may be forcefully ejected if the vacuum system is pressurized.

-  **Do not operate in an explosive atmosphere.**
Do not operate the product in the presence of flammable gases or fumes.
Operation of any electrical instrument in such an environment constitutes a definite safety hazard.
-  **Do not use the product to measure the pressure of explosive or combustible gases or gas mixtures. The sensor wire of the CONVECTRON Gauge normally operates at only 125 °C, but it is possible that Controller malfunction can raise the sensor temperature above the ignition temperature of combustible mixtures.**
- Danger of explosion or inadvertent venting to atmosphere exists on all vacuum systems which incorporate gas sources or involve processes capable of pressurizing the system above safe limits.**
-  **Warning - If used improperly, CONVECTRON Gauges can supply misleading pressure indications that can result in dangerous overpressure conditions within the system. For use with gases other than air or N₂, consult the gas type correction charts in Section 4.7.1 on page 4-19 or use a Memory Module programmed with data for the specific gas being used.**
-  **Using the N₂ calibration to pressurize a vacuum system above about 1 Torr with certain other gases can cause dangerously high pressures which may cause explosion of the system. See Section 4.7.1 on page 4-19 before using with other gases.**
-  **Caution: If the overpressure shutdown point is increased from the factory settings, an excess pressure rise may go undetected—resulting in possible gauge and/or vacuum system damage. Consult the factory if in doubt.**
-  **It is the installer's responsibility to ensure that the automatic signals provided by the product are always used in a safe manner. Carefully check the system programming before switching to automatic operation.**
-  **Where an equipment malfunction could cause a hazardous situation, always provide for fail-safe operation. As an example, in an automatic backfill operation where a malfunction might cause high internal pressures, provide an appropriate pressure relief device.**
-  **Do not disconnect the ionization gauge cable from either the gauge tube or controller when the ion gauge is on. The connectors are not rated to break the currents and voltages delivered to the ion gauge.**
-  **Operation of the product with line voltage other than that selected by the proper power supply switches can cause damage to the instrument and injury to personnel.**
-  **The fumes from solvents such as trichloroethylene, perchloroethylene, toluene, and acetone can be dangerous to health if inhaled. Use only in well ventilated areas exhausted to the outdoors. Acetone and toluene are highly flammable and should not be used near an open flame or energized electrical equipment.**

Certification

Brooks Automation, Inc./Granville-Phillips certifies that this product met its published specifications at the time of shipment from the factory. Brooks Automation, Inc./Granville-Phillips further certifies that its calibration measurements are traceable to the National Institute of Standards and Technology to the extent allowed by the Institute's calibration facility. See the CE Declaration of Conformity included with the Series 370 Controller for the CE tests performed.

Extended Warranty

Brooks Automation, Inc. provides an extended warranty period to five (5) years from the date of shipment for the Granville-Phillips Series 370 Controllers. The Brooks Automation, Inc. General Terms and Conditions of Sale provides the complete and exclusive warranty for Brooks Automation, Inc./Granville-Phillips products.

Service Guidelines

Some minor problems are readily corrected on site. If the product requires service, please contact our Customer Service Department at 1-303-652-4400 for troubleshooting help over the phone. If the product must be returned for service, request a Return Authorization (RA) from G-P. See the Service Form at the end of Chapter 6. Do not return products without first obtaining an RA.

Shipping damage on returned products as a result of inadequate packaging is the Buyer's responsibility.

When returning equipment to Brooks Automation, Inc./Granville-Phillips, please use the original packing material whenever possible. Otherwise, contact your shipper or Brooks Automation, Inc./Granville-Phillips for safe packaging guidelines. Circuit boards and modules separated from the controller chassis must be handled using proper anti-static protection methods and must be packaged in anti-static packaging. Brooks Automation, Inc./Granville-Phillips will supply return packaging materials at no charge upon request.

FCC Verification

This equipment has been tested and found to comply with the limits for a Class A digital device, pursuant to Part 15 of the FCC Rules. These limits are designed to provide reasonable protection against harmful interference when the equipment is operated in a commercial environment. This equipment generates, uses, and can radiate radio frequency energy and, if not installed and used in accordance with this instruction manual, may cause harmful interference to radio communications. However, there is no guarantee that interference will not occur in a particular installation. Operation of this equipment in a residential area is likely to cause harmful interference in which case the user will be required to correct the interference at his own expense. If this equipment does cause harmful interference to radio or television reception, which can be determined by turning the equipment off and on, the user is encouraged to try to correct the interference by one or more of the following measures:

- Reorient or relocate the receiving antenna.
- Increase the separation between the equipment and the receiver.
- Connect the equipment into an outlet on a circuit different from that to which the receiver is connected.
- Consult the dealer or an experienced radio or television technician for help.

Canadian Users

This Class B digital apparatus meets all requirements of the Canadian Interference-Causing Equipment Regulations.

Cet appareil numérique de la classe B respecte toutes les exigences du Règlement sur le matériel brouilleur du Canada.

UL Listed

This product, when labeled, is Listed to UL 3101 Standard for Safety, Laboratory Equipment by Underwriters Laboratories Inc. (UL).

System Components

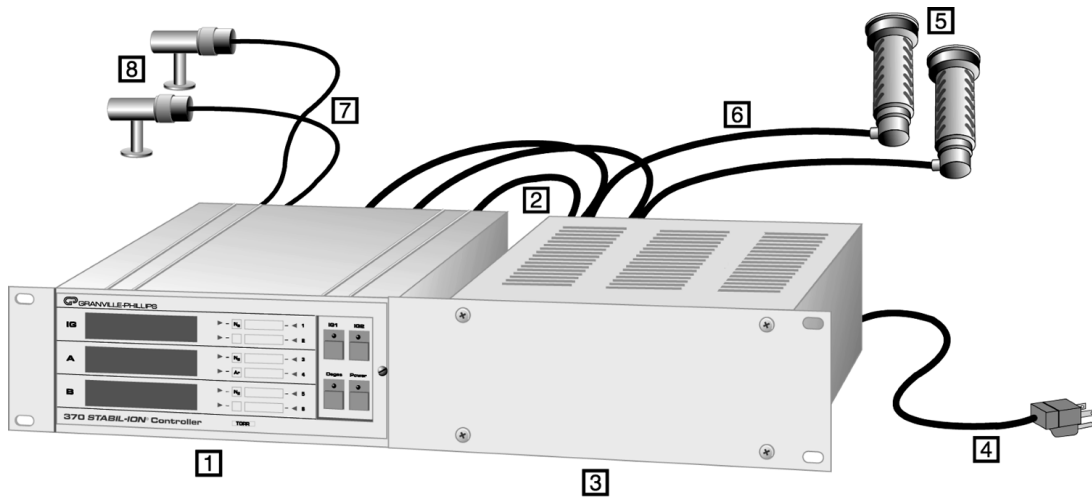

Figure 1-1 Stabil-Ion Vacuum Measuring System

- | | |
|----------------------------|--------------------------|
| 1. Stabil-Ion Control Unit | 5. Stabil-Ion Gauges |
| 2. Interconnect cable | 6. Stabil-Ion cables |
| 3. Stabil-Ion Power Supply | 7. Dual Convectron cable |
| 4. Power cable | 8. Convectron Gauges |

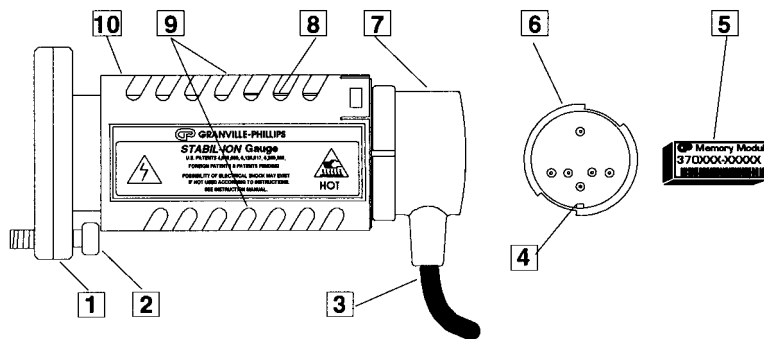

Figure 1-2 Stabil-Ion Gauge

- | | |
|-------------------------------------|----------------------|
| 1. Stabil-Ion Gauge mounting flange | 6. Pin guard |
| 2. Mounting bolt | 7. Connector shell |
| 3. Cable | 8. Serial No. tag |
| 4. Connector locating pin | 9. Ventilation slots |
| 5. Memory module | 10. Guard |

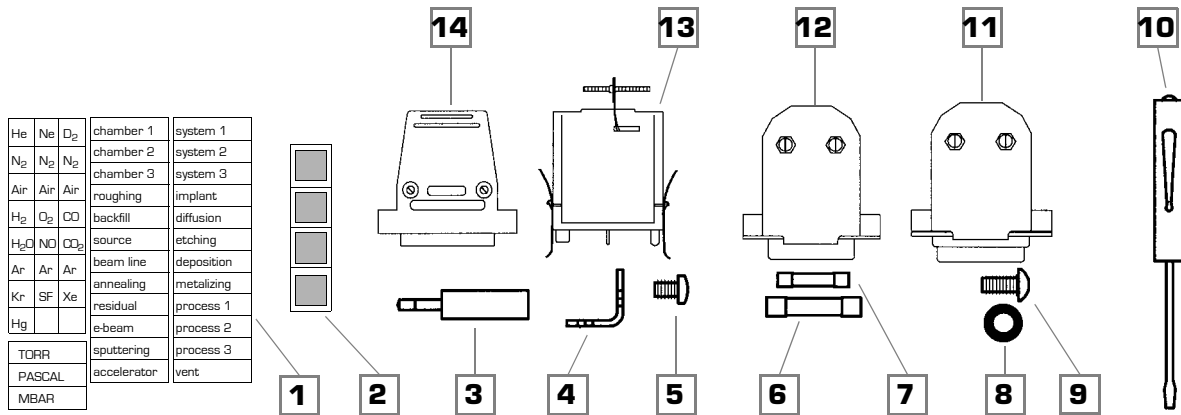

Figure 1-3 Mounting and Installing Hardware

- | | |
|----------------------------------|--------------------------------------|
| 1. Units, Gas and chamber labels | 8. Washer (4 ea.) |
| 2. Rubber stick-on feet | 9. Screw 10–32 x .50 in. (4 ea.) |
| 3. Connector, 1/8 in. phone | 10. Screwdriver |
| 4. Mounting Bracket (4 ea.) | 11. Connector, DA-26P, remote input |
| 5. Screw 10–32 x .31 in. (4 ea.) | 12. Connector, DA-15S, remote output |
| 6. Fuses: 3.0 amp, 2.0 amp | 13. Connector, process control |
| 7. Fuses: 1.6 amp, 1.0 amp | 14. Connector, DB-25S, RS-232 |

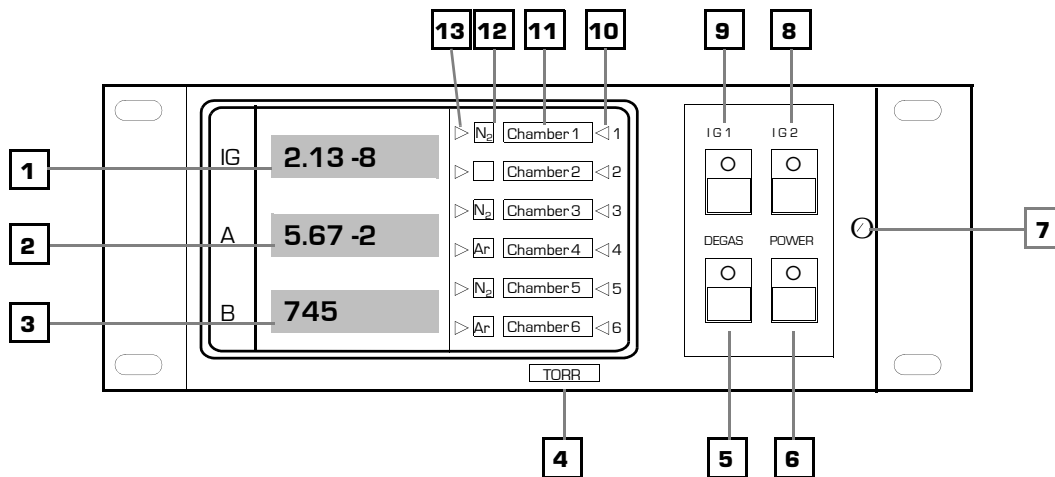

Figure 1-4 Stabil-Ion Vacuum Gauge Control Unit Front Panel

- | | |
|---|--|
| 1. Stabil-Ion display, for gauge 1 or 2 | 8. Stabil-Ion Gauge 2 power switch |
| 2. Convectron or Capacitance Manometer Gauge A display | 9. Stabil-Ion Gauge 1 power switch |
| 3. Convectron Gauge B display | 10. Process Control channel indicator lights |
| 4. Unit of measure label, Torr, mbar or Pascal, user selectable | 11. Process Control channel labels |
| 5. Degas power switch | 12. Gas selection indicator label |
| 6. Controller power switch | 13. Gas selection indicator lights |
| 7. Front door closure | |

Open the front panel door to access these controls.

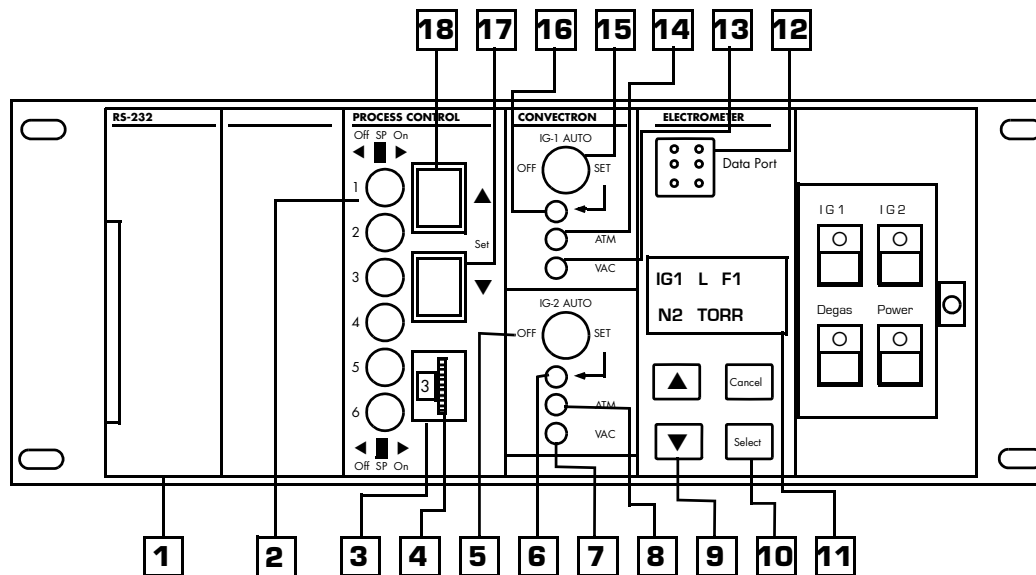

Figure 1-5 Stabil-Ion Vacuum Gauge Control Unit Front Panel (door open)

- | | |
|--|--|
| 1. RS-232, RS-485, or IEEE 488 Computer Interface Module | 10. Select/Cancel switches used during setup |
| 2. Process control channel setpoint override switch | 11. Electrometer Module display |
| 3. Process control channel indicator | 12. Data port for Calibration Memory |
| 4. Process control channel selector thumbwheel | 13. Vacuum zero adjustment, Convectron Gauge A |
| 5. Auto-on switch, IG2 | 14. Atmosphere adjustment, Convectron Gauge A |
| 6. Auto-on adjustment, IG2 | 15. Auto on switch, IG1 |
| 7. Vacuum zero adjustment, Convectron Gauge B | 16. Auto on adjustment, IG1 |
| 8. Atmosphere adjustment, Convectron Gauge B | 17. Process control setpoint pressure down push-button |
| 9. Up/Down switches used for menu and parameter selection during setup | 18. Process control setpoint pressure up push-button |

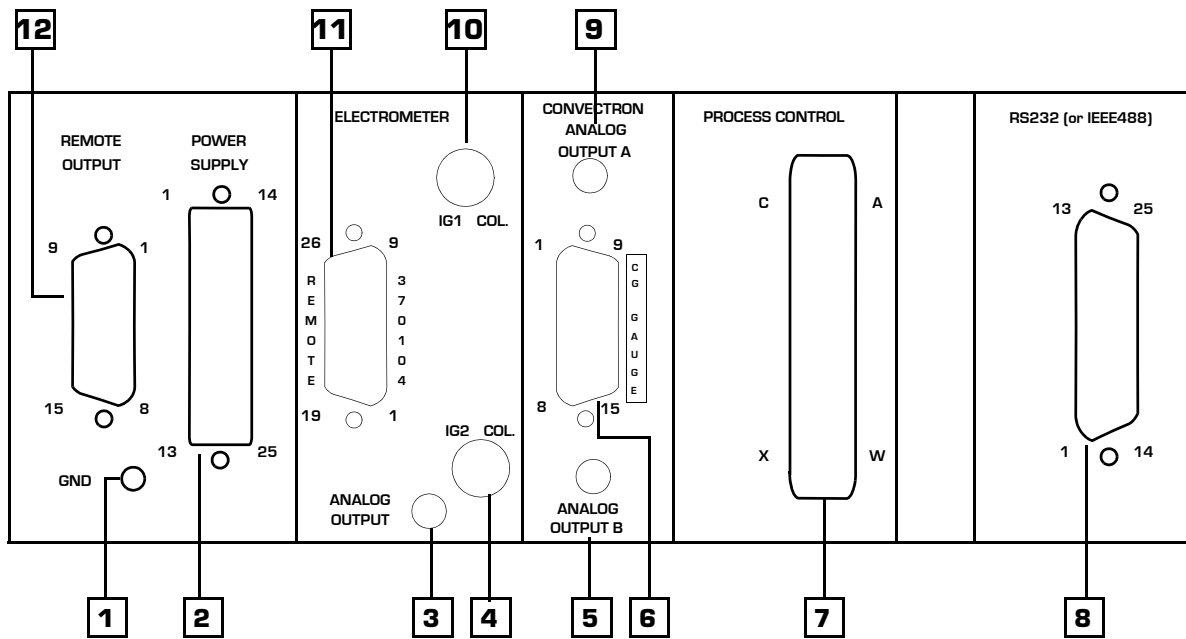

Figure 1-6 Stabil-Ion Vacuum Gauge Control Unit Rear Panel

- | | |
|---|---|
| <ol style="list-style-type: none"> 1. Grounding lug to be connected to earth ground with #12 AWG conductor 2. Interconnect cable connection from Power Supply 3. Connector for IG analog output voltage 4. Collector connector for Stabil-Ion Gauge 2 5. Connector for analog output voltage from Convectron Gauge B 6. Connector for Dual Convectron Gauge Cable | <ol style="list-style-type: none"> 7. Connector for Process Control relay contacts 8. Connector for RS-232, RS-485, or IEEE 488 9. Connector for analog output voltage from Convectron Gauge A 10. Collector connector for Stabil-Ion Gauge 1 11. Connector for remote parameter selection inputs 12. Connector for remote output relay contacts from Stabil-Ion Gauge 1 and Stabil-Ion Gauge 2 |
|---|---|

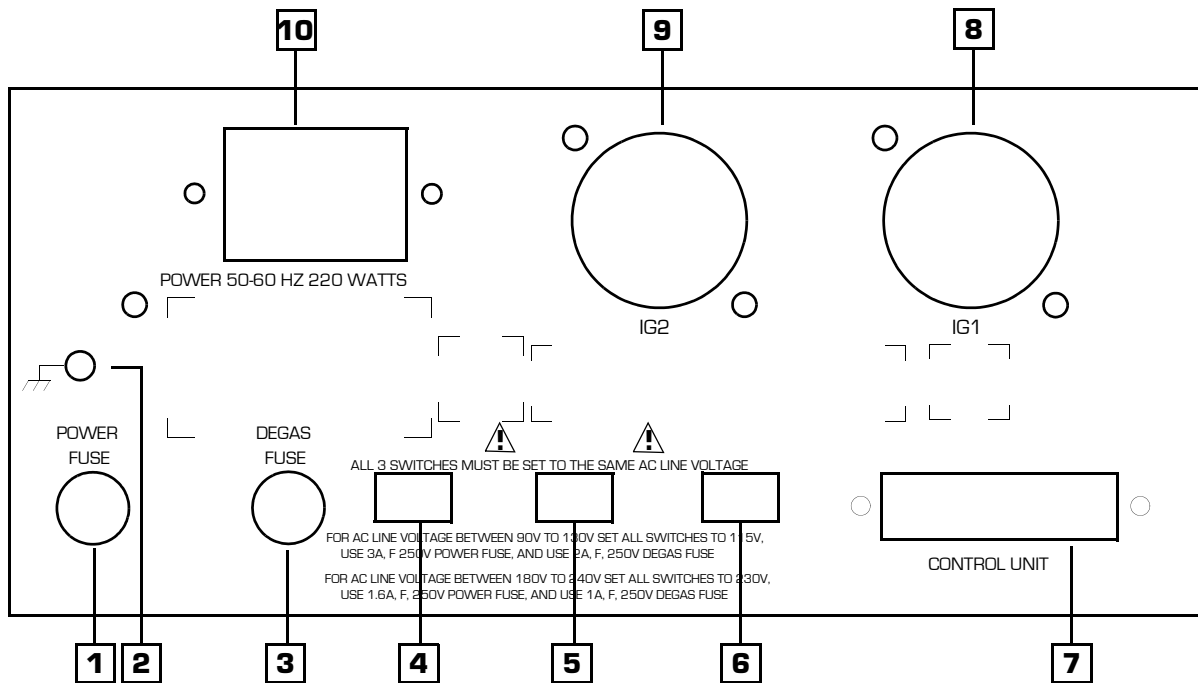

Figure 1-7 Stabil-Ion Power Supply

1. Line power fuse
2. Grounding lug (connect to earth ground with #12 AWG conductor)
3. Degas power fuse
4. Line voltage selector switch
5. Line voltage selector switch
6. Line voltage selector switch
7. Connector for interconnect cable to Control Unit
8. Connector for Stabil-Ion Gauge 1
9. Connector for Stabil-Ion Gauge 2
10. Connector for power cable

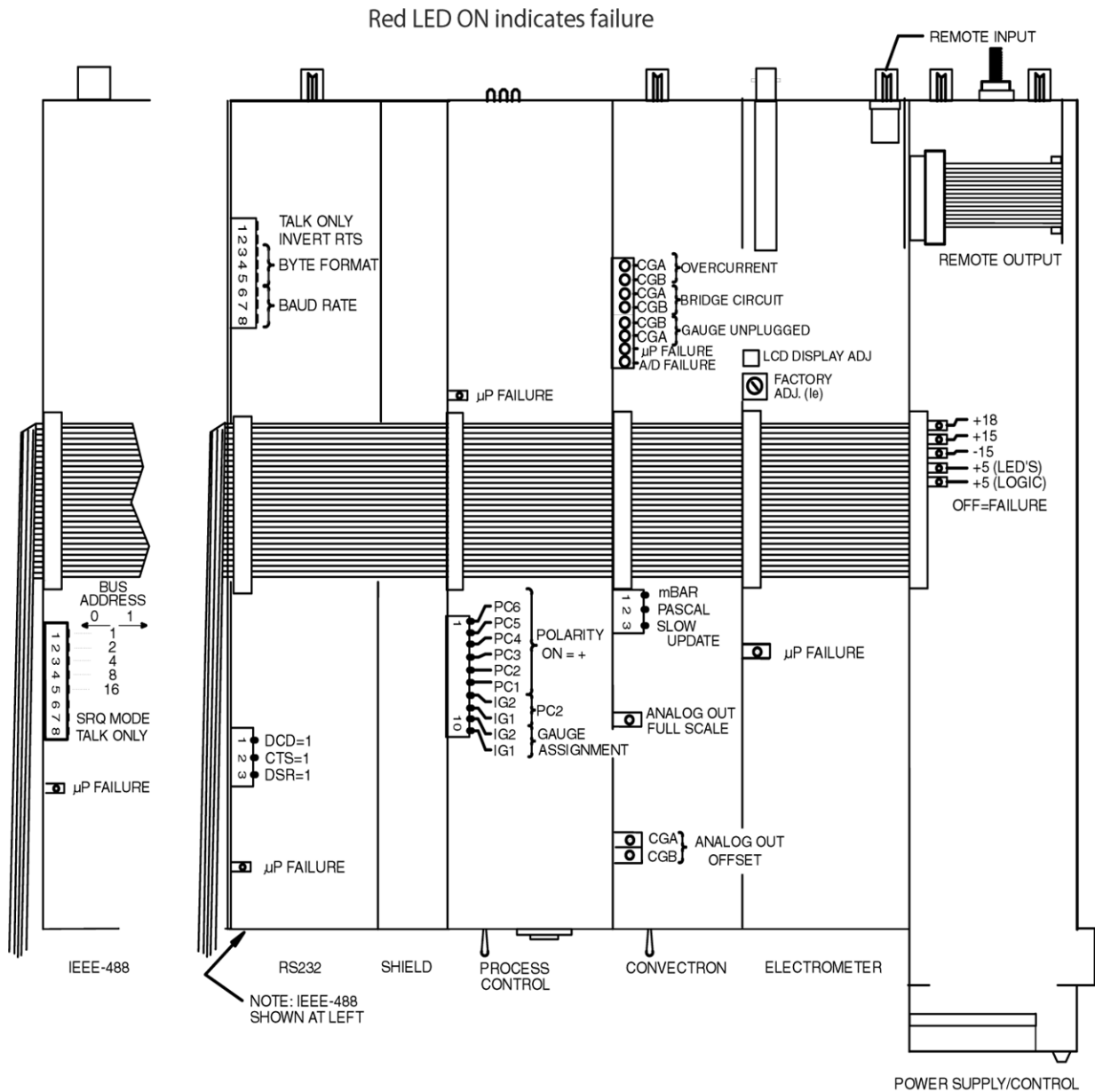

Figure 1-8 Top View of Stabil-Ion Vacuum Gauge Control Unit (cover and door removed) ¹

1. For completeness, all available capabilities are assumed present. Not all capabilities may be present in the product you have specified.

Initial Setup Procedures

2.1 Control Unit Option Module Setup

1. Open the front panel door and determine if any of the following options are installed:
 - Convectron Gauge
 - Convectron/Capacitance Manometer Gauge
 - Process Control
 - RS-485 Computer Interface
 - RS-232 Computer Interface
 - IEEE 488 Computer Interface

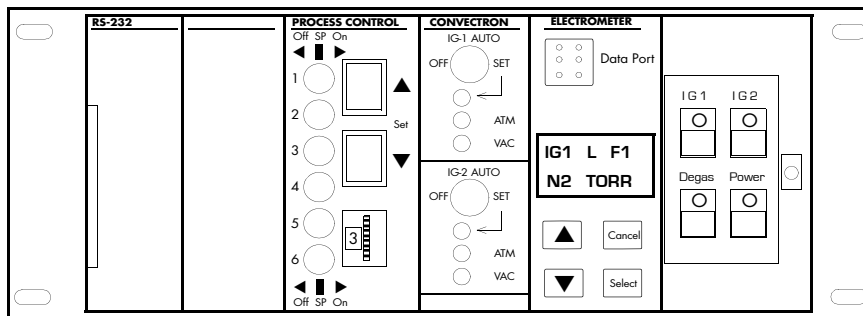

Figure 2-1 Control Unit Front Panel (with Door Open) Showing Location of Computer Interface and Process Control Modules

2. If none of the above options are present skip to Section 2.2 Power Supply Setup on page 2-15.
3. If one or more of the above options is present you may find it necessary to re-configure certain switches within the Control Unit. See Section 2.1.1 on page 2-2 and the following sections for further details.

Review Sections 2.1.2, 2.1.3, 2.1.4, 2.1.5, and 2.1.6 for the factory default settings for the switches or settings on these options to determine if any need changing. Now is a convenient time to make any required switch changes before mounting the Control Unit in its desired location.

2.1.1 Top Cover Removal

1. With power off, remove any cables from Control Unit rear panel.
2. Observe antistatic precautions to avoid damaging static sensitive components inside the chassis. Use a grounded, conductive work surface. Do not handle integrated circuits (IC) devices more than necessary, and only when wearing a high impedance ground strap. (A high impedance helps protect human life in case of inadvertent contact with high voltage.)
3. Remove the four Phillips head screws identified in Figure 2-2. If the unit is equipped with a rear bracket instead of one rear screw, unfasten the Phillips head screw on the bracket, and slide off the bracket
4. Lift off top cover.

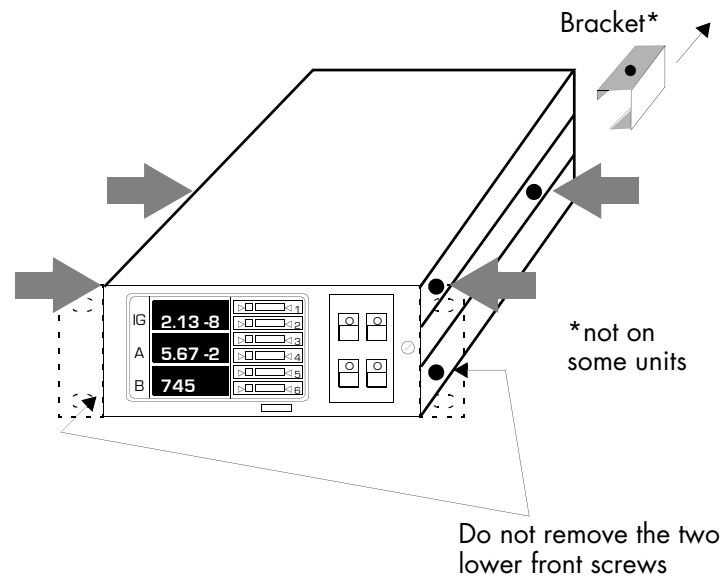

Figure 2-2 Location of Screws for Removal of Top Cover

2.1.2 Convectron / Capacitance Manometer Pressure Units Setup

1. If you wish to change the units of measure displayed for the Convectron gauge or a Capacitance Manometer, change the settings of the units of measure switches on the module as shown in Figure 2-3 and in Figure 2-4.

NOTE: This change only affects units of measure for a Convectron Gauge or a Capacitance Manometer. To change the Stabil-Ion Gauge pressure display units of measure, see Section 4.3.4.1 on page 4-12.

Figure 2-3 Control Unit Top View, Cover Off, Showing Locations of Switches for Pressure Display Units of Measure Selection

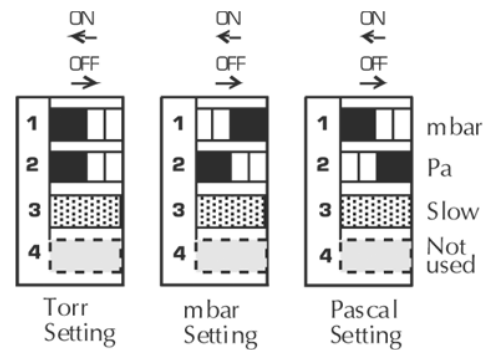
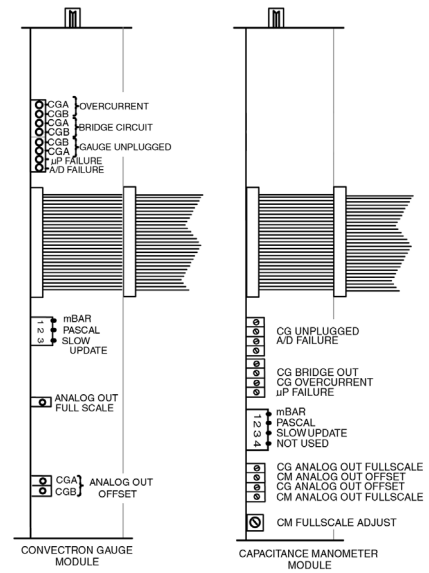

Figure 2-4 Pressure Display Units of Measure Switch Settings

2. To change the units of measure label, open the door and lift the label card from its slot in the top of the front panel. See Figure 2-5. Units of measure labels are included in the mounting hardware kit.

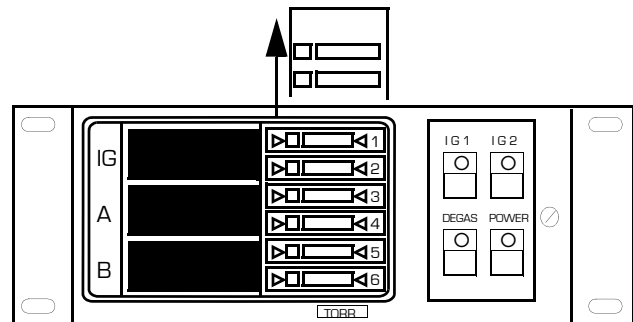



Figure 2-5 Control Unit Front Panel Showing Removal of Units of Measure Label Card

2.1.3 Process Control Setup

 **It is the installer's responsibility to ensure that the automatic signals provided by the product are always used in a safe manner. Carefully check the system programming before switching to automatic operation.**

 **Where an equipment malfunction could cause a hazardous situation, always provide for fail-safe operation. As an example, in an automatic backfill operation where a malfunction might cause high internal pressures, provide an appropriate pressure relief device.**

1. If you do not have process control capability skip to Section 2.1.4 on page 2-8.
2. Use the catalog number on the rear of the Process Control module together with Figures 2-6 and 2-7 to identify the process control capability installed in your unit.
3. Even if the control logic is simple and obvious, we recommend that you develop a logic diagram of the process control function.
4. Prepare a specification table which lists the proposed pressure setting, system measurement point, and relay status for each Process Control setpoint.
5. Draw a circuit schematic which specifies exactly how each piece of system hardware will be connected to the Process Control relays.

Do not exceed the relay ratings:

Table 2-1 Relay Ratings

Relay Configuration	SPDT (single pole, double throw)
Relay Contact Rating	5 A, 60 Vdc resistive load, 30 V rms (42.4 Vpk)
Relay Contact Type	5 A (gold plated for low level switching)

NOTE: If the relay contacts are used to switch high currents, the gold plating may be consumed. This may make the contacts unsuitable for low level signal switching in the future.

6. Attach a copy of the Process Control circuit diagram to this manual for future reference and troubleshooting.
7. The required process control connections may be made later. See Section 3.6 on page 3-8.
8. If application assistance is desired, please contact a G-P Application Engineer at the number listed on the inside cover of this manual.

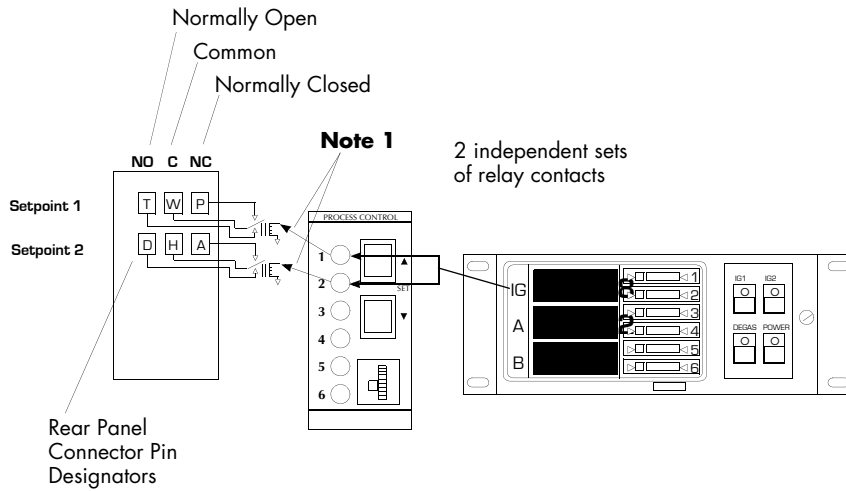

Figure 2-6 Two Channel Process Control - Cat. No. 370108

NOTE 1:

Setpoint 1 is user-assignable to IG1 or IG2, or IG1 and IG2.

Setpoint 2 is user-assignable to IG1 or IG2, or IG1 and IG2 independent of how Setpoint 1 is assigned.

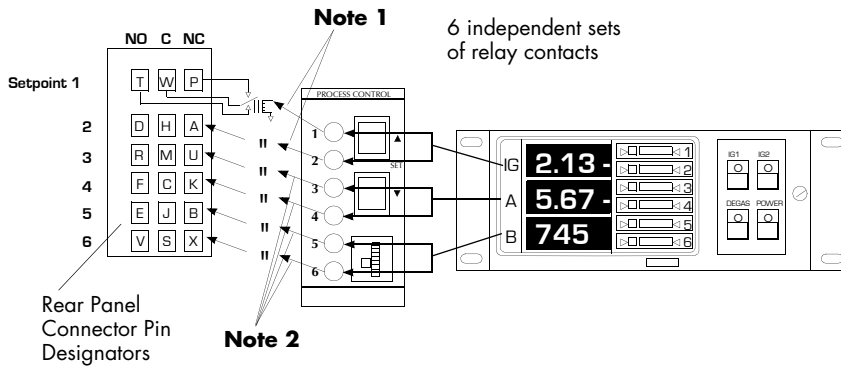

Figure 2-7 Six Channel Process Control - Cat. No. 370107

NOTE 2:

Setpoints 3 and 4 are factory assigned to Convectron Gauge A.

Setpoints 5 and 6 are factory assigned to Convectron Gauge B.

2.1.3.1 Ion Gauge Assignment for Process Control

A maximum of 6 process control setpoints are available depending on the particular option you have specified. A setpoint is defined as the combination of vacuum gauge indication setpoint circuitry and the associated relay which is actuated when the pressure indication corresponds to the setpoint.

Figure 2-8 Partial Top View of Process Control Module

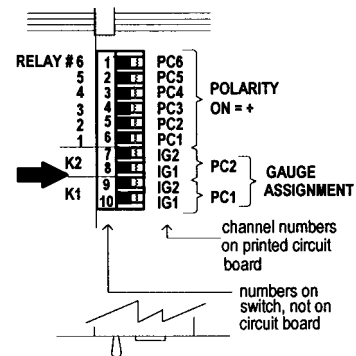

Process Control setpoints 1 (PC1) and 2 (PC2) are controlled by the ionization gauge or gauges. Setpoint 1 operates relay 1. Setpoint 2 operates relay 2. Relays 1 and 2 are also shown as K1 and K2 on the printed circuit board for reference during IG assignment. IG1, IG2, or both can be assigned to operate either setpoint 1 or 2. Use Table 2-2 to assign the IG's to the setpoints.

Table 2-2 IG Process Control Channel Switch Settings

Switch Settings	Function	Switch Settings	Function
	Setpoint 1 can turn <u>on</u> when IG1 is ON or when IG2 is ON. (factory setting)		Setpoint 2 can turn <u>on</u> when IG1 is ON or when IG2 is ON. (factory setting)
	Setpoint 1 can turn <u>on</u> when IG1 is ON and will turn <u>off</u> when IG2 is ON.		Setpoint 2 can turn <u>on</u> when IG1 is ON and will turn <u>off</u> when IG2 is ON.
	Setpoint 1 will turn <u>off</u> when IG1 is ON and can turn <u>on</u> when IG2 is ON.		Setpoint 2 will turn <u>off</u> when IG1 is ON and can turn <u>on</u> when IG2 is ON.
	Setpoint 1 will always be <u>off</u> .		Setpoint 2 will always be <u>off</u> .

2.1.3.2 Relay Polarity Setting

The relays can be set to activate as pressure either rises above or falls below the setpoint. A DIP switch is provided for each setpoint. Refer to the numbers on the switch for the setpoint number. Use Table 2-3 to assign the relay polarity settings.

The switches are factory preset as shown on Table 2-3 for relay activation below the pressure setpoint. This is most commonly desired when you want the relay to be de-energized under a high pressure condition.

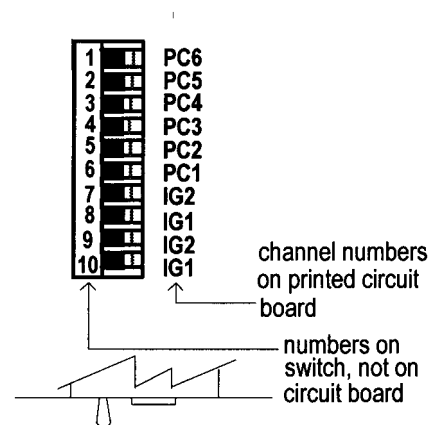
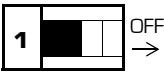
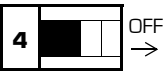
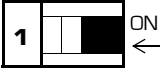
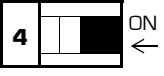
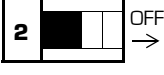
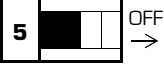
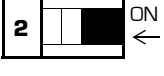
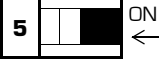
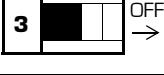
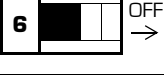



Figure 2-9 Partial Top View of Process Control Module

Table 2-3 Relay Polarity Switch Settings

Switch Settings	Channel Activated	Pressure Indication Relative to Setpoint	Switch Settings	Channel Activated	Pressure Indication Relative to Setpoint
	6	below*		3	below*
	6	above		3	above
	5	below*		2	below*
	5	above		2	above
	4	below*		1	below*
	4	above		1	above

* factory setting

2.1.3.3 Process Control Tips

1. The process control override switches can be used to hold relays on or off during initial turn on or during non-typical process conditions.
2. When IG1 and IG2 are off, setpoints 1 and 2 are inoperative.
3. When Convectron Gauges are disconnected, setpoints 3-6 are inoperative.
4. The status of relays 1 and 2 will not change during degas. They function as if the pressure reading was frozen when degas began.
5. Relay actuation occurs when the second digit pressure indication differs from the setpoint value by one display unit. A 10% hysteresis is automatically programmed into each setpoint for returning pressures. Table 2-4 illustrates this using an assumed setpoint pressure and assuming the polarity is set for falling pressure activation.

Table 2-4 Setpoint Hysteresis

Setpoint Pressure	Pressure Change	Relay Actuation Pressure
6.30×10^{-7}	Falling	6.29×10^{-7}
6.30×10^{-7}	Rising	$6.30 \times 10^{-7} + 10\% = 7.00 \times 10^{-7}$

2.1.4 RS-232 Computer Interface Setup

If your Control Unit does not have this capability, skip to Section 2.1.5 on page 2-12.

This available capability permits data output to, and gauge control by, a host computer. Output is either by a command-response mechanism or by a talk-only mode which is invoked via a switch on the RS-232 board. If you have this module in your unit, configure it to your system requirements by setting the switches as directed in Section 2.1.4.1 on page 2-8.

A variety of baud rates and byte framing options are available, as well as switches to force the handshake lines to an “always true” condition.

Stabil-Ion System RS-232 factory defaults are:

- 9600 BAUD, 8 data bits, no parity, 1 stop bit;
- DCD, CTS, and DSR forced “true”.

The interface protocol is set using 8 switches. Refer to Figures 2-10, 2-11, and 2-12 for switch numbering.

NOTE: Internal switches are read upon 370 power up. Changes in settings will take effect upon next power-up cycle.

2.1.4.1 Selecting the Byte Format

2.1.4.1.1 Baud Rate

Dip switches 6-8 may be used to set the baud rate. The settings are:

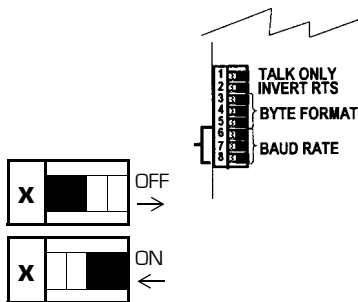

Table 2-5 Baud Rate

S6	S7	S8	Baud Rate
On	On	On	9600*
On	On	Off	4800
On	Off	On	2400
On	Off	Off	1200
Off	On	On	600
Off	On	Off	300
Off	Off	On	150
Off	Off	Off	75

* factory setting

Figure 2-10 Partial Top View of Process Control Module

2.1.4.1.2 Character Framing

Switches 3-5 control the number of characters, polarity, and number of stop bits:

Table 2-6 Character Framing

S3	S4	S5	Character Bits	Parity	Stop Bits
On	On	On	8	None	2
On	On	Off	8	Even	2
On	Off	On	8	Odd	1
On*	Off*	Off*	8*	None*	1*
Off	On	On	7	Even	1
Off	On	Off	7	Odd	1
Off	Off	On	7	Even	2
Off	Off	Off	7	Odd	2

* factory setting

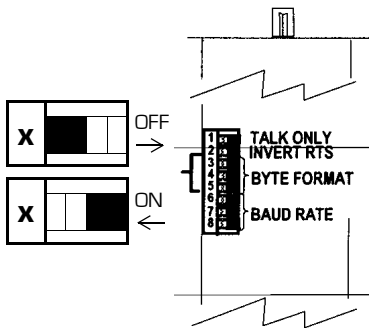

Figure 2-11 Partial Top View of RS-232 Module

2.1.4.1.3 Talk-Only Mode

The pressure data from all three displays will be output in a single message string, separated by commas, approximately every 5 seconds. If the Convectron Module is not present, only the ion gauge pressure will be output.

Table 2-7 Talk-Only Mode

S1	Mode
Off	Talk-only
On	Command-response*

*factory setting

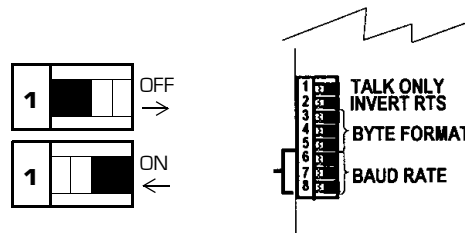

Figure 2-12 Partial Top View of RS-232 Module

2.1.4.2 Handshaking

Table 2-8 Inputs to 370 Controller

Line	Pin	Description	Internal Switch Function	Factory Setting
CTS & DSR	5 6	CLEAR to SEND and DATA SET READY: When used, both must be TRUE in order for 370 to send the next byte in its message or data.	CTS=1 and DSR=1: When ON, forces the functions TRUE and thus assumes host is always ready to receive.	Both ON
DCD	8	DATA CARRIER DETECT: Must be TRUE at the time each character is received or that character will be ignored by 370.	DCD=1: When ON, forces DCD function TRUE so 370 will receive all characters sent to it (as long as RTS is in de-asserted state).	ON

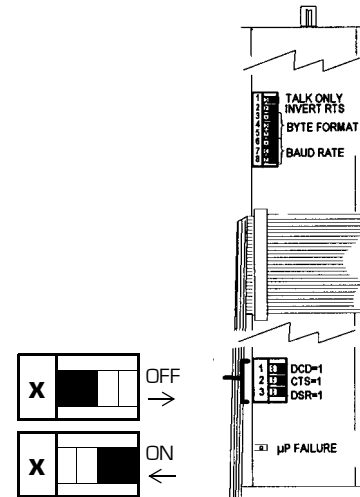

Figure 2-13 Top View of RS-232 Module

Table 2-9 Outputs from 370 Controller

Line	Pin	Description	Internal Switch Function	Factory Setting
RTS	4	REQUEST TO SEND: De-asserted by the Controller on power-up. Asserted by the Controller upon receipt of a message terminator as a hold off to prevent the host computer from attempting to transmit data until the message just received has been parsed and a reply has been output. De-asserted after transmitting the terminator of the Controller's response to that message.	INVERT RTS: When OFF inverts the polarity of the RTS line allowing nonstandard connection directly to host computer CTS line. When ON, set to operate as a modem line per RS-232 standard.	ON
DTR	20	Always asserted by the Controller. A "power on" indication.		

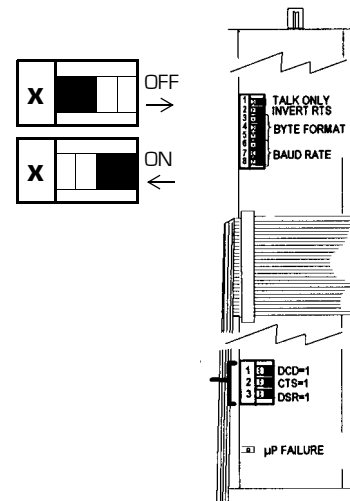

Figure 2-14 Top View of RS-232 Module

NOTE: When the Controller receives a start bit on the received data line, it will input and buffer a character. The Controller will continue to receive and buffer characters until the terminator (LF) is received.

2.1.5 RS-485 Computer Interface Setup

If your Series 370 Stabil-Ion Gauge Controller does not have this capability, skip to Section 2.1.6 on page 2-14.

The RS-485 communications option for the Series 370 Stabil-Ion Gauge Controller permits data output to, and gauge control by, a host computer using RS-485 digital communications. Communications handshake is by a command-response mechanism.

A variety of baud rates and byte framing options are available. The RS-485 byte format is configured to your system requirements using configuration switches located on the option board. These switches are accessed by removing the controller top chassis cover.

The RS-485 factory defaults are:

- 9600 BAUD, 8 character bits, no parity, 1 stop bit, Address = 01

Internal switches are read upon power up. Changes in settings will take effect upon next power-up cycle.

2.1.5.1 RS-485 Address

The address dial on the RS-485 module on the back of the controller and Switch S1 determine the controller's RS-485 address. This address can be any hex code from 00 to FF.

The address dial on the RS-485 module on the back of the controller determines the value of the least significant digit and the S1 switches determine the value of the most significant digit. The S1 switch positions are binary and the weight of each switch when OFF is given in Table 2-10.

To prevent data contentions, no two RS-485 nodes should be set with the same address. It is not recommended that address 00 be used because some manufacturers use this address for configuration.

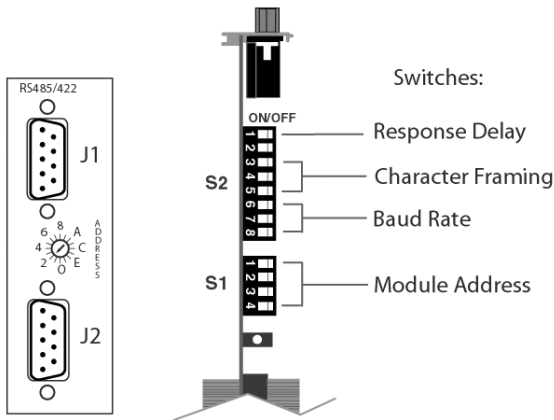

Figure 2-15 Back Panel and Top View of RS-485 Module

Table 2-10 Switch Weight When OFF

Switch	Weight
S1.1	10 Hex
S1.2	20 Hex
S1.3	40 Hex
S1.4	80 Hex

2.1.5.2 Response Delay for the RS-485 Interface

Switch S2.1, Figure 2-15, enables a delay of the response from the module of 10 to 13 MS + 10 bit times when OFF. When S2.1 is ON, the delay is greater than 700 microseconds. The factory default setting is ON, with a delay greater than 700 microseconds.

2.1.5.3 Selecting the Byte Format for RS-485 Communications

2.1.5.3.4 Baud Rate

Baud rate for the RS-485 communications is determined by the settings of switches S2.6, S2.7 and S2.8. See Figure 2-15. Table 2-11, below, defines the baud rate base on the switch settings. The factory default baud rate setting is 9600.

Table 2-11 Baud Rate Switch Settings

S2.6	S2.7	S2.8	Baud Rate
ON*	ON*	OFF*	9600*
ON	OFF	ON	4800
ON	OFF	OFF	2400
OFF	ON	ON	1200
OFF	ON	OFF	600
OFF	OFF	ON	300
OFF	OFF	OFF	150

2.1.5.3.5 Character Framing for the RS-485 Computer Interface

Character framing for the RS-485 computer interface is determined by setting switches S2.3, S2.4, and S2.5. See Figure 2-15. Table 2-12 below defines the character bits, parity, and stop bits based on the switch settings. The factory default setting is S2.3 On, S2.4 Off, and S2.5 Off - Character bits set to 8, Parity None, and Stops bits at 1.

Table 2-12 Character Framing Switch Settings

S2.3	S2.4	S2.5	Character Bits	Parity	Stop Bits
ON	ON	ON	8	None	2
ON	ON	OFF	8	Even	1
ON	OFF	ON	8	Odd	1
ON	OFF	OFF	8*	None*	1*
OFF	ON	ON	7	Even	1
OFF	ON	OFF	7	Odd	1
OFF	OFF	ON	7	Even	2
OFF	OFF	OFF	7	Odd	2

* factory setting

2.1.6 IEEE 488 Computer Interface Setup

If your Control Unit does not have this capability, skip to Section 2.1.7 on page 2-15.

This available capability permits data output to, and gauge control by, a host computer. Output is either by a command-response mechanism or by a talk-only mode which is invoked via a switch on the IEEE 488 board. If you have this capability in your unit, configure it to your system requirements by setting the switches as directed below.

NOTE: Internal switches are read upon 370 power up. Changes in settings will take effect upon next power-up cycle.

2.1.6.1 Selecting the Interface Bus Address

Refer to Figure 2-16 and locate switches 1 through 5. Each instrument on the IEEE 488 bus has an address from 0 to 30. The address for this product is set at the factory to "8". The user must ensure that every device on the bus has a unique address. To select an address, switches 1 through 5 are adjusted according to binary weights:

Table 2-13 Interface Bus Address Values When OFF

Switch Number	5	4	3	2	1
Value when OFF	16	8	4	2	1

Examples:

Table 2-14 Example Switch Settings

Switch Number	5	4	3	2	1	Address
Setting	On	Off	On	On	On	8*
	On	On	Off	Off	Off	7
	Off	Off	Off	On	On	28

* Factory default setting

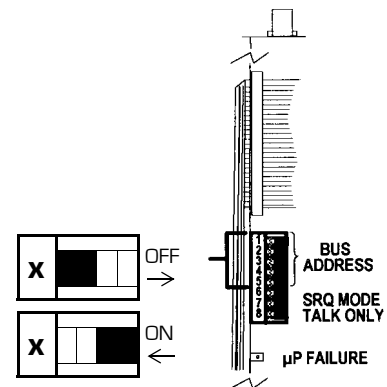

Figure 2-16 Top View of IEEE 488 Module

2.1.6.2 Talk-Only Mode

Switch 8, if set to **off** during power up, places the interface in talk-only mode. The pressure data from all three displays will be output in a single message string, separated by commas, approximately every 5 seconds. If no Dual Convectron Gauge module is present, only the ion gauge pressure will be output. The factory default is talk-only disabled (switch 8 **on**).

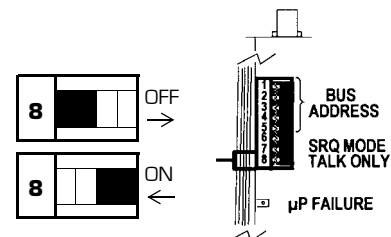

Figure 2-17 Top View of IEEE 488 Module

2.1.6.3 SRQ Mode

Switch 7, if set to **off** during power up, tells the interface to generate an SRQ interrupt and expect a serial poll before every message output. The SRQ bit will be released when there is a Serial Poll or when the message is read. The factory default is SRQ mode disabled (switch 7 **on**). The serial poll response byte will contain a 1 in bit 4 (this bit is also the MAV [message available] bit). Bit 6 will be set if an error has occurred. In this case the pending message will be an error message.

Switch 6 is not used.

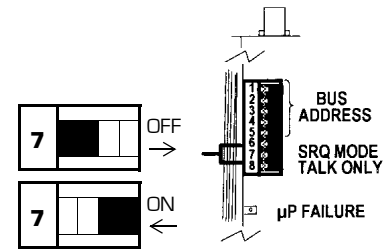

Figure 2-18 Top View of IEEE 488 Module

2.1.7 Replacing Control Unit Cover

Assuming you have completed the above instructions, the Control Unit setup is now complete. Replace the top cover. Make sure the door hinge pin is seated correctly. Replace the four top cover Phillips head screws (or three screws plus bracket screw).

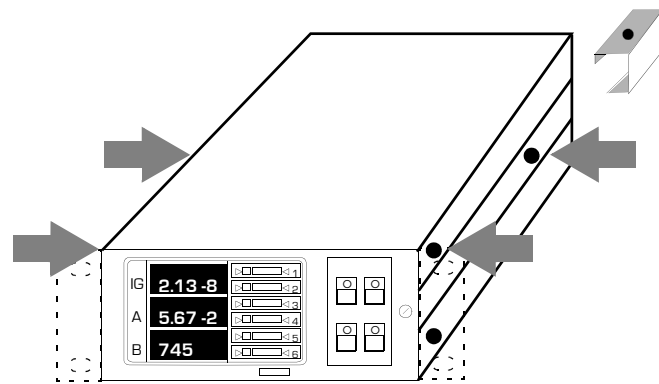

Figure 2-19 Location of Screws for Replacing Top Cover

2.2 Power Supply Setup

1. With all cables disconnected, check to see that the line voltage selector switches on the back of the power supply are set to local line voltage. Incorrect settings may cause extensive damage to the product.

AC Line Voltage between 90V to 130V

For AC line voltage between 90V to 130V set all switches to 115V as shown to the right. Use 3A, F, 250V Power Fuse, and use 2A, F, 250V Degas Fuse (see Note 1).

100/110/115/117/120 V 50/60 Hz



Replacement fuses are available from the vendors below, or from Granville-Phillips at the address on the title page of this manual.

NOTE 1: (115V Nom) Power Fuse is: Littelfuse #312-003, or BUSS #AGC-3, or GP #009325

Degas Fuse is: Littelfuse #312-002, or BUSS #AGC-2, or GP #009324

When going from 230V to 115V, two new fuseholders are required: SHURTER #0131.1666 or GP #006966

AC Line Voltage between 180V to 240V

For AC line voltage between 180V to 240V set all switches to 230V as shown to the right. Use 1.6A, F, 250V Power Fuse, and use 1A, F, 250V Degas Fuse (see Note 2).

200/208/220/230 V 50/60 Hz



Replacement fuses are available from the vendors below, or from Granville-Phillips at the address on the title page of this manual.

NOTE 2: (230V Nom) Power Fuse is: Littelfuse #21601.6, or SHURTER #FSF034.1518, or GP #009323

Degas Fuse is: Littelfuse #217001, or SHURTER #FSF034.1516, or GP #009322

When going from 115V to 230V, two new fuseholders are required: SHURTER #031.1663 or GP #006965

2. Replace the fuses whenever the switch settings are changed with correct fuse values as indicated on the power supply panel. New fuse holders may be required.
3. Do not connect power cables until the Installation Instructions in Chapter 3 are completed.
4. The 370 VGC is supplied with a convenient IEC 320 AC main connection receptacle which allows selection of a detachable line cord to match your available main power.

Installation



It is the installer's responsibility to ensure that the automatic signals provided by the product are always used in a safe manner. Carefully check the system programming before switching to automatic operation.



Where an equipment malfunction could cause a hazardous situation, always provide for fail-safe operation. As an example, in an automatic backfill operation where a malfunction might cause high internal pressures, provide an appropriate pressure relief device.

3.1 Gauge Installation Tips

For best results locate pressure gauges close to the point where pressure is to be measured. Gas sources, long tubulation or other constrictions can cause large errors in indication. Note that if placed near the pump, the pressure in the gauge may be considerably lower than in the rest of the system. If placed near a gas inlet or source of contamination, the pressure in the gauge may be much higher.

To minimize temperature effects, locate pressure gauges away from internal and external heat sources in a region where the ambient temperature is reasonably constant.

Parts of the gauge can get quite hot during degassing, especially if there is poor ventilation. This will not damage the gauge. However, care should be taken to prevent low temperature rated materials such as plastic wire insulation from touching hot parts of the gauge.

3.1.1 EMC Compliance

In order to comply with the standards for immunity as called for by the EMC Directive, careful consideration to grounding and shielding of instrumentation cables is required. User-supplied cables must have the drain shield of the cable connected to chassis ground. Immunity to radiated and conducted RF energy in industrial environments will depend on cable construction and routing. The VGC system will perform within the typical uncertainty of a Stabil-Ion Gauge system when subjected to industrial levels of RF energy.

Snap-on ferrite sleeves (G-P P/N 013746, 4 ea. provided) must be installed on the ion gauge cable at both the gauge tube end and Controller end of the cable. Failure to install these ferrite suppression cores may result in non-compliance with the EU EMC Standards for Industrial Level Immunity.

3.1.2 Cable Installation Statement

It is intended that all wiring either to or from the Stabil-Ion Gauge Controller unit, whether supplied by Brooks Automation, Inc./Granville-Phillips or not, be installed in accordance with the safety requirements of NEC/NFPA 70. Cables provided by Brooks Automation, Inc./Granville-Phillips for connection to sensors or transducers is, at a minimum, designed for use as Appliance Wiring Material (UL category AVLV2), and is constructed of appropriate material and dimensions for the voltages and currents provided by the Stabil-Ion Gauge Controller unit. It is emphasized that it is the user's responsibility to install cables to/from the Stabil-Ion Gauge Controller unit, whether provided by Brooks Automation, Inc./Granville-Phillips, or not, in accordance with the applicable local, state, and national safety requirements.

Raceway and/or conduit may be needed for certain installations.

3.1.3 Environmental Conditions

Indoor Use.

Altitude up to 2000 meters.

Temperature 0 °C to 40 °C.

Maximum relative humidity 80% for temperatures up to 31 °C decreasing linearly to 50% relative humidity at 40 °C.

Transient overvoltages according to INSTALLATION CATEGORY (over-voltage category) II.

POLLUTION DEGREE 2 in accordance with IEC664.

3.2 Stabil-Ion Gauge Installation



Verify that the vacuum port to which the Stabil-Ion Gauge is mounted is electrically grounded. It is essential for personnel safety as well as proper operation that the envelope of the gauge be connected to a facility ground. Use a ground lug on a flange bolt if necessary.

- The Stabil-Ion Gauge is double packaged at the factory for cleanroom compatibility. To reduce the chance of contamination, do not remove a Stabil-Ion Gauge from its inner bag until moments before it is to be connected to the vacuum system.

NOTE: The Stabil-Ion Gauge is packaged with its corresponding Memory Module containing data for that specific gauge. Take note of the Serial No. of the Gauge and record it before mounting.



Protect the Memory Module from static electricity. Touch a grounded, unpainted metal surface on the Stabil-Ion Control Unit and then touch the surface of the anti-static bag before removing the Memory Module from its bag.

- Any mounting orientation may be used. However, to minimize the possibility of excessive temperature at the electrical connector when degassing, it is best not to install the Stabil-Ion Gauges with the electrical connector above the gauge. If it is necessary to install the gauge with the connector on top, degas time must be limited to 10 minutes/hour. See Section 4.3.4.2 on page 4-12. When mounting horizontally, the ventilation slots in the Guard will be oriented for best cooling if the gauge is installed with the locating key in the pin guard on the bottom. See Figure 3-1 and Figure 3-2. Note in Figure 3-2 that the cable will exit in the direction the locating key is oriented.

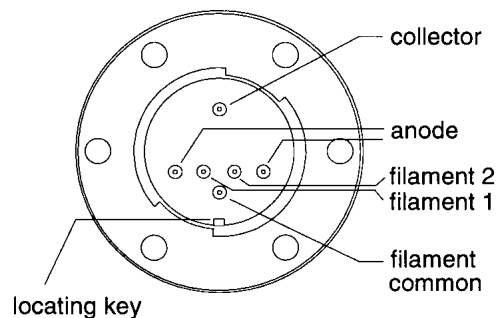

Figure 3-1 Stabil-Ion Gauge Pin and Locating Key Locations

- Avoid contaminating the Stabil-Ion Gauge. Do not touch the port. Do not talk directly at an open vacuum port. Follow good vacuum practice.
- To minimize the possibility of leaks with ConFlat¹ flanges, use high strength stainless steel bolts and a new, clean OFHC copper gasket. Avoid scratching the seal surfaces. Do not use nonmetal gaskets.
- After finger tightening all bolts, continue tightening about 1/8 turn in crisscross order, e.g., 1, 4, 2, 5, 3, 6, 4, 1, 5, 2, 6, 3, 1.... until the flanges are in contact. After contact, further tighten each bolt about 1/16 turn.

Connector collar must be locked with integral pin guard on ionization gauge tube BEFORE gauge is turned on.

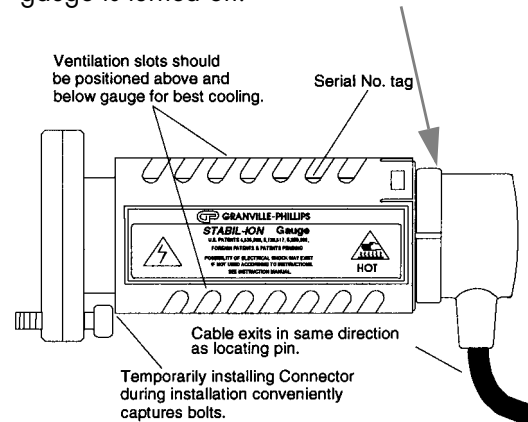

Figure 3-2 Stabil-Ion Gauge with Connector and Guard

3.3 Convecatron Gauge Installation



When high voltage is present, all exposed conductors of a vacuum must be maintained at earth ground.

Under certain conditions, dangerous high voltage can be coupled directly to an ungrounded conductor through a gas almost as effectively as through a copper wire connection. This hazard, which is not peculiar to this product, is a consequence of the ability of an electric current to flow through a gas under certain circumstances. A person may be seriously injured, or even killed by merely touching an exposed ungrounded conductor at high potential.

When high voltages are used within the vacuum system and the Convecatron Gauge envelope is not reliably grounded through its vacuum connection, either a separate ground wire must be added, or the envelope must be shielded to positively prevent human contact. The gauge envelope may be grounded by using a metal hose clamp on the gauge connected by a #12 awg copper wire to the grounded vacuum chamber.

High voltage can couple through a gas to the internal electrodes of a gauge. Do not touch the exposed pins on any gauge installed on a vacuum system where high voltage is present.

If the Convecatron option is used with the Series 370, only Series 275 Convecatron Gauge tubes manufactured in June of 1997 or later can be used on the units bearing the CE mark. Each gauge tube is marked with a date code. This date code must be F7 (June 1997) or after.

- Cleanliness pays. Keep the port cover in place until moments before installation.
- For proper operation above about 1 Torr, install Convecatron Gauges with the gauge axis horizontal. To minimize pressure indication errors, avoid installing the Convecatron Gauge where it will vibrate. Vibration causes convection cooling of the sensor and will cause the pressure indication to be high.

1. ConFlat is a registered trademark of Varian Associates

- Do not mount the gauge in a manner such that deposition of process vapors upon the internal surfaces can occur through line-of-sight access to its interior. If condensates may be present, orient the port downward to help liquids drain out.

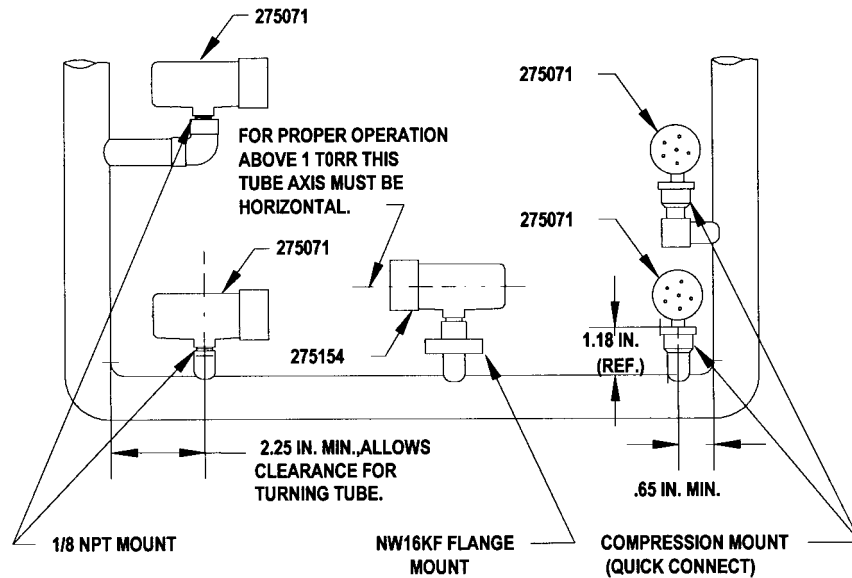

Figure 3-3 Convectron Gauge Installation

3.3.1 Compression Mount/Quick Connect

Do not use for positive pressure applications. The gauge may be forcefully ejected.

The gauge port is designed to fit a standard 1/2 in. compression/quick connect mounting such as an Ultra-Torr¹ fitting.

3.3.2 1/8 NPT Mount

Fits standard 1/8 NPT female fitting. Wrap the threads of the gauge port with TEFLON² tape and hand tighten. Do not use a wrench or tool. Tighten only sufficiently to achieve a seal.

3.3.3 VCR®/VCO® Mount

Remove the plastic or metal bead protector cap from the bead. When using gasket, place it into the female nut where applicable. Assemble components and snug finger-tight. While holding a back-up wrench stationary, tighten the female nut 1/8 turn past finger-tight for 316 stainless steel and nickel gaskets; or 1/4 turn past finger-tight for copper and aluminum gaskets.

3.3.4 NW16KF Flange Mount

The KF mounting system requires an O-ring and centering ring to be placed between the mating flanges. The flanges are then held together with the aluminum flange clamp by tightening the wing nut. Maximum pressure for this style mounting system is 1000 Torr absolute.

3.3.5 ConFlat Flange Mount

- To minimize possibility of leaks with ConFlat flanges, use high strength stainless steel bolts and a new, clean OFHC copper gasket. Avoid scratching the seal surfaces. To avoid contamination, do not use nonmetal gaskets.

1. Ultra-Torr, VCR, and VCO are registered trademarks of Cajon Co.

2. TEFLON is a registered trademark of DuPont.

2. After finger tightening all bolts, continue tightening about 1/8 turn in crisscross order, e.g., 1, 4, 2, 5, 3, 6, 4, . . . until flanges are in contact. After contact, further tighten each bolt about 1/16 turn.

3.4 Installing the Control Unit and Power Supply

1. Provide adequate ventilation for the Control Unit to dissipate 15 watts and for the Power Supply to dissipate 50 watts. ALLOW AT LEAST 1 IN. CLEARANCE AROUND THE SIDE AND TOP VENTILATION SLOTS ON THE POWER SUPPLY.
2. Do not mount the Control Unit or Power Supply above other equipment that generates excessive heat.
3. This product is designed to operate over the range 0-40 °C. Ambient temperatures above 40 °C may damage the product. For optimum electrometer calibration stability, the Control Unit ambient temperature should be 25 ±5 °C.

3.4.1 Grounding the System

1. Connect a heavy duty ground wire #12 AWG or larger from the ground lugs on the backs of the Power Supply and the Control Unit to your facility grounding electrode system. This will provide an earth ground for the Power Supply and for the Control Unit in the event either the interconnect cable or power cable are not in place. Do not connect the ground lug to the vacuum system or other component. Connect it directly to the facility grounding system such as a grounded outlet box or a grounded copper water supply pipe. Do not rely on small metal water lines to ground a component. Later on someone may replace the metal tubing with plastic tubing thus unwittingly causing a potentially dangerous situation.



Be aware that an electrical discharge through a gas may couple dangerous high voltage directly to an ungrounded conductor almost as effectively as would a copper wire connection. A person may be seriously injured or even killed by merely touching an exposed ungrounded conductor at high potential.

This hazard is not unique to this product.

2. Provide a connection to ground for other instruments with electrodes in the vacuum system possibly exposed to high voltage electrical discharges.
3. Provide a connection to ground for each ungrounded metal component in, on or around the vacuum system, including the gauge envelopes, which personnel may touch and which can potentially be exposed to high voltage electrical discharges within the vacuum system. For example, a metal bell jar resting on an organic O-ring must be connected to ground if an ionization gauge is to be used or if other high voltage sources are present in the vacuum system.



Compliance with the usual warning to connect the power cable only to a properly grounded outlet is necessary but not sufficient for safe operation of a vacuum system with this or any similar high voltage producing product. Grounding this product does not and cannot guarantee that other components of the vacuum system are all maintained at earth ground.



All conductors in, on, or around the vacuum system that are exposed to potential high voltage electrical discharges must either be shielded at all times to protect personnel or must be connected to earth ground at all times.

DIMENSIONS IN CM (IN.)

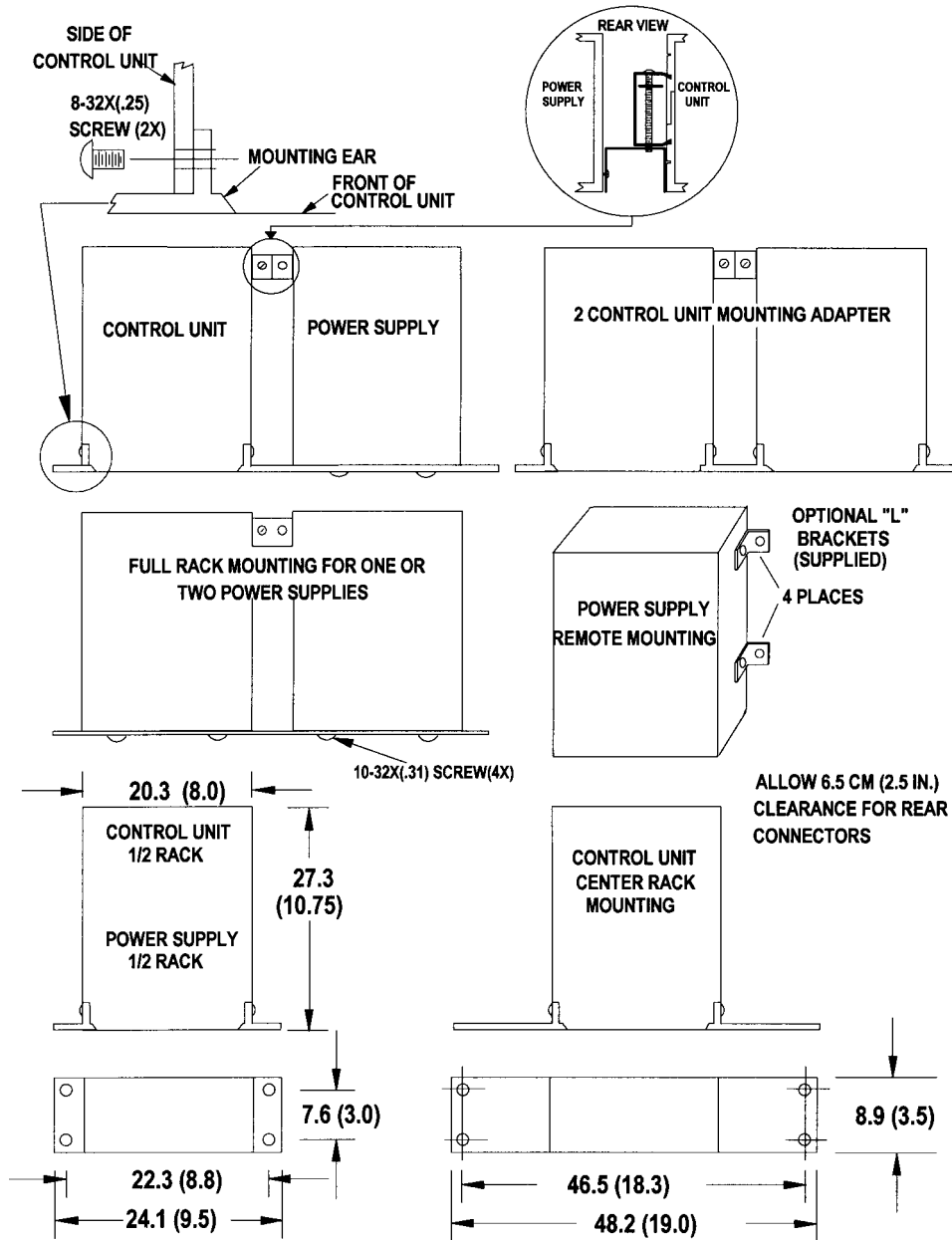

Figure 3-4 Control Unit and Power Supply Mounting

3.4.2 Installation Hardware Part Numbers

Table 3-1 Installation Hardware Part Numbers

Part Number	Adapter Hardware Description
370008	To mount one or two Power Supplies side-by-side in a 19 in. rack
370010	To mount Control Unit only on left or right side of a 19 in. rack (specify side)
370011	To mount Control Unit in center of 19 in. rack
370021	To mount two Control Units side-by-side in a 19 in. rack

3.5 Connecting Analog Outputs

3.5.1 Stabil-Ion Gauge Analog Output Signal

A signal voltage proportional to the logarithm of the Stabil-Ion Gauge pressure indication is provided on the back of the electrometer module via a standard 1/8 in. miniature phone jack. A mating connector is supplied in the hardware kit. See Section 4.6 on page 4-17 pertaining to the characteristics of this signal.

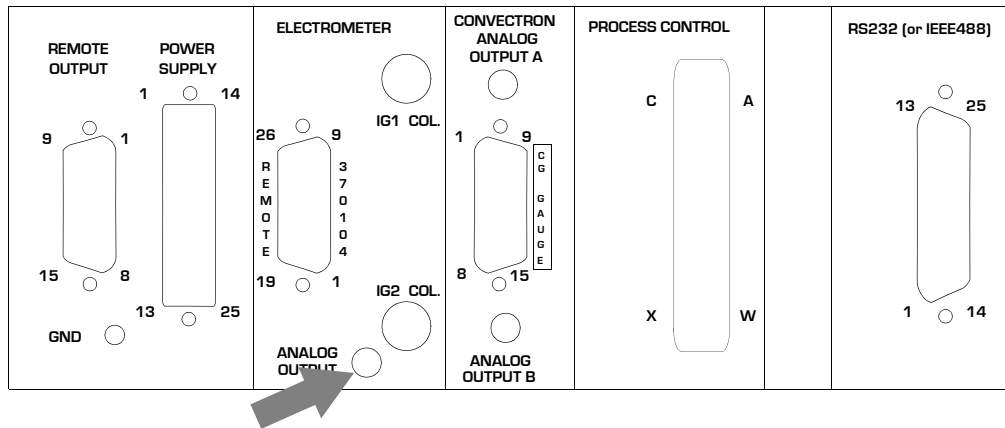

Figure 3-5 Stabil-Ion Gauge Analog Output Connector Location on Rear Panel

3.5.2 Convector Gauge Analog Output Signal

If you have Convector Gauge capability installed, signal voltages proportional to the logarithm of the Convector Gauge display indications are provided on the back of the Convector Gauge module via a standard 1/8 in. miniature phone jack. Two mating connectors are supplied with this capability. See Section 4.10 on page 4-30 pertaining to the characteristics of these signals.

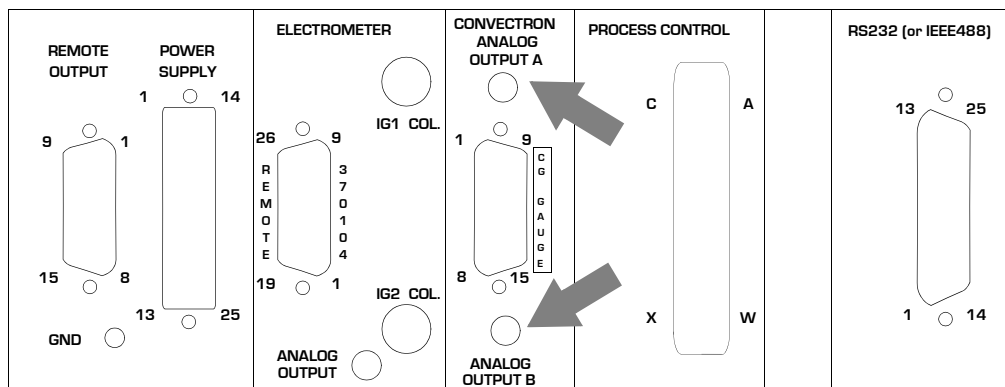

Figure 3-6 Convector Gauge Analog Output Connector Locations on the Rear Panel of the Controller

3.5.3 Convectron/Capacitance Manometer Analog Output Signal

If you have a Capacitance Manometer capability installed, signal voltages are provided on the back of the Convectron Gauge module via a standard 1/8 in. miniature phone jack - the Analog Output B port shown in Figure 3-7. Two mating connectors are supplied with this capability. See Section 4.12 on page 4-33 pertaining to the characteristics of these signals.

The analog output for the Capacitance Manometer is a dc voltage proportional to the pressure with a range of 0 to 10 volts, proportional to the transducer output. Refer to the documentation provided with your transducer for a description of this output.

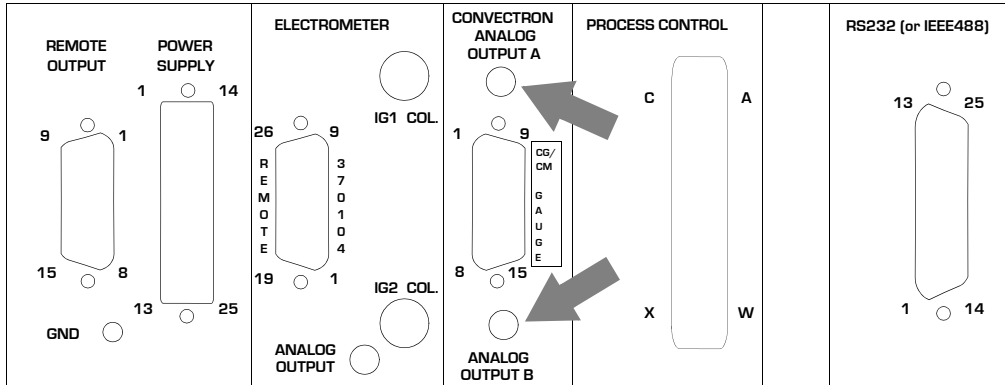

Figure 3-7 Convectron Gauge and Capacitance Manometer Analog Output Connectors on the Rear Panel of the Control Unit

3.6 Connecting Process Control Relays

Instructions for setting up this module are in Section 2.1.3 on page 2-4.

The process control connector is embossed with letters identifying each pin. Table 3-2 shows the letters designating the 3 pins assigned to each of the 6 channels.

Table 3-2 Process Control Output Connector Pin Assignments

Process Control Channel	IG		A		B	
	1	2	3	4	5	6
Common (or Pole)	W	H	M	C	J	S
Normally Closed (NC)	P	A	U	K	B	X
Normally Open (NO)	T	D	R	F	E	V
CHASSIS GND – PIN L	NO CONNECTION – PIN N					



A mating connector is supplied in the hardware kit.

Figure 3-8 Process Control Output Connector



It is the installer's responsibility to ensure that the automatic signals provided by the product are always used in a safe manner. Carefully check the system programming before switching to automatic operation.



Where an equipment malfunction could cause a hazardous situation, always provide for fail-safe operation. As an example, in an automatic backfill operation where a malfunction might cause high internal pressures, provide an appropriate pressure relief device.

- Using Figure 3-8 and circuit schematics you have prepared, make up a cable to connect the various system components which are to be controlled. Unambiguous labeling of each lead will help prevent costly mistakes.

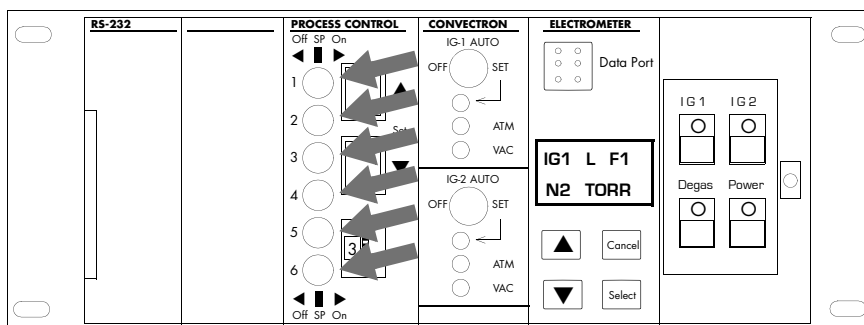

Figure 3-9 Front Panel of Control Unit (with Door Open)
Showing Locations of Override Switches

- Ensure that the Process Control channel override switches are all set to off.
- Connect the component end of the cable to the system component to be controlled.
- Plug the connector into the back of the Control Unit.
- Refer to Section 4.13 on page 4-35 for instructions for setting setpoints.

3.7 Connecting Stabil-Ion Remote Control

This factory installed option permits the following functions to be controlled from a remote location:

- Ionization gauge IG1/IG2 on/off
- Degas on/off
- Filament selection – 1 or 2 or Both
- IG gas selection – gas a or b
- CG gas selection – gas a or b
- Pressure range selection – high or low
- Ionization gauge lockout
- Front panel switch disable

In addition, the following functions are outputted in the form of relay contact closures which can signal the status of the instrument to a remote location, or control external devices.

- IG-1 on/off
- Degas on/off
- IG-2 on/off
- Circuit fault detection

The optically isolated control inputs are on a 26 pin remote input connector. The relay contact outputs are accessible on the 15 pin remote output connector.

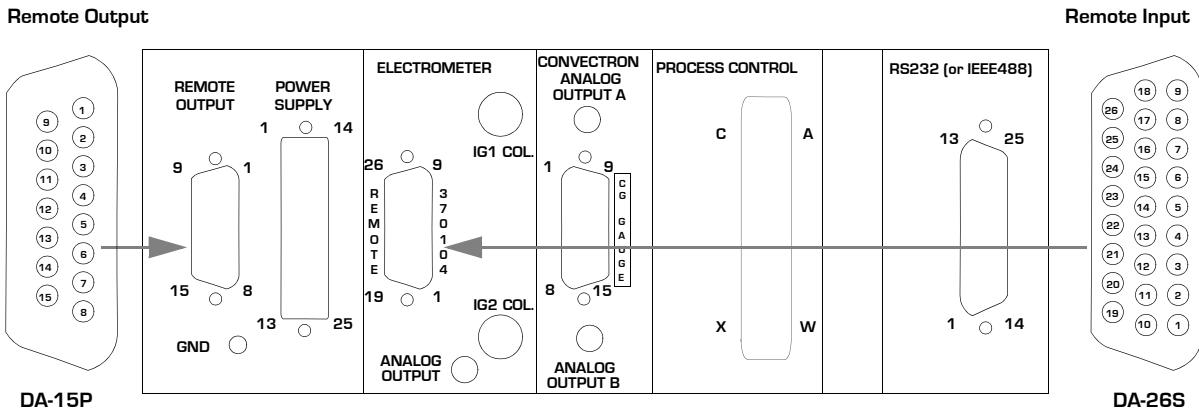

Figure 3-10 Control Unit Rear View Showing Locations of Remote Input and Output Connectors

3.7.1 Definition of Input States

“Hi” = open circuit or TTL “1” state (to maximize noise immunity, pull up to +5 volts (pin 21)).

“Low” = closed circuit selection to option common or TTL “0” state.

Maximum current = 2 mA per low input.

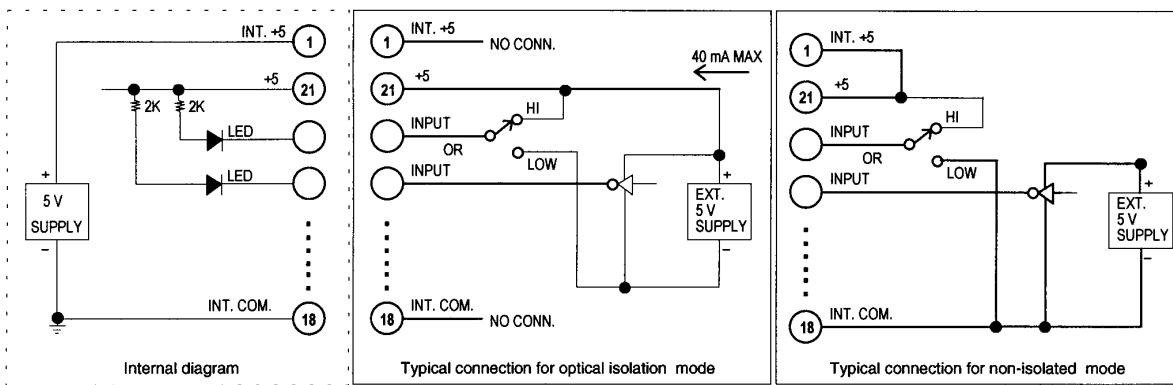

Figure 3-11 Remote Input Connections (Use DA-26P Connector, Supplied)

Table 3-3 Connections to DA-26P Connector

Pin	Function
Remote Operation Inputs	
22	IG1 On/Off
9	IG2 On/Off
8	Degas On/Off
7	IG Lockout. Turns off IG and prevents turn on from any source.
25	Keyboard Disable. Prevents IG1, IG2, and Degas buttons on front panel from functioning.
Remote Parameter Setup Inputs	
26	Remote Enable. Allows the backup filament and range selection inputs to override the switches on the electrometer module's front panel. The next 10 input functions will have no effect unless this input is held low.
6	Both Filaments IG1, selects both filaments in series.
3	Filament 2 IG1. Selects backup filament 2 operation for IG1. (If not Both)
24	Both Filaments IG2. Selects both filaments in series.
4	Filament 2 IG2. Selects backup filament 2 operation for IG2. (If not Both)
5	Pressure Range, IG1. Selects Low pressure range for IG1.
23	Pressure Range, IG2. Selects Low pressure range for IG2.
Gas Selection	
19	Gas b IG1. Selects gas b calibration table & LED when low (if data installed)
20	Gas b IG2. Selects gas b calibration table & LED when low (if data installed)
15	Gas b CGA. Selects gas b calibration table & LED when low (Argon is the default gas b)
16	Gas b CGB. Selects gas b calibration table & LED when low (Argon is the default gas b)
Power	
21	+5 V, optical isolator power: 5 V at 40 mA max.
1	Internal +5 V, access to non-isolated +5 V.
18	Internal Com., access to non-isolated ground.

3.7.2 Using the Remote Inputs

IG ON/OFF Inputs (pins 22, 9): Either IG can be turned on by the remote inputs (if the pressure in the IG is adequately low, and the IG LOCKOUT input, Pin 7, is HI) by pulling the IG input line LOW after it has been HI for at least 35 msec. The input must then remain LOW until it is desired to turn the IG off.

Either IG can be turned off through the remote input by (1) switching the input HI after it has been low for at least 35 msec., or (2) by turning the other IG on as above, or (3) by pulling the IG lockout input, Pin 7, LOW.

NOTE: The state of this input does not override other IG-on and IG-off commands from, for example, the front panel buttons, the Convectron Gauge module, or the computer interface.

Degas ON/OFF Input (pin 8): Degas can be initiated by the remote inputs (if the IG is turned on, and it is measuring less than 5×10^{-5} Torr) by pulling the DEGAS input LOW after it has been HI for at least 35 msec. The input must remain LOW for the duration of the degas.

Degas can be terminated through the remote input by (1) switching the degas input HI after it has been LOW for at least 35 msec, or (2) turning off the IG. Degas can also be terminated by allowing the programmed time to expire.

NOTE: The state of the DEGAS input does not override other degas on/off commands from, for example, the front panel button, the computer interface, or the internal timer.

IG Lockout Input (pin 7): HI allows normal IG operation. LOW forces the IGs to turn off and positively stay off.

Keyboard Disable Input (pin 25): HI allows the front panel IG control from IG1, IG2, and DEGAS buttons to function normally. LOW prevents response from these buttons, as well as the CG, and the computer interface.

Remote Enable Input (pin 26): The inputs for selecting the pressure range and the backup cathode will take precedence over the computer interface commands as well as the front panel settings on the Electrometer Module whenever this line is held LOW. When this line is open or HI, the remote parameter setup inputs will have no effect. An “_” will display in the LCD status display to indicate that the remotes are enabled.

IG1_L F1
N2 TORR

Both Filament Inputs (pins 6, 24): HI = filament 1 or 2 selected (see pins 3 and 4). LOW = both filaments operating in series (pins 3 and 4 don't affect the results).

Filament 2 Inputs (pins 3, 4): HI = filament 1 selected. LOW = backup filament 2 selected.

Pressure Range Inputs (pins 5, 23): HI = high pressure range using 100 μ A emission. LOW = low pressure range using 4 mA emission.

Gas Selection Inputs (pins 15, 16, 19, 20): HI = select gas **a** table. Low = select gas **b** tables. Separate inputs for IG1, IG2, CGA, CGB. See Section 4.3.3.4 on page 4-10 for further details.

3.7.3 Using the Remote Outputs

The relay contact outputs are accessible on the 15 pin remote output connector. These contacts provide status indication for IG1 and IG2 on or off, degas on or off, and fault detection. Figure 3-12 shows the pin designations. See Section 7.3 on page 7-4 for a description of fault relay indications.

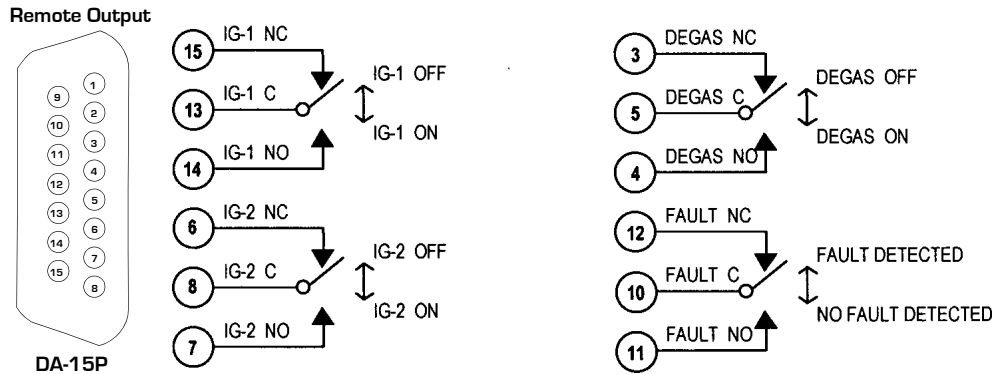

Figure 3-12 Remote Output Connector (Use DA-15S Mating Connectors, Supplied)

3.8 Connecting the RS-232 Computer Interface

Instructions for setting up this interface are in Section 2.1.4 on page 2-8.

This factory or field installed capability produces the signals shown in Table 3-4.

A mating DB-25S connector is supplied in the hardware kit. Use shielded cable to minimize electromagnetic radiation or susceptibility. Ground the shield to the metal connector shell or to Pin 1. Do not connect the shield to Pin 7.

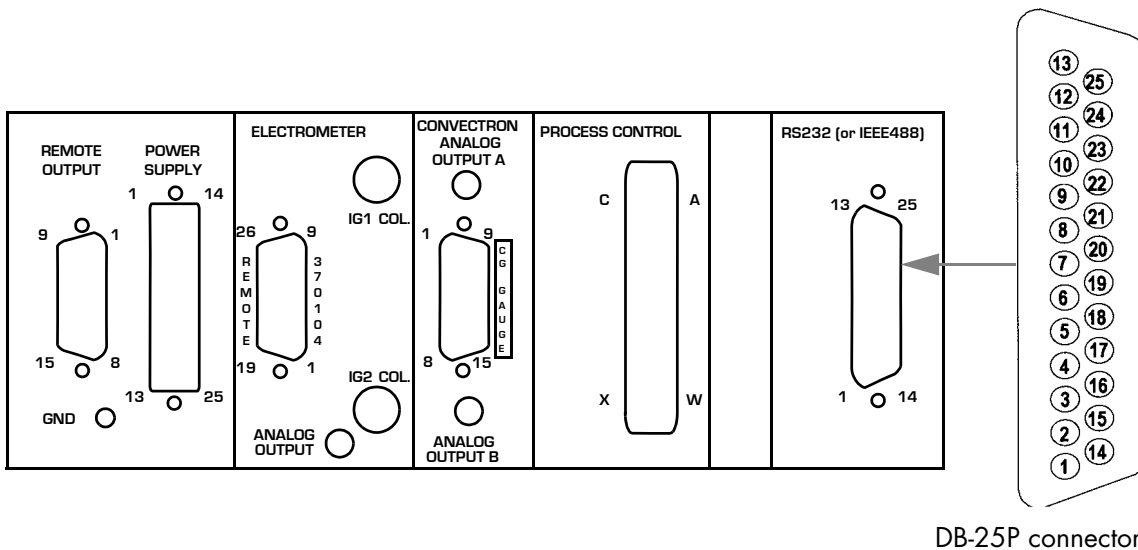

Figure 3-13 Control Unit Rear Panel Showing RS-232 Connector

Table 3-4 RS-232 Connector Pin Assignments

Signal	Pin Number	Direction
Protective Ground	1	–
Transmitted Data	2	To Computer
Received Data	3	To 370
Request to Send (RTS)	4	To Computer
Clear to Send (CTS)	5	To 370
Data Set Ready (DSR)	6	To 370
Signal Ground (common return)	7	–
Data Carrier Detect (DCD)	8	To 370
Data Terminal Ready (DTR)	20	To Computer

The DTR line is set true by 370 on power up to indicate it is on line. When 370 receives a start bit on the received data line it will input and buffer a character. The DCD line must be true at the time each character is received or that character will be ignored. 370 will continue to receive and buffer characters until the terminator (LF) is received.

Upon receiving the terminator, 370 will assert the RTS line as a holdoff, to prevent the host computer from attempting to transmit further data until the message just received has been parsed and a reply has been output.

During output of the reply, the incoming handshake lines CTS, and DSR are tested prior to beginning transmission of each character. 370 will wait until both are true before beginning transmission of a character, and will not test them again until ready to begin transmitting the next.

After transmitting the terminator, 370 will negate RTS and wait for the next incoming message.

To summarize:

CTS, DSR

Set the computer to indicate that 370 may output the next byte in its message. As shipped from the factory these lines are forced "TRUE" by the switch settings of the 370 RS-232 printed circuit board. Thus 370 will automatically assume the host is ready to receive. See Figure 2-13 on page 2-10 for the location of these switches.

DCD

Tested by 370 when a character is received. The character will be ignored unless DCD is "TRUE". As shipped from the factory, this line is forced "TRUE" by the switch settings.

DTR

Always asserted by 370. A "power on" indication.

RTS

Negated by 370 on power-up. Asserted by 370 upon receipt of a message terminator. Negated after transmitting the terminator of 370's response to that message.

RS-232 connections to a 9 pin IBM AT compatible computer can be made by using a straight-through cable. See Table 3-5.

Table 3-5 Computer Cable Pin Assignments for a 9-Pin Connector

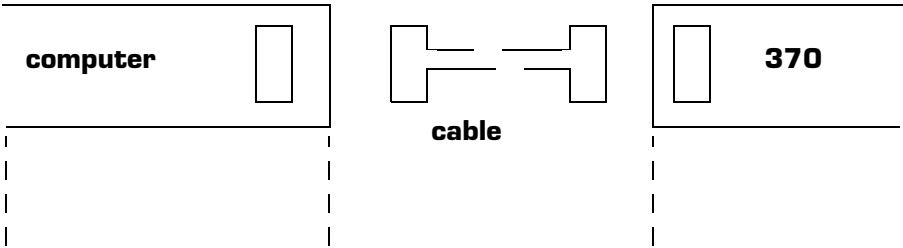

Signal	PC/AT Connector DE9P	Cable Pinout DE9S DB25S		370 Connector DB25P
RXD	2	2	2	2
TXD	3	3	3	3
Signal Ground	5	5	7	7
CTS	8	8	4	4
RTS	7	7	5	5

If the computer has a 25 pin connector, use the configuration shown in Table 3-6.

Table 3-6 Computer Cable Pin Assignments for a 25-Pin Connector

Signal	PC/AT Connector DB25P	Cable Pinout DE9S DB25S		370 Connector DB25P
RXD	3	3	2	2
TXD	2	2	3	3
Signal Ground	7	7	7	7
CTS	5	5	4	4
RTS	4	4	5	5

Section 4.14 on page 4-36 contains instructions for communicating using the RS-232 Computer Interface.

3.9 Connecting the RS-485 Computer Interface

Instructions for setting up this interface are in Section 2.1.5 on page 2-12.

The RS-485 communications option permits data output to, and gauge control by, a host computer using RS-485 digital communications. Communications handshake is by a command-response mechanism.

Information on Commands begins in Section 4.17 on page 4-37.

Connectors J1 and J2, Figure 3-14, on the rear of the control unit are wired parallel and are interchangeable. Connection can be made by daisy chaining gauge controllers together with the signal from the host computer going into one connector, then out the other connector to another gauge controller.

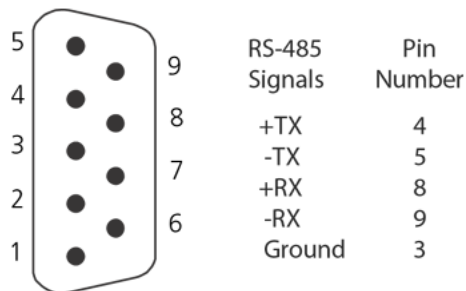

Figure 3-14 RS-485 Connector

The maximum total cable length is 4,000 ft. No more than 32 devices can be connected to one RS-485 communications line. When an RS-485 network is in an idle state, all nodes are in listen (receive) mode. Under this condition there are no active drivers on the network. In order to maintain the proper idle voltage state, bias resistors must be applied to force the data lines to the idle condition. Figure 3-15 illustrates the placement of bias resistors on a host computer, 2-wire configuration, for the typical 5 volt and 24 volt systems.

In a four wire configuration connect TX on the gauge controller to RX on the host computer and connect RX on the gauge controller to TX on the host computer. If the computer sends and receives data on 2 wires, connect the RS-485+ from the computer to both the +TX and +RX Pins (Pins 4 and 8), and connect the RS-485 from the computer to both -TX to -RX (Pins 5 and 9). Figure 3-16 shows the proper wire connections for a 2-wire connection.

When connecting multiple Series 370 Controllers connect TX to TX and RX to RX on all controllers.

The polarity may have to be reversed on the computer and other instruments—you may have to try it both ways. No damage will result if connections are wrong.

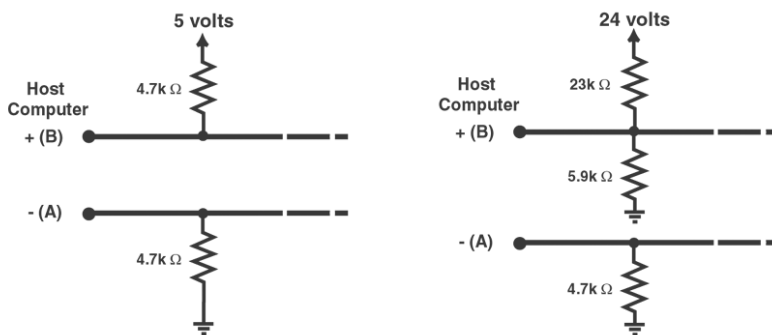

Figure 3-15 RS-485 Bias Resistor

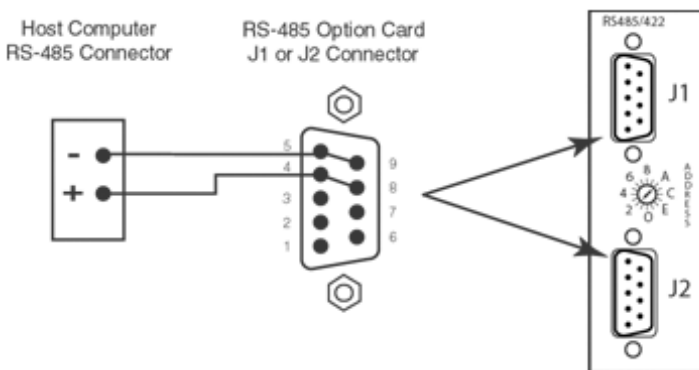

Figure 3-16 RS-485 Connectors

Table 3-7 RS-485 Specifications

Function	Specification
Communications Format	RS-485, half-duplex, asynchronous
Data Rate	9600 (Default), 4800, 2400, 1200, 600, 300, 150 baud
Character Length	8-bit or 7-bit ASCII (Factory default is 8-bit)
Parity	No parity, even or odd (Factory default is None)
Stop Bits	1 or 2 (Factory default is 1)
Handshake	None (Poll/Response)
Address	256 selectable combinations (Factory default is 01)
Number of Connections	Up to 32 devices
Total Cable Length	4,000 feet maximum
Connectors	Two 9-pin D-sub (Parallel)

3.10 Connecting the IEEE 488 Computer Interface

The IEEE 488 Computer Interface uses the industry standard 24 pin ribbon connector. (IEEE 488 Cables are available from Granville-Phillips.) Secure the mating connector from the bus using the captive screws. Instructions for setup of this interface are in Section 2.1.6 on page 2-14.

Instructions for communicating using this interface are in Section 4.16 on page 4-37.

3.11 Connecting the Gauge Cables



Be aware that an electrical discharge through a gas may couple dangerous high voltage directly to an ungrounded conductor almost as effectively as would a copper wire connection. A person may be seriously injured or even killed by merely touching an exposed ungrounded conductor at high potential.

This hazard is not unique to this product.



Be aware that when high voltage is present in any vacuum system, a life threatening electrical shock hazard may exist unless all exposed conductors are maintained at earth ground.

This hazard is not peculiar to this product.



All conductors in, on, or around the vacuum system that are exposed to potential high voltage electrical discharges must either be shielded at all times to protect personnel or must be connected to earth ground at all times.



Never touch the connector pins on any vacuum gauge if high voltages are present in the vacuum system. An electrical discharge or plasma may couple high voltage to the pins.

3.11.1 Convector Gauge Cable Installation

If you have Convector Gauge capability, connect a Convector Gauge cable between the Control Unit and each gauge.

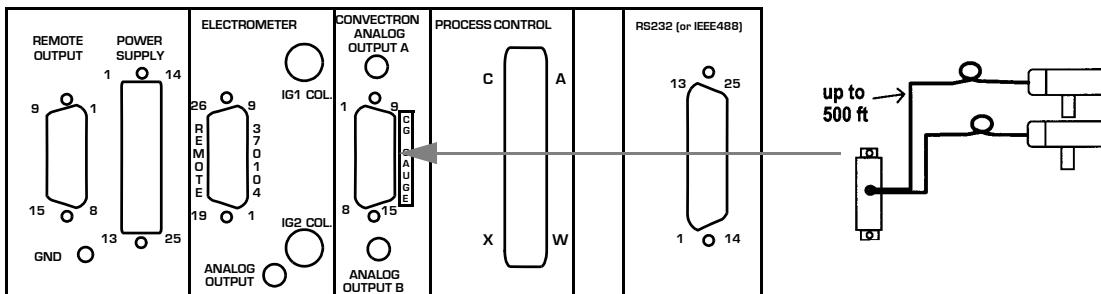



Figure 3-17 Control Unit Rear Panel Showing the Cable Connection to the Convector Gauges



Warning – If used improperly, Convector Gauges can supply misleading pressure indications that can result in dangerous overpressure conditions within the system. For use with gases other than air or N₂, consult the gas type correction charts in Section 4.7.1 on page 4-19, or use a Memory Module programmed with data for the specific gas being used.

3.11.2 Capacitance Manometer Cable Installation

The cable supplied with the 370 Vacuum Gauge Controller connects to both a Convectron gauge and a capacitance manometer. Since electrical connectors to capacitance manometers are not standardized, the cable provided is terminated with tinned wire leads. Figure 3-18 shows the color-coded functions of the wires. Consult the manual for your capacitance manometer transducer for information on electrical connection and installation of the transducer in your vacuum system.

The 370 Vacuum Gauge Controller will display pressures from capacitance manometer transducers with 0 to 10 Vdc outputs and provide power to transducers requiring ± 15 Vdc inputs. The 370 Controller can also be used as a readout device for capacitance manometers which require 115 Vdc power input, such as the MKS 220B. To wire the 370 to such a transducer, connect the white (+ signal), and brown (signal ground) wires to the manometer as directed in the transducer instruction manual. Insulate the remaining red (+15 V), black (power ground) and blue (-15 V) wires at the manometer end of the 370 cable. Connect the transducer to a 115 Vac power source as directed in your capacitance manometer instruction manual.

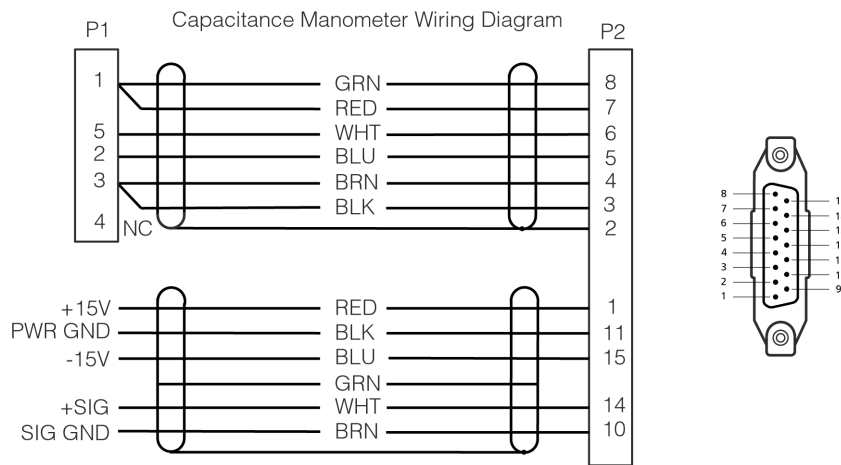

Figure 3-18 Capacitance Manometer Cable Connections

3.11.3 Stabil-Ion Gauge Cable Installation

Connect the Stabil-Ion cable(s) to the Power Supply first before connecting them to either the gauges or the Control Unit.

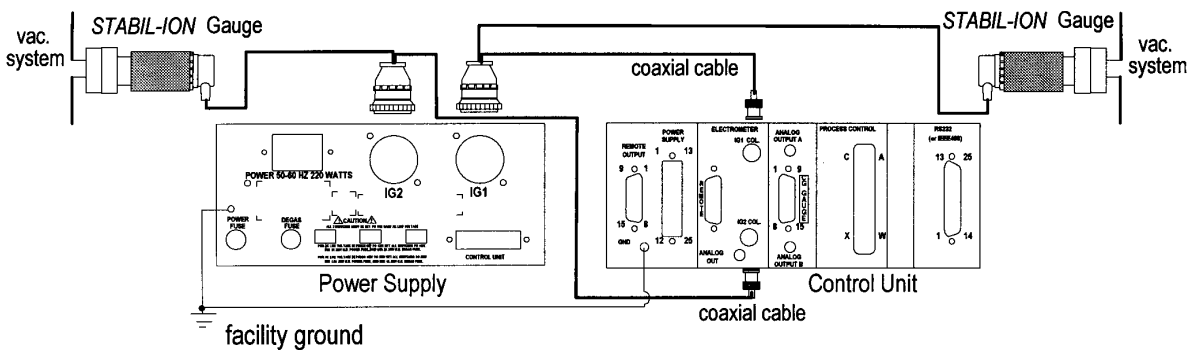

Figure 3-19 Power Supply and Control Unit Rear Views Showing the Cable Connections to the Stabil-Ion Gauges

Then connect the coaxial cable(s) to the corresponding connector on the Control Unit: IG1 to IG1, IG2 to IG2.

Next, connect the Stabil-Ion Gauge cable(s) to the Stabil-Ion Gauge(s) as follows:

- a. Line up the locating notch on the connector locking ring with the matching ridge on the blue connector shell. See Figure 3-20 on page 3-20.
- b. Line up the cable connector with the gauge pin guard. The cable will exit in line with the locating key.
- c. Insert the cable connector into the pin guard of the Stabil-Ion Gauge.
- d. Rotate slightly until the locating key engages the cable connector keyway.
- e. Push on the connector. Make sure the connector fully seats and the locking ring ears engage the pin guard ears.
- f. Rotate the blue Guard clockwise until it stops against the detent. The cable is now locked to the Stabil-Ion Gauge.

The Guard is designed to shield gauge surfaces that can rise to above 100 °C. If the Guard must be removed, be sure that the gauge is not located where personnel performing necessary system operations might come in contact with the gauge envelope. The connector and cable assembly must be removed for system baking above 150 °C.

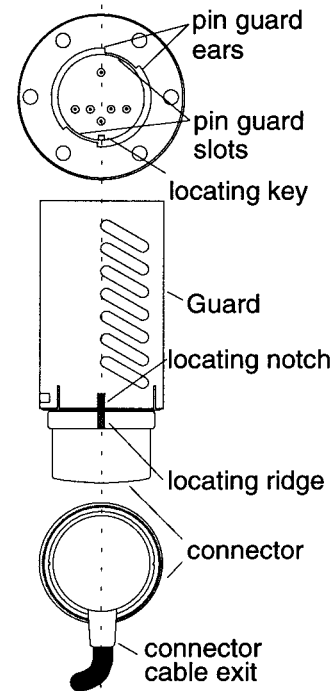

Figure 3-20 Stabil-Ion Gauge connector orientation (prior to installation)

If space does not permit leaving the blue Guard attached to the cable connection during installation, separate the Guard from the cable connector, and install as follows:

- Grasp the Guard with your fingers.
- Place your thumb on the blue connector between two of the tabs on the connector end of the Guard.
- Carefully insert a small flat screwdriver blade under the tab and gently pry outward on one tab and then the other while forcing the blue connector sideways.
- The connector will pop out of the Guard. Use care not to permanently deform the tabs.
- Place the Guard on the Gauge.
- Complete steps 5-a through 5-f (rotate the connector instead of the Guard in step “f”).
- Push the Guard back on the connector.



Do not touch the Stabil-Ion Gauge during degas operation if the Guard has been removed. Serious burns can occur.

To remove the connector from the Stabil-Ion Gauge, rotate the blue Guard counterclockwise about 20° until it hits the stop. Pull the connector straight back from the gauge.

Clamp the gauge cables in a fixed position throughout their length to provide strain relief at the connectors and to prevent undesirable effects on performance that might be caused by cable movement.



Danger, high voltage – 180V is present in the Power Supply, on the cable, and at the ion gauge when the gauge is turned on. Voltages as high as 850V peak are present during degas.

Do not operate in an explosive atmosphere.

Do not operate the product in the presence of flammable gases or fumes.

Operation of any electrical instrument in such an environment constitutes a definite safety hazard.



Do not use the product to measure the pressure of explosive or combustible gases or gas mixtures. Ionization gauge cathodes operate at high temperatures. The sensor wire of the Convector Gauges normally operates at only 125°C, but it is possible that Control Unit malfunction can raise the sensor temperature above the ignition temperature of combustible mixtures.

Danger of explosion or inadvertent venting to atmosphere exists on all vacuum systems which incorporate gas sources or involve processes capable of pressurizing the system above safe limits.



Operation of the product with line voltage other than that selected by the proper power supply switches can cause damage to the instrument and injury to personnel.

3.12 Connecting the Power Cables

1. After completing the set up, connect the interconnect cable to the Control Unit and to the Power Supply. A 0.6 m (2 ft) [or a 3 m (10 ft) for remote mounting] interconnect cable is supplied with your Controller and has identical 25 pin connectors at both ends. Secure the ends at the Power Supply connector and the Control Unit connector using the two captive screws on each connector.

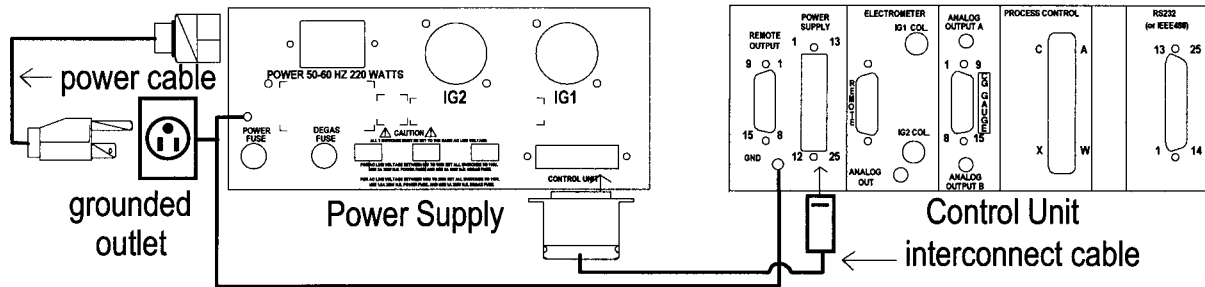

Figure 3-21 Power Supply and Control Unit Rear Views Showing Power Cable Connections



Compliance with the usual warning to connect the power cable only to a properly grounded outlet is necessary but not sufficient for safe operation of a vacuum system with this or any similar high voltage producing product. Grounding this product does not and cannot guarantee that other components of the vacuum system are all maintained at earth ground.



It is the installer's responsibility to ensure that the automatic signals provided by the product are always used in a safe manner. Carefully check the system using manual operation and the setpoint programming before switching to automatic operation.



Where an equipment malfunction could cause a hazardous situation, always provide for fail-safe operation. As an example, in an automatic backfill operation where a malfunction might cause high internal pressures, provide an appropriate pressure relief device.



Installation and wiring must be in compliance with your local building and electrical codes. CONNECT THE POWER CORD ONLY TO A PROPERLY GROUNDED OUTLET.



Primary Mains disconnect is provided by the A.C. Power Cord. Install unit so there is access to the A.C. Power Cord.

2. If you have not already done so, verify that the line voltage switches are set properly. See Section 2.2 on page 2-15.
3. Connect the power cable to a grounded outlet.
4. Assuming you have completed the set up and installation according to the foregoing instructions, the Stabil-Ion System should now be ready to turn on and operate. **If you are using the Process Control Option, you must prepare for process control operation before turning on the 370 in automatic mode.** See Section 4.13 on page 4-35. Attempting automatic operation with process control before the controls are properly set can cause costly damage and even be dangerous.

Preparing the Stabil-Ion System for Operation

4.1 Preparing for Pressure Measurement with the Stabil-Ion Gauge

The steps in this Section (4.1) assume:

- Your Stabil-Ion System has been properly set up and installed per the instructions in Chapters 2 and 3.
- The gas in your vacuum system is air or N₂. For other gases you must follow the instructions in Section 4.3.3.3 on page 4-9 for using Stabil-Ion Gauges and in Section 4.7 on page 4-18 for using Convectron Gauges.
- That you are reasonably familiar with the general theory of operation of hot cathode ionization gauges and thermal conductivity gauges.
- We recommend you consult a good text book if you are unfamiliar with vacuum technology or require more information on the general theory of operation of an ionization gauge or thermal conductivity gauge. Extremely useful information is provided in the following references.
- Dushman, S., Lafferty, J. M., *Scientific Foundations of Vacuum Technique*, John Wiley & Sons, Inc., Second Edition, New York, 1962.
- Redhead, P. A., et al., *Ultrahigh Vacuum*, Chapman and Hall, London, 1968.
- O'Hanlon, J. F., *A User's Guide to Vacuum Technology*, John Wiley & Sons, New York, 1980.

4.2 Stabil-Ion Gauge Calibration Memory

The Stabil-Ion Gauge is the first ionization gauge with sufficient long term stability to justify storing calibration data in memory. In the Series 370 Stabil-Ion System, each Gauge tube is individually calibrated and supplied with memory matched to its own calibration data. This data is stored in a Memory Module, which is supplied with the Gauge tube.

New data for each gauge is transferred to the internal memory using a Memory Module and the Data Port. The data is individually serialized to match the gauge serial number, which is printed on the gauge, the Memory Module label and is stored electronically in the memory. See Section 4.18 on page 4-41 for memory Serial No. display. If the Memory Module is not loaded for a gauge, see Section 4.3.2 on page 4-5 for loading.

If the Stabil-Ion Gauge is calibrated for a gas type other than N₂ (or air), we suggest using a label from the installation kit (Figure 1-3 on page 1-2) to indicate on the front panel the specific gas used for calibration.

Turn on the Stabil-Ion System by pressing the Control Unit Power switch. See Figure 4-1. The LED will illuminate.

Convectron Gauge equivalent N_2 pressures will be displayed whenever power is applied and the gauges and cables are installed. Make sure the IG1 AUTO and IG2 AUTO switches are in the IG AUTO ON or OFF position and have not been left in the SET positions. See Section 4.7 on page 4-18 for information on Convectron Gauge pressure measurement.

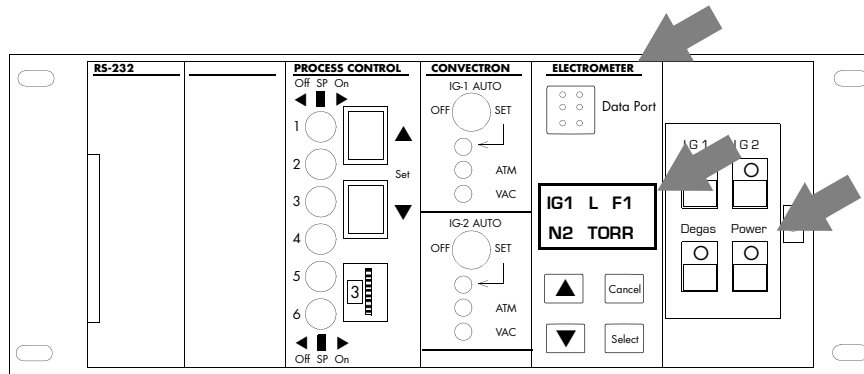

Figure 4-1 Control Unit (with Door Open) Showing Electrometer Module, Liquid Crystal Display, and Power Switch

4.3 Memory Module Loading and Operating Parameter Setup

4.3.1 Overview

- Open the front door of the Control Unit and locate the Electrometer Module and liquid crystal display (LCD). See Figure 4-1. Five status, control, setup, and information menus may be viewed on the display.
- The IG1 and IG2 Status Displays show the pressure range, filament selection, unit of measure, and gas type currently selected for the Stabil-Ion Gauges. See Figure 4-2.
- The Control and Setup menus provide an easy way to change parameters shown in the Status displays as well as scale factor, degas time, over-pressure threshold, line frequency, and display update rate.

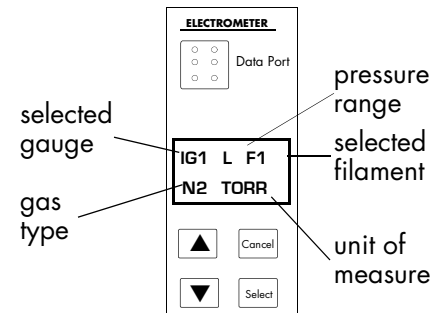

Figure 4-2 Electrometer Module with IG1 Status Menu on the Display

- The Info menu provides Calibration Memory serial numbers turn-off history and Code Version Number.
- The arrow keys, ▲ or ▼, are used to scroll through the five menus, the submenus, and to scroll through values within the submenus.
- The SELECT key is used to select the submenu item that is displayed and to store the value that is selected for the function in the display. The value in the display will flash when it is being selected but not stored. Stored parameters will be non-flashing. The arrow keys are used for selecting different values within the submenus.
- The CANCEL key is used to transfer back to the main menu item (e.g., Control Menu) and then,

with a subsequent Cancel keystroke, transfer back to the IG Status for the tube that is turned on. Also, when in a submenu with a flashing value, the Cancel key will return the display to the previously stored value.

The menus break into submenus to allow fast access to any one function. Table 4-1 gives a summary of the menu functions.

Table 4-1 Electrometer Module Display Menu Summary

IG1 STATUS	No submenus; displays summary of IG1 status	
IG2 STATUS	No submenus; displays summary of IG2 status	
CONTROL	<ol style="list-style-type: none"> 1. Pressure Range 2. Filament Selection 3. Scale Factor 4. Gas Type, IG 5. Gas Type, CG 	Default Value H Fil 1 1.000 a N2 a N2
SETUP	<ol style="list-style-type: none"> 1. Pressure Units 2. Degas Time 3. Overpressure Threshold 4. Line Frequency 5. Display Update 	Default Value Torr * 10 100% 60 Hz * FAST
INFO	<ol style="list-style-type: none"> 1. IG Calibration Memory Serial Nos. 2. CG Calibration Memory Serial Nos. 3. Turn-off History 4. Code Version No. 	

See Figure 4-3a and Figure 4-3b for a quick reference flow diagram.

*NOTE: * The Pressure Units and the Line Frequency may be different than those shown in Table 4-1, depending on the configuration you purchased.*

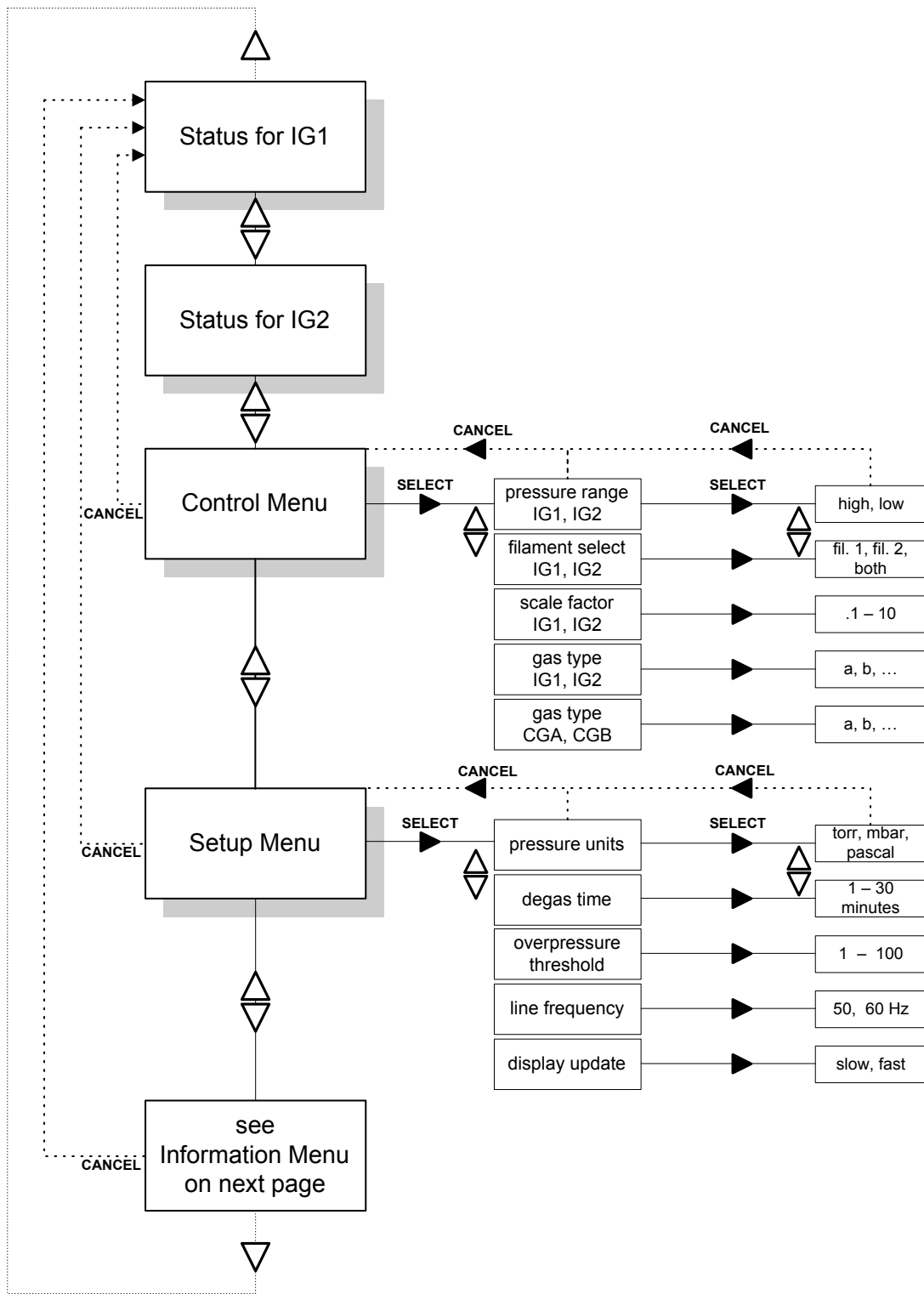

Figure 4-3a Electrometer Function Input Menus Diagram

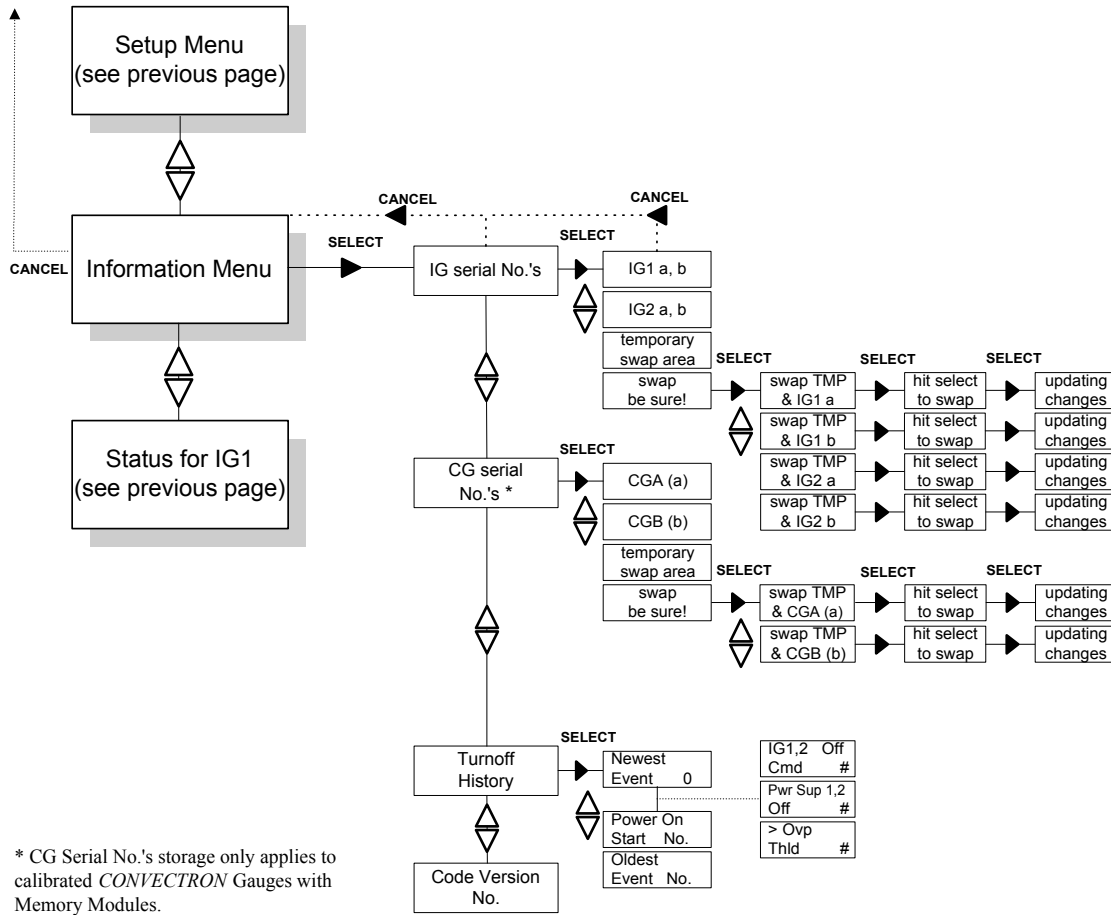

Figure 4-3b Electrometer Function Input Menus Diagram

4.3.2 Loading the Stabil-Ion Memory Module

Before the gauging system is ready to operate, the calibration data in the Memory Module needs to be loaded into the Controller and the correct gauge location selected at power up.

1. Before turning Power on, decide which Gauge/gas table location will contain data from the specific Stabil-Ion Gauge Memory Module. The default is IG1 GAS a. Verify that the Gauge is connected to that IG channel. Use Table 4-2 on page 4-6 to specify gauge location and gas type.
2. With the Controller powered off, install the Memory Module (see Figure 4-4).

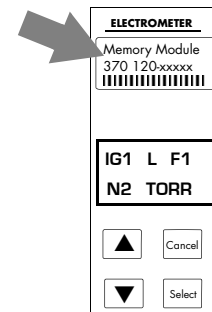

Figure 4-4 Electrometer Module with Memory Module Installed

Protect the Memory Module from static electricity. Touch a grounded, unpainted metal surface on the 370 Control Unit and then touch the surface of the anti-static bag before removing the Memory Module from its bag.

Table 4-2 Gauge Location and Gas Type Table

	Gas Type	Tube Serial No.	System Designation
IG1 (gas) a			
(gas) b			
IG2 (gas) a			
(gas) b			

- Turn on the controller power and watch the LCD display until it displays mm Load to IG1 a or mm Load to CGA a. The flashing IG1a signifies the location to which the Module data will be loaded. If you take no action for 15 sec. data from the module will automatically load into the TMP area, and the display will return to IG1 status.
- Use the ▲ or ▼ key to select alternate Gauge/gas table locations.
- When the desired gauge is selected, press the SELECT key.
- Press the SELECT key again if the Gauge selection is correct. When data is finished loading, display returns to IG1 status.
- Turn off power to the Controller and remove the Module.
- Repeat the process for other Gauges/Modules as necessary.

mm Load
to IG1a

mm Load
to IG1b

Hit SLCT
to Load!

Loading
Changes!

The serial number of the gauge, and the IG channel to which it is assigned, is displayed using the Serial # function under the INFO Menu.

The serial number of the gauge, and the IG channel to which it is assigned, is displayed using the Serial # function under the INFO Menu.

- Press the ▲ arrow key until you see the information menu.
- Press the SELECT key to see the serial number display.
- Press the SELECT key again to see the IG1 gauge serial number.
- Press ▼ repeatedly to view the successive displays (e.g. IG1 a, or IG1 b, ...). The small letter, 'a' and 'b' represent the gas type. The 00 number is the calibration revision for this serial numbered gauge.

Info
Menu

Serial
IG #'s

IG1 a 00
#####

IG1 b 00
#####

The ##### is the Serial No. of the gauge, which matches the label on the Stabil-Ion Gauge. See Figure 1-2 on page 1-1.

- When finished press CANCEL repeatedly until IG1 status appears.

4.3.3 Control Menu Variables

4.3.3.1 Pressure Range

The **H** range is preferred for applications involving pressure measurement above 1×10^{-4} Torr. The emission current and cathode power are reduced and the upper pressure limit and overpressure IG shut down setpoint are extended. The **H** range provides increased cathode life when the IG is operated at higher pressures.

The **L** range is preferred for applications involving pressure measurement below approximately 1×10^{-7} Torr. It provides the fastest response to pressures below 1×10^{-7} Torr and allows measurement to the x-ray limit of the Stabil-Ion Gauge.

Whether **H** or **L** is preferred between 10^{-4} and 10^{-7} Torr depends on whether the expected pressures will be above 10^{-4} Torr or below 10^{-7} Torr.

Table 4-3 Optimum Pressure Range Settings for N_2

Range Setting	Pressure Extreme (Torr)	Emission	Overpressure Setpoint (Torr)
H - High Range	above 10^{-4}	0.1 mA	2×10^{-2} (100%)
L - Low Range	below 10^{-7}	4 mA	8×10^{-4} (100%)

The Stabil-Ion Gauge will provide the best stability and lifetime if the pressure range selector switch is set as shown in Table 4-3.

For example, if pressures in your application will range from 1×10^{-2} to say 5×10^{-8} Torr, leave the range switch on **H**. If much of the time the system pressure will be below approximately 1×10^{-4} Torr, set the pressure range setting to **L**. We suggest you do not change the range switch frequently because there is a significant stabilization time to obtain steady state conditions.

*NOTE: When the cathode is first turned on, or has been exposed to atmospheric pressure, it is normal for a relatively large burst of gas to be released momentarily. Using the **H** range will help prevent a nuisance shutdown from this burst.*

To change the pressure range:

(The factory default setting for this function is HIGH.)

1. Press the ▼ arrow key until you see the control menu in the display.

Control
Menu

2. Press the SELECT key to see the pressure range display.

IG1 LOW
PRESS.RNG or IG1 HIGH
PRESS.RNG

3. Press the SELECT key again so that LOW, or HIGH is flashing.

IG1 **LOW**
PRESS.RNG

4. Press the ▲ or ▼ keys to choose the desired range.

IG1 **HIGH**
PRESS.RNG

5. Press the SELECT key to store the new setting in memory.

IG1 HIGH
PRESS. RNG

6. Press CANCEL to return to the control menu.
(Or press CANCEL again to return to the status display for the gauge tube that is turned on.)

Control
Menu

4.3.3.2 Filament Selection

The filament coating, which is utilized in the Stabil-Ion Gauge to provide electron emission at relatively low filament temperatures, has a finite operating life—typically two to three years at low pressure. Ion bombardment at higher pressures tends to erode the coating faster than at lower pressures. Stabil-Ion Gauges have a second independent filament for use when the first filament finally tires and does not emit sufficiently. The Controller will automatically turn the IG off if the filament has insufficient emission either due to contamination of the filament or long use. Select the other filament for continued operation.

Set at filament **1** (or filament **2** if alternate filament is required). Separate settings are provided for IG1 and IG2. The **Both** setting causes both filaments to light for use in harsh environments where there is potential for filament contamination.

The factory default setting for this function is FIL 1 (for filament 1).

1. Press the ▼ arrow key until you see the control menu in the display.

Control
Menu

2. Press the SELECT key to see the pressure range display.

IG1 LOW
PRESS. RNG

or

IG1 HIGH
PRESS. RNG

3. Press the ▲ or ▼ arrow keys to see the filament select display.

IG1 FIL B
FIL. SEL

4. Press the SELECT key so that FIL 1 (or FIL 2 or Both) is flashing.

IG1 FIL B
FIL. SEL

5. Press the ▲ or ▼ arrow keys to select the desired filament.

IG1 FIL 2
FIL. SEL

6. Press the SELECT key to store the new setting in memory.

IG1 FIL 2
FIL. SEL

7. Press CANCEL to return to the control menu.
(Or press CANCEL again to return to the status display for the gauge tube that is turned on.)

Control
Menu

4.3.3.3 Gauge Scale Factor

SCALE FACTOR: The scale factor is normally set to 1.000. This will cause the display to read correctly when the gas in the system matches the gas of the calibration memory. Scale factor adjustment is provided so that the display can be made to read approximately correct for other gasses when using the N₂ memory. See Table 4-4, Scale Factors, for other gases.

If highly accurate measurement of pressure of gases is required, we recommend calibration for the specific gas and system to be used. See Section 4.2 on page 4-1. The standard calibration is for N₂. If the calibration memory is changed to match the gas in the system, the correct scale factor setting is 1.000.

Different gases have different ionization probabilities. If a Stabil-Ion Gauge and Controller are calibrated for N₂, and if argon is the predominant gas in the system, setting the scale factor at 7.75×10^{-1} as shown in Table 4-4 causes the pressure indications for N₂ to be multiplied by 0.775, thus providing correct pressure indications for argon over most of the pressure range. At pressures above 1×10^{-5} Torr this method may not provide accurate pressure indications.

Table 4-4 Scale Factors for Use with Ionization Gauges

(Do not use these scale factors for CONVECTRON Gauges)

Gas	Scale Factor	Gas	Scale Factor
He	5.56	H ₂ O	8.93×10^{-1}
Ne	3.33	NO	8.62×10^{-1}
D ₂	2.86	Ar	7.75×10^{-1}
H ₂	2.17	CO ₂	7.04×10^{-1}
N ₂	1.00	Kr	5.15×10^{-1}
Air	1.00	SF	4.00×10^{-1}
O ₂	9.90×10^{-1}	Xe	3.48×10^{-1}
CO	9.52×10^{-1}	Hg	2.75×10^{-1}

To prepare for measuring the pressure of gases other than air or N₂ with IG1 or IG2, proceed as follows:

(The default factory setting for this function is 1.000.)

1. If a Memory Module is used for an alternate gas see Section 4.3.2 on page 4-5 for loading and leave the Scale Factor at 1.00.
2. Open the front panel door and locate the electrometer module and LCD display.
3. Press the ▼ arrow key until you see the control menu in the display.

Control
Menu

4. Press the SELECT key to see the pressure range display.
5. Press the ▲ or ▼ arrow keys until you see the scale factor display.
6. Press the SELECT key so that the scale factor value is flashing.
7. Press the ▲ or ▼ arrow keys to select the desired value.
8. Press the SELECT key to store the new setting in memory.
9. Press CANCEL to return to the control menu.
(Or press CANCEL again to return to the status display for the gauge tube that is turned on.)
10. Repeat steps for IG2. IG2 may be set for a different gas scale factor than IG1.

IG1 LOW PRESS.RNG or IG1 HIGH PRESS.RNG

IG1 SCAL
1.000

IG1 SCAL
1.000

IG1 SCAL
.775

IG1 SCAL
.775

Control
Menu

4.3.3.4 Selecting Gas Type for the Stabil-Ion Gauge

The Stabil-Ion Gauge comes with a Memory Module containing calibration data for nitrogen. These data are loaded into the Controller memory as gas “a” during the Memory Module loading procedure. See Section 4.3 on page 4-2. If a Memory Module is purchased and installed for a second gas “b”, gas selection may be done using the following process:

Note: If the Stabil-Ion Gauge calibration is for a gas type other than N₂ (or air), we suggest placing a label on the slip-in gas card display line indicating the gas type or types used for calibration to prevent mix-ups (see Figure 4-5 on page 4-11). Labels for common gases are provided as a part of the standard installation hardware. (See Figure 1-3 on page 1-2.)

The default factory setting for this function is N₂.

1. Press the ▼ arrow key until you see the control menu in the display.
2. Press the SELECT key to see the pressure range display.
3. Press the ▲ or ▼ arrow key until you see the IG gas type display.
4. Press the SELECT key so that the gas type is flashing.
5. Press the ▲ or ▼ arrow key to select GAS type. (Note: this function is only applicable when the controller contains a factory supplied second gas curve table that is not a factory default.)

Control
Menu

IG1 LOW PRESS.RNG or IG1 HIGH PRESS.RNG

IG1 GAS a
N2

IG1 GAS a
N2

IG1 GAS b
Ar

6. Press the SELECT key to store the new setting.
7. Press CANCEL to return to the control menu.
(Or press CANCEL again to return to the status display for the gauge tube that is turned on.)
8. To change the gas type label, open the door and lift the label card from its slot in the front panel. Gas type labels are included in the mounting hardware kit. See Figure 4-5.

See Section 4.3.3.3 on page 4-9 for approximate programming of alternate gas types using the scale factor.

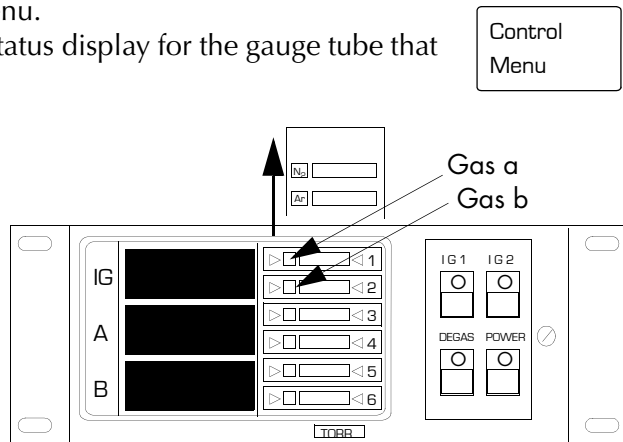



Figure 4-5 Control Unit Front Panel Showing Removal of Units of Measure Label Card

4.3.3.5 Selecting Gas Type for the Convectron Gauge

The Controller comes standard with gas a programmed for N₂ and gas b programmed for Ar. To select which gas table is used for CGA or CGB use the key sequence described below. Gas selection is also available using the computer interfaces (see Section 4.17 on page 4-37) and using the Remote Input (see Section 3.7.1 on page 3-10).



Warning – If used improperly, Convectron Gauges can supply misleading pressure indications that can result in dangerous overpressure conditions within the system. For use with gases other than air or N₂, consult the gas type correction charts in Section 4.7.1 on page 4-19, or use a Memory Module programmed with data for the specific gas being used.

The default factory setting for this function is GAS a or N₂.

1. Press the ▼ arrow key until you see the control menu in the display.
2. Press the SELECT key to see the pressure range display.
3. Press the ▲ or ▼ arrow key until you see the CG gas type display.
4. Press the SELECT key so that the gas type is flashing.
5. Press the ▲ or ▼ arrow key to select GAS type.

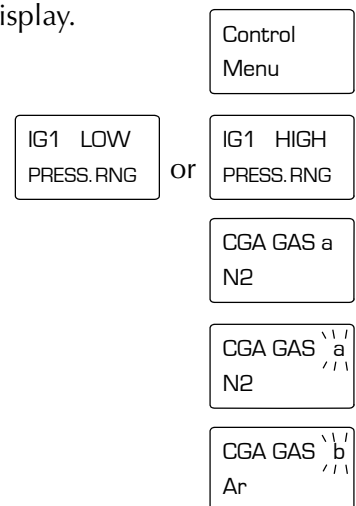

6. Press the SELECT key to store the new setting.

CGA GAS b
Ar

7. Press CANCEL to return to the control menu.
(Or press CANCEL again to return to the status display for the gauge tube that is turned on.)

Control
Menu

8. To change the gas type label, open the door and lift the label card from its slot in the front panel. Gas type labels are included in the mounting hardware kit (see Figure 4-5 on page 4-11).

4.3.4 Setup Menu Variables

4.3.4.1 Units of Measure

The default factory setting for this function is TORR.

1. Press the ▼ arrow key until you see the setup menu.

Setup
Menu

2. Press the SELECT key to see the units display.

UNITS
TORR

3. Press the SELECT key again so that the unit TORR (or PASCAL, or mBAR) is flashing.

UNITS
TORR

4. Press the ▲ or ▼ arrow keys to select the desired units.

UNITS
PASCAL

5. Press the SELECT key to store the new setting in memory.

UNITS
PASCAL

6. Press CANCEL to return to the setup menu.
(Or press CANCEL again to return to the status display for the gauge tube that is turned on.)

Setup
Menu

NOTE: This function changes units for the electrometer module only. The Convectron units need to be changed separately

4.3.4.2 Selecting Degas Time

The default factory setting for this function is 10 min.

1. Press the ▼ arrow key until you see the setup menu.

Setup
Menu

2. Press the SELECT key to see the units display.

UNITS
TORR

3. Press the ▼ key until you see the degas time display.

DEGAS
TIME 10

4. Press the SELECT key so that the time (in minutes) is flashing.
5. Press the ▲ or ▼ arrow keys to select the desired degas time (1 – 30 minutes).
6. Press the SELECT key to store the new setting in memory.
7. Press CANCEL to return to the setup menu.
(Or press CANCEL again to return to the status display for the gauge tube that is turned on.)

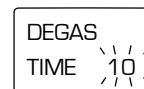
 A rectangular display box showing "DEGAS" on the top line and "TIME 10" on the bottom line. The number "10" is surrounded by a dashed border, indicating it is flashing.

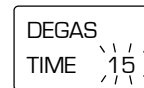
 A rectangular display box showing "DEGAS" on the top line and "TIME 15" on the bottom line. The number "15" is surrounded by a dashed border, indicating it is flashing.

 A rectangular display box showing "DEGAS" on the top line and "TIME 15" on the bottom line. The number "15" is solid.

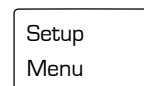
 A rectangular display box showing "Setup" on the top line and "Menu" on the bottom line.

4.3.4.3 Overpressure Threshold

This control is factory set so the ion gauge will shut down when the pressure rises above the overpressure setpoint pressures shown in Table 4-3 on page 4-7. The pressure in Table 4-3 corresponds to 100% of the overpressure threshold, and cannot be increased beyond this point. Selecting a lower percent value will cause the ion gauge to turn off at a lower pressure (e.g. 10% is one decade lower in pressure.) This adjustment affects both pressure ranges and both IG's simultaneously.

The default factory setting for this function is 100%.

See Table 4-3 on page 4-7 for factory shutoff pressures and Section 7.10 on page 7-9 for a more detailed discussion of shutdown pressure limits.

1. Press the ▼ arrow key until you see the setup menu.
2. Press the SELECT key to see the units display.
3. Press the ▼ key until you see the overpressure threshold display.
4. Press the SELECT key again so that the overpressure percent is flashing.
5. Press the ▲ or ▼ arrow keys to select the desired overpressure threshold percentage.
6. Press the SELECT key to store the new setting in memory.
7. Press CANCEL to return to the setup menu.
(Or press CANCEL again to return to the status display for the gauge tube that is turned on.)

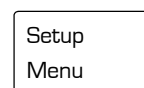

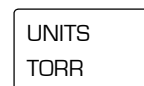
 A rectangular display box showing "Setup" on the top line and "Menu" on the bottom line.

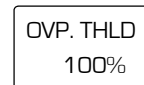

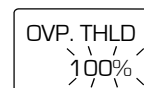
 A rectangular display box showing "UNITS" on the top line and "TORR" on the bottom line.

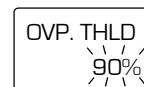
 A rectangular display box showing "OVP. THLD" on the top line and "100%" on the bottom line.

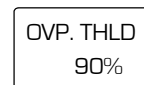
 A rectangular display box showing "OVP. THLD" on the top line and "100%" on the bottom line. The number "100%" is surrounded by a dashed border, indicating it is flashing.

 A rectangular display box showing "OVP. THLD" on the top line and "90%" on the bottom line. The number "90%" is surrounded by a dashed border, indicating it is flashing.

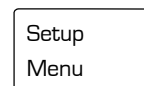
 A rectangular display box showing "OVP. THLD" on the top line and "90%" on the bottom line. The number "90%" is solid.

 A rectangular display box showing "Setup" on the top line and "Menu" on the bottom line.

4.3.4.4 Line Frequency

Best noise rejection is achieved when the internal filters are set for the proper a.c. line frequency being used.

The default factory setting for this function is 60 Hz.

1. Press the ▼ arrow key until you see the setup menu.
2. Press the SELECT key to see the units display.
3. Press the ▼ key until you see the line frequency display.
4. Press the SELECT key again so that the frequency value is flashing.
5. Press the ▲ or ▼ arrow keys to select the desired line frequency.
6. Press the SELECT key to store the new setting in memory.
7. Press CANCEL to return to the setup menu.
(Or press CANCEL again to return to the status display for the gauge tube that is turned on.)

Setup
Menu

UNITS
TORR

LINE. FQ
60 Hz

LINE. FQ
60 Hz

LINE. FQ
50 Hz

LINE. FQ
50 Hz

Setup
Menu

4.3.4.5 Pressure Display Update Speed

It is sometimes desirable to slow down the display update rate. This feature causes the display to indicate pressure data that has been averaged over a 3 second period.

The default factory setting for this function is FAST.

1. Press the ▼ arrow key until you see the setup menu.
2. Press the SELECT key to see the units display.
3. Press the ▼ key until you see the update DISPLAY UPD. SLOW update will update the display every 3 sec. FAST update will update the display every 0.5 sec.
4. Press the SELECT key again so that the update speed is flashing.
5. Press the ▲ or ▼ arrow keys to select the desired update speed.

Setup
Menu

UNITS
TORR

DISPLAY
UPD FAST

DISPLAY
UPD FAST

DISPLAY
UPD SLOW

6. Press the SELECT key to store the new setting in memory.

DISPLAY
UPD SLOW

7. Press CANCEL to return to the setup menu.
(Or press CANCEL again to return to the status display for the gauge tube that is turned on.)

Setup
Menu

4.4 Stabil-Ion Gauge Turn On

- After turning on the Stabil-Ion Controller make sure a Memory Module is loaded for each Stabil-Ion Gauge. See See Loading the Stabil-Ion Memory Module on page 4-5 for further information.
- When the pressure in the vicinity of IG1 is less than the overpressure setpoint listed in Table 4-3 on page 4-7, as indicated by a Convectron Gauge or another gauge, turn on IG1. See Section 4.8 on page 4-28 for automatic operation.
- The N₂ equivalent pressure within IG1 will be displayed in the pressure units you have specified (Torr, mbar or Pa). See Section 4.3.4.1 on page 4-12 to change pressure units.
- The above two steps also apply for IG2 if your Stabil-Ion System is equipped with the Dual Stabil-Ion Operation module.

4.4.1 Alternate ON/OFF Gauge Control

The Stabil-Ion Gauges may be turned on and off in 4 ways:

1. Using the front panel push buttons, IG1 and IG2.
2. Remotely with the available Remote Control module (see Section 3.7 on page 3-9).
3. Automatically using the auto on function of the Convectron Gauge module (see Section 4.8 on page 4-28).
4. Using the RS-232, RS-485, or IEEE 488 Computer Interface modules (see Section 4.17 on page 4-37).

In addition, the Stabil-Ion Gauge will be automatically turned off by excessive pressure, filament over current condition or out of range grid voltage. For information on the cause of unexpected gauge turn off see Section 7.11 on page 7-10.

4.5 Degassing the Stabil-Ion Gauge





Danger, high voltage - 180V is present in the Power Supply, on the cable, and at the ion gauge when the gauge is turned on. Voltages as high as 850V peak are present during degas.





Be aware that an electrical discharge through a gas may couple dangerous high voltage directly to an ungrounded conductor almost as effectively as would a copper wire connection. A person may be seriously injured or even killed by merely touching an exposed ungrounded conductor at high potential.

This hazard is not unique to this product.

- 

Be aware that when high voltage is present in any vacuum system, a life threatening electrical shock hazard may exist unless all exposed conductors are maintained at earth ground.
This hazard is not peculiar to this product.
- 

All conductors in, on, or around the vacuum system that are exposed to potential high voltage electrical discharges must either be shielded at all times to protect personnel or must be connected to earth ground at all times.
- 

Compliance with the usual warning to connect the power cable only to a properly grounded outlet is necessary but not sufficient for safe operation of a vacuum system with this or any similar high voltage producing product. Grounding this product does not and cannot guarantee that other components of the vacuum system are all maintained at earth ground.
- 

Finite Lifetime - After ten years of normal use or even non-use, the electrical insulation in this product may become less effective at preventing electrical shock. Under certain environmental conditions which are beyond the manufacturer's control, some insulation material may deteriorate sooner. Therefore, periodically inspect all electrical insulation for cracks, crazing, or other signs of deterioration. Do not use if the electrical insulation has become unsafe.
- 

Do not touch the Stabil-Ion Gauge during degas operation if the Guard has been removed. Serious burns can occur.

The 370 Stabil-Ion System employs electron bombardment (EB) degassing of gauge electrodes, which is the most direct and efficient means to remove contaminants. High energy electrons striking the anode heat the anode and help remove any foreign materials while the increased filament power cleans the filament surface effectively. Of course, it is necessary to pump the contaminants from the gauge during degas. A system pressure below 10^{-5} Torr is required to accomplish this effectively. Measurements below about 10^{-8} Torr require degassing in the 10^{-6} Torr range and again as the system approaches the ultimate pressure.

Degas cannot be activated unless the Stabil-Ion Gauge pressure indication is below 5×10^{-5} Torr (6.6×10^{-5} mbar, or 6.6×10^{-3} Pa). Degassing above this pressure is of little value and may cause pressure bursts that can cause an electrical gas discharge which can couple high voltage to the vacuum system hardware, shut down the Stabil-Ion Gauge, and in some cases cause damage—or create a shock hazard unless the system is properly grounded.

Degas power may be turned on or off in four ways:

- Using the front panel Degas push-button.
- Via the Remote Control input. See Section 3.7 on page 3-9.
- Using an RS-232, RS-485, or IEEE 488 Computer Interface module. See Section 4.16 on page 4-37.
- From the internal Degas timer (time-out).

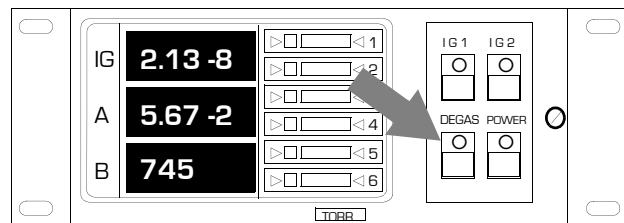

Figure 4-6 Control Unit Front Panel Showing Degas Button

4.5.1 Pressure Indication During Degas

An approximate indication of pressure within the Stabil-Ion Gauge is provided on the digital display during degas. Observing this pressure indication rise, peak out and then fall is an excellent means of determining the optimum time of degas. The indication may eventually be unrealistically low due to a reverse x-ray current effect or temporary gauge pumping. Degassing purposely changes surface conditions in the gauge. After degassing, permit sufficient time for steady state conditions to be established before attempting to make measurements.

4.5.2 Degas Power Limiter

For convenience and improved safety, degas power is automatically reduced as gas is liberated to prevent excessive pressure rise and help reduce the possibility of a gas discharge forming. As the electrodes clean up, power is increased to a maximum of 40 W. This feature limits the maximum pressure indication to about 5×10^{-5} Torr during degas.

4.5.3 Gauge Bakeout

Applying an external heat source to the vacuum system and to the gauge envelope can speed the removal of contamination from the interior surfaces. Bakeout temperatures between 150 °C and 300 °C are typically adequate. Do not exceed 450 °C at the Stabil-Ion Gauge envelope. Do not exceed 150 °C at the cable and connector.

4.6 Stabil-Ion Gauge Analog Output Signal

A signal voltage proportional to the logarithm of the Stabil-Ion Gauge pressure indication is provided on the back of the electrometer module via a standard 1/8 in. miniature phone jack.

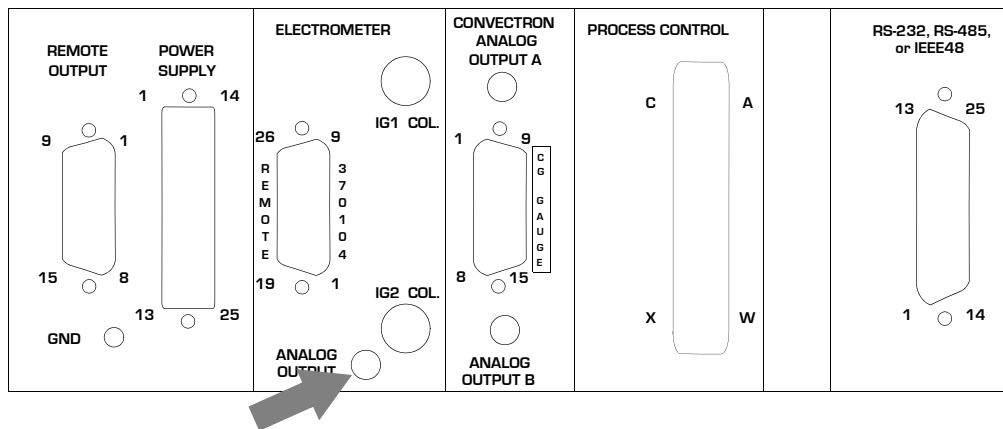

Figure 4-7 Control Unit Rear Panel Showing Location of IG Analog Output

Normal Measurement Operation

$$\begin{aligned} \text{Pressure indication, } P_i &= 10^{V-11} \text{ Torr or mbar} \\ &= 10^{V-9} \text{ Pascal} \end{aligned}$$

When gauge is off, V is = 11 volts

This signal voltage is determined by the pressure indicated on the IG display. Thus if the scale-factor is set correctly for a given gas as specified in Section 4.3.3.3 on page 4-9, the equations above and curves in Figure 4-8 on page 4-18 still apply for the given gas.

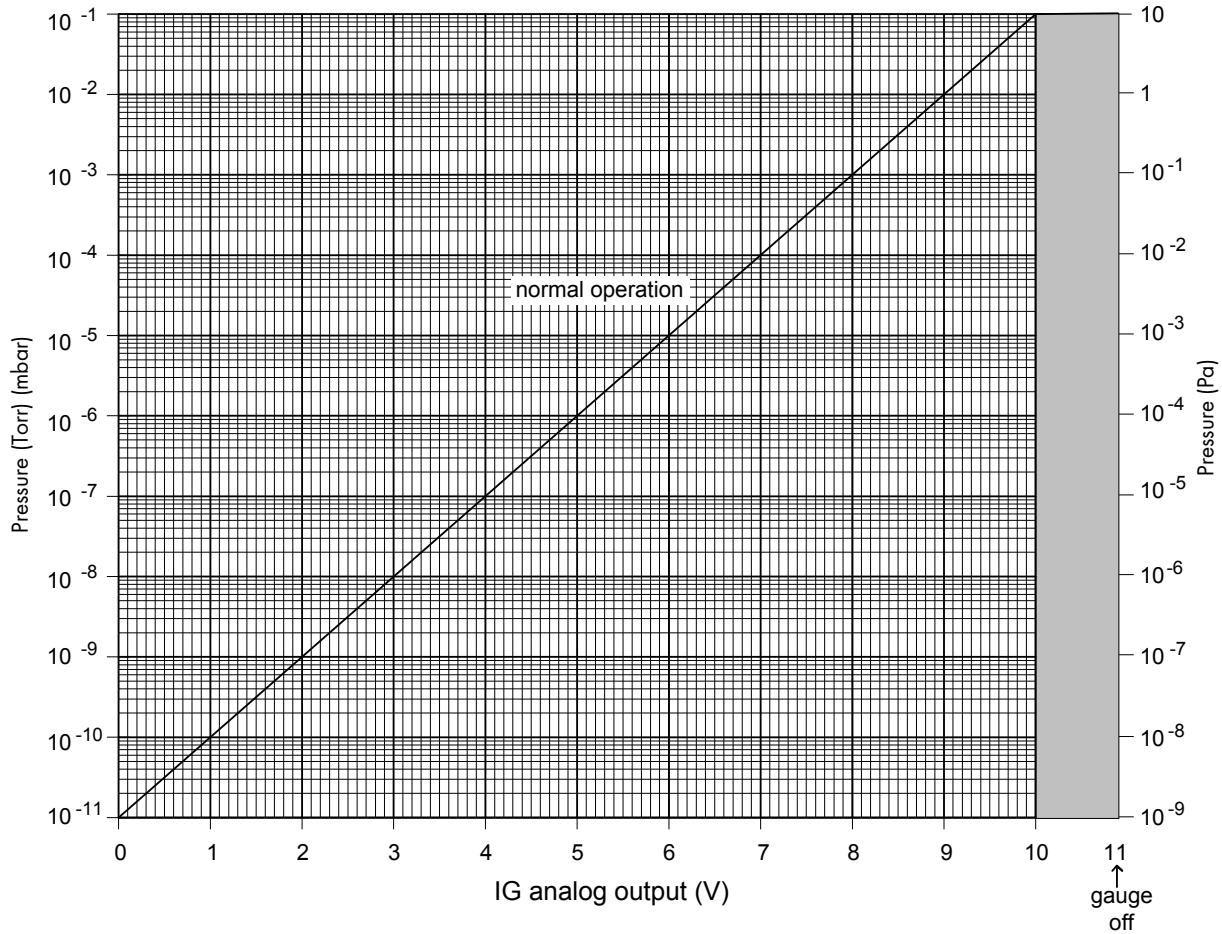



Figure 4-8 Ionization Gauge Analog Output vs. Pressure

4.7 Preparing for Convectron Gauge Operation

Convectron Gauge pressures are indicated on lines A and B of the 370 Controller display.



Using the N₂ calibration to pressurize a vacuum system above about 1 Torr with certain other gases can cause dangerously high pressures which may cause explosion of the system. See Section 4.7.1 on page 4-19 before using with other gases.

Install suitable devices that will limit the pressure to the level that the vacuum system can safely withstand. In addition, install suitable pressure relief valves or rupture disks that will release pressure at a level considerably below that pressure which the system can safely withstand.

Suppliers of pressure relief valves and pressure relief disks are listed in the Thomas Register under “Valves, Relief”, and “Discs, Rupture”.

Confirm that these safety devices are properly installed before installing the product. In addition, check that (1) the proper gas cylinders are installed, (2) gas cylinder valve positions are correct on manual systems, and (3) the automation is correct on automated systems.

Vacuum gauges with compression fittings may be forcefully ejected if the vacuum system is pressurized.

4.7.1 Understanding Convector Gauge Pressure Measurement in Gases other than Nitrogen (or Air)

Convector Gauges are thermal conductivity gauges of the Pirani type. These gauges transduce gas pressure by measuring the heat loss from a heated sensor wire maintained at constant temperature. For different gases, the heat loss is different at any given true pressure and thus the pressure indication can be very different.

It is important to understand that the indicated pressure of a Convector Gauge depends on the type of gas, the orientation of the gauge axis, and on the gas density in the gauge. Convector Gauges are normally supplied calibrated for N₂ (air has approximately the same calibration). With proper precautions, the Convector Gauge may be used to measure pressure of certain other gases.

The following information in this section applies only when the Convector Gauge has been calibrated for N₂, either with the standard factory memory data or for a specific gauge using a Memory Module and when the Convector Gauge is mounted with its axis horizontal. It does not apply when a Convector Gauge's memory has been reprogrammed for a specific gas other than N₂.

At pressures below a few Torr, there is no danger in measuring pressure of gases other than N₂ and air, merely inaccurate indications. A danger arises if the N₂ calibration is used without correction to measure higher pressures of some other gases. For example, N₂ or air at 24 Torr causes the same heat loss from the Convector sensor as will argon at atmospheric pressure. Thus if the pressure indication of the Convector Gauge is not properly corrected for argon, an operator attempting to fill a vacuum system with 1/2 atmosphere of argon would observe an indication of only 12 Torr when the actual pressure had risen to the desired 380 Torr. Continuing to fill the system with argon to 760 Torr would result in only a 24 Torr indication. Depending on the pressure of the argon gas source, the chamber could be dangerously pressurized while the display continued to read about 30 Torr of N₂ equivalent pressure.

NOTE: The same type of danger likely exists with other thermal conductivity gauges utilizing convection to extend the range to high pressures; and with Convector Gauges calibrated for gas type Y when used with gas type X.

Understand that, with a Convector Gauge calibrated for N₂ or Ar, to measure the pressure of gases other than air, N₂, and Ar you must use the conversion curves specifically for the Convector Gauge to translate between indicated pressure and true pressure. Do not use other data. Never use conversion curves for the Convector Gauge with gauges of other manufacturers. Their geometry is very likely different and dangerously high pressures may be produced even at relatively low pressure indications. **Also, you must ensure that the atmosphere adjustments for Convector Gauges A and B are correctly set. See Section 4.9 on page 4-29.**

Figures 4-9 through 4-14 show the true pressure vs. indicated pressure for eleven commonly used gases. Table 4-5 on page 4-20 will help to locate the proper graph.

Table 4-5 Pressure vs. Indicated N₂ Pressure Curve

Fig. No.	Pressure Range and Units	Gases
4-9	10 ⁻⁴ to 10 ⁻¹ Torr	All
4-10	10 ⁻¹ to 1000 Torr	Ar, CO ₂ , CH ₄ , Freon 12, He
4-11	10 ⁻¹ to 1000 Torr	D ₂ , Freon 22, Kr, Ne, O ₂
4-12	10 ⁻⁴ to 10 ⁻¹ mbar	All
4-13	10 ⁻¹ to 1000 mbar	Ar, CO ₂ , CH ₄ , Freon 12, He
4-14	10 ⁻¹ to 1000 mbar	D ₂ , Freon 22, Kr, He, O ₂

Note that 1 mbar = 100 Pa, so the mbar charts may be used for Pascal units by multiplying the values on the axes by 100.

A useful interpretation of these curves is, for example, that at a true pressure of 2 x 10⁻² Torr of CH₄ the heat loss from the sensor is the same as at a true pressure of 3 x 10⁻² of N₂ (see Figure 4-10 on page 4-23). The curves at higher pressure vary widely from gas to gas because the thermal losses at higher pressures are greatly different for different gases.

If you must measure the pressure of gases other than N₂ or air, use Figures 4-9 through 4-14 to determine the maximum safe indicated pressure for the other gas as explained below.

4.7.2 Examples

Example 1 – Maximum safe indicated pressure.

Assume a certain system will withstand an internal pressure of 2000 Torr or 38.7 psia. For safety, you wish to limit the maximum internal pressure to 760 Torr during backfilling. Assume you wish to measure the pressure of Freon 22. On Figure 4-11 on page 4-24, locate 760 Torr on the left hand scale, travel to the right to the intersection with the Freon 22 curve, and then down to an indicated pressure of 11 Torr (N₂ equivalent). Thus, in this hypothetical situation, the maximum safe indicated pressure for Freon 22 is 11 Torr.

For the sake of safety, it is prudent to place a warning label on the instrument face which under the assumed conditions would read "DO NOT EXCEED 11 TORR FOR FREON 22".

If the Convectron Gauge calibration is for a gas type other than air, N₂ or Ar, we suggest placing a label, supplied with the installation hardware, to the right of the second and third lines of the display indicating the gas type or types used for calibration to prevent mix-ups.

Example 2 – *Indicated to true pressure conversion.*

Assume you wish to determine the true pressure of helium in a system when the Convectron is indicating 10 Torr. On Figure 4-10 on page 4-23, read up from 10 Torr (N₂ equivalent) indicated pressure to the Helium curve and then horizontally to the left to a true pressure of 4.5 Torr. Thus 4.5 Torr Helium pressure produces an indication of 10 Torr (N₂ equivalent).

Example 3 – *True to indicated pressure conversion.*

Assume you wish to set a process control setpoint at a true pressure of 20 Torr of CO₂. On Figure 4-10 on page 4-23, locate 20 Torr on the true pressure scale, travel horizontally to the right to the CO₂ curve and then down to an indicated pressure of 6.4 Torr (N₂ equivalent). Thus the correct process control setting for 20 Torr of CO₂ is 6.4 Torr (N₂ equivalent).

Example 4 – *True to indicated pressure conversion.*

Assume you wish to obtain a helium pressure of 100 Torr in the system. On Figure 4-10 on page 4-23, locate 100 Torr on the left hand scale, travel horizontally to the right to attempt to intersect the He curve. Because the intersection is off scale, it is apparent that this true pressure measurement requirement for helium exceeds the capability of the instrument.

For gases other than those listed, the user must provide accurate conversion data for safe operation. The Convectron Gauge is not intended for use above approximately 1000 Torr true pressure.

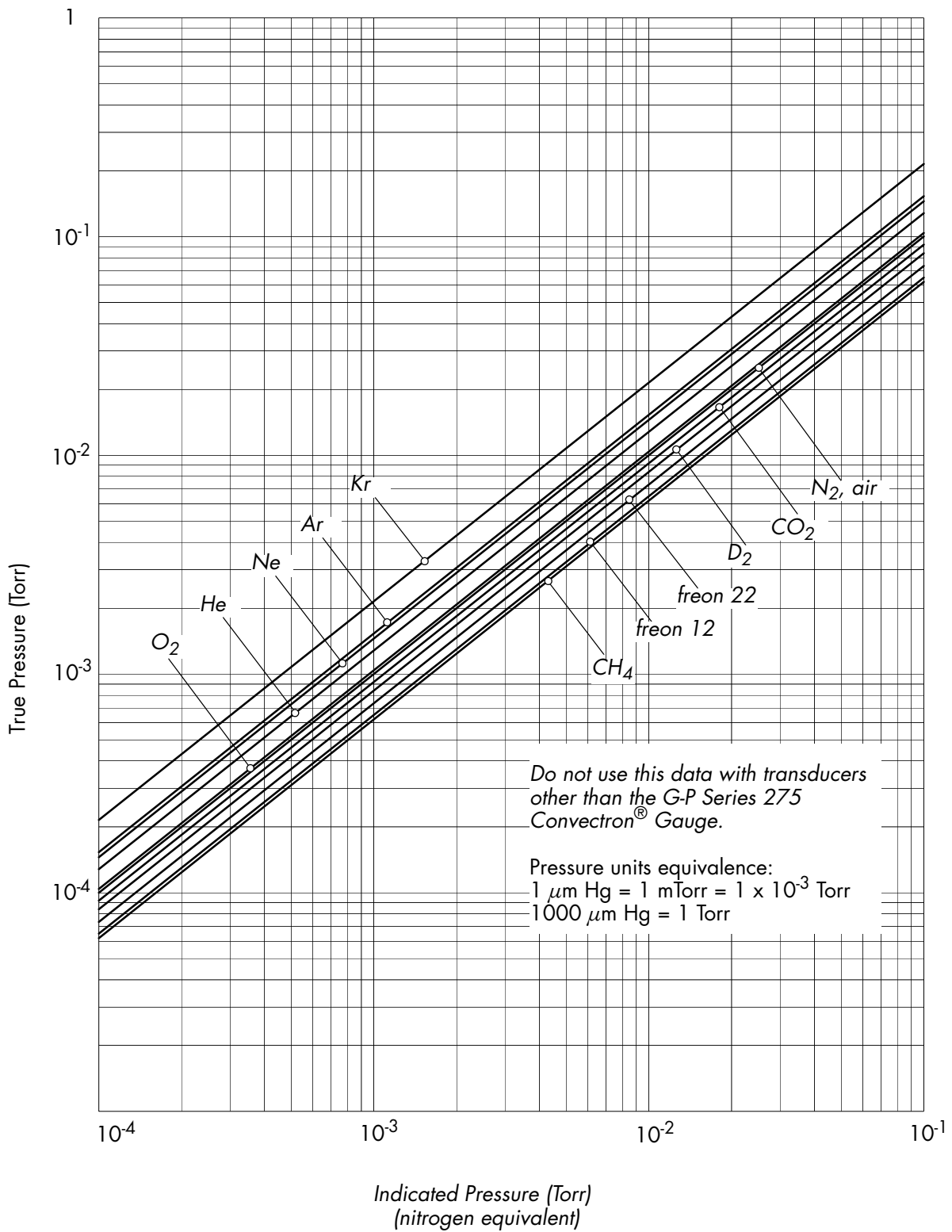

Figure 4-9 Convectron Gauge Indicated vs. True Pressure Curve; 10^{-4} to 10^{-1} Torr

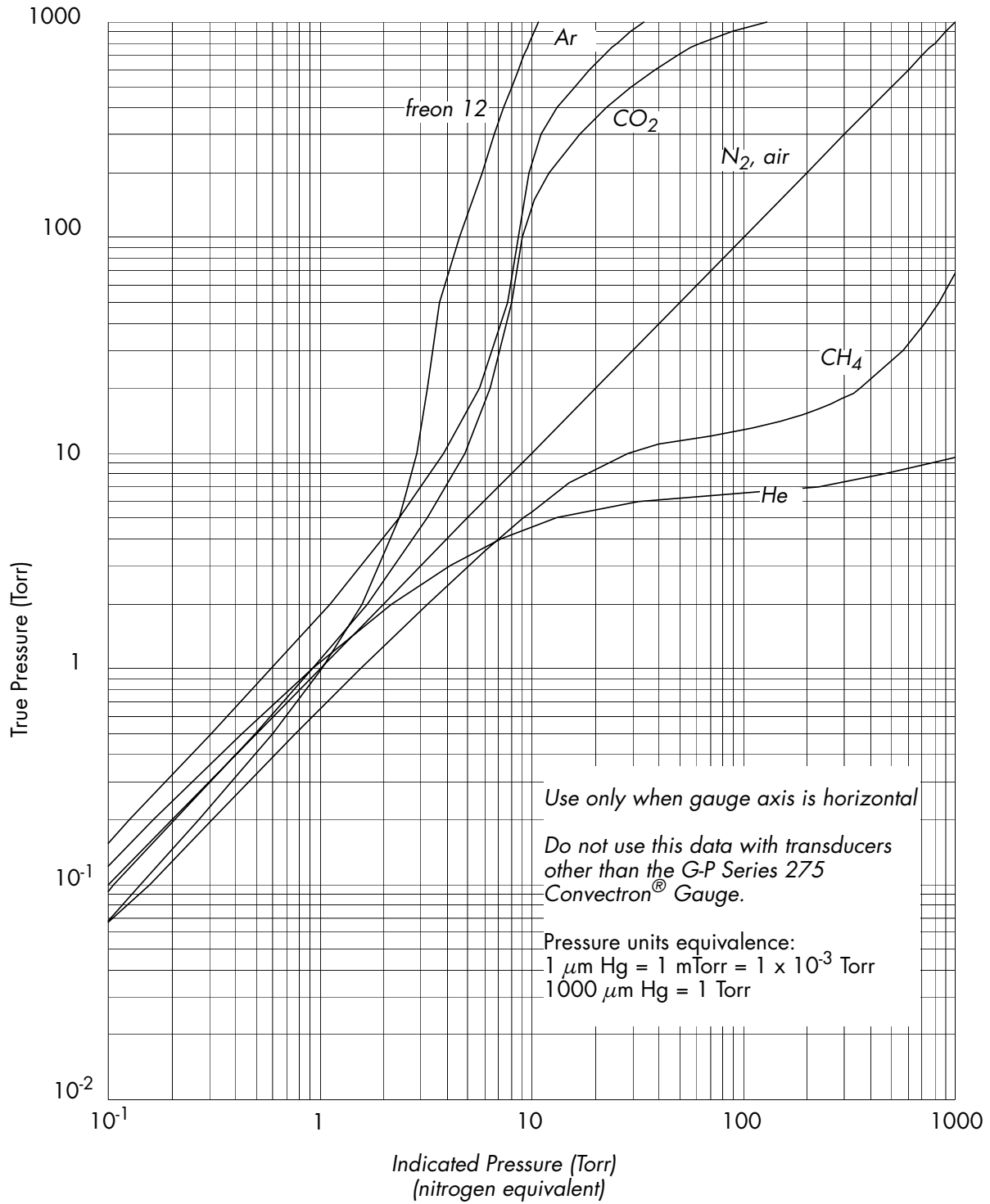

Figure 4-10 Convectron Gauge Indicated vs. True Pressure Curve; 10^{-1} to 1000 Torr

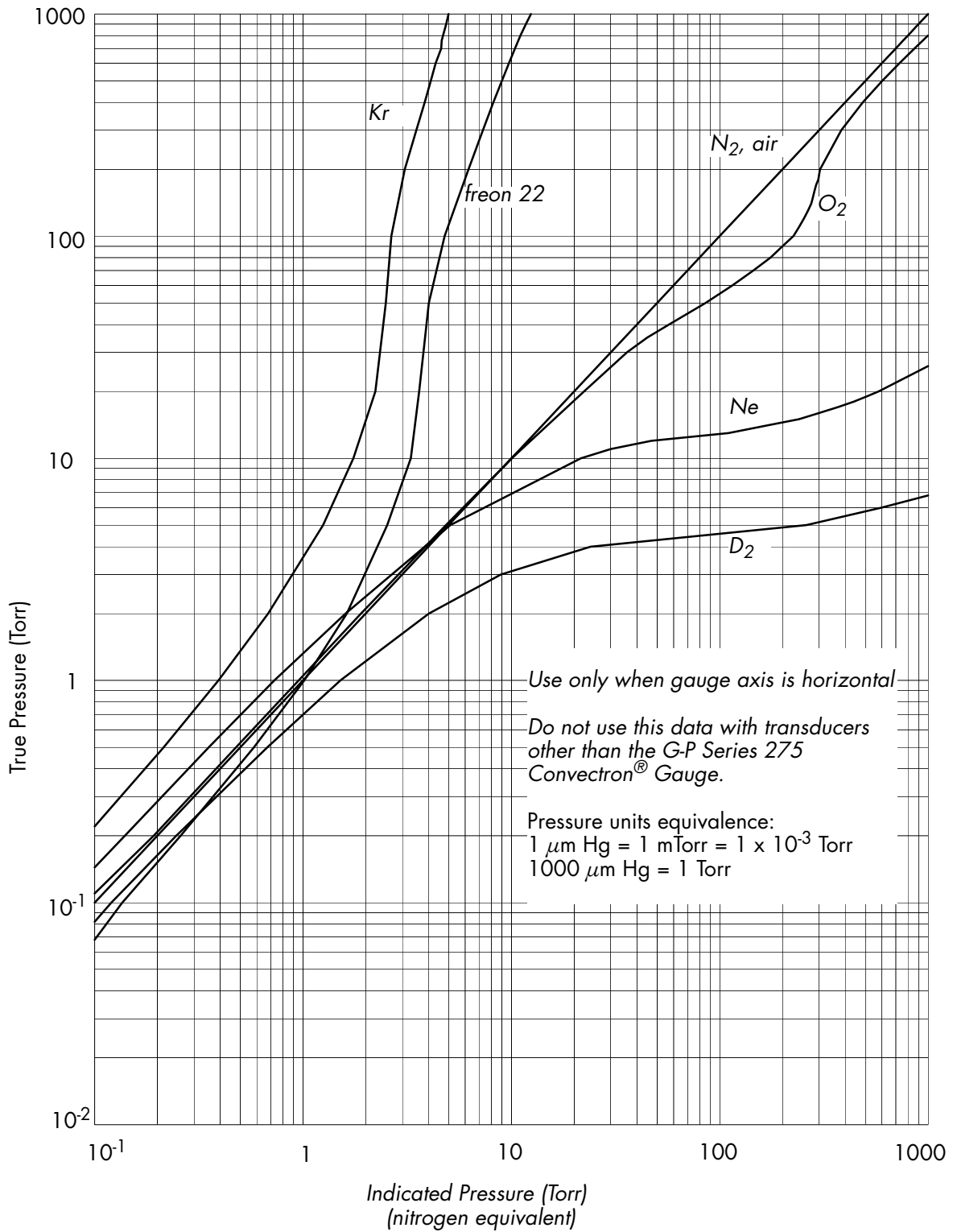

Figure 4-11 Convectron Gauge Indicated vs. True Pressure Curve; 10^{-1} to 1000 Torr

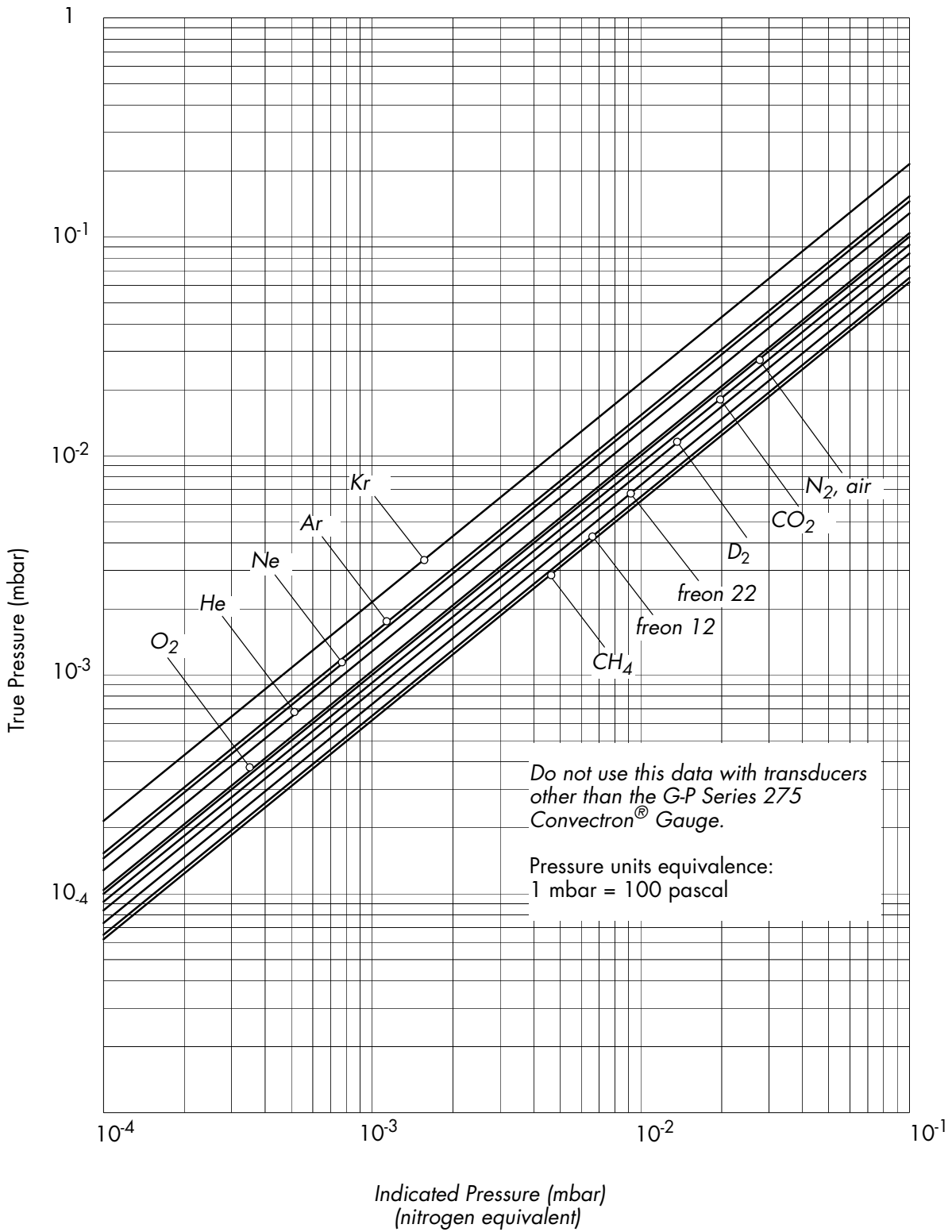

Figure 4-12 Convectron Gauge Indicated vs. True Pressure Curve; 10^{-4} to 10^{-1} mbar

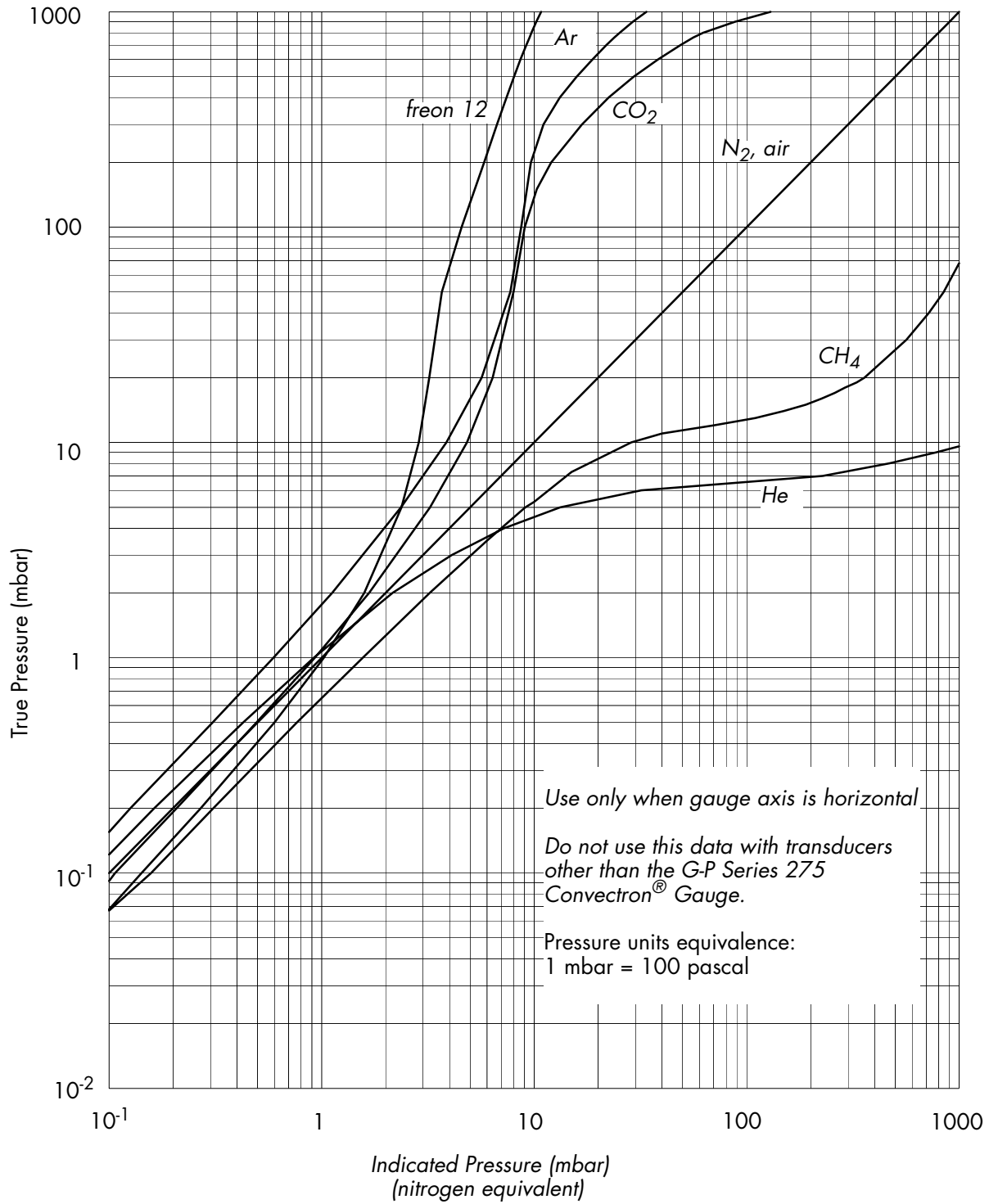

Figure 4-13 Convectron Gauge Indicated vs. True Pressure Curve; 10⁻¹ to 1000 mbar

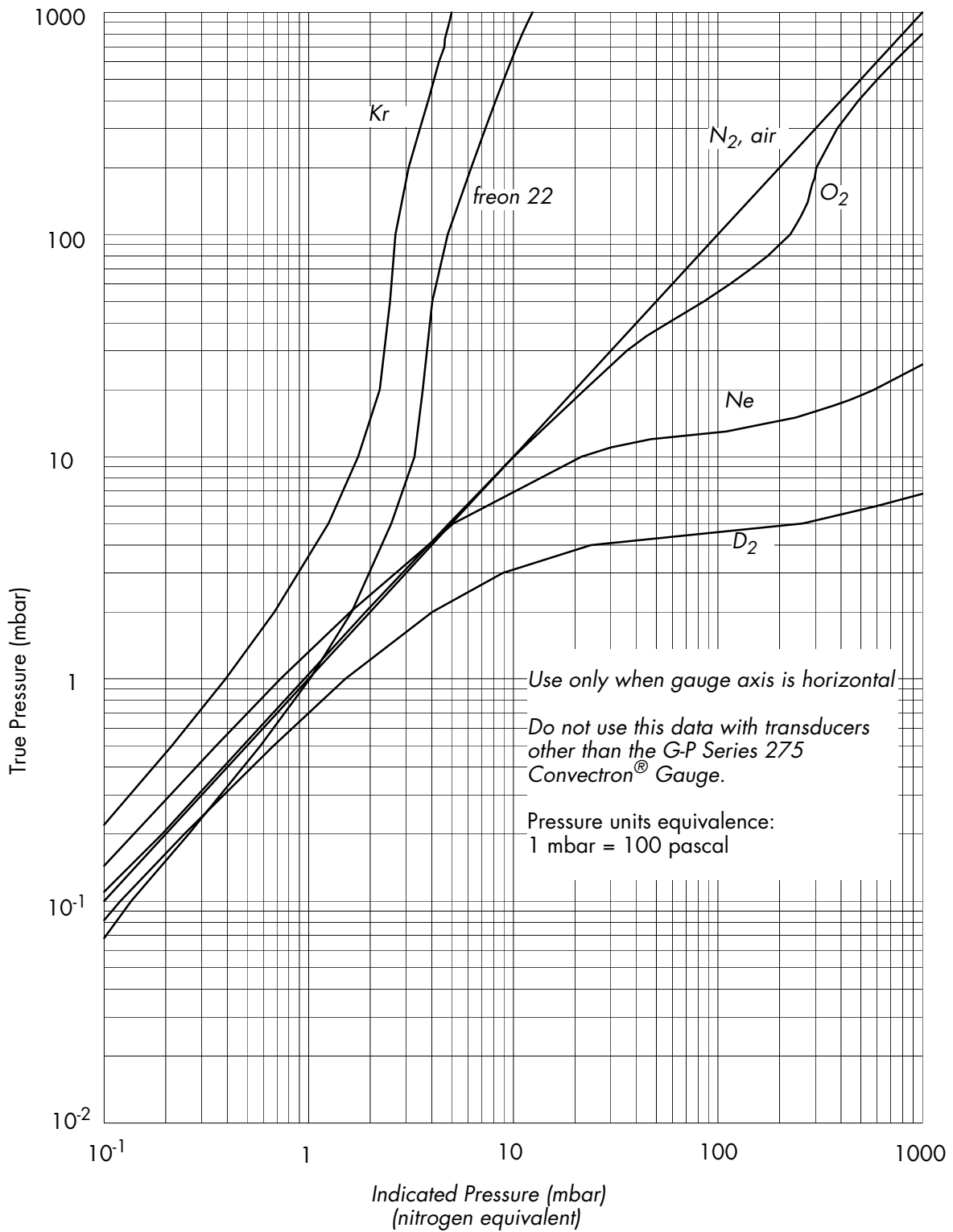

Figure 4-14 Convectron Gauge Indicated vs. True Pressure Curve; 10^{-1} to 1000 mbar

4.8 Ionization Gauge Auto Turn On/Off



Warning – If used improperly, Convector Gauges can supply misleading pressure indications that can result in dangerous overpressure conditions within the system. For use with gases other than air or N₂, consult the gas type correction charts in Section 4.7.1 on page 4-19, or use a Memory Module programmed with data for the specific gas being used.

If a Convector Gauge is exposed to the same pressure environment as a Stabil-Ion Gauge, then the Convector Gauge may be used to automatically turn on the IG. Convector Gauge A can turn on IG1 and Convector Gauge B can turn on IG2. Stabil-Ion Gauge automatic turn-on occurs when the Convector Gauge pressure drops below the auto turn-on setpoint defined by the auto turn-on setting. The Stabil-Ion Gauge will also be turned off automatically when the pressure rises slightly above the auto turn-on setpoint if the electrometer overpressure setpoint does not trip first.

The automatic on/off function will execute only once per setpoint crossing. For example, if the IG is turned off manually when below the setpoint, the auto-on function will not turn it back on until the Convector Gauge pressure has risen above the setpoint and then dropped below it again.

4.8.1 To Set the On/Off Pressure for IG1/IG2

1. Place the AUTO switch for IG1 in the SET position. See Figure 4-15.

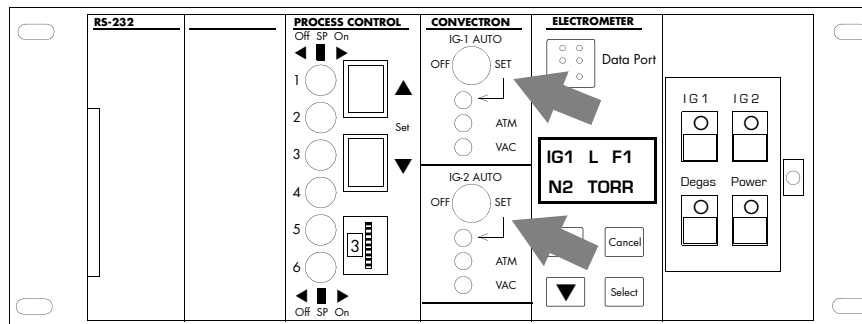

Figure 4-15 Control Unit Front Panel (with Door Open) Showing Ionization Gauge Auto Turn-On/Off Switches

2. The existing turn on pressure is displayed on the A display.
3. Set the desired turn on pressure with the AUTO adjustment for IG1.
4. To deactivate this capability place the AUTO switch for IG1 in the OFF position.
5. Set the Convector Gauge B/IG2 function the same way.

Do not leave either switch in the SET position as this prevents pressure from being displayed.

4.8.2 Convector Gauge Auto Turn On/OFF for the Convector/Capacitance Manometer Option

CGA can be used to automatically turn On IG1. Auto turn-on occurs when the CG pressure drops below the setpoint defined by the auto turn-on adjustment potentiometers. The IG will also automatically be turned Off when the pressure rises above this point.

The automatic Off/On function will execute only once per setpoint crossing. For example, the IG may be turned Off manually when below the setpoint, and the auto-on function will not turn it back On again until CG pressure has risen above the setpoint and once again dropped below.

Only IG1 is turned on with the Convector/Capacitance Manometer potentiometer from Convector A. See Figure 4-16.

The auto turn-on potentiometer is marked with rough pressure calibration markings. To set the pressure at which the IG will turn On with falling CG pressure, and Off with rising pressure, simply adjust the pot to point to the desired pressure.

More precise control can be achieved by fixing the system pressure at the desired auto turn-on pressure, and adjusting the potentiometer slowly until the gauge comes On.

To disable the auto turn on function, adjust the CG auto turn-on pot completely counter-clockwise ("Off").

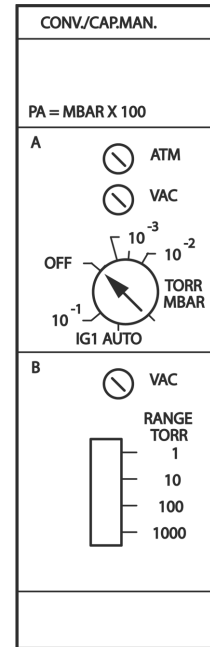

Figure 4-16 Convector / Capacitance Manometer Module Panel

4.9 Adjustment of Convector Gauge Zero and Atmospheric Pressure Indications

Using the N₂ calibration to pressurize a vacuum system above about 1 Torr with certain other gases can cause dangerously high pressures which may cause explosion of the system. See Section 4.7.1 on page 4-19 before using with other gases.

Each Convector Gauge is individually computer calibrated for N₂. Adjustment of the zero should not be necessary unless readout accuracy is required below 1×10^{-3} Torr or the gauge becomes contaminated and does not read correctly. Adjustment of the atmospheric indication should not be necessary unless compensating for long cables or variations in mounting orientation. The Convector Gauge has a stable, temperature compensated design and each controller is also calibrated to provide accurate readout of N₂, or Ar pressure with any gauge when properly installed with the gauge axis horizontal.

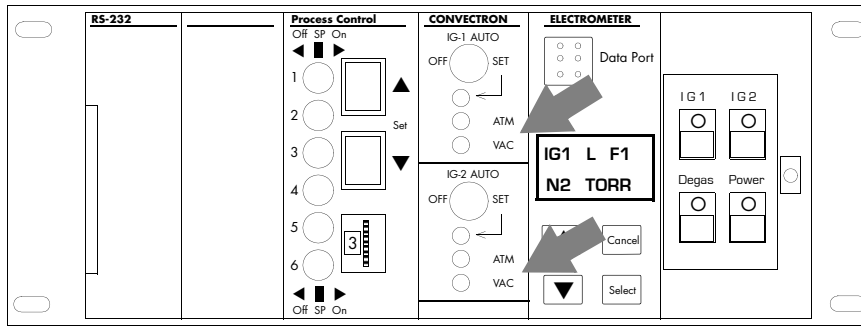

Figure 4-17 Control Unit Front Panel (with Door Open) Showing Convector Gauge Zero and Atmospheric Adjustments

For accurate readout, the vacuum and atmosphere adjustments must be made in the following order.

1. Evacuate Convector Gauge A to a pressure known to be less than 1×10^{-4} Torr.
2. With power on and at vacuum less than 1×10^{-4} Torr for at least 15 minutes, adjust VAC for gauge A (see Figure 4-17) until display A indicates 0.0 0 Torr/mbar or 0.0 0 Pa, not 1.0 -4, 1.0 -2, or 0.0 -0.
3. Let the pressure in the gauge increase to the local atmospheric pressure.
4. Read the local atmospheric pressure on an accurate barometer nearby.
5. With the power on, adjust ATM adjustment A (see Figure 4-16 and Figure 4-17) until gauge display A indicates the local atmospheric pressure in the pressure units you have selected.
6. Repeat the above steps for Convector Gauge B.

NOTE: 1 atmosphere normal at sea level = 7.6×10^2 Torr = 1.0×10^3 mbar = 1.0×10^5 Pa.

4.10 Convector Gauge Analog Output Signal

If the Convector Gauge capability is installed, a voltage output signal proportional to the common logarithm of the pressure indication is provided on the rear panel of the Convector Gauge module via a standard 1/8 in. miniature phone jack.

If graphed on log-linear axes, the output voltage is linear with respect to the log of pressure. The analog output is 1 volt per decade of pressure with a factory adjusted output of 0 volts at 1.0×10^{-4} Torr.

Offset adjustments are provided on the top edge of the Convector Gauge module that allow shifting the voltage corresponding to 1×10^{-4} Torr between -7 volts and +1 volt.

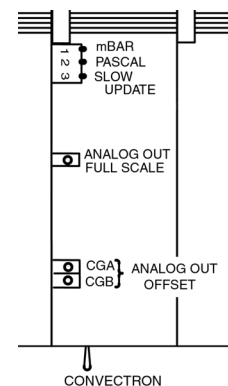

Figure 4-18 Top View of Convector Gauge Module Showing Analog Output Offset Adjustment

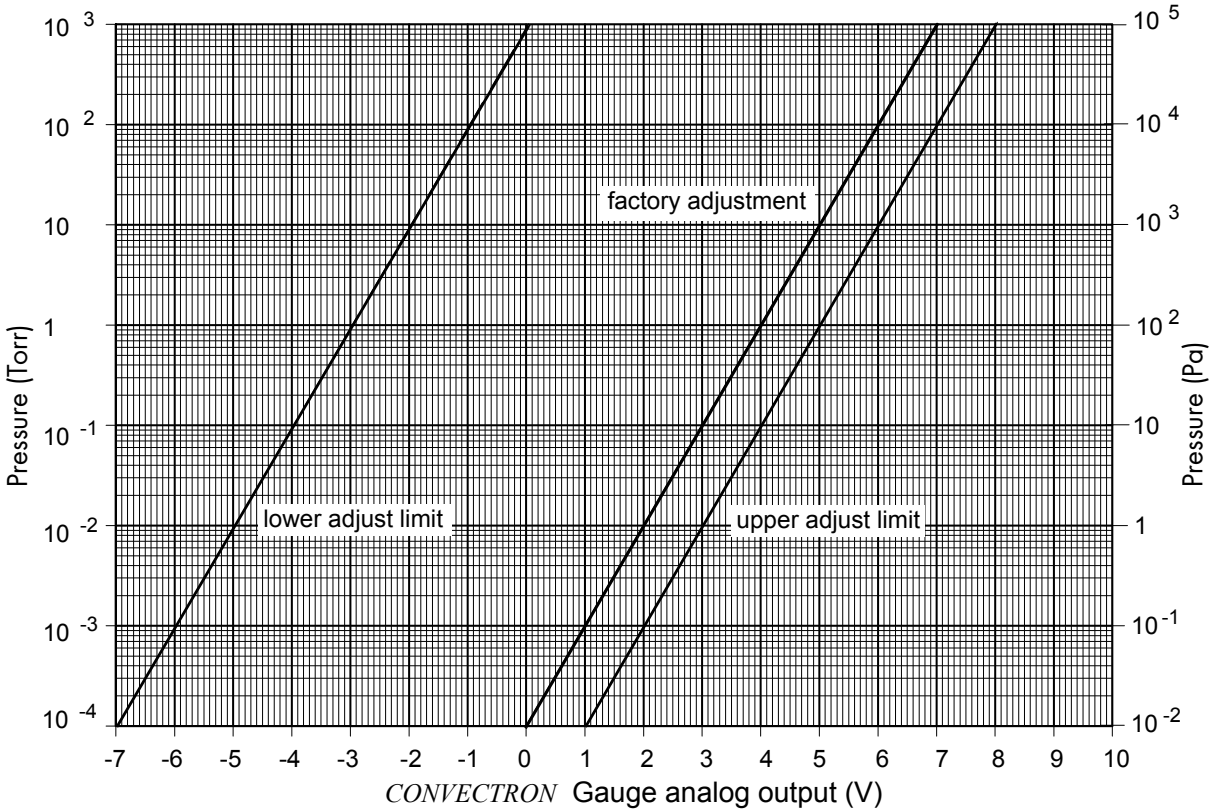

Figure 4-19 Convectron Gauge Analog Output vs. Pressure

The voltage signal is smooth and continuous throughout all the decades of pressure measurement. This format is useful for computerized data acquisition because a simple equation (finding the common antilogarithm) may be programmed to calculate pressure from the voltage output.

The equation is: $P_i = 10^{V-4}$ Torr/mbar, or $P_i = 10^{V-2}$ Pascal

where P_i = pressure indication,
 V = analog output voltage

and: the offset is at the factory adjusted 0V at 10^{-4} Torr (10^{-2} Pa).

If the offset has been adjusted to other than 0V at 10^{-4} Torr (10^{-2} Pa), then the exponent value must be forced to -4 (-2 for Pa) when the pressure is at 1.0×10^{-4} Torr (10^{-2} Pa) by adding or subtracting a number other than -4 from the value of V .

For example, if the offset has been adjusted so that the output voltage is -7 V at 10^{-4} Torr (10^{-2} Pa), then +3 (+5 for Pa) must be used in the equation instead of -4, i.e., $P = 10^{(-7+3)}$. Furthermore for the same offset, if the pressure were, say, 10^{-2} Torr, then the output voltage would be -5V. The pressure would be calculated as $P = 10^{(-5+3)}$.

4.11 Preparing for Capacitance Manometer Operation

The capacitance manometer pressure is read in the third display line of the 370 controller. The accompanying Convectron gauge is read in the second display line. If the cable is disconnected, the capacitance manometer will read Zero pressure.

4.11.1 Initial Transducer Calibration

When first installed, the transducer zero-adjust should be set using a voltmeter to read Zero when at a system pressure below the minimum pressure range of the transducer. Refer to the documentation accompanying your capacitance manometer transducer for instructions on this procedure. You should also at this time adjust the VAC on the 370 controller, with the gauge not attached to the controller, per the instructions below. After this initial setup has been performed, the routine fine-tuning of the transducer zero can be performed with the module front panel VAC (zero) adjust potentiometer. The zero can be adjusted to 0 ± 200 mV.

4.11.1.1 Set The Controller Zero (Initial Controller Setup)

1. Disconnect the capacitance manometer cable either at the gauge head or at the controller.
2. Adjust the vacuum potentiometer (Figure 4-20) until the third display line shows a single "0". If the adjustment is turned too far, a minus sign will appear in the display. This proper calibration is achieved when only the "0" appears.

4.11.1.2 Zero the 370 Controller with the Transducer:

1. Be sure the transducer was zeroed properly on initial installation, see your transducer documentation. Connect the cable from the 370 Controller to the capacitance manometer transducer.
2. Evacuate your system to below the minimum rated pressure of your transducer.
3. Adjust the vacuum potentiometer (Figure 4-20) until the third display line shows a single "0". If the adjustment is turned too far, a minus sign will appear in the display. This proper calibration is achieved when only the "0" appears.

Calibration of the Convectron should be performed per Section 4.9 on page 4-29 in this manual.

Figure 4-20 Convectron / Capacitance Manometer Module Panel

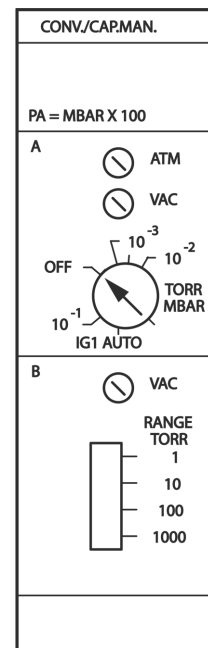

4.12 Capacitance Manometer Analog Output Signal

The analog output for the capacitance manometer is a dc voltage proportional to the pressure with a range of 0 to 10 volts, proportional to the transducer output. Refer to the documentation provided with your transducer for a description of this output.

Internal adjustments are provided for zero offset and full-scale (gain) control.

4.12.1 Capacitance Manometer Analog Output Offset Adjustment

Adjust the *CM Analog Output Offset* potentiometer to set the analog output 2 at Zero pressure. The output can be adjusted between -0.2 and +0.2 volts at Zero pressure.

4.12.2 Capacitance Manometer Analog Output Full-scale Adjustment

This is a span or gain control, with a range of 0.93 to 1.3. The factory setting is for a gain of 1.0, thus 10 volts in from the transducer (maximum readable pressure) = 10 volts out at the factory setting.

4.12.3 Capacitance Manometer Full-scale Adjustment

This potentiometer controls the full-scale readout of the capacitance manometer display. The control is adjusted at the factory for a full-scale display with an input of 10.0 volts. After zeroing the Series 370 Controller as described above, the Controller can be calibrated to the transducer by adjusting the full-scale adjust pot so the Controller display corresponds to the pressure of the manometer at or near the maximum pressure.

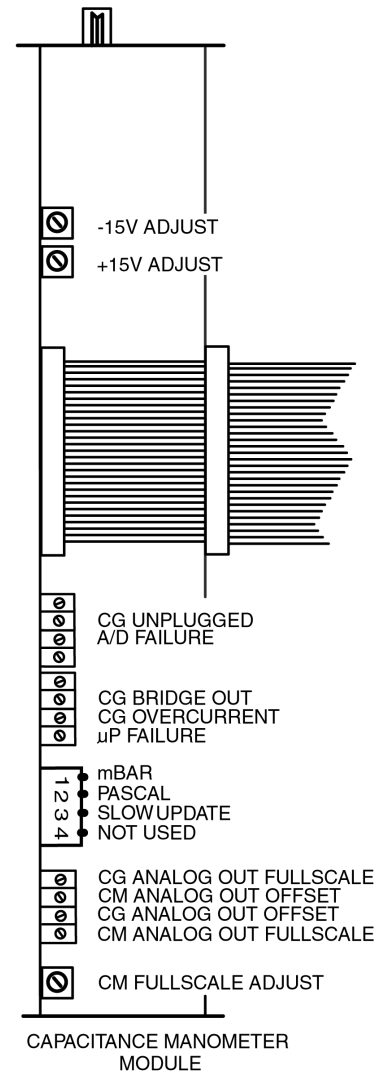

Figure 4-21 Convectron / Capacitance Manometer Adjustment Potentiometers

This reference pressure may be determined by a certified standard gauge, a dead weight calibration system, or a standard voltage reference. The full-scale adjust pot and the CM analog out full-scale pot do not interact and may be adjusted independently.

4.12.4 Convectron/Capacitance Manometer Analog Output Signal

If you have a Capacitance Manometer capability installed, signal voltages are provided on the back of the Convectron Gauge module via a standard 1/8 in. miniature phone jack - the Analog Output B port shown in Figure 4-22. Two mating connectors are supplied with this capability. See Section 4.12 on page 4-33 pertaining to the characteristics of these signals.

The analog output for the Capacitance Manometer is a dc voltage proportional to the pressure with a range of 0 to 10 volts. Refer to the documentation provided with your transducer for a description of this output.

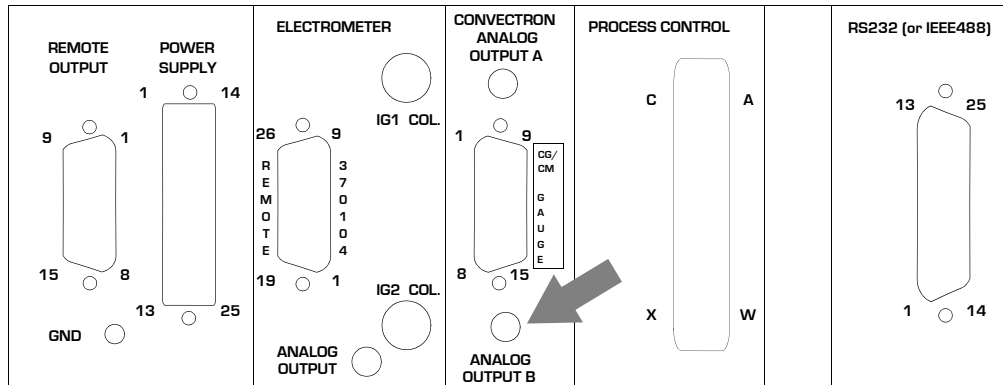

Figure 4-22 Convectron Gauge and Capacitance Manometer Analog Output Connectors on the Rear Panel of the Control Unit

Table 4-6 Capacitance Manometer Analog Output Voltage/Pressure

Volts	Pressure Torr	Pressure Torr	Pressure Torr	Pressure Torr
	1000 Torr Head	100 Torr Head	10 Torr head	1Torr Head
10	1000	100	10	1
1	100	10	1	.1
.1	10	1	.1	.01
.01	1	.1	.01	.001

Pressure = Volts multiplied by Scaling #

P = V times 100 (1000 Torr Head)

P = V times 10 (100 Torr Head)

P = V times 1 (10 Torr Head)

P = V times .1 (1 Torr Head)

4.13 Preparing for Process Control Operation

4.13.1 Setpoint Display and Adjustment

Setpoints are stored in non-volatile memory, and are specified by a 2-digit mantissa and 2-digit exponent. They may be set anywhere in the range 1.0×10^{-12} to $9.9 \times 10^{+5}$. This allows for the entire pressure range of the Stabil-Ion System and its units of measure to be covered.

The setpoint is compared directly to the display data, so units of measure are implicit. **Changing the units switch on the Controller will not change the stored setpoints.** They must be reprogrammed to the new units of measure.

If a setpoint is set to above atmosphere, then the relay will always be activated (unless its polarity is reversed, see Section 2.1.3 on page 2-4) except during transient conditions that occur, e.g. when the Stabil-Ion Gauge is first powered up, or a Convectron Gauge is disconnected. If it is desired that a process control relay be held in one state, the manual override switch should be used. If the setpoint is adjusted below 1.0×10^{-12} to 0.0, then it will always be deactivated (unless polarity is reversed).

4.13.2 To Display a Setpoint

1. Adjust the channel select thumbwheel to the number of the process control channel for which you wish to display the setpoint.
2. Press and release either the Up or Down SET button. The setpoint will appear for 2 seconds in the same display line as the associated gauge;
 - Setpoints 1 and 2 appear in the IG display line.
 - Setpoints 3 and 4 appear in display line A.
 - Setpoints 5 and 6 appear in display line B.

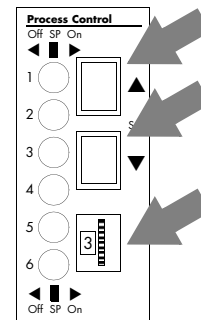

Figure 4-23 Electrometer Module Showing Setpoint Set Buttons and Channel Select Thumbwheel

4.13.3 To Modify a Setpoint

1. Adjust the channel thumbwheel to the number of the channel for which you wish to change a setpoint.
2. Press and hold the SET button for the direction you wish the setpoint to change; ▲ to raise the setpoint; ▼ to lower it (see Figure 4-23).
3. After holding the SET button in for about 5 seconds, the setpoint will scroll until the button is released. It will scroll slowly until a decade boundary is crossed and then will speed up to facilitate rapid changes across many decades. Release the button when you have entered the desired decade, and then depress it again to scroll slowly within the decade to reach the required setpoint.

After the setpoint button is released, the display will return to pressure data after 2 seconds. At this time the new setpoint will be stored in non-volatile memory and will not change when the Controller is turned off.

4.14 Preparing for use of the RS-232 Computer Interface

For set up instructions see Section 2.1.4 on page 2-8.

For connection instructions see Section 3.8 on page 3-13.

Check the user's manual for the host computer to be sure the protocol used is compatible with that established via the switch configuration in the RS-232 module.

Communication with the Control Unit is via ASCII strings. A message consists of a command and a command modifier, followed by a terminator. The message may contain leading spaces, and the command and modifier may be optionally separated by spaces or commas. No spaces may appear within the command or the modifier, only between them.

The terminator expected by the Control Unit is an ASCII carriage-return line-feed, denoted here by CRLF. The carriage-return is optional, and messages terminated with only the line-feed will be accepted. Note that the CRLF terminator is appended automatically by the host computer's interface software to the message string supplied by the user.

If extra characters are found in the message after it has been successfully interpreted but before the terminator, they will be ignored. Characters can be upper- or lower-case. All messages to 370 will receive a reply, consisting of an ASCII string of numbers and upper-case letters terminated with CRLF. Pressures will be returned in the format X.XXE±XX.

4.15 Preparing for use of the RS-485 Computer Interface

The Series 370 Controller uses a command-response half-duplex protocol. If the controller recognizes received data as a valid command, it will check the command string address and compare with its own. If the addresses match, the controller will process the command and then respond. In all configurations, only one twisted pair will have data transmissions in one direction at any time. The timing of the data transfer is shown in Figure 4-24 below. T_0 is 10-13 mS + 10 bit times with S2.1 in the OFF position, T_0 is greater than 700 microseconds with S2.1 in the ON position, and T_1 is greater than 300 microseconds. Adhering to these timing constraints will ensure data is not overwritten.

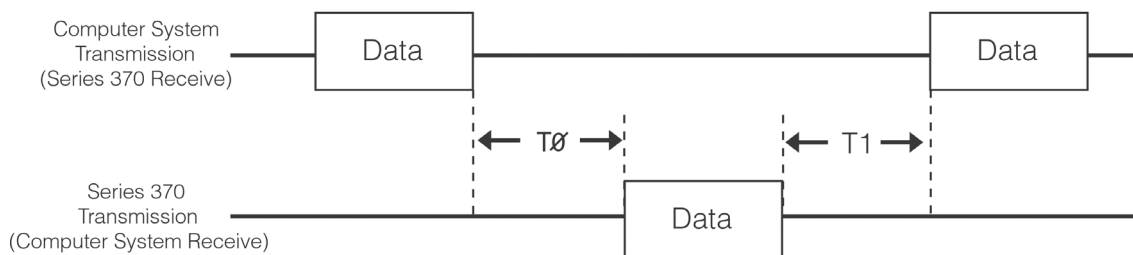

Figure 4-24 RS-485 Data Timing

Consult the user's manual for the host computer to be sure the character framing settings used are in accord with that established via the switch configuration you have chosen for the RS-485 module.

Communication is via ASCII strings. A message to consists of a start character "#", an address "AA", command, and a command modifier, followed by a terminator. The message may contain leading spaces, and the command and modifier may optionally be separated by spaces. No spaces may appear within the command or the modifier, only between them.

The address expected is programmed via the switch settings on the rear of the module. The syntax is "#AA" where AA is an ASCII representation of the hex address of the controller. The terminator expected is an ASCII carriage-return denoted here by CR. Note that the terminator is sometimes appended automatically, by the host computer's interface software, to the message string supplied by the user. If extra characters are found in the message after it has been successfully interpreted but before the terminator, they will be ignored.

All messages will receive a reply, consisting of an ASCII string terminated with CR. Pressure numbers will be returned in the format X.XXE±XX.

Messages may use upper or lower case alpha characters. The controller will always respond with upper case characters.

4.16 Preparing for use of the IEEE 488 Computer Interface

For set up instructions see Section 2.1.6 on page 2-14.

For connecting instructions see Section 3.10 on page 3-18.

Communication with 370 is via ASCII strings. A message to 370 consists of a command and a command modifier, followed by a terminator. The message may contain leading spaces, and the command and modifier may optionally be separated by spaces or commas. No spaces may appear within the command or the modifier, only between them.

The terminator accepted by 370 is an ASCII carriage-return line-feed, or New Line denoted here by CRLF. The carriage-return is optional, and messages terminated with only the line-feed will be accepted. Note that the CRLF terminator is, in general, appended automatically by the host computer's interface software to the message string supplied by the user.

A terminator is not required if the last character of the message to the 370 VGC is accompanied by the EOI bus signal from the IEEE488 interface. If extra characters are found in the message after it has been successfully interpreted but before the terminator, they will be ignored. Characters can be upper or lower case. Response characters will be upper case.

All messages to 370 will receive a reply consisting of an ASCII string terminated with CRLF; the LF being accompanied by an EOI. Pressures will be returned in the format X.XXE±XX.

4.17 RS-232, RS-485, and IEEE 488 Command Syntax

IG1

Definition: Turn IG1 on or off.

Modifiers: **ON** or **OFF**

Response: **OK** if command accepted, **INVALID** if rejected.

Example: From computer: **IG1 ONCRLF**

From 370: **OKCRLF**

NOTES

1. The **IG1 ON** command will be rejected as **INVALID** if IG1 is already on, and **IG1 OFF** will be rejected if IG1 is already off.

2. A response to the **IG1 ON** command of **OK** indicates only that a signal requesting that IG1 be turned on has been sent to the electrometer. IG1 may fail to come on, e.g., if the system pressure is too high or if the gauge is disconnected. To verify that IG1 is on, use the **DS IG1** command. If the gauge is off, or in its first few seconds of operation after being turned on, a pressure of **9.99E+9** will be returned.

IG2

Identical to **IG1**, but applies to IG2.

DG

Definition: Turn degas on or off

Modifiers: **ON** or **OFF**

Response: **OK** if command accepted, or **INVALID** if rejected.

Example: From computer: **DG ON CRLF**
From 370 **OKCRLF**

NOTES

1. Command is **INVALID** if neither IG is on.
2. A response to the **DG ON** command of **OK** indicates only that a signal requesting degas has been sent to the electrometer. Degas will not activate if the pressure is above 5×10^{-5} Torr. Use the **DGS** command (see below) to verify that degas has been successfully initiated.

DS

Definition: Display pressure reading.

Modifiers: **IG1** or **IG2** or **IG** or **CG1** or **CG2**.

Response: ASCII string representing the pressure for the selected gauge.

Example: From computer: **DS CG1 CRLF**
From 370: **1.25E-03CRLF**

NOTES

1. The **DS CG1** and **DS CG2** commands are used to display the pressures from the lower 2 display lines with the Convectron Gauge Module installed.
2. If the requested ion gauge is turned off, or is in its first few seconds of operation, or data is requested from a Convectron Gauge when none is installed, the Control Unit will return 9.90E+09.

The **DS IG** command will return pressure from the gauge which is on, and **9.99E+09** if neither is on.

DGS

Definition: Display degas status.

Modifiers: None

Response: ASCII **1** if degas is on, **0** if degas is off.

Example: From computer: **DGS CRLF**
From 370: **1CRLF**

CATH1

Definition: Select Filament 1, Filament 2, or both filaments for IG1 operation.

Modifiers: **1, 2, or B**

Response: **OKCRLF**

Example: From computer: **CATH1 2 CRLF**
From 370: **OKCRLF**

NOTES

This function can be implemented from the electrometer front panel or from the remote setup connector as well as from the computer interface.

CATH2

Identical to **CATH1** except applies to IG2.

PR1

Definition: Select pressure range for IG1 operation.

Modifiers: **L or H**

Response: **OKCRLF**

Example: From computer: **PR1 L**
From 370: **OKCRLF**

NOTES

This function can be implemented from the electrometer front panel, the remote setup connector, from the computer interface.

PR2

Identical to PR1 except applies to IG2.

GAS IG1

Definition: Select the gas calibration for the selected gauge.

Modifiers: a or b

Response: **OK** if accepted, or **INVALID** if rejected.

Example: From computer: **GAS IG1 a**
From Controller: **OKCRLF**

GAS IG2

Identical to **GAS IG1** except applies to IG2.

GAS CGA

Identical to **GAS IG1** except applies to CGA.

GAS CGB

Identical to **GAS IG1** except applies to CGB.

FPS

Definition: Front Panel Status. Displays the status of the current tube setup condition.

Modifiers: None

Response:

		0	1
IG1	gas	a	b
	pressure range	L	H
	filament operation	single	both
	filament #	1	2
IG2	gas	a	b
	pressure range	L	H
	filament operation	single	both
	filament #	1	2
CGA	gas	a	b
CGB	gas	a	b

Example: If the Controller is set as follows: for IG1 – gas a, pressure range low, single filament operation, filament #1; and for IG2 – gas b, pressure range high, both filaments operating CGA gas b, CGB gas b, then the response would be:

0, 0, 0, 0, 1, 1, 1, 0,1,1 CRLF

SWS

Definition: Display status of gauge control switches/remotes.

Modifiers: None

Response:

	0	1
IG1 filament #	1	2
IG2 filament #	1	2
IG1 pressure range	L	H
IG2 pressure range	L	H

Example: If the Controller is set for pressure range 1 low, pressure range 2 high, filament 1 #1, and filament 2 #2, then the response would be: **0,1,0,1 CRLF**

PCS

Definition: Display process control channel status.

Modifiers: **1** or **2** or **3** or **4** or **5** or **6** or **B** or none.

Response: Depends on modifier:

Modifier = single digit (1 through 6); response = single ASCII digit, **0** if the corresponding relay is inactive, **1** if active. See Example 1.

Modifier = **B**; response = a byte of data with bits 0 through 5 set/clear according to whether the corresponding relay is active/inactive. Bit 6 will always be set to guarantee that the returned byte will not appear as a terminator byte. See Example 2.

Modifier absent; response will be a string of 6 ASCII 0's and 1's separated by commas giving the status of all six channels. See Example 3.

Examples: Assume that channels 1 - 3 are active, and 4 - 6 are inactive:

1. From computer: **PCS 1 CRLF**

From 370: **1CRLF**

2. From computer: **PCS B CRLF**

From 370: **GCRLF**

(Note that ASCII "G" corresponds to the bit pattern 01000111 and represents the status of the PC channels in bits 0 through 5).

3. 3.From computer: **PCS CRLF**

From 370: **1,1,1,0,0,0 CRLF**

GTL

Definition: Send control back to the electrometer front panel settings.

Modifiers: None

Response: **OK** if command accepted, or **INVALID** if rejected.

LLO

Definition: Local lockout of the electrometer front panel gauge control settings.

Modifiers: None

Response: **OK** if command accepted, or **INVALID** if rejected.

Error Messages

If an error is found in the incoming message, the following messages will be returned in place of the normal response.

OVERRUN ERROR - Returned if the incoming message overflows 370's buffer.

SYNTAX ERROR - Returned if the message fails to parse as a valid 370 command.

4.18 Gauge Serial Number Display and Channel Data Swapping

4.18.1 Stabil-Ion Gauge Serial Number Display and Channel Data Swapping

If there is a need to swap the data in the internal data tables due to a change in the location of the Stabil-Ion Gauge with respect to cable or channel number, there is a provision to swap gauge memory data into an area called TMP. This TMP area is also used to store data from the Memory Module when a module has been plugged in for more than 15 seconds after power up. The TMP area is cleared of data when the Controller is powered down and powered up. In the following

example, we want to swap what is in IG1 gas a table (i.e. Serial No. A data) with what is in IG2 gas a table (i.e. Serial No. B data.) The symbol # will be used to represent a clear memory table. To do this you need to make the following swaps of data:

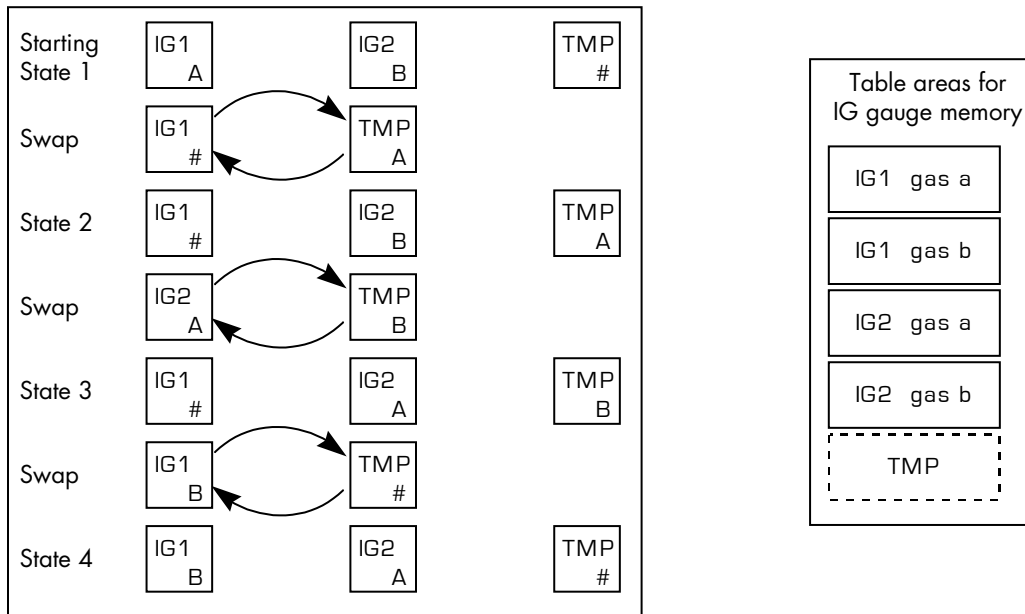

The numbers in the display correspond to the Serial Tag Numbers on the Stabil-Ion Gauge tubes. The way to change data from TMP to IG2 gas table location is as follows:

- Press the ▼ arrow key to display the swap information.

IG TMP 00
#####

take note of Serial No.
- Press the ▼ arrow key again to display the swap message.

Swap ???
Be Sure!
- Press the SELECT key to begin the swap action.

Swap TMP
& IG1 a
- Use the ▲ or ▼ arrow keys to select the desired gauge to swap data with.

Swap TMP
& IG2 a
- Press the SELECT key to swap the data files.

Hit SLCT
To Swap!
- Press the SELECT key again to complete the swap action.

Updating
Changes!
- Use the ▲ or ▼ arrow keys to check the results.

IG TMP 00
#####

- Press CANCEL to return to the serial number display.
Press CANCEL again to return to the INFO Menu.
(Press CANCEL yet again to return to the status display for the gauge tube that is turned on.)

Serial
IG No.'s

Info
Menu

*NOTE: Be sure to complete data swapping before turning off the Controller.
The IGTMP area is cleared when the power is turned off.*

4.18.2 Convectron Gauge Serial Number Display and Memory Data Swapping

From the factory, the Convectron memory will have two average memory data curves programmed. The serial number of the gauge, and the CG channel or gas type to which it is assigned, is displayed using the Serial # function under the INFO Menu.

- Press the ▼ arrow key until you see the information menu.
- Press the SELECT key to see the serial number display.
- Press the ▼ key again to see the CGA (a) gauge serial number.
- Press the SELECT key to select the CG data area.
- Press the ▼ arrow key to view the desired serial number display. Press ▼ repeatedly to view the successive displays (e.g. CGA a, or CGB b,...).

Info
Menu

Serial
IG No.'s

Serial
CG No.'s

CGA 00
#####

CGB 00
#####

If you don't need to swap data, or if both memory curves are averaged data, skip to step 13.

If you want to swap the channels, CGA and CGB, for the serialized tube data, there is a data swapping area called CG TMP where data can be exchanged. The numbers in the display correspond to the Serial Numbers on the Convectron Gauge tubes. The way to change data from CGB to TMP is as follows:

- Press the ▼ arrow key to display the swap information.
- Press the ▼ arrow key again to display the swap message.
- Press the SELECT key to see the swap action.
- Use the ▲ or ▼ arrow keys to select the desired gauge to swap data with.

CGTMPCG
#####

take note of Serial No.

Swap ???
Be Sure!

Swap TMP
& CGA

Swap TMP
& CGB

10. Press the SELECT key to swap the data files.

Hit SLCT
To Swap!

11. Press the SELECT key again to complete the swap action.

Updating
Changes!

12. Use the ▲ or ▼ arrow keys to check the results.

CGTMPCG
#####

13. Press CANCEL to return to the serial number display.
Press CANCEL again to return to the INFO Menu.
(Press CANCEL yet again to return to the status display for the gauge tube that is turned on.)

Serial
CG No.'s

Info
Menu

*NOTE: Be sure to complete data swapping before turning off the Controller.
The IGTMP area is cleared when the power is turned off.*

Operation of a Stabil-Ion System

The instructions in this chapter assume the instructions for Setup, Installation, and Preparing For Operation have been completed. See Chapters 2, 3, and 4.

1. Press the Power switch on the Control Unit to ON (see Figure 5-1).
2. Convectron Gauge pressures will be displayed on lines A and B of the display whenever the power switch is on. A “-” sign will be displayed if the Convectron gauge is unplugged. Capacitance manometer gauge pressures will be displayed on line B.

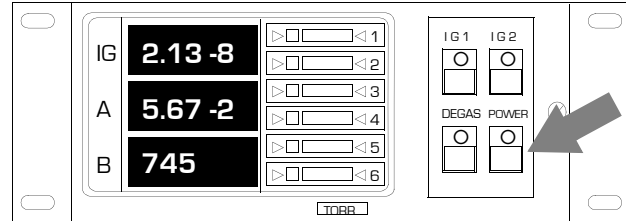

Figure 5-1 Control Unit Front Panel Showing Power ON Button

Table 5-1 Convectron Gauge Display Formats

Units	Display Format	Pressure	Example
torr	scientific	< 1 Torr	3.23-3 Torr
	floating point	> 1 Torr	7.15 Torr
mbar	scientific	< 1 mbar	5.18-2 mbar
	floating point	> 1 mbar	88.6 mbar
	scientific	> 999 mbar	1.23+3 mbar
pascal	scientific	< 1 Pa	7.23-1 Pa
	floating point	> 1 Pa	78.3 Pa
	scientific	> 999 Pa	1.25+4 Pa

During a fast pumpdown from atmosphere, thermal effects will prevent the Convectron Gauge from tracking pressure accurately below 10^{-3} Torr. After about 15 minutes, indications in the 10^{-4} range will be valid and response will be rapid. Zero adjustment at vacuum may be performed at this time (or sooner if readings in the 10^{-4} range are not needed).

In the 10^{-4} Torr range, the indication is accurate to about ± 0.1 millitorr provided the instrument has been carefully zeroed at vacuum. See Section 4.9 on page 4-29 for vacuum and atmosphere calibration procedures. For accurate use in the 10^{-4} range, zeroing should be repeated frequently.

3. If you have Convectron Gauge capability installed and have prepared your system for automatic operation of the Stabil-Ion Gauge(s) per Section 4.8 on page 4-28, the ionization gauge(s) will turn on and off automatically.
4. For manual operation, press the Stabil-Ion Gauge 1 (or 2) power switch, IG1 (or IG2), on the Control Unit. The pressure in Stabil-Ion Gauge 1 (or 2) will be displayed on the IG line of the display in the chosen pressure units.
5. To degas IG1 (IG1 must be on and the pressure within IG1 must be below 5×10^{-5} Torr), depress the DEGAS switch on the Control Unit (see Figure 5-2). When degassing with filament 1 or 2 selected, both filaments will operate in order to achieve full degas power and thorough cleaning of both filaments.

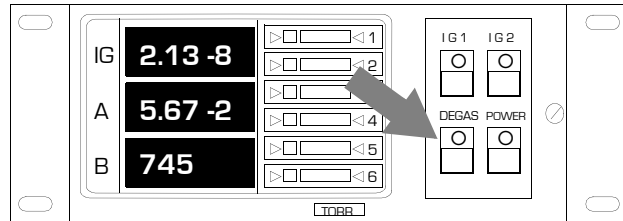

Figure 5-2 Control Unit Front Panel Showing DEGAS Button and LED Indicator

If one of the filaments is not operating, the degas will revert back to degassing the single selected filament at a reduced power.

6. When either filament is nearing the end of its useful lifetime or is badly contaminated, the DEGAS switch LED indicator on the front panel will blink during degassing (see Figure 5-2). This is an indication that the filament emission properties have deteriorated. This may be due to contamination which has temporarily “poisoned” the filament coating, or to long term permanent erosion of the coating.

If this condition does not disappear after a few days of operation at clean high vacuum, it is an indication that one or both filaments are approaching their end of life.

Stable pressure measurement requires that all the environmental parameters in, on, and around the vacuum gauge and vacuum system remain unchanged during measurement. Therefore, expect measurements immediately after turning on the Stabil-Ion Gauge or immediately after degassing the gauge to be less stable and less accurate. Permit sufficient time for the environmental parameters to stabilize.

Theory of Operation and Specifications

This chapter provides a brief explanation of the theory of operation and the general specifications for Stabil-Ion gauges, Convecatron gauges, and Capacitance Manometer gauges.

6.1 Stabil-Ion Gauge Theory of Operation

6.1.1 Operating Principles of Bayard-Alpert Ionization Gauges

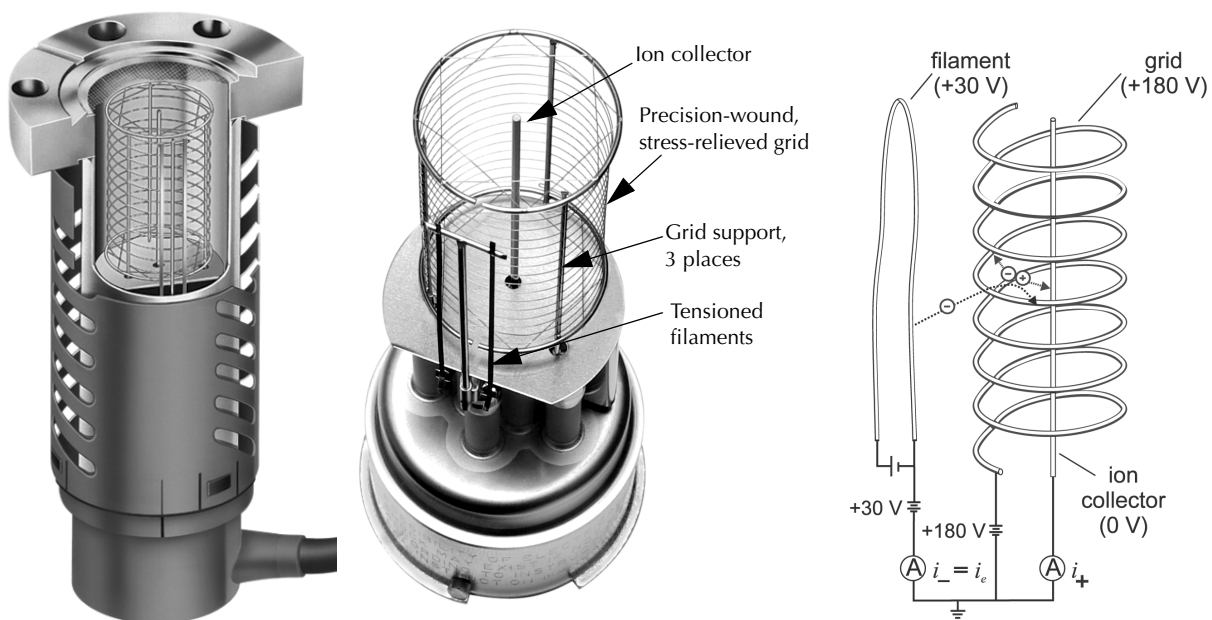

Stabil-Ion Gauge illustration shown with part of the stainless steel cover and heat shield removed.

Stabil-Ion Gauge shown with the stainless steel cover removed for clarity.

Principle of Operation: Electrons are created by a hot filament and accelerated to the grid. The current is actively controlled by the electronics.

Figure 6-1 Stabil-Ion Gauge Illustrations and Principle of Operation

A Bayard-Alpert (B-A) gauge is a hot-filament style ionization gauge. It is called such because a heated filament (cathode) is used to emit electrons toward a grid (anode).

The pressure indication of a B-A vacuum gauge is based on the ionization of the gas molecules by a constant flow of electrons. The negative electrons are emitted at a well-controlled, selectable rate from a heated filament (cathode) and are accelerated toward a positively-charged wire grid (anode). Electrons pass into the space enclosed by the grid. In this space the electrons collide with the gas molecules that are in the vacuum system, and produce positive ions. The positive ions are then collected by the ion collector that is located along the axis of the cylindrical grid. The ion collector is at nearly ground potential, which is negative with respect to the grid. At a constant filament-to-grid voltage and electron emission current, the rate that positive ions are formed is directly

proportional to the density of molecules (pressure) in the gauge for pressures below approximately 1×10^{-3} Torr. The strength of the ion current is then indicated on an electrometer that is calibrated in units of pressure.

Because the pressure indication is linear, the hot cathode B-A gauge is generally considered to be the most accurate continuous indicator for pressures below 1×10^{-3} Torr.

The development of the Stabil-Ion Gauge brought the accuracy of B-A technology to the 4% to 6% range. Although prior B-A style vacuum gauges were usually inaccurate as much as 20% to 50%, they were still the best, commonly available vacuum gauge in the 1×10^{-3} to 2×10^{-11} Torr range.

6.1.2 X Ray Limit of Bayard-Alpert Gauges

The low end of the operating range of a B-A gauge is determined by the x ray limit of this type of gauge. The x ray limit varies with different gauge designs. X rays are produced when the electrons emitted by the cathode impact the grid (anode). Because of the geometry of the B-A gauge, only a small fraction of the x rays emitted from the grid are intercepted by the ion collector. When the x rays strike the collector they cause electrons to be photoelectrically ejected from the collector. This photoelectron current from the ion collector is detected the same as positive ions arriving at the ion collector and consequently adds to the ion current. This x ray current limits the pressures that can be measured, and is equivalent to a pressure reading in the 10^{-10} to 10^{-11} Torr ranges. The x ray limit refers to the lowest pressure indication that may be obtained in a gauge when all the output current is due to x ray induced photoemission and there is an absence of gas.

The x ray limit of an Extended Range Stabil-Ion Gauge is approximately 2×10^{-10} Torr. To measure below this limit, an ultrahigh vacuum (UHV) Stabil-Ion gauge can be used. The UHV Stabil-Ion gauge has an x ray limit of approximately 2×10^{-11} Torr. This lower x ray limit is achieved by modifying two elements of the standard B-A gauge design. First, the diameter of the collector is reduced. The smaller cross-sectional area reduces the probability that the x rays created at the grid will strike the collector. Second, the helical grid structure is replaced with a fine-wire mesh grid structure, and there is also a fine-wire structure across both ends of the grid. The fine grid wires provide a more transparent grid for longer electron path lengths, and the grid ends confine the positive ions for better ion collection. Together, these two modifications cause a higher gauge sensitivity for ions from the gas phase which causes the x ray current to be converted into a smaller pressure indication (i.e., a lower x ray limit).

Some processes can result in deposits on the electrodes. These deposits can lead to an increase in x ray limit since more electrons are released under x ray bombardment. Process deposits can generally be removed by degassing the electrodes. See Degassing on the next page.

6.1.3 Filaments (Cathodes) used in Bayard-Alpert Gauges

There are two types of materials commonly used for filaments: tungsten and iridium. And, there are two types of coatings used on the filaments: thoria and yttria.

Generally, filaments are yttria-coated iridium, thoria-coated iridium, or uncoated tungsten. The most common style is coated iridium because they operate at a lower temperature than tungsten, therefore less reactive. Coated iridium filaments are also more burnout resistant when exposed to atmospheric pressure while power is on. Tungsten filaments will burn out immediately if exposed to pressures of 1×10^{-2} Torr or higher while they're on. However, tungsten filaments are the best type to use when the chemistry (such as halogen compounds) of the vacuum process causes premature failure of coated iridium filaments.

The amount of emission current that a B-A gauge requires for proper operation depends on many factors such as: the size or style of the gauge, the process in which the gauge is used, the pressure range of operation, and the desired accuracy of the indicated pressure. Emission currents are typically in the range of 25 μA to 10 mA.

6.1.4 Degassing Bayard-Alpert Gauges

The deposition of elements or compounds on exposed gauge surfaces can result from some processes, such as sputtering or coating operations. Water vapor is another compound that can collect inside the gauge when a vacuum chamber is exposed to atmosphere. During normal operation these materials will slowly come off the gauge surfaces, increasing the local pressure in the gauge. To more rapidly get the pressure in the gauge in equilibrium with the pressure in the chamber, "degassing" can be used to drive the molecules on the inner walls and surfaces from the gauge back into the chamber where they can be pumped out of the system. Degassing can be done as required or as part of a regular pumpdown sequence. Regular degassing helps prevent process deposits from collecting and allows the gauge to provide lower and more repeatable pressure indications by bringing the pressure in the gauge closer to equilibrium with the chamber.

Electron Bombardment (EB) degassing is accomplished by increasing the anode voltage and the emission current to bombard the gauge with electrons of sufficient quantity and energy to displace deposited molecules.

Cleaning a gauge with solvents is not recommended. However, if a gauge has been exposed to silicone-based pump oil, solvent may be needed to remove the oil. If solvent is used, the gauge must be thoroughly dried before installing it back on the system and operating or degassing it.

6.1.5 Stabil-Ion Gauge Specifications

Measuring range for N ₂ or Air 0.1 mA emission	4×10^{-9} to 2×10^{-2} Torr; 5 to 3×10^{-7} Pa; 5×10^{-9} to 3×10^{-2} mbar
4.0 mA emission (UHV)	2×10^{-11} to 5×10^{-4} Torr; 3×10^{-9} to 7×10^{-2} Pa; 3×10^{-11} to 7×10^{-4} mbar
4.0 mA emission (extended)	2×10^{-10} to 5×10^{-4} Torr; 3×10^{-8} to 7×10^{-2} Pa; 3×10^{-10} to 7×10^{-4} mbar
X ray limit of an Extended Range Stabil-Ion gauge	2×10^{-10} Torr; 3×10^{-8} Pa; 3×10^{-10} mbar
X ray limit of a UHV Stabil-Ion gauge	2×10^{-11} Torr; 3×10^{-9} Pa; 3×10^{-11} mbar (See notes, below)
Gauge operating temperature	0 °C to 50 °C ambient, non-condensing
Gauge bakeout temperature	450 °C maximum, non-operating, cable removed
Maximum gauge cable length	61 meters (200 feet)
	Notes regarding x ray limit: The x ray limit is the absolute lowest indication from the gauge. It is not practical to make repeatable measurements near the x ray limit.

6.2 Convectron Gauge Theory of Operation

The Convectron Gauge transducer is represented in Figure 6-2 as R1, R2, R3, and R4. These four resistances form the legs of a bridge circuit, with R1 designating the sensor wire of the transducer. R2 is a resistive network in the tube that compensates for changes in the ambient temperature. At bridge null, $R1=R2 \times R3/R4$. If there are no changes in ambient temperature, the value of R1 is a constant and the bridge is balanced.

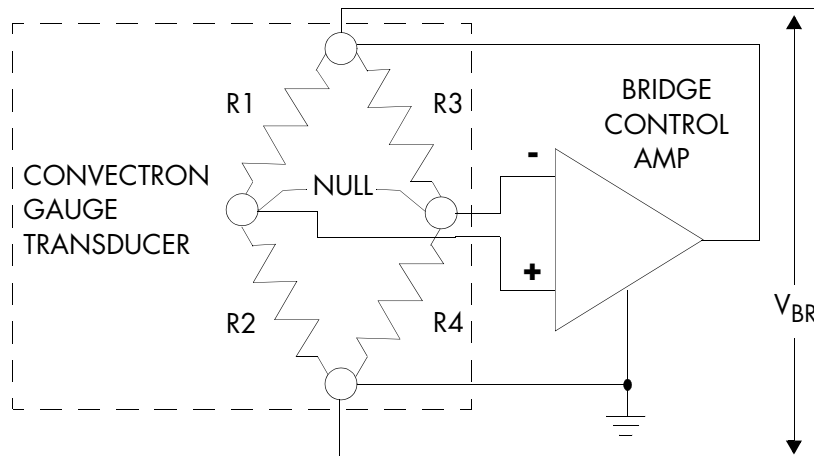

Figure 6-2 Simplified Schematic of Convectron Gauge

As the vacuum system pressure is decreased, there are fewer molecules in the system to conduct the heat away from the sensor wire causing the temperature and resistance of R1 to increase. The increased resistance of R1 causes the bridge to unbalance and a voltage is developed across the null terminals. The bridge control circuit senses the null voltage and decreases the voltage across the bridge until the null voltage is again zero. When the bridge voltage is decreased, the power dissipated in the sensor wire is decreased causing the resistance of R1 to decrease to its previous value. The opposite events happen for a pressure increase. The bridge voltage is a non-linear function of pressure.

All materials have been chosen for ultra high vacuum service, corrosion resistance and bakeability to 150 °C. The gauge tube envelope is type 304 stainless steel. All metallic joints in the envelope are TIG welded. No solder is used within the envelope. The following materials are exposed to the vacuum. Type 304 stainless steel, Carpenter Alloy 52, Kovar[®], Kapton[®], gold plated tungsten, borosilicate glass and Dow-Corning 9015 glass. The blue trim cover is molded of Ultem[®] polyetherimide resin suitable for service to 150 °C.

6.2.1 Convectron Gauge Specifications

Measuring range for N2 or Air	1×10^{-4} to 999 Torr; 1×10^{-2} to 1.33×10^5 Pa; 1×10^{-4} to 1.33×10^3 mbar
Mounting position	Horizontal preferred, with port down
Sensor material	Gold-plated tungsten
Gauge operating temperature	0 °C to 50 °C ambient, non-condensing
Gauge bakeout temperature	150 °C maximum, non-operating, cable removed
Cable bakeout temperature	105 °C maximum
Maximum gauge cable length	152 meters (500 feet)

6.3 Capacitance Manometer Gauge Theory of Operation

Within the capacitance manometer, a diaphragm is distorted by the pressure of the gas in the system under measurement. This diaphragm forms part of a capacitor, and its deflection causes changes in capacitance. Thus, the electrically measured capacitance is a measure of pressure. The device is very sensitive to the elastic properties of the metal of the diaphragm. For this reason, large pressure excursions, such as occur when the system is raised to atmospheric pressure, can cause offsets to the pressure reading. The diaphragm is also extremely sensitive to temperature effects, and although it may be held in a temperature controlled chamber, this temperature control is never perfect, resulting in further perturbations to the devices theoretical accuracy.

Note that these perturbations are inherent in the capacitance manometer design and are not a property of the electronic module used to operate the transducer.

Capacitance manometers are capable of exceptional accuracy, and read pressure independent of gas type, but are also subject to zero-point drift, and must be calibrated at vacuum frequently if high accuracy is to be obtained. Refer to the manual for your transducer for instructions.

6.3.1 Capacitance Manometer Gauge Specifications

Gauge Type	Any capacitance manometer transducer that requires ± 15 Vdc power at ± 250 mA and outputs 0-10 Vdc proportional to pressure.
Accuracy	0.01% of full-scale (as limited by display resolution).
Display Resolution	Highest 3 decades - 2 digits, lowest decade - 1 digit, scientific notation.
Pressure Range	1, 10, 100, 1000 Torr max heads, 4 decades of pressure.
Output to Head	± 15 V $\pm 2\%$ at 250 mA.
Input from Head	0-10 Vdc into 100 K ohm.
Analog Output	5 mA max.
Analog Output Speed	Limited by transducer speed.
Cable Connection	Cable termination is bare tinned wire, user terminates to transducer.

Service and Maintenance

7.1 Service Guidelines

Some minor difficulties are readily corrected in the field. Each module has fault indicator LEDs which help localize failures.

If a Qualified Service Person makes repairs at the component level, repairs properly made with equivalent electronic parts and rosin core solder do not void the warranty.

Because the 370 Controller contains static-sensitive electronic parts, the following precautions must be followed when troubleshooting:

- Use a grounded, conductive work surface. Wear a high impedance ground strap for personnel protection.
- Use conductive or static dissipative envelopes to store or ship static sensitive devices or printed circuit boards.
- Do not operate the product with static sensitive devices or other components removed from the product.
- Do not handle static sensitive devices more than absolutely necessary, and only when wearing a ground strap.
- Do not use an ohmmeter for troubleshooting MOS circuits. Rely on voltage measurements.
- Use a grounded, electrostatic discharge safe soldering iron.

NOTE: This product has been designed and tested to offer reasonably safe service provided it is installed, operated, and serviced in strict accordance with these safety instructions.



Danger, High Voltage – The high voltages present within the Power Supply are capable of causing injury or death. To avoid electric shock, wait 3 minutes after power is removed before touching any component within the Power Supply. This will permit charged capacitors to discharge.



The service and repair information in this manual is for the use of Qualified Service Personnel. To avoid shock, do not perform any procedures in this manual or perform any servicing on this product unless you are qualified to do so.



Do not substitute parts or modify instrument.

Because of the danger of introducing additional hazards, do not install substitute parts or perform any unauthorized modification to the product. Return the product to a service facility designated by G-P for service and repair to ensure that safety features are maintained. Do not use this product if it has unauthorized modifications.

7.2 Damage Requiring Service

Disconnect this product from the wall outlet and any other power sources, and refer servicing to Qualified Service Personnel if any the following conditions exist:

- The gauge cable, power-supply cord, or plug is damaged.
- Liquid has been spilled onto, or objects have fallen into, the product.
- The product has been exposed to rain or water.
- The product does not operate normally even if you have followed the Operation Instructions. Adjust only those controls that are covered in the instruction manual. Improper adjustment of other controls may result in damage and require extensive work by a qualified technician to restore the product to its normal operation.
- The product has been dropped or the enclosure has been damaged.
- The product exhibits a distinct change in performance. This may indicate a need for service.



Replacement Parts - When replacement parts are required, be certain to use the replacement parts that are specified by G-P, or that have the same characteristics as the original parts. Unauthorized substitutions may result in fire, electric shock or other hazards.



Safety Check - Upon completion of any service or repairs to this product, ask the Qualified Service Person to perform safety checks to determine that the product is in safe operating order.



Finite Lifetime - After ten years of normal use or even non-use, the electrical insulation in this product may become less effective at preventing electrical shock. Under certain environmental conditions which are beyond the manufacturer's control, some insulation material may deteriorate sooner. Therefore, periodically inspect all electrical insulation for cracks, crazing, or other signs of deterioration. Do not use if the electrical insulation has become unsafe.

Table 7-1 General Symptoms/Possible Causes

Symptom	Possible Cause
Unit will not power-up, no response to power switch.	Power fuse blown. Wrong line voltage selection, see Section 2.2 on page 2-15. Power interconnect cable improperly connected. See Figure 3-21 on page 3-22.
Power fuse blows repeatedly.	Wrong fuse rating. Wrong line voltage selection, see Section 2.2 on page 2-15.
Fault relay tripped.	Unplugged Convectron Gauge or sensor broken in Convectron Gauge. Collector input from IG unplugged. Convectron Gauge zero badly out of calibration. Bad table data in Convectron Option. Microprocessor reset occurring on a module (probable circuit failure). Checksum failure on process control board. (See Section 7.12 on page 7-11.) Cycle power and check all setpoints.

Symptom	Possible Cause
<p>IG will not turn on, or turns on briefly then shuts off.</p> <p>NOTE: Use Turn-off History, Section 7.11 on page 7-10 to aid in finding turn-off mechanisms.</p>	<p>IG at too high pressure.</p> <p>Display reads 99.9. Install the Memory Module (see Section 4.3.2 on page 4-5).</p> <p>Auto turn off circuit in Convectron Gauge module is shutting off IG.</p> <p>Pressure range setting wrong for pressure in gauge.</p> <p>Improper IG connector hookup.</p> <p>Badly contaminated IG.</p> <p>Damaged or contaminated filament coating, will not sustain emission.</p> <p>Try alternate filament.</p> <p>Short in IG cable.</p> <p>Short between IG electrodes.</p> <p>Open filament in IG. Try alternate filament.</p>
<p>Convectron Gauge display reads a fixed (non-changing) pressure.</p>	<p>IG AUTO switch is left in the SET position.</p> <p>A 99.9 display reading indicates a bad gauge.</p>
<p>Pressure reading is higher than expected.</p>	<p>IG contaminated.</p> <p>Low (L) pressure range is not selected appropriately (pressure is below 10^{-7} Torr).</p> <p>Interference from other ion source.</p> <p>Poor conductance in gauge's vacuum connection to chamber.</p> <p>Gas source in plumbing to gauge, such as leak or contamination.</p> <p>Chamber pressure high because of leak, contamination, or pump failure.</p> <p>Poor location selected for gauge.</p> <p>Faulty gauge or power cable.</p> <p>Faulty electrometer.</p>
<p>Degas will not turn on.</p>	<p>System pressure above 5×10^{-5} Torr.</p> <p>IG not turned on.</p>
<p>IG shuts off when degas is initiated.</p>	<p>Degas fuse blown.</p> <p>Badly contaminated IG.</p>
<p>IG pressure reads extremely low.</p>	<p>Collector unplugged.</p> <p>Bad collector cable.</p> <p>Collector coated with insulating material.</p> <p>Faulty electrometer.</p>
<p>IG pressure readout very erratic.</p>	<p>IG badly contaminated.</p> <p>Improper IG or Controller grounding.</p> <p>Bad collector cable.</p> <p>Excessive noise source.</p> <p>Interference from other charged particle source in chamber.</p> <p>Faulty electrometer.</p>
<p>Green +18 LED out on control board.</p>	<p>Improper connection of Power Supply cable.</p> <p>+18 volt supply to relays faulty.</p>
<p>Green +15 LED out.</p>	<p>+15 volt supply faulty (power to analog circuitry and RS-232).</p>

Symptom	Possible Cause
Green -15 LED out.	-15 volt supply faulty (power to analog circuitry and RS-232).
Green +5 display LED out.	+5 volt supply to display LED's faulty.
Green +5 logic LED out.	+5 volt logic supply faulty.

7.3 Fault Relay

When supplied with the available factory installed Stabil-Ion Remote Control (Cat. No. 370104), the 370 Control Unit is equipped with a "Fault" relay. The SPDT relay contacts are located on the remote output connector (See Figure 7-1). The relay is energized when no fault condition is detected. The relay is de-energized when:

- There is a fault condition detected by one of the microprocessors.
- There is a microprocessor failure causing the watchdog timer to reset.
- Power is lost due to Power Supply failure.
- Power is removed from the instrument.
- The power switch is turned off.

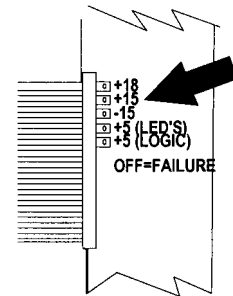

Figure 7-1 Control Board Top View Showing Green Power Indicator LED's

The source of the fault signal can be determined by observing the fault indicating red LED's and the Power Supply monitor's green LED's located beneath the Control Unit's cover (see Figure 1-8 on page 1-6). A list of specific causes are described in Table 7-2 on page 7-5.

Table 7-2 Fault Cause/Action

Cause	Action
Microprocessor reset occurring on some module (probable circuit failure).	Cycle power. Call Qualified Service Technician.
Unplugged Convectron Gauge.	Plug in gauge.
Sensor broken in Convectron Gauge.	Replace gauge.
Convectron Gauge zero badly out of calibration.	Adjust zero calibration. See Section 4.9 on page 4-29.
Checksum failure on Process Control board.	Cycle power and check all setpoints.
Checksum failure on Electrometer board.	Cycle power and check all settings.
Checksum failure on Process Control board.	Cycle power and check all setpoints.

7.4 Electrometer Minimum Calibration Adjustment

The Electrometer is automatically calibrated and does not require calibration.

The Electrometer is programmed to output 0.00 when the collector cable is damaged or unplugged, or when the collector current causes a pressure display lower than the minimum display as listed in Table 7-3.

Table 7-3 Pressure Minimums

Pressure Range	Minimum Display
H (100 μ A)	1.00 -9
L (4 mA)	2.00 -11
H UHV (100 μ A)	1.00 -10
L UHV (4 mA)	5.00 -12

The actual pressure limit for your gauge and Controller will be the x-ray current of the Stabil-Ion Gauge, which is 2×10^{-10} Torr for the Extended Range tube (370120), and 2×10^{-11} Torr for the UHV tube (370121).

7.5 Troubleshooting the Convectron Gauge Module

Table 7-4 Convectron Gauge Module Troubles.

Symptom	Possible Cause
Pressure reading grossly in error.	Controller out of calibration. Unknown gas type. Gauge not mounted horizontally (see Section 3.3 on page 3-3). Sensor damaged (e.g., by reactive gas). Gauge very dirty. Extremes of temperature or mechanical vibration.
CGA over current indicator lit.	Cable short, pins 1-3.
CGB over current indicator lit.	Cable short, pins 1-3.
Bridge circuit indicators lit.	Circuit failure.
CGA unplugged indicator lit.	CGA unplugged; open sensor wire.
CGB unplugged indicator lit.	CGB unplugged; open sensor wire.
Microprocessor reset LED lit or flashing.	Microprocessor failure.
A/D integration failure indicator lit or flashing.	Circuit failure.
Display reads blank.	Gauge unplugged; open sensor wire.

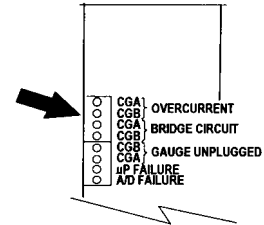

Figure 7-2 Convectron Module, Top View, Showing Trouble Indicator LED's

7.6 Convectron Gauge Test Procedure

The small diameter sensor wire can be damaged by small voltages. Do not perform electrical continuity tests with instruments applying in excess of 0.1 volt when the gauge is at vacuum, or 2 volts when at atmospheric pressure.

The Convectron Gauge should show the following resistances (pin numbers are embossed on the gauge base):

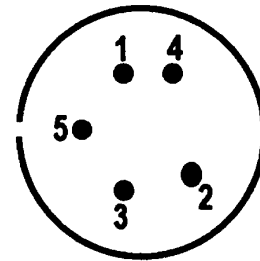

Table 7-5 Convectron Gauge Resistances

Pressure Range	Overpressure Point (Torr)
Pins 1 to 2	21 to 22 ohms
Pins 2 to 3	51 to 62 ohms
Pins 1 to 5	181 to 182 ohms

Figure 7-3 Convectron Gauge Base

If the resistance from pin 1 to pin 2 is about 800 ohms, the sensor wire is open.

7.7 Troubleshooting the Capacitance Manometer Module

Refer to Figure 7-4 for the location of the LEDs and potentiometers on the Capacitance Manometer module (pc board).

Table 7-6 Troubleshooting the Capacitance Manometer Module

Symptom	Possible Cause
Unstable reading	Mechanical vibration of the capacitance manometer, faulty system ground or cable ground.
Display always reads 0 (zero)	The capacitance manometer cable is unplugged, faulty cable, no $\pm 15V$ power.
LED #1 is Not Used	Not used
LED #2 is Illuminated	The Convectron gauge is unplugged.
LED #3 is Illuminated	A/D Failure. Defective A/D converter circuit
LED #4 is Not Used	Not used
LED #5 is Not Used	Not used
LED #6 is Illuminated	Defective PC board or Convectron bridge circuit.
LED #7 is Illuminated	Convectron overcurrent. Defective Convectron gauge or cable.
LED #8 is Illuminated	Microprocessor failure.

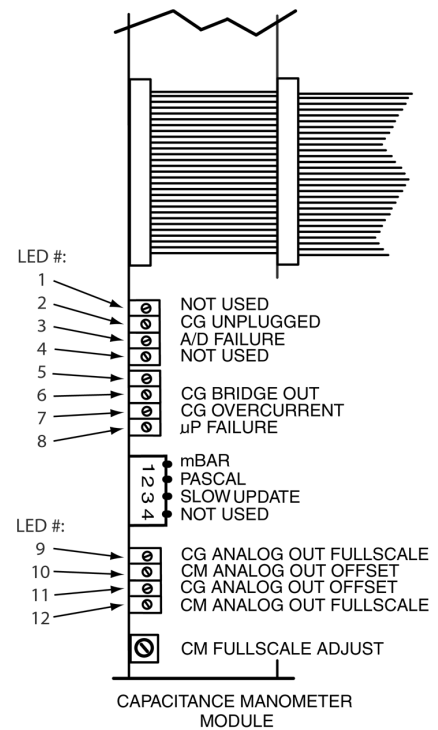

Figure 7-4 Capacitance Manometer Module

7.8 Cleaning Contaminated Convecatron Gauges



The fumes from solvents such as trichloroethylene, perchlorethylene, toluene, and acetone can be dangerous to health if inhaled. If used, use only in well-ventilated area exhausted to the outdoors. Acetone and toluene are highly flammable and should not be used near an open flame or energized electrical equipment.

The Convecatron Gauge may be baked to 150 °C nonoperating while under vacuum with the Connector removed.

All materials have been chosen for ultra high vacuum service, corrosion resistance, and bakeability. The envelope is type 304 stainless steel. All metallic joints in the envelope are TIG welded. No solder is used within the envelope. The following materials are exposed to the vacuum: Type 304 stainless steel, Carpenter Alloy 52, Kovar, Kapton, gold plated tungsten, borosilicate glass and Dow-Corning 9015 glass. The blue trim cover is rated at 150 °C.

When the small sensor wire is contaminated with oil or other films, its emissivity or its diameter may be appreciably altered and a change of calibration will result. Cleaning with trichloroethylene, perchloroethylene, toluene, or acetone is possible but it must be done very carefully so as not to damage the sensor.

Hold the gauge with the main body horizontal and the port projecting upward at an angle of 45°. Slowly fill it with solvent using a standard wash bottle with the spout inserted in the port to where it touches the screen. Let the solvent stand in the gauge for at least ten minutes. **Do not shake the gauge.** Shaking the gauge with liquid inside can damage the sensor wire. To drain the gauge, position it horizontally with the port facing downward. Slightly warming the gauge will help dry the gauge. Then allow the gauge to dry overnight with the port vertically downward and uncapped. Before reinstalling the gauge on the system, be certain no solvent odor remains.

7.9 Troubleshooting the Electrometer Module

If the Electrometer fails to operate, check the LCD display on the electrometer module for the error indications listed in Table 7-7.

Table 7-7 Electrometer Troubleshooting.

Symptom	Possible Cause
LCD display blank.	Display intensity needs adjustment.
μ p failure light blinks.	Electrometer module faulty.
IG shuts down.	Check cause of shutdown. See Section 7.11 on page 7-10, Turnoff History, for details.
IG displays 9.99 when gauge turn on is attempted.	Load the gauge module into the Controller via the data port. (Section 4.3.2 on page 4-5.)

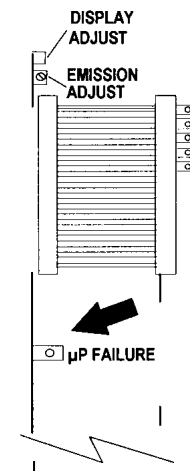

Figure 7-5 Electrometer Module, Top View Showing μ P Failure LED

7.10 Overpressure Shutdown

As pressure increases, the ion current to the collector increases until the high density of gas molecules begins to interfere with the ionization process. When some electrons cannot acquire sufficient energy to ionize the gas molecules, the collector current no longer increases with increasing pressure. This pressure is called the “turn around” pressure. Further pressure increases will result in a decreasing ion current.

The Stabil-Ion Controller is factory set so the ion gauge will shut down when the pressure rises above the overpressure setpoint pressures shown in Table 7-8.

Table 7-8 Overpressure Shutdown Settings.

Pressure Range	Overpressure Point (Torr)	%	Factory Setting
H	2×10^{-2}	100	✓
H	1×10^{-2}	50	
H	4×10^{-3}	20	
H	2×10^{-3}	10	
L	8×10^{-4}	100	✓
L	4×10^{-4}	50	
L	1.6×10^{-4}	20	
L	8×10^{-5}	10	

For reliable operation in general applications, the overpressure shutdown point is factory set below the Stabil-Ion Gauge turn around point at both emission currents. The overpressure shutdown can be readjusted for specific applications according to the following procedure.

The default factory setting for this function is 100%.

1. Press the ▼ arrow key until you see the setup menu.
2. Press the SELECT key to see the units display.
3. Press the ▼ key until you see the overpressure threshold display.
4. Press the SELECT key again so that the overpressure percent is flashing.
5. Press the ▲ or ▼ arrow keys to select the desired overpressure threshold percentage.
6. Press the SELECT key to store the new setting in memory.

Setup
Menu

UNITS
TORR

OVP. THLD
100%

OVP. THLD
100%

OVP. THLD
90%

OVP. THLD
90%

- Press CANCEL to return to the setup menu.
(Or press CANCEL again to return to the status display for the gauge tube that is turned on.)

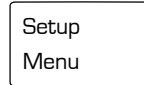

7.11 Turnoff History

In the event of an unplanned filament turnoff, the Turnoff History display provides an indication of what caused the Stabil-Ion Gauge to shut off.

- Press the ▼ arrow key until you see the information menu.
- Press the SELECT key to see the Serial IG #s display.
- Press the ▼ key until you see the Turnoff History display.
- Press the SELECT key to enter buffered data.
- There is a buffer of indications (Turnoff Displays) with the title Newest Event 0 marking the top or latest event in the buffer, and an Oldest Event # marking the oldest event (up to 33 events.) Event buffer # is from 0 – 33. (See the table below.)
- The buffer is reset with a power on reset and “Power On Start #” indicates when that occurred.
- Press the ▲ or ▼ arrow keys to see events from newest to oldest.

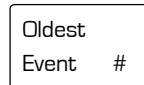
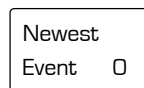
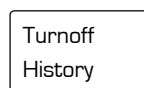
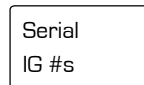
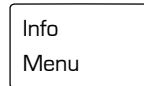

NOTE: All turnoff history is cleared when power is turned off. If you are trouble-shooting an IG turn-off problem, leave the power on, or record turnoff history before removing power.

Turn-Off Display	Source
	- Front panel IG turn off. - Computer interface IG off. - Convectron auto turn off. - Remote Input IG off.
	- Filament over current. - Grid over/under voltage.
	- Pressure exceeded the over pressure threshold.

7.12 Troubleshooting the Process Control Module

If the μ P FAILURE LED is lit or flashing (see Figure 7-6), there is a probable circuit failure. Return this product to a service facility designated by G-P for repair.

The setpoints are read from non-volatile memory into RAM when the unit powers up. On power up, a checksum is computed and stored in RAM, and is updated whenever a setpoint is changed. It is then periodically re-computed from the existing setpoints and checked against the pre-existing value. If for any reason (such as a power fluctuation or electrical transient in the system) a setpoint becomes corrupted, this method will trap the error. If this occurs the fault relay will be released if the Remote Input/Output Module is installed and will remain released until power is cycled on the 370 Control Unit.

If a setpoint is found to contain garbled data which cannot be interpreted as a valid setpoint, it will be set to 0, and the fault relay, if present, released.

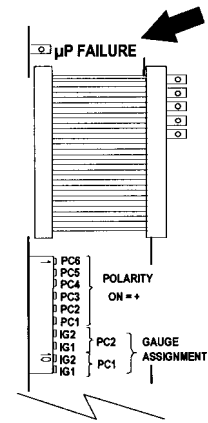

Figure 7-6 Process Control Module, Top View, Showing μ P Failure LED

7.13 RS-232 Troubleshooting

Because the RS-232 “standard” is found in a bewildering array of configurations, the first thing to do if trouble arises is check the following configuration options:

1. Check switch settings.

Be sure baud rate, character format and framing, and interface protocol are matched to your host computer or terminal's requirements. Note that there may be several mismatched parameters. Check to see if your computer requires the reversed-polarity RTS convention.

2. Check interface wiring.

The pin designations for the RS-232 connector are shown in Table 3-4 on page 3-14. Note that the “received” and “transmitted” data lines are defined as seen by the 370 Control Unit. Many companies supply “null modems” or switch boxes for the purpose of re-configuring the control lines for particular applications.

3. Check command format.

Be sure the strings you output to the 370 are in accord with the syntax defined in Section 4.16 on page 4-37.

Table 7-9 RS-232 Troubleshooting Guide

Symptom	Possible Cause
Micro-controller reset LED lit or flashing	Micro-controller failure
No response or garbled output	Baud rate incorrect. Character length incorrect or stop bit(s) incorrect. Bad cable.
OVERRUN ERROR message	Stop bit(s) incorrect, host software failure.
PARITY ERROR message	Parity incorrect.
SYNTAX ERROR message	Message to 370 not in accord with specified syntax. Could also result from failure to assert DCD handshake line.

7.14 RS-485 Troubleshooting

In the event of problems with the RS-485 communications verify the following items for proper configuration.

1. Check configuration switch settings.

Ensure the baud rate, character framing, and interface protocol are matched to the host computer or terminal's requirements. Note that there may be several mismatched parameters.

2. Check command format.

Ensure that the command strings output from the host computer or terminal to the Series 370 Controller are in accordance with the syntax defined by this addendum.

Table 7-10 RS-485 Troubleshooting Guide

Symptom	Possible Cause
Micro-controller reset LED CR1 illuminated or flashing	Micro-controller failure.
No response or garbled output	Baud rate incorrect, character length incorrect, character framing incorrect, or bias resistors do not exist or are incorrect.
Intermittently will not respond	Poor cable connections, ground fluctuations (the maximum common mode potential across the system is 7 volts) and EMI from other sources. Bias resistors do not exist or are incorrect. If the start character is not received properly, the Series 370 controller may not interpret it as a start character and the controller will not respond. Host software must be prepared to re-send a command if a response is not generated within a reasonable period of time.
OVERRUN ERROR message	Stop bit(s) incorrect, host software failure.
PARITY ERROR message	Parity incorrect.
SYNTAX ERROR message	Message to 370 Controller not in accord with specified syntax.

7.15 IEEE 488 Troubleshooting

If your interface fails to function, first verify the following:

1. Switch settings.

Be sure the vacuum system controller knows the address of the 370 as set by the dip switches. Be sure the vacuum system controller does not reserve certain addresses for system devices, e.g., a printer. Be sure the 370 is not in the talk-only mode unless desired for data logging. Be sure, if the SRQ mode is set, that your controller performs a serial poll in response to the SRQ from the 370.

2. Check interface wiring.

Be sure the cable is good; try swapping in a known good cable (IEEE 488 cables are available from Granville-Phillips). Check for too many devices on the bus or too great a total bus length (> 20 meters). Too many devices could cause problems due to capacitive loading.

3. Check command syntax.

Be sure you are following the syntax specified in Section 4.16 on page 4-37.

Table 7-11 IEEE 488 Troubleshooting Guide

Symptom	Possible Cause
Micro-controller reset LED lit	Micro-controller failure.
OVERRUN ERROR message	Host software failure.
SYNTAX ERROR message	Message to 370 not in accord with syntax.
No response	Incorrect address setting. Bad cable.

7.16 Field Installation of Modules

- 1.** Turn off power.
- 2.** With power off, remove any cables from the Control Unit rear panel.
- 3.** Observe antistatic precautions to avoid damaging static sensitive components inside the chassis. Use a grounded, conductive work surface. Do not handle MOS devices more than absolutely necessary, and only when wearing a high impedance ground strap. Use conductive envelopes to store or ship MOS devices or printed circuit boards. Do not operate the 370 Controller with MOS devices removed from the printed circuit boards.
- 4.** See Section 2.1.1 on page 2-2 for how to remove the top cover.
- 5.** Locate correct position for module.
- 6.** Carefully remove the bus ribbon cable from all modules located to the right (as you face the front panel) of the position where the module is to be installed. Remove connectors slowly using pull tabs.
- 7.** Lift out the filler module at the position where the module is to be installed.
- 8.** Install the module in its proper position making sure all ends lock together.
- 9.** Carefully reconnect the bus ribbon connectors.
- 10.** Select appropriate switch settings. See Chapter 2.
- 11.** Replace the top cover as directed in Section 2.1.7 on page 2-15.

7.17 Troubleshooting Flow Charts

Table 7-12 Troubleshooting Flow Charts

Fig. No.	Description	Fig. No.	Description
Figure 7-7	Power Turn On	Figure 7-10	Convectron Gauge Display
Figure 7-8	Stabil-Ion Gauge Turn On	Figure 7-11	RS-232/IEEE 488 Interface
Figure 7-9	Stabil-Ion Gauge Display		

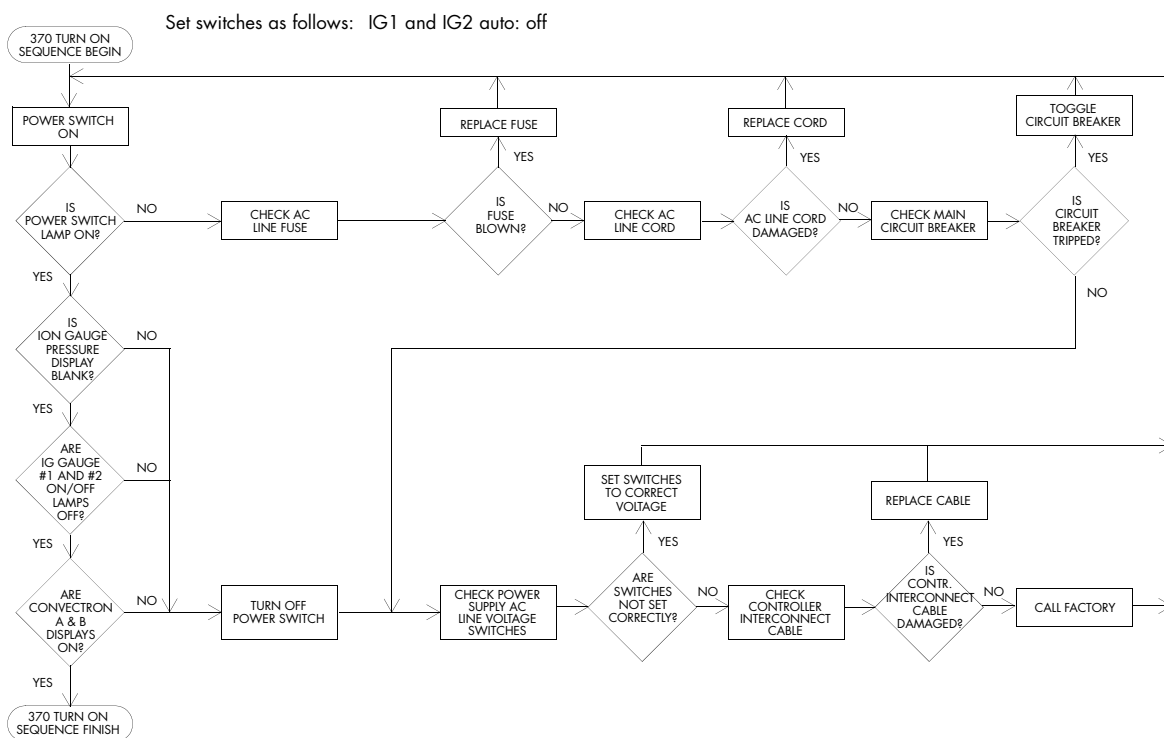

Figure 7-7 Power Turn On

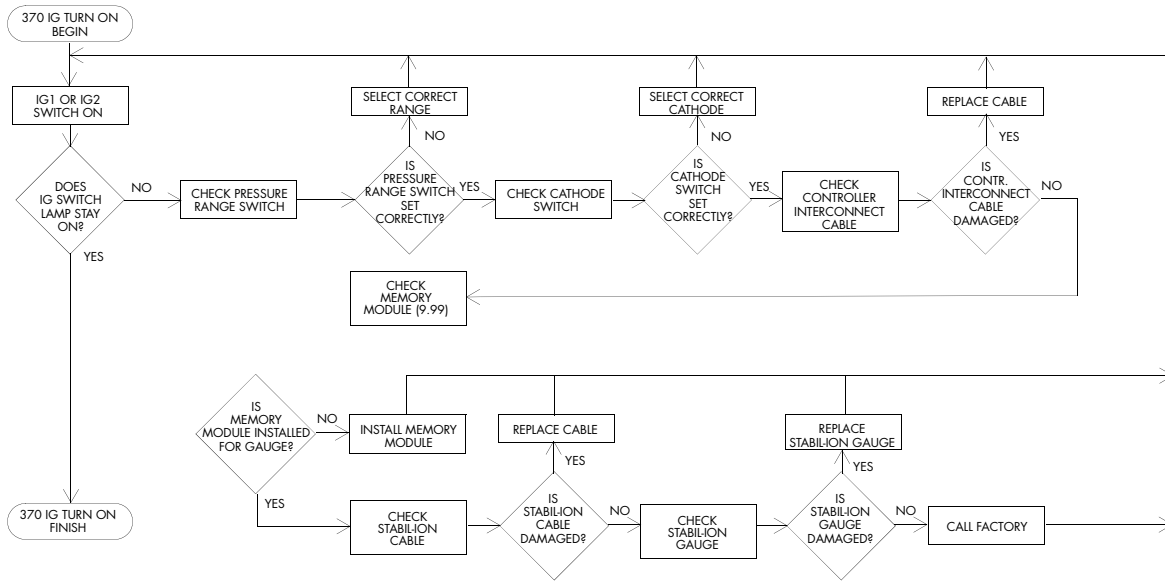

Figure 7-8 Stabil-Ion Gauge Turn On

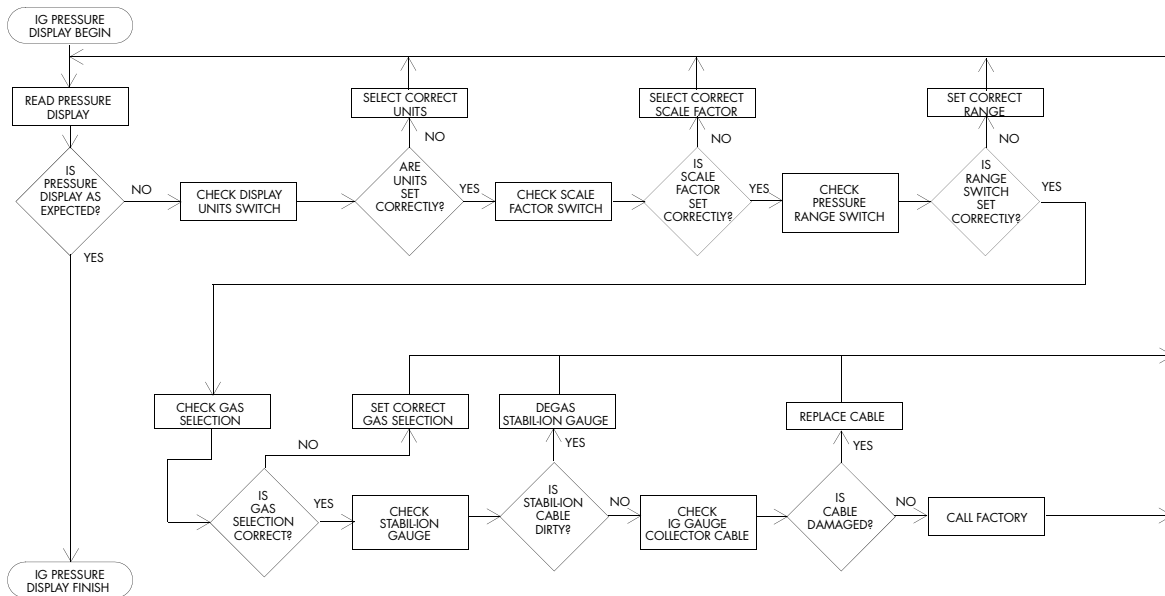

Figure 7-9 Stabil-Ion Gauge Display

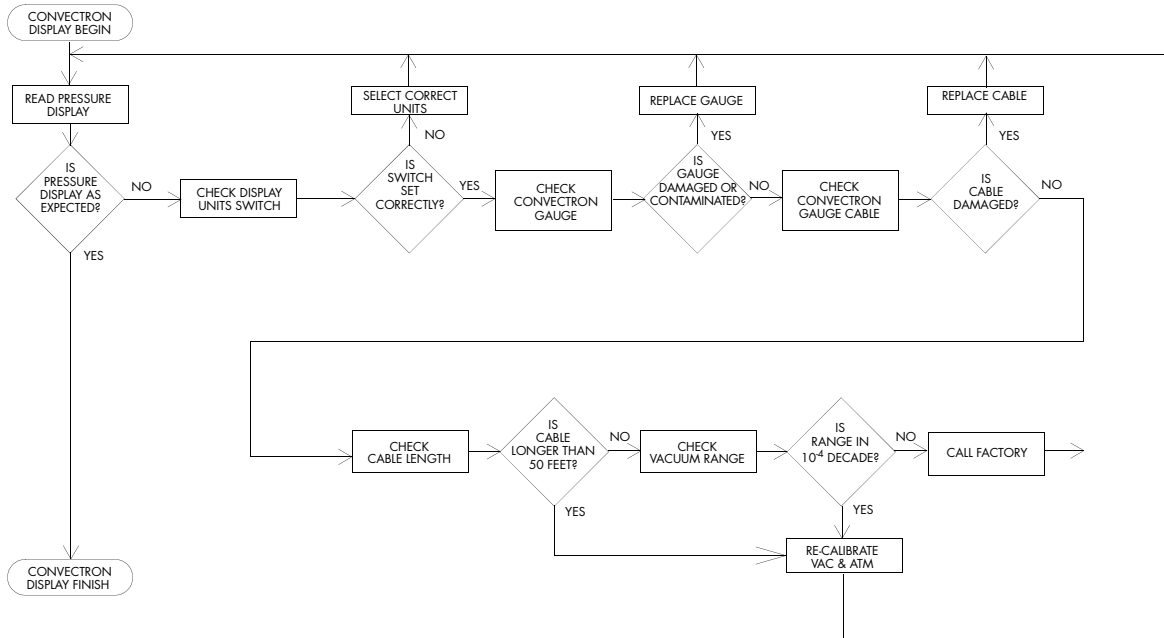

Figure 7-10 Convectron Gauge Display

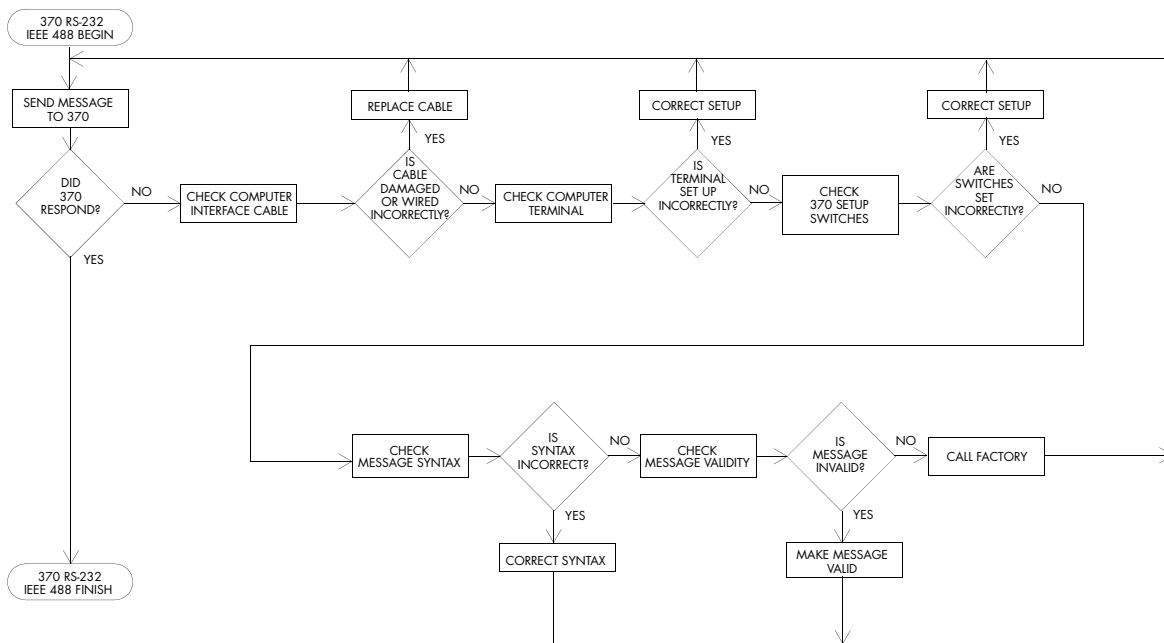

Figure 7-11 RS-232/IEEE 488 Interface

7.18 Service Form

Please photocopy this form, fill it out, and return it with your equipment:

RA No. _____ Contact Granville-Phillips Customer Service at **1-303-652-4400**,
or **1-800-776-6543 in the USA**; FAX: **1-303-652-2844** or
email: **co-csr@brooks.com**

Model No. _____ Serial No. _____ Date _____

Name _____ Phone No. _____

Company _____

Address _____

City _____ State _____ Zip _____

Please help Granville-Phillips continue to provide the best possible service by furnishing information that will help us determine the cause of the problem, as well as protect our analysis and calibration equipment from contamination.

Problem description: _____

Application description: _____

Has this product been used with high vapor pressure or hazardous materials? Yes No

If Yes, please list the types of gas, chemicals (common names, specific chemical,) biological materials, or other potentially contaminating or harmful materials exposed to the product during its use.

NOTE: PRODUCTS EXPOSED TO RADIOACTIVE MATERIAL CANNOT BE ACCEPTED BY GRANVILLE-PHILLIPS UNDER ANY CIRCUMSTANCES.

Corporate Officer signature: _____

Contact Name _____ Phone No. _____

A

- AC line voltage
 - Between 180V to 240V **2-16**
 - Between 90V to 130V **2-15**
- Analog output
 - Capacitance Manometer **3-8**
 - CONVECTRON Gauge
 - Connecting **3-7**
 - Signal **4-30**
 - STABIL-ION Gauge
 - Connecting **3-7**
 - Signal **4-17**

C

- Cable Installation
 - Capacitance Manometer **3-19**
 - CONVECTRON Gauge **3-18**
- Cable installation statement **3-1**
- Cable Intallation
 - STABIL-ION Gauge **3-19**
- Capacitance Manometer
 - Analog Output Signal **3-8, 4-33, 4-34**
 - Auto Turn On/Off **4-29**
 - Cable Installation **3-19**
 - Initial Transducer Calibration **4-32**
 - Operation **4-32**
 - Pressure Units Setup **2-3**
 - Specifications **6-5**
 - Theory of Operation **6-5**
- Certification, product **1-ix**
- Cleaning Contaminated Convector
 - Gauges **7-8**
- Command syntax
 - IEEE 488 **4-37**
 - RS-232 **4-37**
- Connector
 - STABIL-ION Gauge **3-20**
- Control Unit
 - Drawing **1-2, 1-4, 1-6**
 - Installing **3-5**
 - Removing top cover **2-2**
 - Set Up **2-1**
- CONVECTRON
 - Pressure units setup **2-3**

- CONVECTRON Gauge
 - Analog output - connecting **3-7**
 - Analog Output Signal **3-7, 4-30**
 - Auto Turn On/Off **4-29**
 - Cable Installation **3-18**
 - Cleaning **7-8**
 - Gas Types - Selecting **4-11**
 - Gases other than nitrogen or air **4-19**
 - IG auto turn on/off **4-28**
 - Installation **3-3**
 - Mounting **3-3**
 - Operation **4-18, 5-1**
 - Pressure measurement **4-18**
 - Pressure Units Setup **2-3**
 - Serial Number Display **4-43**
 - Specifications **6-4**
 - Test Procedure **7-6**
 - Theory of Operation **6-4**
 - Vacuum connections **3-4**
 - Zero and Atmospheric Indications **4-29**

- CONVECTRON Gauge Module
 - illustration **4-29, 4-32, 4-33**
 - Troubleshooting **7-6**
- Convector/Capacitance Manometer
 - Analog Output Signal **4-34**

D

- DA-26P Connector **3-11**
- Damage Requiring Service **7-2**
- Damage requiring service
 - safety **1-vi**
- Degas
 - Power limiter **4-17**
 - Pressure indication during **4-17**
- degas Ionization gauge **5-2**
- Degas Time **4-12**
- Degassing
 - Bayard-Alpert Gauges **6-3**
- Degassing the Stabil-Ion Gauge **4-15**
- Display formats **5-1**
- Drawings
 - Control Unit
 - Front panel **1-2, 1-3**
 - Rear panel **1-4**
 - Top view **1-6**
 - Power Supply **1-5**
 - Six channel Process Control **2-5**
 - STABIL-ION Gauge **3-21**
 - Two channel Process Control **2-5**

E

- EMC compliance **3-1**
- Environmental conditions **3-2**

F

- FCC verification **1-x**
- Field Installation of Modules **7-13**
- Filament **4-8**
- Filament Selection
 - STABIL-ION Gauge **4-8**
- Filaments (Cathodes) used in Bayard-Alpert Gauges **6-2**
- Flow Charts
 - Troubleshooting **7-14**

G

- Gas Types - Selecting
 - CONVECTRON Gauge **4-11**
 - STABIL-ION Gauge **4-10**
- Gases other than nitrogen or air **4-9, 4-19**
- Grounding the system **3-5**
- Guard **3-20**

I

- IEEE 488
 - Bus address **2-14**
 - Command syntax **4-37**
 - Computer interface setup **2-14**
 - Computer Interface-connecting **3-18**
 - Preparing for use **4-37**
 - SRQ mode **2-15**
 - Talk-only mode **2-14**
 - Troubleshooting **7-12**
- IG Process Control channel switch
 - settings **2-6**
- Installation **3-1**
 - CONVECTRON Gauge **3-3**
 - Grounding the system **3-5**
 - STABIL-ION Gauge **3-2**
 - Tips **3-1**

L

- Line Frequency **4-14**

M

- Memory Module
 - STABIL-ION Gauge **4-5**
- Memory Module - Loading **4-2**
- Modules
 - Field Installation **7-13**
- Mounting
 - Control Unit and Power Supply **3-6**
 - CONVECTRON Gauge **3-3**
 - Hardware for **1-2**
 - Power Supply **3-5**

O

- Operation
 - CONVECTRON Gauge **4-18, 5-2**
 - STABIL-ION Gauge **4-1**
 - STABIL-ION System **5-1, 6-1**
- Overpressure Shutdown **7-9**
- Overpressure Threshold **4-13**

P

- Power cables
 - Connecting **3-22**
- Power Supply
 - Mounting **3-5**
 - Set Up **2-15**
- Preparing for Pressure Measurement **4-1**
- Pressure Display Update Speed **4-14**
- Pressure measurement
 - CONVECTRON Gauge **4-18**
 - STABIL-ION Gauge **4-1**
- Pressure range **4-7**
- Pressure Units
 - Capacitance Manometer - Setup **2-3**
 - CONVECTRON Gauge - Setup **2-3**
 - CONVECTRON setup **2-3**
 - Display formats **5-1**
 - STABIL-ION Gauge - Setup **4-2**
- Process Control
 - Connecting relays **3-8**
 - Preparation for Operation **4-35**
 - Setpoint display and adjustment **4-35**
 - Setup **2-4**
 - Tips **2-7**
- Process Control Module
 - Troubleshooting **7-11**

R

- Relay polarity setting **2-7, 2-13**
- Remote Control
 - IG on/off **3-12**
 - Input states **3-10**
 - output connector **3-13**
 - Pressure range **3-12**
 - STABIL-ION Gauge **3-9**
- RS-232
 - Baud Rate **2-8**
 - Byte format **2-8**
 - Character Framing **2-9**
 - Command syntax **4-37**
 - Computer interface setup **2-8**
 - Computer Interface-connecting **3-13**
 - Handshaking **2-10**
 - Preparing for use **4-36**
 - Talk-Only Mode **2-9**
 - Troubleshooting **7-11**
- RS-485
 - Address **2-12**
 - Baud Rate **2-13**
 - Byte Format **2-13**
 - Character Framing **2-13**
 - Character framing switch settings **2-13**
 - Computer Interface Setup **2-12**
 - Computer Interface-connecting **3-16**
 - Factory defaults **2-12**
 - Troubleshooting **7-12**

S

- Safety
 - damage requiring service **1-vi**
 - instructions **1-v**
- Scale factor **4-9**
- Selecting Gas Type for the
 - Convectron Gauge **4-11**
- Selecting Gas Type for the Stabil-Ion
 - Gauge **4-10**
- Service and Maintenance **7-1**
- Service Form **7-17**
- Service form **7-17**
- Service guidelines **1-ix, 7-1**
- Setpoint display and adjustment
 - Process Control **4-35**
- Setup Menu Variables **4-12**

Specifications

- Capacitance Manometer **6-5**
- CONVECTRON Gauge **6-4**
- STABIL-ION Gauge **6-3**
- STABIL-ION
 - Gases other than nitrogen or air **4-9**
- STABIL-ION Gauge
 - Alternate On/Off **4-15**
 - Analog output - connecting **3-7**
 - Analog output signal **3-7, 4-17**
 - Auto turn On/Off **4-28**
 - Bakeout **4-17**
 - Cable Installation **3-19**
 - Cables **3-19**
 - Calibration Memory **4-1**
 - Connector **3-1, 3-20**
 - Degassing **4-15**
 - Filament Selection **4-8**
 - Gas Types - Selecting **4-10**
 - Guard **3-20**
 - Installation **3-2**
 - Memory Module **4-1, 4-5**
 - Operation **4-1**
 - Picture **1-1**
 - Pressure measurement **4-1**
 - Pressure range settings **4-7**
 - Remote Control **3-9**
 - Serial Number Display **4-41**
 - Specifications **6-3**
 - Theory of Operation **6-1**
 - Turn On **4-15**
- STABIL-ION System
 - Operation **5-1, 6-1**

T

- Theory of Operation
 - Capacitance Manometer **6-5**
 - CONVECTRON Gauge **6-4**
 - STABIL-ION Gauge **6-1**
- Tips
 - Installation **3-1**
 - Process Control **2-7**
- Top cover
 - Removing **2-2**

Troubleshooting

Capacitance Manometer Module

7-7

CONVECTRON Gauge Module

7-6

Electrometer Module

7-8

Flow Charts

7-14

IEEE 488

7-12

Process Control Module

7-11

RS-232

7-11

RS-485

7-12

Tables

7-2

Turnoff History

7-10

U

Units of Measure

4-12

Using the Remote Inputs

3-12

V

Vacuum connections

3-4

W

Warranty

1-ix

X

X Ray Limit of Bayard-Alpert Gauges

6-2

Series 370

Granville-Phillips Series 370 Stabil-Ion® Vacuum Measurement Controller



6450 Dry Creek Parkway

Longmont, CO USA 80503
Phone: 1-303-652-4400

15 Elizabeth Drive

Chelmsford, MA USA 01824
Phone: 1-978-262-2400

Worldwide Customer Service/Support - 27/7
Phone: 1-800-367-4887

To obtain a copy of this instruction manual online,
visit our website at www.brooks.com
(Adobe® Reader® version 5.0 or higher required)
© 2006, 2007, Brooks Automation, Inc.

Instruction Manual

Instruction manual part number 370119

Revision 05 - November 2007