

**SHARP**®

MODEL: MX-2300N  
MX-2700N

# User's Guide

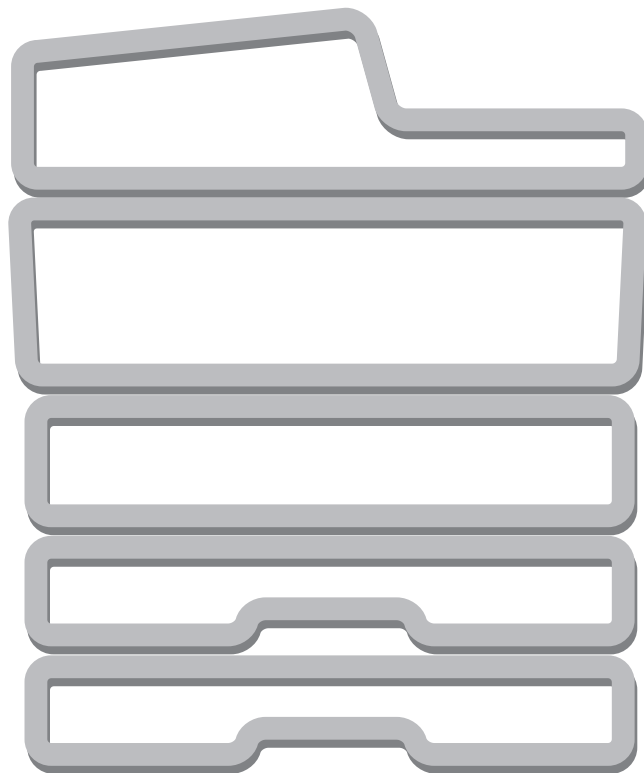

---

---

# TABLE OF CONTENTS

<b>ABOUT THIS MANUAL</b> .....	<b>2</b>
• MANUALS PROVIDED WITH THE MACHINE	2

## **1 BEFORE USING THE MACHINE**

<b>PART NAMES AND FUNCTIONS</b> .....	<b>4</b>
• EXTERIOR .....	4
• INTERIOR .....	6
• AUTOMATIC DOCUMENT FEEDER .....	7
• CONNECTORS .....	8
• OPERATION PANEL .....	9
<b>TOUCH PANEL</b> .....	<b>11</b>
<b>PRINT/SEND STATUS (JOB STATUS)</b> .....	<b>12</b>
<b>TURNING THE POWER ON AND OFF</b> .....	<b>13</b>
• ENERGY SAVE FUNCTIONS .....	14
• [POWER SAVE] KEY .....	14
<b>USER AUTHENTICATION</b> .....	<b>15</b>
• AUTHENTICATION BY USER NUMBER .....	15
• AUTHENTICATION BY LOGIN NAME / PASSWORD .....	17

## **2 LOADING PAPER**

<b>IMPORTANT POINTS ABOUT PAPER</b> .....	<b>20</b>
• NAMES AND LOCATIONS OF TRAYS .....	20
• THE MEANING OF "R" IN PAPER SIZES .....	21
• USEABLE PAPER .....	21
<b>TRAY SETTINGS FOR TRAYS 1 TO 4</b> .....	<b>23</b>
• LOADING PAPER .....	23
• CHANGING THE PAPER SIZE .....	24
<b>LOADING PAPER IN TRAY 5 (Large capacity tray)</b> .....	<b>26</b>
<b>LOADING PAPER IN THE BYPASS TRAY</b> .....	<b>28</b>
• IMPORTANT POINTS WHEN USING THE BYPASS TRAY .....	30

## **3 ORIGINALS**

<b>PLACING THE ORIGINAL</b> .....	<b>33</b>
• PLACING ORIGINALS IN THE AUTOMATIC DOCUMENT FEEDER .....	33
• PLACING THE ORIGINAL ON THE DOCUMENT GLASS .....	36

## **4 PERIPHERAL DEVICES**

<b>PERIPHERAL DEVICES</b> .....	<b>38</b>
<b>FINISHER</b> .....	<b>40</b>
• PART NAMES .....	40
• SUPPLIES .....	40
• FINISHER MAINTENANCE .....	41
<b>SADDLE STITCH FINISHER</b> .....	<b>45</b>
• PART NAMES .....	45
• SUPPLIES .....	45
• SADDLE STITCH FINISHER MAINTENANCE	46

## **5 MAINTENANCE**

<b>REGULAR MAINTENANCE</b> .....	<b>52</b>
• CLEANING THE DOCUMENT GLASS AND AUTOMATIC DOCUMENT FEEDER .....	52
• CLEANING THE MAIN CHARGER OF THE PHOTOCONDUCTIVE DRUM .....	53
• CLEANING THE BYPASS FEED ROLLER .....	53
• CLEANING THE ORIGINAL FEED ROLLER .....	53
• CLEANING THE LASER UNIT .....	54
<b>REPLACING THE TONER CARTRIDGES</b> .....	<b>58</b>
<b>REPLACING THE WASTE TONER BOX</b> .....	<b>61</b>

## **6 ENTERING TEXT**

<b>FUNCTIONS OF THE MAIN KEYS</b> .....	<b>64</b>
• CHANGING THE ENTRY MODE .....	65
• ENTERING TEXT FROM AN EXTERNAL KEYBOARD .....	65

---

---

# ABOUT THIS MANUAL

## Please note

---

- Considerable care has been taken in preparing this manual. If you have any comments or concerns about the manual, please contact your dealer or nearest SHARP Service Department.
- This product has undergone strict quality control and inspection procedures. In the unlikely event that a defect or other problem is discovered, please contact your dealer or nearest SHARP Service Department.
- Aside from instances provided for by law, SHARP is not responsible for failures occurring during the use of the product or its options, or failures due to incorrect operation of the product and its options, or other failures, or for any damage that occurs due to use of the product.

## Warning

---

- Reproduction, adaptation or translation of the contents of manual without prior written permission is prohibited, except as allowed under copyright laws.
- All information in this manual is subject to change without notice.

## Illustrations and the operation panel and touch panel shown in this manual

---

The peripheral devices are generally optional, however, some models include certain peripheral devices as standard equipment. The explanations in this manual assume that a right tray and stand/2 x 500 sheet paper drawer are installed.

To further explain certain functions and uses, some explanations assume that additional peripheral devices are installed.

The display screens, messages, and key names shown in the manual may differ from those on the actual machine due to product improvements and modifications.

# MANUALS PROVIDED WITH THE MACHINE

Printed manuals and manuals stored in PDF format on the machine's hard drive are provided with the machine. When using the machine, read the appropriate manual for the feature you are using.

## Printed manuals

Manual name	Contents
<b>Safety Guide</b>	This manual contains instructions for using the machine safely and lists the specifications of the machine and its peripheral devices.
<b>Software Setup Guide</b>	This manual explains how to install the software and configure settings to use the machine as a printer or scanner.
<b>Quick Start Guide</b>	This manual provides easy-to-understand explanations of all the functions of the machine in a single volume. Detailed explanations of each of the functions can be found in the manuals in PDF format.
<b>Troubleshooting</b>	This manual explains how to remove paper misfeeds and provides answers to frequently asked questions regarding the operation of the machine in each mode. Refer to this manual when you have difficulty using the machine.
<b>Facsimile Quick Reference Guide</b>	This manual explains the basic procedures for using the fax function of the machine, and provides an overview of the features of the fax function, troubleshooting procedures, and specifications. For detailed information on using the fax function and the system settings for fax, see the "Facsimile Guide" in PDF format.



## Operation manuals in PDF format





The manuals in PDF format provide detailed explanations of the procedures for using the machine in each mode. To view the PDF manuals, download them from the hard drive in the machine. The procedure for downloading the manuals is explained in "How to download the manuals in PDF format" in the Quick Start Guide.

Manual name	Contents
<b>User's Guide (This manual)</b>	This manual provides information, such as basic operation procedures, how to load paper, and machine maintenance.
<b>Copier Guide</b>	This manual provides detailed explanations of the procedures for using copy function.
<b>Printer Guide</b>	This manual provides detailed explanations of the procedures for using print function.
<b>Facsimile Guide</b>	This manual provides detailed explanations of the procedures for using fax function and the "System Settings" that are related to fax.
<b>Scanner Guide</b>	This manual provides detailed explanations of the procedures for using scan function and Internet Fax function.
<b>Document Filing Guide</b>	This manual provides detailed explanations of the procedures for using the document filing function. The document filing function allows you to save the document data of a copy or fax job, or the data of a print job, as a file on the machine's hard disk. The file can be called up as needed.
<b>System Settings Guide</b>	This manual explains the "System Settings", which are used to configure a variety of parameters to suit the aims and the needs of your workplace. Current settings can be displayed or printed out from the System Settings.

## Icons used in the manuals

The icons in the manuals indicate the following types of information:

 <b>Warning</b>	This alerts you to a situation where there is a risk of human death or injury.
 <b>Caution</b>	This alerts you to a situation where there is a risk of human injury or property damage.

	This alerts you to a situation where there is a risk of machine damage or failure.		This indicates the name of a system setting and a provides a brief explanation of the setting. For detailed information on each system setting, see the System Settings Guide. <b>When "System Settings:" appears:</b> A general setting is explained. <b>When "System Settings (Administrator):" appears:</b> A setting that can only be configured by an administrator is explained.
	This provides a supplemental explanation of a function or procedure.		
	This explains how to cancel or correct an operation.		

# 1

# BEFORE USING THE MACHINE

This chapter provides basic information about the machine. Please read this chapter before using the machine.

## PART NAMES AND FUNCTIONS

### EXTERIOR

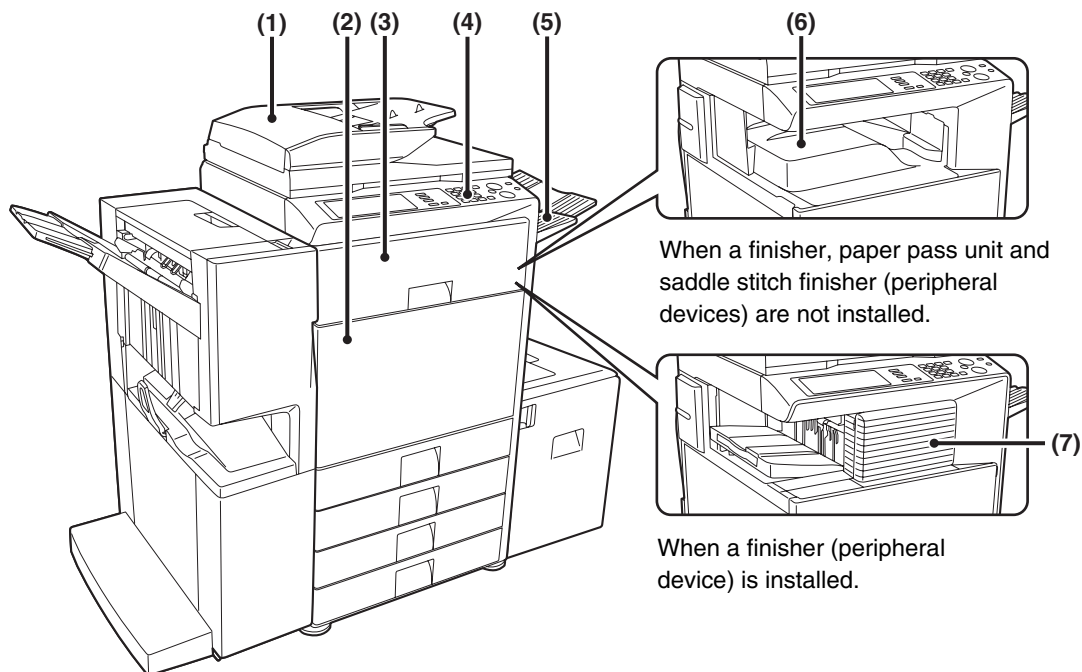

**(1) Reversing single pass feeder  
(automatic document feeder)**

This automatically feeds and scans multiple originals. Both sides of two-sided originals can be automatically scanned.  
➤ [PLACING THE ORIGINAL](#) (page 33)

**(2) Front cover**

Open this cover to switch the main power switch to "On" or "Off" or to replace a toner cartridge.  
➤ [TURNING THE POWER ON AND OFF](#) (page 13)  
➤ [REPLACING THE TONER CARTRIDGES](#) (page 58)

**(3) Paper pass unit\***

This transfers output to the saddle stitch finisher.

**(4) Operation panel**

This is used to select functions and enter the number of copies.  
➤ [OPERATION PANEL](#) (page 9)

**(5) Exit tray unit (right tray)\***

When installed, output can be delivered to this tray.

**(6) Output tray (center tray)**

Copy jobs and print jobs are delivered to this tray.

**(7) Finisher\***

This can be used to staple output. A punch module can also be installed to punch holes in output.  
➤ [FINISHER](#) (page 40)



\* Peripheral Devices

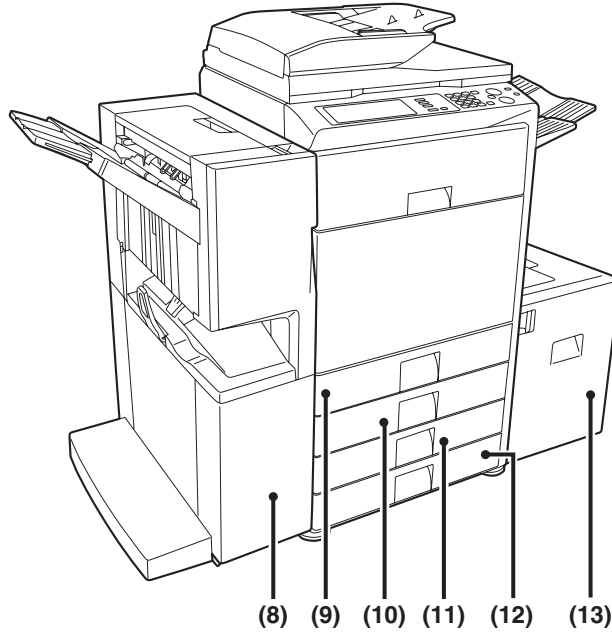

**(8) Saddle stitch finisher\***

This can be used to staple output. The saddle stitch finisher can automatically staple output at the center line and fold the pages to create a pamphlet. A punch module can also be installed to punch holes in output.

➤ [SADDLE STITCH FINISHER](#) (page 45)

**(9) Tray 1**

This holds paper. Up to 500 sheets of paper can be loaded.

➤ [TRAY SETTINGS FOR TRAYS 1 TO 4](#) (page 23)

**(10) Tray 2**

This holds paper. Up to 500 sheets of paper can be loaded.

➤ [TRAY SETTINGS FOR TRAYS 1 TO 4](#) (page 23)

**(11) Tray 3 (when a stand/1 x 500 sheet paper drawer or a stand/2 x 500 sheet paper drawer is installed)\***

This holds paper. Up to 500 sheets of paper can be loaded.

➤ [TRAY SETTINGS FOR TRAYS 1 TO 4](#) (page 23)

**(12) Tray 4 (when a stand/2 x 500 sheet paper drawer is installed)\***

This holds paper. Up to 500 sheets of paper can be loaded.

➤ [TRAY SETTINGS FOR TRAYS 1 TO 4](#) (page 23)

**(13) Tray 5 (when a large capacity tray is installed)\***

This holds paper. Up to 3500 sheets of paper can be loaded.

➤ [LOADING PAPER IN TRAY 5 \(Large capacity tray\)](#) (page 26)



\* Peripheral Devices

# INTERIOR

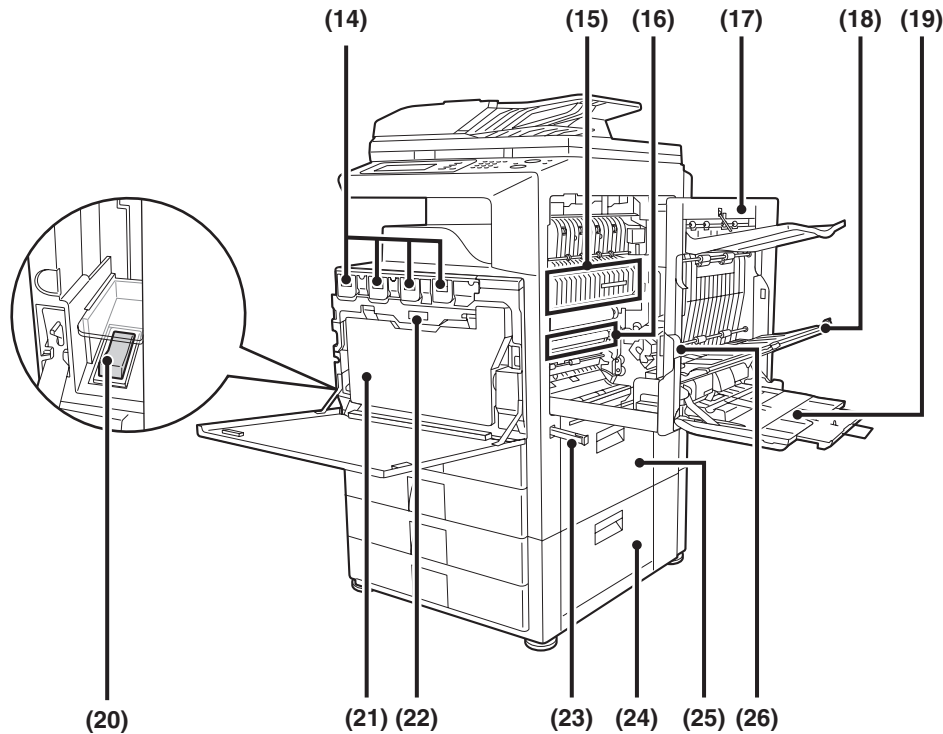

## (14) Toner cartridges

When the toner in a cartridge runs out, the cartridge must be replaced with a new cartridge of the same color.

➤ [REPLACING THE TONER CARTRIDGES](#) (page 58)

## (15) Fusing area

Heat is applied here to fuse the transferred image onto the paper.

### **Caution**

**The fusing unit is hot. Take care not to burn yourself when removing a paper misfeed.**

## (16) Transfer belt

During full color copying, the toner images of each of the four colors on each of the photoconductive drums are combined together on the transfer belt.

During black and white copying, only the black toner image is transferred onto the transfer belt.

 Do not touch or damage the transfer belt. This may cause a defective image.

## (17) Right side cover

Open this cover to operate the fusing area pressure adjustment lever and to remove a misfeed.

➤ [Fusing unit pressure adjusting levers](#) (page 32)

## (18) Paper reversing section cover

This is used when 2-sided copying and printing is performed. Open this cover to remove a paper misfeed.

## (19) Bypass tray

Use this tray to feed paper manually. When loading paper larger than 8-1/2" x 11"R or A4R, be sure to pull out the bypass tray extension.

➤ [LOADING PAPER IN THE BYPASS TRAY](#) (page 28)

## (20) Main power switch

This is used to power on the machine.

When using the fax or Internet fax functions, keep this switch in the "On" position.

➤ [TURNING THE POWER ON AND OFF](#) (page 13)

## (21) Waste toner box

This collects excess toner that remains after copying and printing.



Your service technician will collect the waste toner box.

## (22) Waste toner box release button

Press this button when you need to release the waste toner box lock to replace the waste toner box or clean the laser unit.

➤ [CLEANING THE LASER UNIT](#) (page 54)

➤ [REPLACING THE WASTE TONER BOX](#) (page 61)

## (23) Handle

Pull this out and grasp it when moving the machine.

## (24) Right cover of stand/1 x 500 sheet paper drawer Right cover of stand/2 x 500 sheet paper drawer (when a stand/1 x 500 sheet paper drawer or a stand/2 x 500 sheet paper drawer is installed)

Open this to remove a paper misfeed in tray 3 or tray 4.

## (25) Paper tray right side cover

Open this to remove a paper misfeed in tray 1 or tray 2.

## (26) Right side cover release lever

To remove a paper jam, pull and hold this knob up to open the right side cover.

# AUTOMATIC DOCUMENT FEEDER

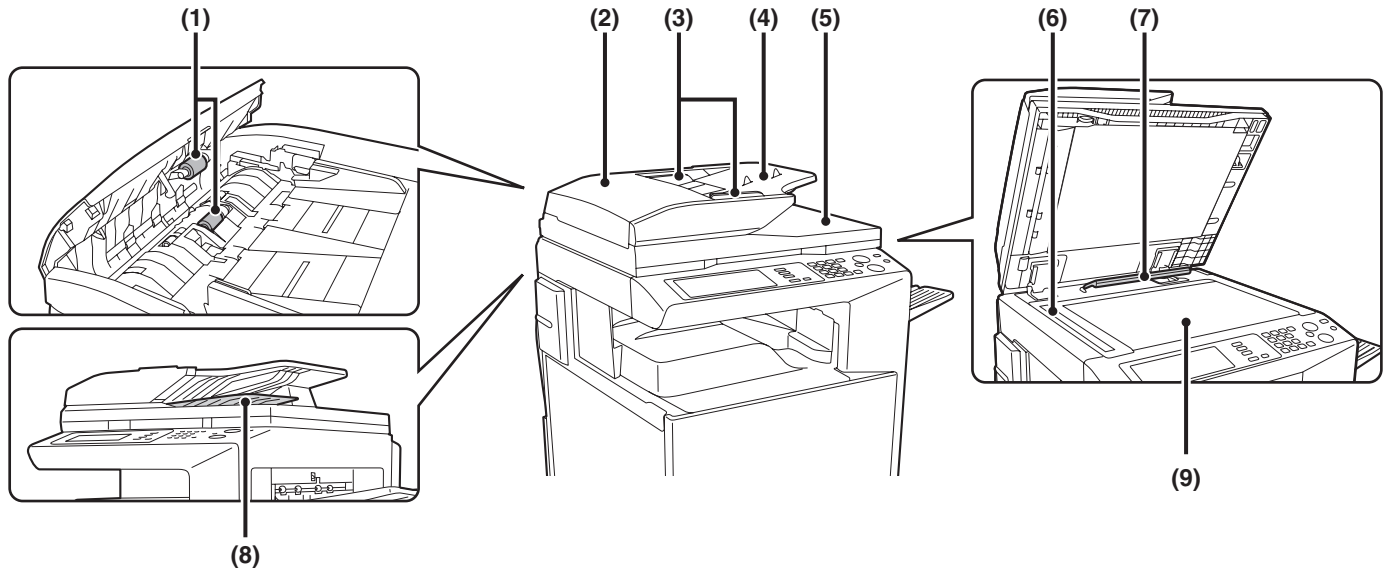

**(1) Paper feed roller**

This roller rotates to automatically feed the original.

**(2) Document feeding area cover**

Open this cover to remove an original misfeed or clean the paper feed roller.

**(3) Original guides**

These help ensure that the original is scanned correctly. Adjust the guides to the width of the original.  
☞ [PLACING THE ORIGINAL](#) (page 33)

**(4) Document feeder tray**

Place originals in this tray. 1-sided originals must be placed face up.  
☞ [PLACING THE ORIGINAL](#) (page 33)

**(5) Original exit tray**

Originals are delivered to this tray after scanning.

**(6) Scanning area**

Originals placed in the document feeder tray are scanned here.  
☞ [REGULAR MAINTENANCE](#) (page 52)

**(7) Original size detector**

This detects the size of an original placed on the document glass.

☞ [PLACING THE ORIGINAL ON THE DOCUMENT GLASS](#) (page 36)

**(8) Reversing tray**

During scanning of a 2-sided original, the original is temporarily output to this tray in order to be turned over for scanning of the reverse side.

**(9) Document glass**

Use this to scan a book or other thick original that cannot be fed through the automatic document feeder.  
☞ [PLACING THE ORIGINAL ON THE DOCUMENT GLASS](#) (page 36)



# CONNECTORS

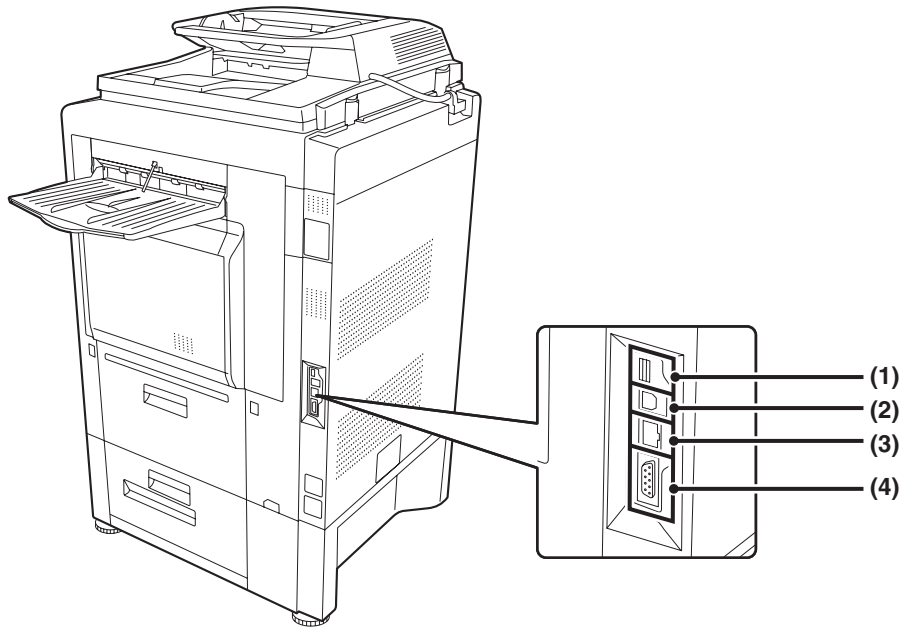

**(1) USB connector (A type)**

This is used to connect a USB hub or USB memory device to the machine.  
For the USB cable, use a shielded type cable.

**(2) USB connector (B type )**

A computer can be connected to this connector to use the machine as a printer.  
For the USB cable, use a shielded type cable.

**(3) LAN connector**

Connect the LAN cable to this connector when the machine is used on a network.  
For the LAN cable, use a shielded type cable.

**(4) Service-only connector**

**⚠ Caution**

Connecting a cable to this connector may cause the machine to malfunction.

**Important note for service technicians:**  
The cable connected to the service connector must be less than 118" (3 m) in length.

# OPERATION PANEL

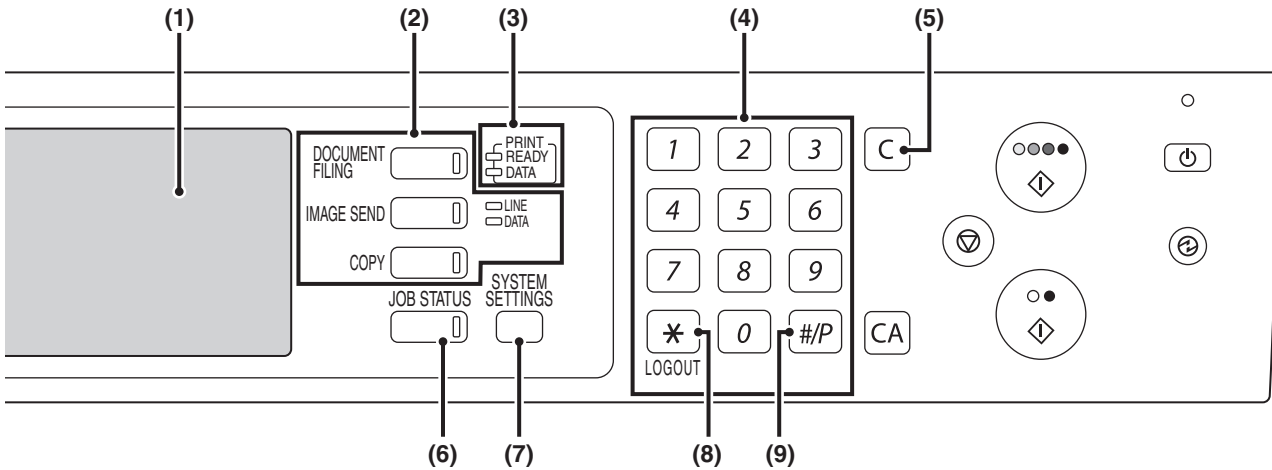

## (1) Touch panel

Messages and keys appear in the touch panel display. Touch the displayed keys to perform a variety of operations. When a key is touched, a beep sounds and the selected item is highlighted. This provides confirmation as you perform an operation.

☞ [TOUCH PANEL](#) (page 11)

## (2) Mode select keys and indicators

Use these keys to change the mode displayed in the touch panel. The indicator of a key lights when the key is selected.

### [DOCUMENT FILING] key

Press this key to switch to document filing mode when you wish to store a document as an image file on the hard drive or print or transmit an image stored on the hard drive.

☞ Document Filing Guide

### [IMAGE SEND] key

Press this key to select network scanner / fax mode to use the scanner function or fax function.

☞ Facsimile Guide

☞ Scanner Guide

#### • LINE indicator

This lights up during transmission or reception in fax or Internet fax, and during transmission in scan.

#### • DATA indicator

This lights up during reception in fax or Internet fax mode. This blinks when a received fax cannot be printed because of a problem such as out of paper.

This lights up when an image is being sent in scan mode.

### [COPY] key

Press this key to select copy mode. Hold the [COPY] key down to view the machine's total page use count and amount of toner remaining.

☞ Copier Guide

## (3) PRINT mode indicators (READY indicator / DATA indicator)

### • READY indicator

Print data can be received when this indicator is lit.

### • DATA indicator

This blinks while print data is being received and lights steadily while printing is taking place.

## (4) Numeric keys

These are used to enter the number of copies and fax numbers.

## (5) [CLEAR] key (C)

Press this key to return the number of copies to "0".

## (6) [JOB STATUS] key

Press this key to display the job status screen. The job status screen is used to check information on jobs and cancel jobs.

The indicator in the key lights up when the job status screen is displayed.

☞ [PRINT/SEND STATUS \(JOB STATUS\)](#) (page 12)

## (7) [SYSTEM SETTINGS] key

Press this key to display the system settings menu screen. The system settings can be adjusted to make the machine easier to use, such as configuring paper tray settings and storing addresses.

☞ System Settings Guide

## (8) [LOGOUT] key (\*)

Press this key to log out after you have logged in and used the machine. When using the fax function, this key can also be pressed to send tone signals on a pulse dial line.

☞ [USER AUTHENTICATION](#) (page 15)

## (9) [PROGRAM] key (#/P)

Press this key to use a job program when using the copy function or the fax function.

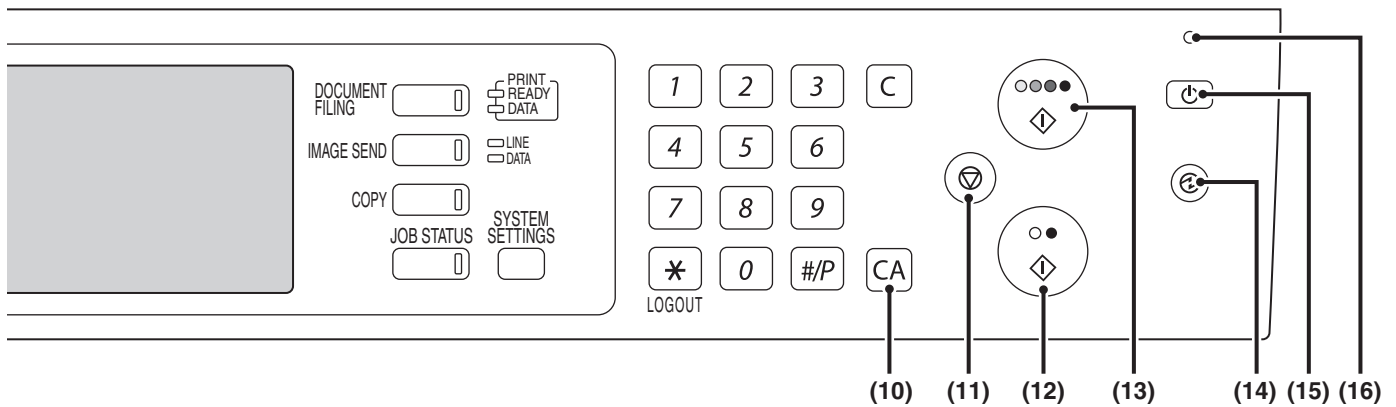

**(10) [CLEAR ALL] key (CA)**

Press this key to return to the initial operation state.  
Use this key when you wish to cancel all settings that have been selected and start operation from the initial state.

**(11) [STOP] key (⏏)**

Press this key to stop a copy job or scanning of an original.

**(12) [BLACK & WHITE START] key (○●)**

Press this key to copy or scan an original in black and white. This key is also used to send a fax in fax mode.

**(13) [COLOR START] key (○○●●)**

Press this key to copy or scan an original in color.  
This key cannot be used for fax or Internet fax.

**(14) [POWER SAVE] key (⏻) / indicator**

Use this key to put the machine into auto power shut-off mode to save energy.

The [POWER SAVE] key blinks when the machine is in auto power shut-off mode.

➤ [\[POWER SAVE\] KEY](#) (page 14)

**(15) [POWER] key (⏻)**

Use this key to turn the machine power on and off.

➤ [TURNING THE POWER ON AND OFF](#) (page 13)

**(16) Main power indicator**

This lights up when the machine's main power switch is in the "On" position.

➤ [TURNING THE POWER ON AND OFF](#) (page 13)

# TOUCH PANEL

The touch panel (screen) shown in this manual is a descriptive image. The actual screen is slightly different.

## Using the touch panel

### Example 1

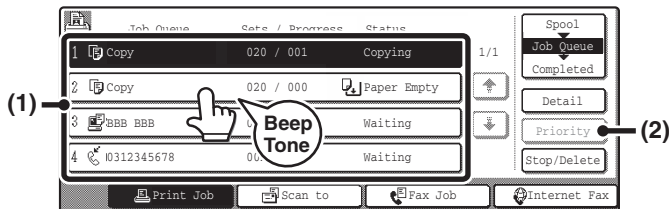

- (1) Settings for each function are easily selected and canceled by touching the keys on the screen with your finger. When an item is selected, a beep will sound and the item will be highlighted to confirm the selection.
- (2) Keys which are grayed out cannot be selected.

### Example 2

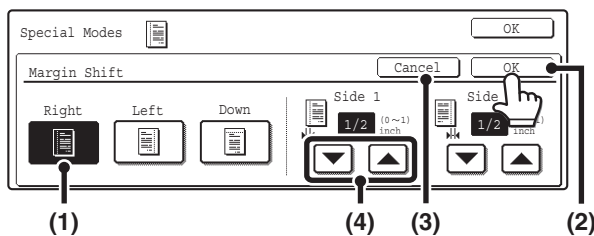

- (1) If a key is initially highlighted in a screen, the key is selected. To change the selection, touch one of the other keys to highlight that key.
- (2) Touch the [OK] key to enter the selection.
- (3) Touch this key to cancel the setting.
- (4) The keys can be used to increase or decrease a value. To make a value change quickly, keep your finger on the key.

### Example 3

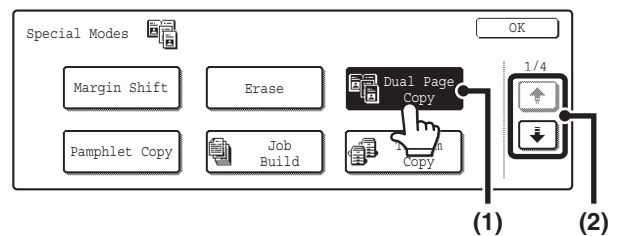

- (1) Some items in the special modes screen are selected by simply touching the key of the item. To cancel a selected item, touch the highlighted key once again so that it is no longer highlighted.
- (2) When settings extend over multiple screens, touch the key or the key to switch through the screens.

### Example 4

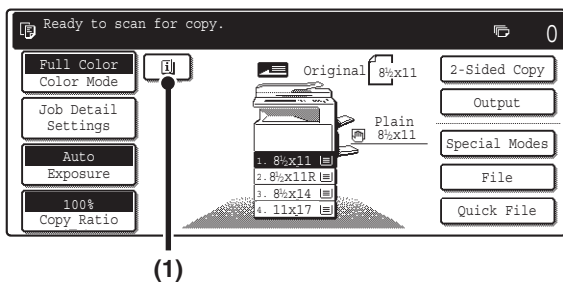

- (1) When at least one special mode is selected, the key appears in the base screen.

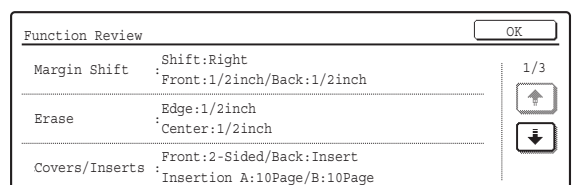

- (2) The key can be touched to display a list of the selected special modes.



If a key that cannot be selected is touched, a double beep will sound.



#### System Settings (Administrator): Key Touch Sound at Initial Point

This is used to adjust the volume of the beep that sounds when keys are touched. The key touch sound can also be turned off.

# PRINT/SEND STATUS (JOB STATUS)

This screen appears when the [JOB STATUS] key on the operation panel is pressed.

The screen shows lists of the jobs that are reserved and in progress, and jobs that have been completed. This screen is used to check jobs, move a job to the top of the job queue, or delete a job.

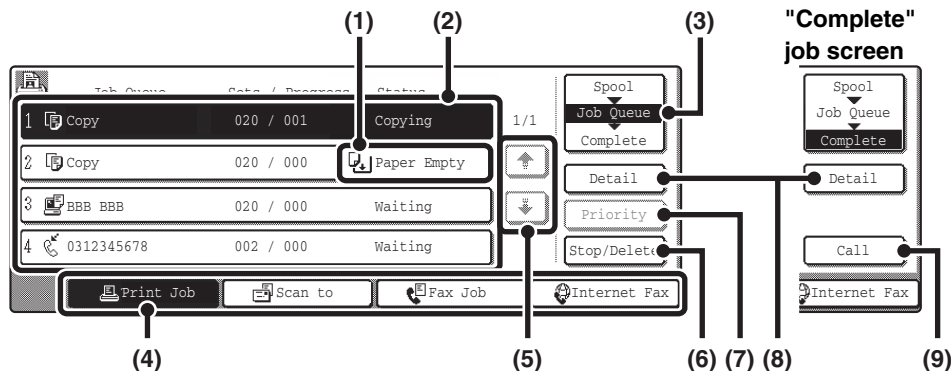

## (1) "Paper Empty" display

Add paper.

When the status is "Paper Empty", the specified size of paper for the job is not loaded in any of the trays. In this case, the job will be held until the required size of paper is loaded. Other jobs that are waiting will be printed (if possible) ahead of the held job. (However, other jobs will not be printed if the paper ran out while printing was in progress.)

If you need to change the paper size because the specified paper size is not available, touch the key of the job in the list to select it, touch the [Detail] key described in (8), and select a different paper size.

## (2) Job list

- Lists are displayed of jobs that are, reserved and in progress (the job queue), and completed.  
When the [Print Job] key is touched in the mode switch keys, the job status screen selector key changes to show the "Spool" list.  
Each job key in the lists shows a brief description of the job and its status.
- The "Spool" screen shows spooled print jobs and encrypted PDF direct print jobs. To move an encrypted PDF job from the spool list to the "Job Queue", touch the key of the job and enter the job password.

## (3) Job status screen selector key

This switches the job list display to spooled jobs, the job queue, or completed jobs.

[Spool]: This shows encrypted PDF jobs printed by direct printing. The [Spool] list can be displayed when print jobs are spooled.

[Job Queue]: This shows reserved jobs and the job in progress.

[Complete]: This shows completed jobs.

## (4) Mode switch keys

Use these keys to switch to print mode, scan mode, fax mode, or Internet fax mode.

- The [Print Job] key shows the list of copy, print, received fax, received Internet fax, and self print jobs.

- The [Scan to] key shows the list of transmission jobs that use the scanner function.
  - The [Fax Job] key shows the list of transmission jobs that use the fax and PC-Fax functions.
  - The [Internet Fax] key shows the list of transmission jobs that use the Internet fax and PC-I-fax functions.
- For more information on the job status screen in each mode, see the manual for each mode.

## (5) Up/Down arrow keys

These change the page of the displayed job list.

## (6) [Stop/Delete] key

Use this key to cancel the job currently in progress or a selected reserved job. Note that printing of received faxes and received Internet faxes cannot be canceled.

## (7) [Priority] key

A reserved job in the "Job Queue" screen can be printed ahead of all other reserved jobs by selecting the job and then touching this key.

In the print job queue, you can select a print or copy job to which you wish to give priority and touch this key. The job in progress stops and printing of the selected job begins. When the selected job is completed, the interrupted job resumes.

## (8) [Detail] key

This shows detailed information on a selected job. When a job has been stored using Quick File or File in document filing mode, or when a broadcast transmission has been performed in image send mode, the job appears as a key in the [Complete] screen. You can touch this key to show details on the completed job, and you can also touch the [Call] key that appears to reprint or resend the job.

## (9) [Call] key

A job that appears in the completed jobs screen as a key can be touched followed by the [Call] key to reprint or resend the job. This is the same [Call] key that appears when the [Detail] key is touched.

---

---

# TURNING THE POWER ON AND OFF

The machine has two power switches. The main power switch is at the lower left after the front cover is opened. The other power switch is the [POWER] key (  ) on the operation panel at the top right.

## Main power switch

When the main power switch is switched on, the main power indicator on the operation panel lights up.

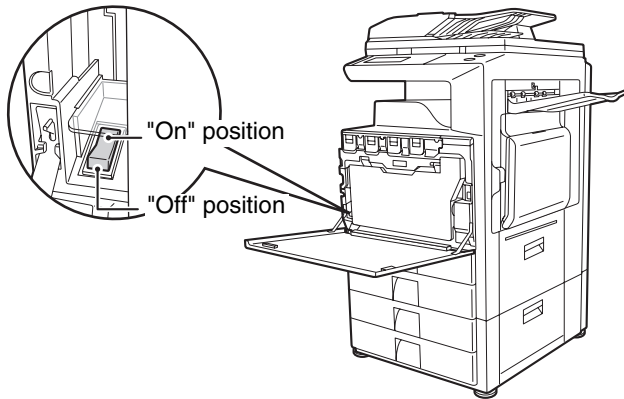

## [POWER] key

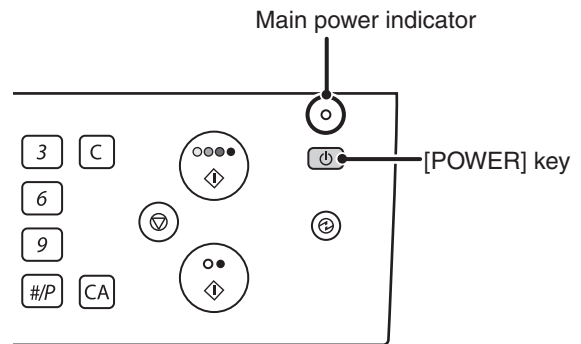

## Turning on the power

- (1) Switch the main power switch to the "On" position.
- (2) Press the [POWER] key (  ) to turn on the power.

## Turning off the power

- (1) Press the [POWER] key (  ) to turn off the power.
- (2) Switch the main power switch to the "Off" position.

## When using the fax or Internet fax functions

Always keep the main power switch in the "On" position.

Keep the main power switch in the "On" position and press the [POWER] key (  ) to turn off the power.

The power should be turned off in this way at night or at other times when the machine is not being used.



The touch panel cannot be used, but the following functions will operate:

### Fax functions:

Faxes can be received automatically, and timer transmission jobs and other previously reserved fax jobs can be transmitted. In addition, functions that send faxes at the request of other machines (remote transmission, relay transmission when a relay request is received) can also be used.

### Internet fax functions:

Internet faxes can be received automatically, and timer transmission jobs and other previously reserved fax jobs can be transmitted.

- Before switching off the main power switch, make sure that the DATA indicator for printing and the DATA and LINE indicators for image transmission and fax transmission and reception are not lit or blinking. Switching off the main power switch or removing the power cord from the outlet while any of the indicators are lit or blinking may damage the hard drive and cause data to be lost.
- Switch off both the main power switch and the [POWER] key (  ) and unplug the power cord if you suspect a machine failure, if there is a bad thunderstorm nearby, or when you are moving the machine.
- If the main power is switched off more than approximately one minute after the power has been turned off by pressing the [POWER] key (  ) on the operation panel, the main power indicator on the operation panel will not turn off immediately. (The indicator will remain on for approximately another minute. This is normal and does not indicate a failure.)

# ENERGY SAVE FUNCTIONS

This product has the following two energy save functions that conform to the Energy Star guidelines to help conserve natural resources and reduce environmental pollution.

## Preheat Mode

Preheat mode automatically lowers the temperature of the fuser unit and thereby reduces power consumption if the machine remains in the standby state for the interval of time set in "Preheat Mode" in the system settings (administrator).

The machine automatically wakes up and returns to normal operation when a print job is received, a key is pressed on the operation panel, or an original is placed.

## Auto power shut-off mode (Sleep mode)

Auto power shut-off mode automatically shuts off power to the display and the fusing unit if the machine remains in the standby state for the interval of time set in "Auto Power Shut-Off" in the system settings (administrator). This mode provides the lowest level of power consumption. Considerably more power is saved than in preheat mode, however, the wakeup time is longer. This mode can be disabled in the system settings (administrator).

The machine automatically wakes up and resumes normal operation when a print job is received or when the blinking [POWER SAVE] key is pressed.

## [POWER SAVE] KEY

Press the [POWER SAVE] key to put the machine in auto power shut-off mode or wake it up from auto power shut-off mode. The [POWER SAVE] key has an indicator that indicates whether or not the machine is in auto power shut-off mode.

<b>When the [POWER SAVE] key indicator is off.</b>	The machine is ready to be used. If the [POWER SAVE] key is pressed when the indicator is off, the indicator will blink and the machine will enter auto power shut-off mode after a brief interval.
<b>When the [POWER SAVE] key indicator light is blinking</b>	The machine is in auto power shut-off mode. If the [POWER SAVE] key is pressed when the indicator is blinking, the indicator will turn off and the machine will return to the ready state after a brief interval.

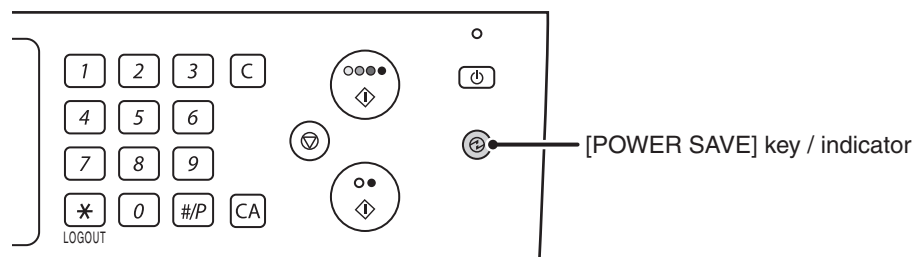

# USER AUTHENTICATION

When the administrator of the machine has enabled user authentication, one of two screens shown below will appear. If either screen appears, enter the user number or login name and password that you received from the administrator.

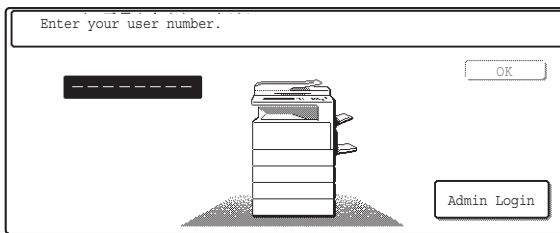

When controlled by user number

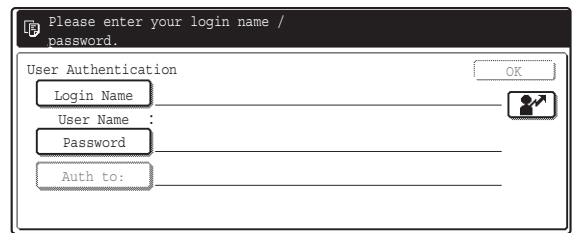

When controlled by login name and password

(Different items will appear in the screen when LDAP authentication is used.)

## AUTHENTICATION BY USER NUMBER

The following procedure is used to log in using a user number received from the administrator of the machine.

1

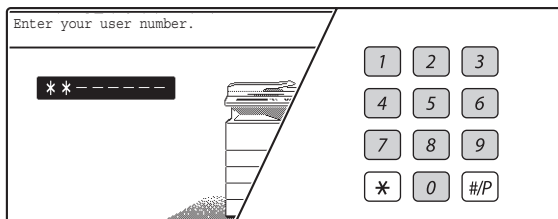

**Enter your user number (5 to 8 digits) with the numeric keys.**

Each entered digit will be displayed as "\*" .

2

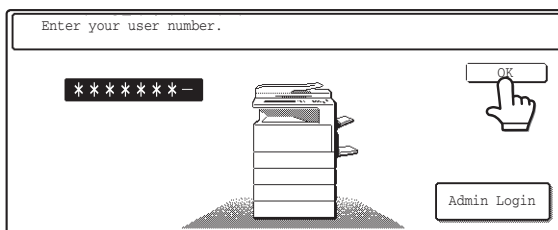

**Touch the [OK] key.**

After the entered user number is authenticated, the user count screen will appear briefly.

Usage status	: used/remaining pages
Black-white	: 87,654,321/12,345,678
Full color	: 87,654,321/12,345,678
2-color	: 87,654,321/12,345,678
Single color	: 87,654,321/12,345,678

The number of pages remaining appears when page limits have been set in "Pages Limit Group Registration" in the system settings (administrator). (The remaining number of pages that the user can use in each mode (copy, scan, etc.) appears.) The amount of time that this screen appears can be changed using "Message Time Setting" in the system settings (administrator).



When the user number is an 8-digit number, this step is not necessary. (Login takes place automatically after the user number is entered.)



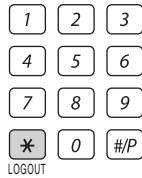

**When you have finished using the machine and are ready to log out, press the [LOGOUT] key ( \* ).**

**3**



- Note that the [LOGOUT] key ( \* ) cannot be used to log out when a fax number is being entered in fax mode, as [LOGOUT] key ( \* ) input is treated as part of a fax number.
- If a preset duration of time elapses after the machine is last used, the Auto Clear function will activate. When Auto Clear activates, logout automatically takes place. However, when PC Scan mode is used, logout does not take place when the [LOGOUT] key ( \* ) is pressed and Auto Clear does not operate. Change to a different mode on the machine and then log out.

### **If an incorrect user number is entered 3 times in a row...**

If "A Warning when Login Fails" is enabled in the system settings (administrator), the machine will lock for 5 minutes if an incorrect user number is entered 3 times in a row.

Verify the user number that you should use with the administrator of the machine.



The administrator can clear the locked state. This is done from [User Control] and then [Default Settings] in the Web page menu.

# AUTHENTICATION BY LOGIN NAME / PASSWORD

The following procedure is used to log in using a login name and password received from the administrator of the machine or the administrator of the LDAP server.

1

**Touch the [Login Name] key or the  key.**

If the [Login Name] key is touched, a screen for selecting the user name appears. Go to the next step.

If the  key is touched, [---] (the registration number display) appears in the 2-line message display.

Use the numeric keys to enter your registration number that has been stored in "User Registration" in the system settings (administrator). After entering the registration number, go to step 3.

2

**Select your user name.**

**(A) User selection keys**

Touch your user name that has been stored in "User Registration" in the system settings (administrator).

**(B) Index tabs**

All users appear on the [All Users] tab. Touch a tab to display the users whose leading initials match the tab index.

**(C) [Direct Entry] key**

Use this key if you have not been stored in "User Registration" in the system settings (administrator) and have only been stored for LDAP authentication.

A text entry screen will appear. Enter your login name that is stored on the LDAP server.

To enter text, see "[6. ENTERING TEXT](#)" (page 64).

**(D) [Back] key**

Touch this key to return to the login screen.



LDAP authentication can be used when the administrator of the server provides LDAP service on the LAN (local area network).

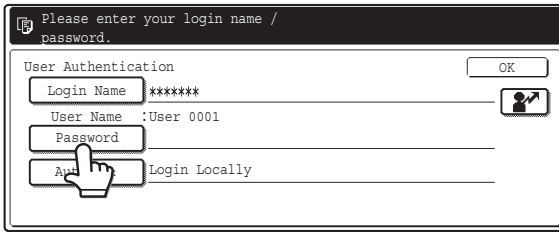

## Touch the [Password] key.

A text entry screen for entering the password will appear. Enter your password that is stored in "User Registration" in the system settings (administrator).

If you are logging in to an LDAP server, enter the password that is stored with your LDAP server login name.

Each entered character will be displayed as "\*". When you have finished entering the password, touch the [OK] key.

When authentication is by LDAP server and you have different passwords stored in "User Registration" in the system settings (administrator) and in the LDAP server, use the password stored in the LDAP server.



### • If you are logging in using a user selection key...

If you are logging in using a user selection key, the LDAP server was stored when your user information was stored, and thus the LDAP server will appear in an authenticated server when you select your login name. Go to step 4.

### • When logging in using the [Direct Entry] key...

Touch the [Auth to:] key.

3

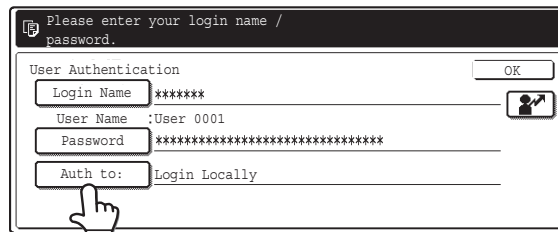

Select the LDAP server and touch the [OK] key.

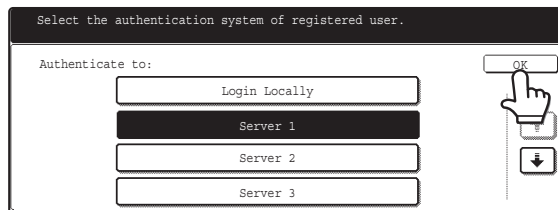

4

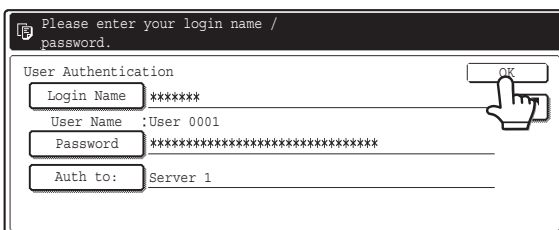

## Touch the [OK] key.

After the entered login name and password are authenticated, the user count screen will appear briefly.

```
Usage status      : used/remaining pages
Black-white      : 87,654,321/12,345,678
Full color       : 87,654,321/12,345,678
2-color          : 87,654,321/12,345,678
Single color     : 87,654,321/12,345,678
```

The number of pages remaining appears when page limits have been set in "Pages Limit Group Registration" in the system settings (administrator). (The remaining number of pages that the user can use in each mode (copy, scan, etc.) appears.) The amount of time that this screen appears can be changed using "Message Time Setting" in the system settings (administrator).



When you have finished using the machine and are ready to log out, press the [LOGOUT] key (**\***).



- Note that the [LOGOUT] key (**\***) cannot be used to log out when a fax number is being entered in fax mode, as [LOGOUT] key (**\***) input is treated as part of a fax number.
- If a preset duration of time elapses after the machine is last used, the Auto Clear function will activate. When Auto Clear activates, logout automatically takes place. However, when PC Scan mode is used, logout does not take place when the [LOGOUT] key (**\***) is pressed and Auto Clear does not operate. Change to a different mode on the machine and then log out.

### If an incorrect login name or password is entered 3 times in a row...

If "A Warning when Login Fails" is enabled in the system settings (administrator), the machine will lock for 5 minutes if an incorrect login name or password is entered 3 times in a row.

Verify the login name and password that you should use with the administrator of the machine.



- The administrator can clear the locked state. This is done from [User Control] and then [Default Settings] in the Web page menu.
- Depending on the LDAP authentication method, the [E-mail Address] key may appear. If the [E-mail Address] key appears in step 3, touch it.  
A text entry screen will appear.  
Enter your e-mail address. To enter text, see "6. ENTERING TEXT" (page 64).



### System Settings (Administrator): User Registration

A user name is stored when a user is registered in "User Registration". Detailed information such as the login name, user number, and password are also stored. Ask the administrator of the machine for the information that you need to use the machine.

# 2 LOADING PAPER

This chapter explains how to load paper in the machine's trays.

## IMPORTANT POINTS ABOUT PAPER

This section provides information that you should know before loading paper in the paper trays. Be sure to read this section before loading paper.

## NAMES AND LOCATIONS OF TRAYS

The trays are identified by the names indicated below. For the sizes and types of paper that can be loaded in each tray, see the Safety Guide.

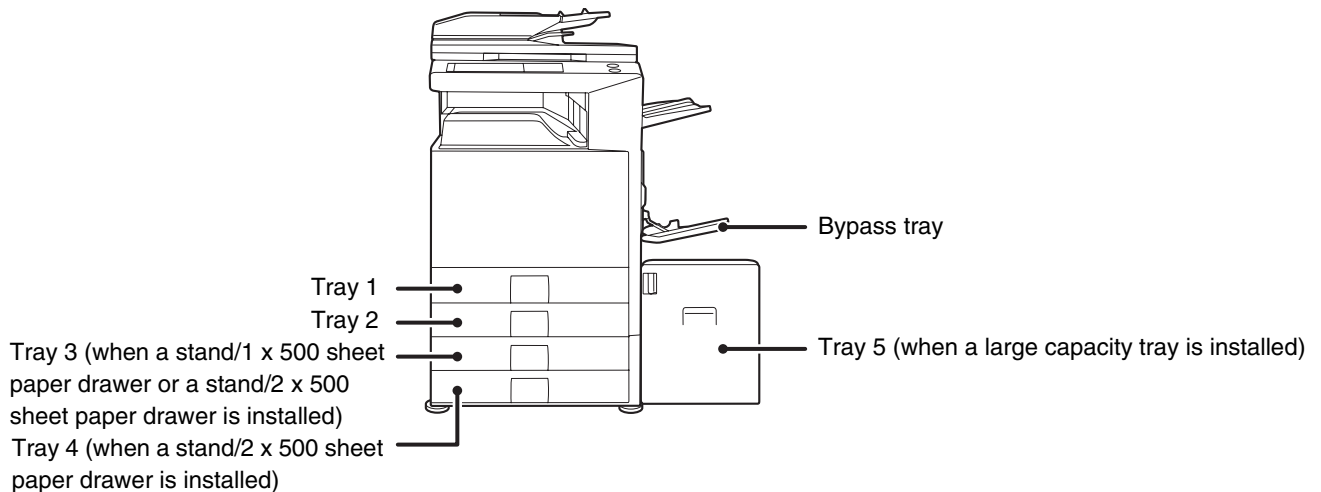

## Tray numbers

The tray numbers vary depending on the peripheral devices that are installed.

Peripheral devices installed	The machine		Stand/1 x 500 sheet paper drawer	Stand/2 x 500 sheet paper drawer		Large capacity tray
	First tray	Second tray		First tray	Second tray	
Stand/1 x 500 sheet paper drawer + Large capacity tray			Tray 3	–	–	Tray 4
Stand/2 x 500 sheet paper drawer + Large capacity tray	Tray 1	Tray 2	–	Tray 3	Tray 4	Tray 5
None installed			–	–	–	–

The explanations in this manual assume that a stand/2 x 500 sheet paper drawer and large capacity tray are installed. If your machine has a stand/1 x 500 sheet paper drawer and a large capacity tray installed, substitute "Tray 4" wherever "Tray 5" appears in this manual.

# THE MEANING OF "R" IN PAPER SIZES

Some original and paper sizes can be placed in either the vertical or the horizontal orientation. To differentiate between vertical and horizontal orientations, paper sizes in the horizontal orientation will be followed by an "R" (for example, 8-1/2" x 11"R, 5-1/2" x 8-1/2"R, A4R, B5R).

Sizes that can be placed only in the horizontal orientation (11" x 17", 8-1/2" x 14", 8-1/2" x 13", A3, B4) do not include "R" in their size indication.

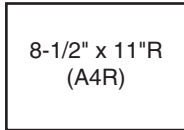

**Horizontal orientation**  
"R" is appended.

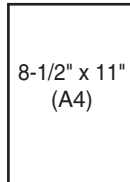

**Vertical orientation**  
"R" is not appended.

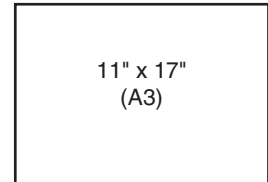

**Can be placed only in the horizontal orientation**  
"R" is not appended.

## USEABLE PAPER

Various types of paper are sold. This section separately explains the plain paper and the special media that can be used with the machine. For detailed information on the sizes and types of paper that can be loaded in each tray of the machine, see the specifications in the Safety Guide and "Paper Tray Settings" in the System Settings Guide.

	Useable paper	Remarks
Tray 1 to tray 5	Plain paper	See "More information on plain paper and special paper" below.
Bypass tray	Plain paper Special paper	

## More information on plain paper and special paper

### Plain paper that can be used in tray 1 to tray 5

- SHARP standard paper (see the Safety Guide for the specifications of (17 lbs. (64 g/m<sup>2</sup>)) SHARP standard paper).
- Plain paper other than SHARP standard paper (16 lbs. to 28 lbs. (60 g/m<sup>2</sup> to 105 g/m<sup>2</sup>))
  - Recycled paper, colored paper and pre-punched paper must meet the same specifications as plain paper. Contact your dealer or nearest SHARP Service Department for advice on using these types of paper.

### Special media that can be used in the bypass tray

- Transparency film
- Heavy paper, postcards, label sheets, envelopes, glossy paper, tab paper, and other special media

## Paper that cannot be used

- Special media for inkjet printers (fine paper, glossy paper, glossy film, postcards, etc.)
- Carbon paper or thermal paper
- Pasted paper
- Paper with clips
- Paper with fold marks
- Torn paper
- Oil-feed transparency film
- Thin paper less than 15 lbs. (55 g/m<sup>2</sup>)
- Heavy paper 57 lbs. (210 g/m<sup>2</sup>) or over
- Return postcard with a fold
- Irregularly shaped paper
- Stapled paper
- Damp paper
- Curled paper
- Paper with a wave-like pattern due to moisture absorption

## Paper that is not recommended

- Iron-on transfer paper
- Japanese paper
- Return postcard without a fold
- The reverse side of paper already printed on by another printer or copier.
- Perforated paper



- Various types of plain paper and special media are sold. Some types cannot be used with the machine. Contact your dealer or nearest SHARP Service Department for advice on suitable paper.
- The image quality and toner fusibility of paper may change due to ambient conditions, operating conditions, and paper characteristics, resulting in image quality inferior to that of SHARP standard paper. Contact your dealer or nearest SHARP Service Department for advice on suitable paper.
- The use of non-recommended or prohibited paper may result in skewed feeding, misfeeds, poor toner fusing (the toner does not adhere to the paper well and can be rubbed off), or machine failure.
- The use of non-recommended paper may result in misfeeds or poor image quality. Before using non-recommended paper, check if printing can be performed properly.

---

---

# TRAY SETTINGS FOR TRAYS 1 TO 4

## LOADING PAPER

A maximum of 500 sheets of paper from size 5-1/2" x 8-1/2"R to size 11" x 17" (A5R to A3) can be loaded in trays 1 and 2. A maximum of 500 sheets of paper from size 7-1/4" x 10-1/2"R to size 11" x 17" (B5R to A3) can be loaded in trays 3 and 4. For detailed information on the paper that can be loaded, see the specifications in the Safety Guide and "Paper Tray Settings" in the System Settings Guide.

1

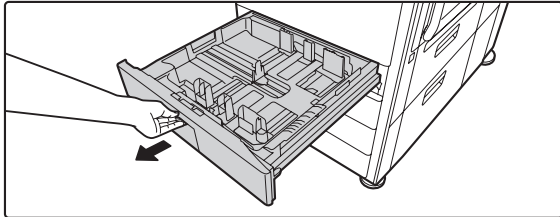

### Pull out the paper tray.

Gently pull the tray out until it stops.

2

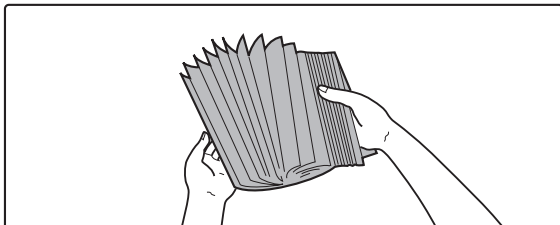

### Fan the paper.

Before loading the paper, fan it well. If the paper is not fanned, multiple sheets may feed at once and cause a misfeed.

3

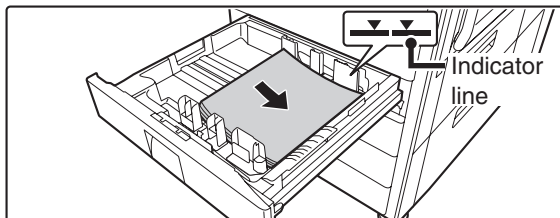

### Insert the paper into the tray.

Insert the paper with the print side face up. However, letterhead and pre-printed paper should be inserted with the print side face down.

The paper stack must not be higher than the indicator line (no more than 500 sheets).



If "Disabling of Duplex" is enabled in the system settings (administrator), insert letterhead and pre-printed paper with the print side face up.

4

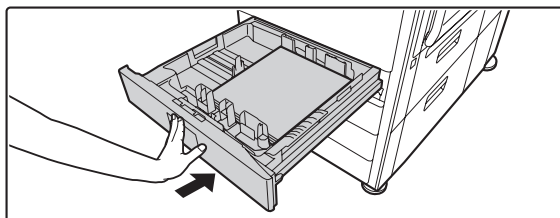

### Gently push the paper tray into the machine.

Push the tray firmly all the way into the machine.



When loading paper, if you change the paper size from an inch size to an AB size, or from an AB size to an inch size, or if you change the paper type, be sure to change the paper type setting as explained in "Paper Tray Settings" in the System Settings Guide.



Do not place heavy objects on the tray or press down on the tray.



# CHANGING THE PAPER SIZE

1

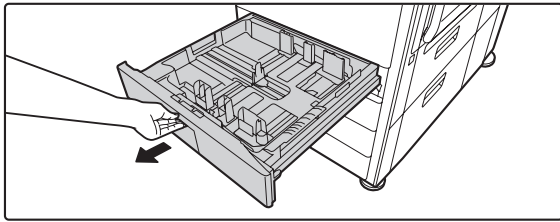

## Pull out the paper tray.

Gently pull the tray out until it stops.  
If paper remains in the tray, remove it.

2

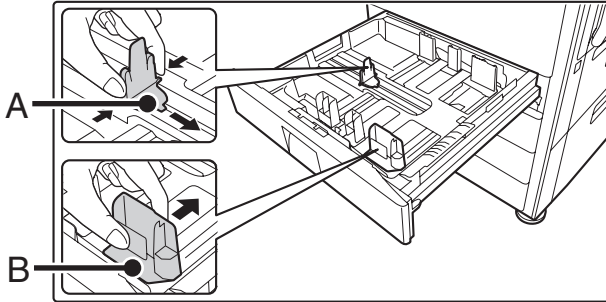

## Adjust the guide plates A and B by squeezing their lock levers and sliding them to match the vertical and horizontal dimensions of the paper to be loaded.

The guide plates A and B are slidable. Slide each guide plate while squeezing its lock lever.

3

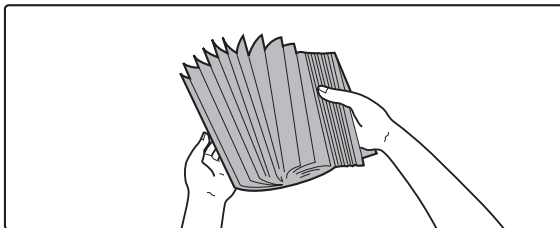

## Fan the paper.

Before loading the paper, fan it well. If the paper is not fanned, multiple sheets may feed at once and cause a misfeed.

4

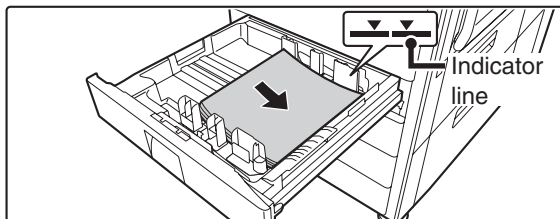

## Insert the paper into the tray.

Insert the paper with the print side face up.  
However, letterhead and pre-printed paper should be inserted with the print side face down.  
The paper stack must not be higher than the indicator line (no more than 500 sheets).



If "Disabling of Duplex" is enabled in the system settings (administrator), insert letterhead and pre-printed paper with the print side face up.

5

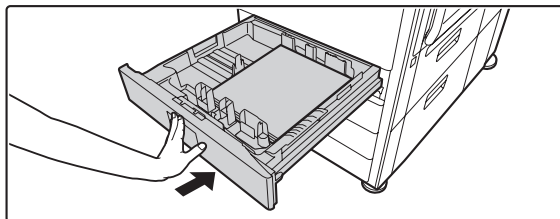

## Gently push the paper tray into the machine.

Push the tray firmly all the way into the machine.

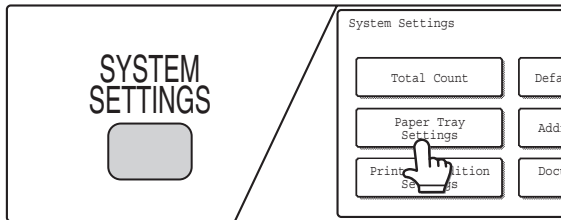

## Set the paper size and paper type.

Be sure to change the paper size and paper type settings as explained in "Paper Tray Settings" in the System Settings Guide.

When the size of paper used in a tray is changed, the correct paper size setting must be selected. If the paper size setting is incorrect, the wrong size of paper will be selected when automatic paper selection operates, preventing printing or causing a misfeed or other problem.



Do not place heavy objects on the tray or press down on the tray.



### If you changed the paper loaded in tray 1 to tray 4...

See the System Settings Guide to change the paper size setting and paper type setting.



### System Settings: Paper Tray Settings

Change these settings when you change the size or type of paper loaded in a tray.

---

---

# LOADING PAPER IN TRAY 5 (Large capacity tray)

The large capacity tray can hold up to 3500 sheets of 8-1/2" x 11" or A4 size paper (20 lbs. (80 g/m<sup>2</sup>)).

The paper size of tray 5 can only be changed by a SHARP service technician.

For detailed information on the paper that can be loaded, see the specifications in the Safety Guide and "Paper Tray Settings" in the System Settings Guide.

1

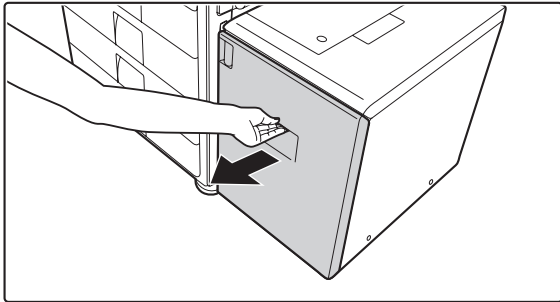

## Pull out tray 5.

Gently pull the tray out until it stops.

2

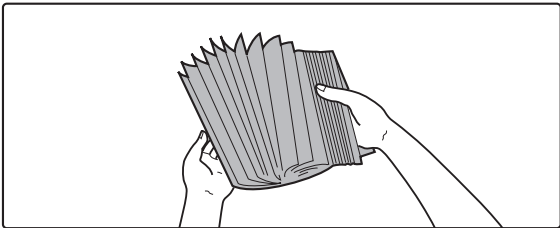

## Fan the paper.

Before loading the paper, fan it well. If the paper is not fanned, multiple sheets may feed at once and cause a misfeed.

3

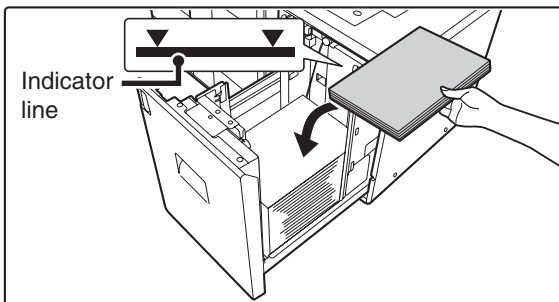

## Place the paper in the center of the paper table.

The paper stack must not be higher than the indicator line (no more than 3500 sheets).

4

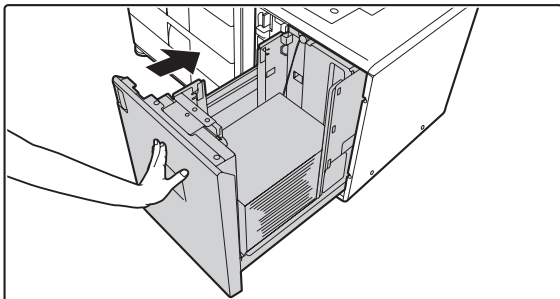

## Gently push the paper tray into the machine.

Push the tray firmly all the way into the machine.



Do not place heavy objects on the tray or press down on the tray.



When you change the type of paper loaded in tray 5, change the paper type setting in "Paper Tray Settings" in the system settings. See the System Settings Guide to change the paper type setting.



**System Settings: Paper Tray Settings**

Change these settings when you change the type of paper loaded in the tray.

---

---

# LOADING PAPER IN THE BYPASS TRAY

The bypass tray can be used to print and copy on plain paper, postcards, envelopes, label sheets, tab paper, and other special types of paper. Up to 100 sheets of paper can be loaded (up to 40 sheets of heavy paper or up to 20 postcards) for continuous printing similar to the other trays.

For detailed information on the paper that can be loaded, see the specifications in the Safety Guide and "Paper Tray Settings" in the System Settings Guide.

1

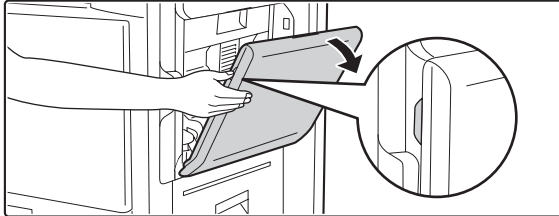

**Open the bypass tray.**

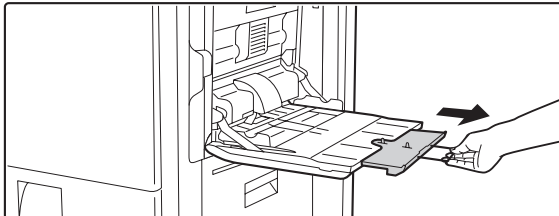

When loading paper larger than 8-1/2" x 11"R or A4R, be sure to pull out the bypass tray extension. Pull the bypass tray extension all the way out. If the bypass tray extension is not pulled all the way out, the size of the loaded paper will not be correctly displayed.

2

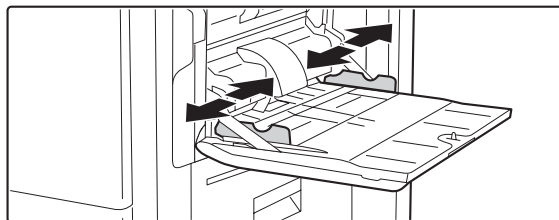

**Set the bypass tray guides to the width of the paper.**

3

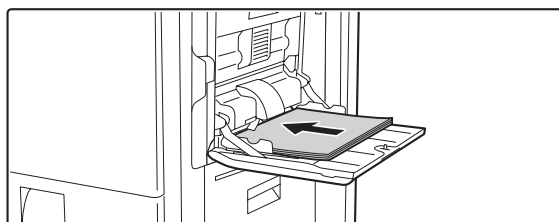

**Insert the paper along the bypass tray guides all the way into the bypass tray until it stops.**

Insert the paper with the print side face down.



- Do not force the paper in.
- If the bypass tray guides are set wider than the paper, move the bypass tray guides in until they correctly fit the width of the paper. If the bypass guides are set too wide, the paper may skew or be creased.

4

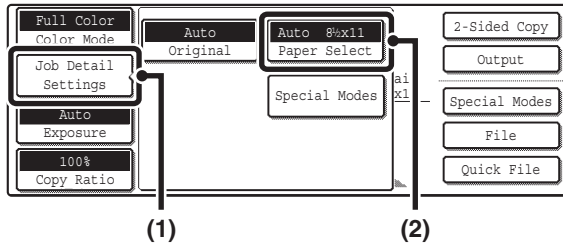

Open the paper settings screen.

(1) Touch the [Job Detail Settings] key.

(2) Touch the [Paper Select] key.

5

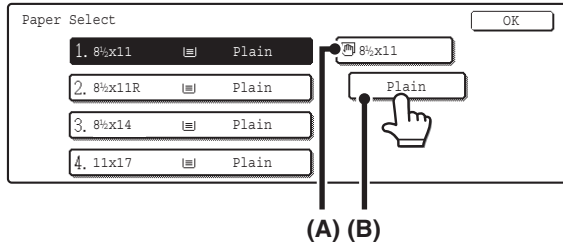

Touch the paper type key of the bypass tray.

(A) Shows the size of paper loaded in the bypass tray.

(B) The currently selected paper type will be displayed.

6

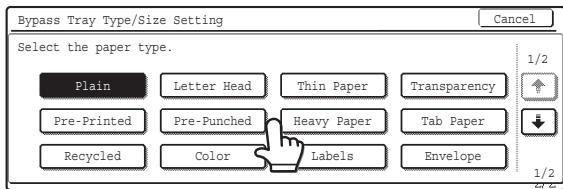

Select the type of paper used in the bypass tray.

Select the paper type to be used.

7

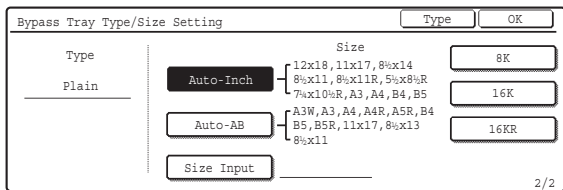

Set the paper size.

Touch the [Auto-Inch] key, the [Auto-AB] key, or the [Custom Size] key. To use a paper size used in China, touch [8K], [16K], or [16KR]. After selecting the setting, touch the [OK] key.

**[Auto-Inch] key**

When the paper inserted in the bypass tray is an inch size (8-1/2" x 11", etc.), the paper size will be detected automatically and the appropriate paper size set.

**[Auto-AB] key**

When the paper inserted in the bypass tray is an AB size (A4 size, etc.), the paper size will be detected automatically and the appropriate paper size set.

**[Custom Size] key**

Touch this key when you know the size of the inserted paper but it is not one of the inch or AB sizes.

When the key is touched, the paper size entry screen appears.

Touch the [X] key and enter the horizontal dimension of the paper with the  $\downarrow$   $\uparrow$  keys, and then touch the [Y] key and enter the vertical dimension. When finished, touch the [OK] key.

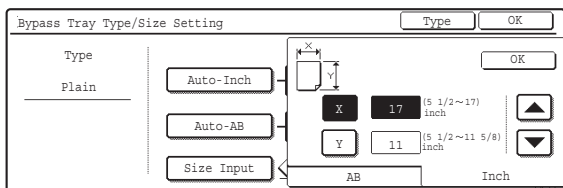

- When the [Envelope] is selected, touch the envelopes size key. When finished, touch the [OK] key.
- When [Tab Paper] is selected, check the tab paper size, or touch the [Auto-Inch] key or the [Auto-AB] key. When finished, touch the [OK] key.

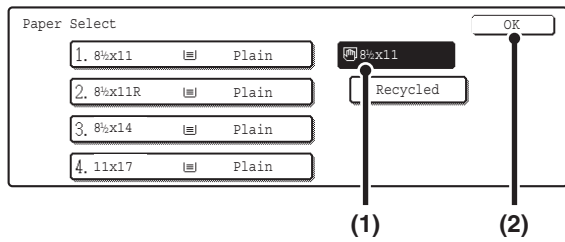

## Select the bypass tray.

- (1) Touch the paper size key of the bypass tray.
- (2) Touch the [OK] key.



Do not place heavy objects on the bypass tray or press down on the tray.

## IMPORTANT POINTS WHEN USING THE BYPASS TRAY

- When using plain paper other than SHARP standard paper or special types of paper other than SHARP-recommended transparency film, or are printing on the reverse side of previously used paper, the paper must be loaded one sheet at a time. Loading more than one sheet at a time will cause misfeeds.
- Before loading paper, straighten any curling in the paper.
- When adding paper, remove any paper remaining in the tray, combine it with the paper to be added, and reload as a single stack. If paper is added without removing the remaining paper, a misfeed may result.
- When using glossy paper, set the paper type to [Heavy Paper]. This will bring out the glossy quality of the paper.

### Inserting paper

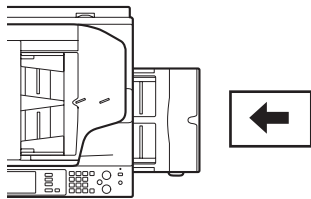

7-1/4" x 10-1/2", A5 or less size paper must be inserted in the horizontal orientation as shown at left.

### Inserting tab paper

When copying on tab paper, orient the paper so that the side with the tabs enters the machine last. The bottom side of the inserted paper will be printed on.

Place the tab paper and original as shown below.

Original		Tab paper	Copy
Automatic document feeder	Document glass		

When copying onto tab paper, insert the tab paper with the side to be copied on face down in the bypass tray.

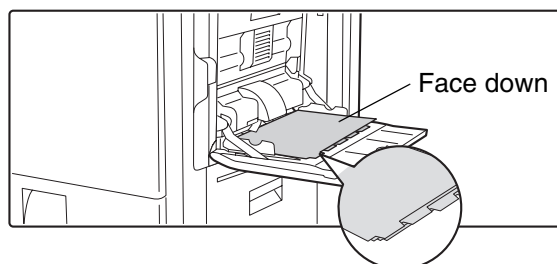

Use only tab paper that is made of paper. Tab sheets made of film or other material cannot be used.

## Inserting transparency film

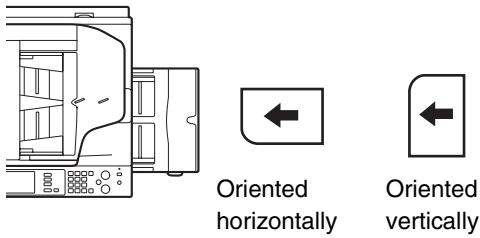

- Use SHARP-recommended transparency film. When inserting transparency film in the bypass tray, the rounded corner should be at the front left when the film is oriented horizontally, or at the far left when the film is oriented vertically.
- When loading multiple sheets of transparency film in the bypass tray, be sure to fan the sheets several times before loading.
- When printing or copying on transparency film, be sure to remove each sheet as it exits the machine. Allowing sheets to stack in the output tray may result in curling.

## Inserting postcards and envelopes

When inserting envelopes or postcards in the bypass tray, set them in the orientation shown below.

### Example of inserting a postcard

Insert the postcard with the side to be printed on or copied on face down.

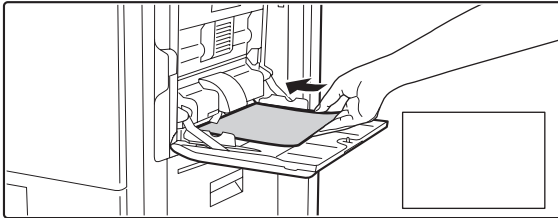

### Example of loading an envelope

Only the address side of an envelope can be printed on or copied on. Be sure to place the address side face down.

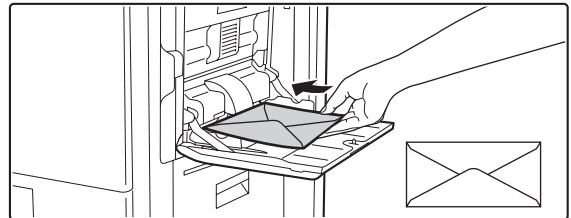

## Important points when inserting postcards and envelopes

Do not print or copy on both sides of the postcard or envelope. This may result in misfeeds or poor print quality.

## Important points when using envelopes

- Restrictions apply to some types of envelopes. For more information, consult a qualified service technician.
- Some operating environments may cause creasing, smudging, misfeeds, poor toner fusing, or machine failure.
- Do not use the following envelopes:
  - Envelopes with metal clasps, plastic hooks, or ribbon hooks; envelopes closed with string, envelopes with windows or backing, envelopes with an uneven front surface due to embossing, double-layer envelopes, envelopes with an adhesive for sealing, hand-made envelopes, envelopes with air inside, envelopes with creases or fold marks, torn or damaged envelopes
- Envelopes with an incorrectly aligned corner gluing position on the back cannot be used as creasing may result.
- Print quality is not guaranteed in the area 13/32" or 10 mm around the edges of the envelope.
- Print quality is not guaranteed on parts of envelopes where there is a large step-like change of thickness, such as on four-layer parts or parts less than 3 layers.
- Print quality is not guaranteed on envelopes having peel off flaps for sealing the envelopes.

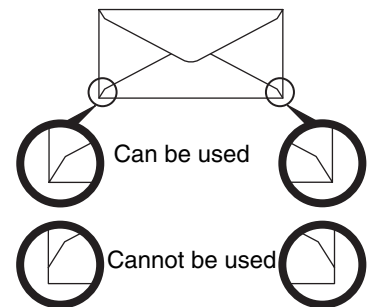



## Fusing unit pressure adjusting levers

In some cases damage to the envelopes, color deviations, or smudging may occur even if envelopes within the specifications are used. This problem may be alleviated by shifting the fusing unit pressure adjusting levers from their "normal pressure position" to the "lower pressure position". Follow the procedure on this page.

1

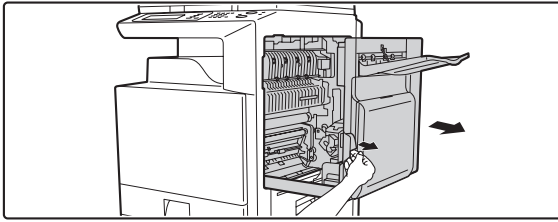

### Pull out the right side cover.

While pushing up the open/close lever on the right side cover, gently open the cover.

2

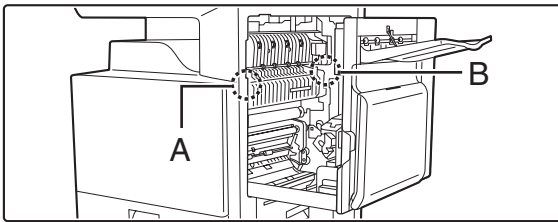

### Move the fusing unit pressure adjusting levers (two) to the lower pressure position as shown.

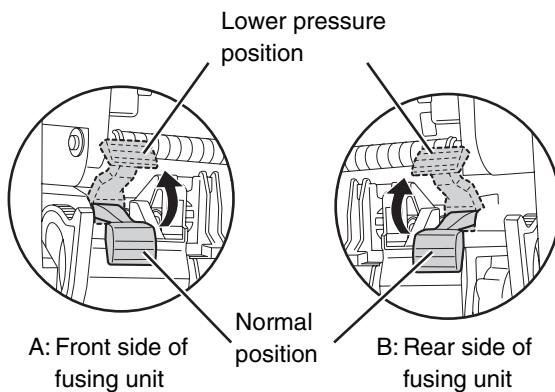

3

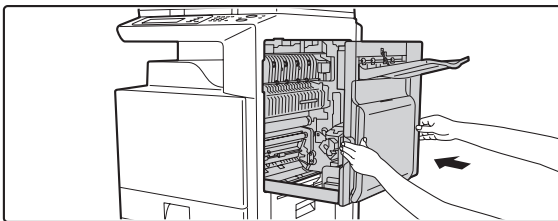

### Close the right side cover.

### Caution

The fusing unit is hot. Take care not to burn yourself when operating the fusing unit pressure adjusting levers.



Be sure to return the levers to the "normal pressure position" before printing or copying on paper other than envelopes. Otherwise, fusing problems, paper misfeeds, or equipment failure may occur.

# 3 ORIGINALS

This chapter explains how to place originals in the automatic document feeder and on the document glass.

## PLACING THE ORIGINAL

### PLACING ORIGINALS IN THE AUTOMATIC DOCUMENT FEEDER

This section explains how to place originals in the automatic document feeder.

#### Allowed original sizes

Minimum original size	Maximum original size
<b>Standard sizes</b> (minimum size that can be automatically detected) 8-1/2" (width) x 5-1/2" (length) A5: 210 mm (width) x 148 mm (length) <b>Non-standard sizes</b> (minimum size that can be specified manually) 5-1/8" (width) x 5-3/4" (length) 131 mm (width) x 143 mm (length)	<b>Standard sizes</b> (maximum size that can be automatically detected) 11" (width) x 17" (length) A3: 297 mm (width) x 420 mm (length) 12" x 18" size paper (A3W) cannot be used. <b>Non-standard sizes</b> (maximum size that can be specified manually) Copy mode: 297 mm (width) x 432 mm (length) In image send mode, up to 297 mm (width) x 800 mm (length) is possible.

When a non-standard size original is placed in copy mode, see "SPECIFYING THE ORIGINAL SIZE" in the Copier Guide.

When a non-standard size original is placed for a fax or scanner transmission, see "SPECIFYING THE SCAN SIZE OF THE ORIGINAL" in the Facsimile Guide or Scanner Guide.

#### Allowed original weights

1-sided copying: 9 lbs. to 34 lbs. (35 g/m<sup>2</sup> to 128 g/m<sup>2</sup>)

2-sided copying: 15 lbs. to 28 lbs. (50 g/m<sup>2</sup> to 105 g/m<sup>2</sup>)

To scan originals from 9 lbs. to 14 lbs. (35 g/m<sup>2</sup> to 49 g/m<sup>2</sup>), use "Slow Scan Mode" in the special modes. Scanning without using "Slow Scan Mode" may result in original misfeeds.

When "Slow Scan Mode" is selected, automatic two-sided scanning is not possible.

1

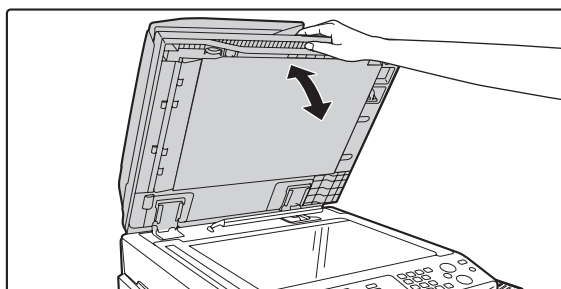

#### Make sure an original does not remain on the document glass.

Open the automatic document feeder, make sure that an original is not on the document glass, and then gently close the automatic document feeder.

2

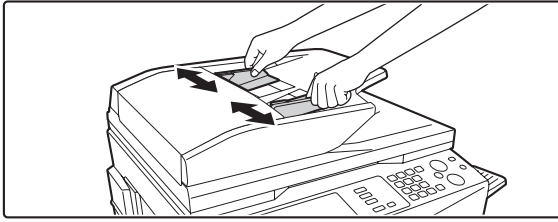

**Adjust the original guides to the size of the originals.**

3

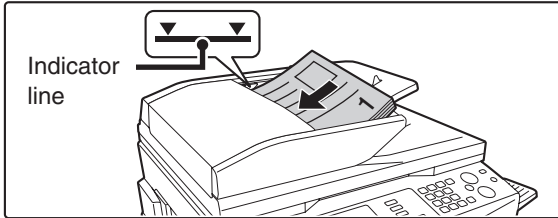

**Place the original.**

Make sure the edges of the originals are even. Insert the originals face up all the way into the document feeder tray.

The stack of originals must not be higher than the indicator line (maximum of 100 sheets).

## Mixed size originals (placing different sizes of originals together)

When using the automatic document feeder, originals of different sizes in the range of combinations shown below can be scanned together.

When scanning mixed sizes of originals, be sure to touch the [Mixed Size Original] key in the special modes and select [Same Width] or [Different Width].

The following combinations of original sizes can be used.

### When the originals are the same width

Touch the [Mixed Size Original] key in the special modes and select [Same Width].

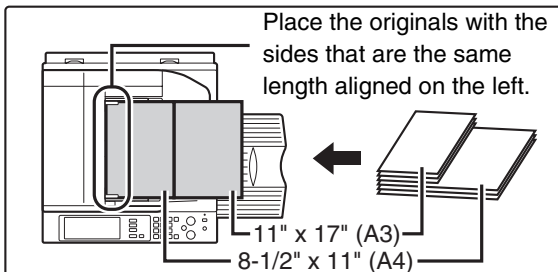

### Allowed combinations of sizes

11" x 17" and 8-1/2" x 11", 8-1/2" x 14" and 8-1/2" x 11"R, 8-1/2" x 14" and 5-1/2" x 8-1/2", 8-1/2" x 13" and 8-1/2" x 11"R, 8-1/2" x 13" and 5-1/2" x 8-1/2", 8-1/2" x 11"R and 5-1/2" x 8-1/2" (A3 and A4, B4 and B5, A4R and A5)

### When the originals are different widths

Touch the [Mixed Size Original] key in the special modes and select [Different Width].

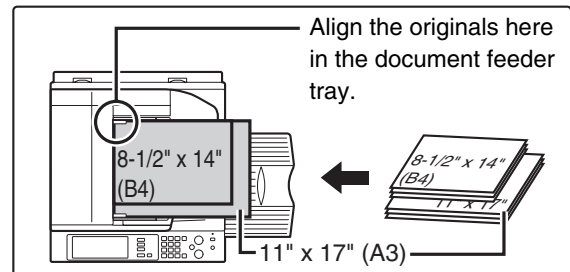

### Allowed combinations of sizes

11" x 17" and 8-1/2" x 14", 11" x 17" and 8-1/2" x 13", 11" x 17" and 5-1/2" x 8-1/2" (A3 and B4, A3 and B5, A4 and B4, A4 and B5, B4 and A4R, B4 and A5, B5 and A4R, B5 and A5)

Combinations of sizes other than the above cannot be used for "Different Width". 2-sided scanning is not possible when "Different Width" is selected.



- Before inserting originals into the document feeder tray, be sure to remove any staples or paper clips.
- If originals have damp spots due to correction fluid, ink or pasteup glue, wait until the originals are dry before making copies. Otherwise the interior of the document feeder or the document glass may be soiled.
- Do not use the following originals. Incorrect original size detection, original misfeeds, and smudges may result.  
Transparency film, tracing paper, carbon paper, thermal paper or originals printed with thermal transfer ink ribbon should not be fed through the document feeder. Originals to be fed through the feeder should not be damaged, crumpled, folded, loosely pasted together, or have cut-out holes. Originals with multiple punched holes other than two-hole or three-hole punched paper may not feed correctly.
- When using originals with two or three holes, place them so that the punched edge is at a position away from the feed slot.

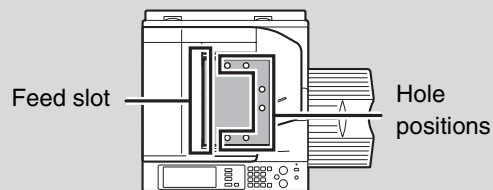

# PLACING THE ORIGINAL ON THE DOCUMENT GLASS

This section explains how to place the original on the document glass.

## Allowed original sizes

Maximum original size
<b>Standard sizes</b> 11" (width) x 17" (length) A3: 297 mm (width) x 420 mm (length)
<b>Non-standard sizes</b> 297 mm (width) x 432 mm (length)

When a non-standard size original is placed in copy mode, see "SPECIFYING THE ORIGINAL SIZE" in the Copier Guide.

When a non-standard size original is placed for a fax or scanner transmission, see "SPECIFYING THE SCAN SIZE OF THE ORIGINAL" in the Facsimile Guide or Scanner Guide.

1

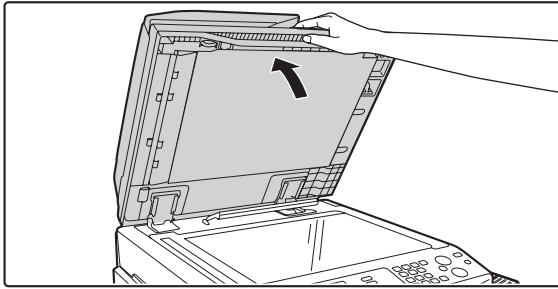

**Open the automatic document feeder.**

2

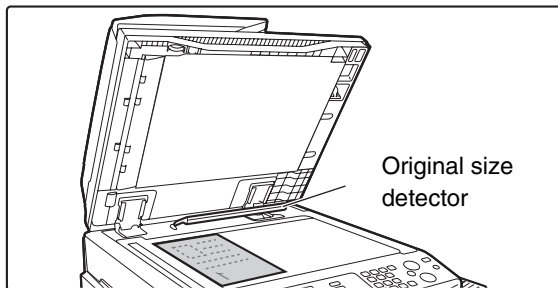

**Place the original.**

Place the original face down in the far left corner of the document glass.

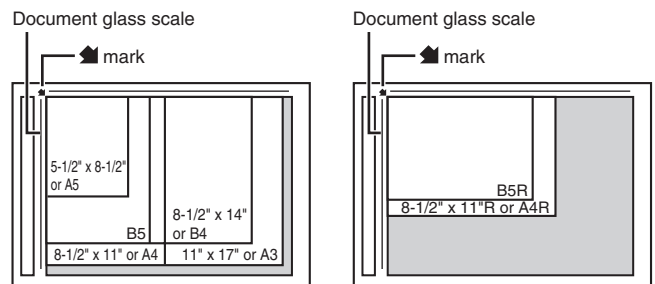

**The original should always be placed in the far left corner, regardless of the size.**

Align the top left corner of the original with the tip of the  mark.



- Do not place any objects under the original size detector. Closing the automatic document feeder with an object underneath may damage the original size detector and prevent correct detection of the original size.
- If you are placing a small original on the document glass, it is convenient to place a blank sheet of 8-1/2" x 11" or 5-1/2" x 8-1/2" (A4 or B5) paper on top of the original.

3

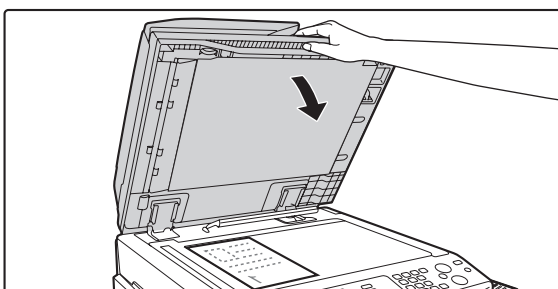

**Close the automatic document feeder.**

## Placing a thick book

When scanning a thick book or other thick original, follow the steps below to press the book down.

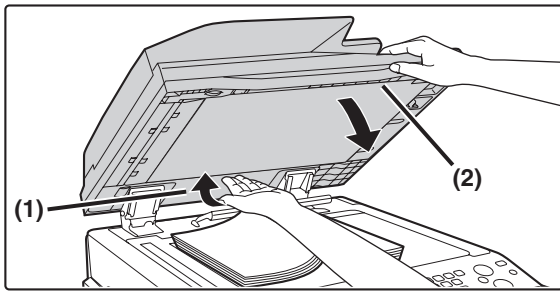

**(1) Push up the far side of the automatic document feeder.**

The hinges supporting the automatic document feeder will release and the rear side of the automatic document feeder will rise.

**(2) Gently close the automatic document feeder.**

### **Caution**

- Do not close the automatic document feeder suddenly. This may damage the automatic document feeder and your hand may become caught between the automatic document feeder and the machine.
- Do not place your hands inside the automatic document feeder. Your hand may become caught between the automatic document feeder and the machine.



The automatic document feeder cannot be closed correctly in this state. To return the automatic document feeder to its normal state, open it completely and then close it.

# 4 PERIPHERAL DEVICES

This chapter describes the peripheral devices that can be used with the machine and explains how to use the finisher and saddle stitch finisher.

## PERIPHERAL DEVICES

Peripheral devices can be installed on the machine to increase its range of functionality.

The peripheral devices are generally optional, however, some models include certain peripheral devices as standard equipment.

(As of August, 2005)

Product name	Product number	Description
Stand/1x500 sheet paper drawer	MX-DEX1	Additional tray. A maximum 500 sheets of paper can be loaded in each tray.
Stand/2x500 sheet paper drawer	MX-DEX2	
Large capacity tray	MX-LCX1	Additional tray. A maximum of 3500 sheets of paper can be loaded in the tray. To install the tray, a stand/1 x 500 sheet paper drawer or stand/2 x 500 sheet paper drawer is required.
Exit tray unit (Right tray)	MX-TRX1	This can be added to the right side of the machine.
Finisher	MX-FNX1	Output device that enables the use of the staple function and offset function.
Punch module	MX-PNX1A	Punches holes in copies and other output. Requires a finisher.
	MX-PNX1B	
	MX-PNX1C	
	MX-PNX1D	
Saddle stitch finisher	MX-FNX2	Output device that enables use of the staple function, offset function and pamphlet copy function. To install the saddle stitch finisher, a stand/1 x 500 sheet paper drawer or stand/2 x 500 sheet paper drawer is required.
Paper pass unit	MX-RBX1	Required when a saddle stitch finisher is installed.
Punch module	AR-PN1A	Punches holes in copies and other output. Requires a saddle stitch finisher.
	AR-PN1B	
	AR-PN1C	
	AR-PN1D	
Barcode font kit	AR-PF1	Adds barcode fonts to the machine.
PS3 expansion kit	MX-PKX1	Enables the machine to be used as a Postscript compatible printer.

<b>Product name</b>	<b>Product number</b>	<b>Description</b>
Internet fax expansion kit	MX-FWX1	Enables Internet Fax.
Facsimile expansion kit	MX-FXX1	Adds a fax function.



---

---

# FINISHER

The finisher is equipped with the offset function, which offsets each set of output from the previous set. In addition, each set of sorted output can be stapled. An optional hole punching unit can also be installed to punch holes in output.

## PART NAMES

The following parts can be accessed when the finisher is open.

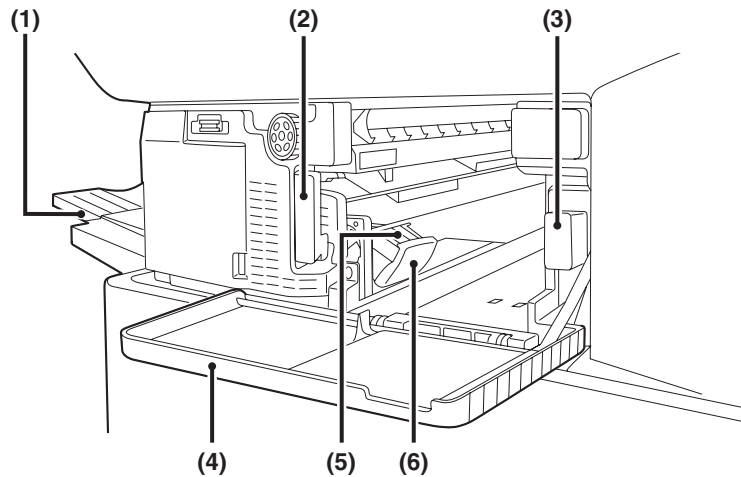

**(1) Output tray**

Stapled and offset output is delivered to this tray. The tray is slidable. Extend the tray for large output (12" x 18", 11" x 17", 8-1/2" x 14", 8-1/2" x 13" A3W, A3 and B4 sizes).

**(2) Lever**

Use this to move the finisher in order to remove a paper misfeed, replace staples, or remove a staple jam.

**(3) Punch waste box (when a punch module is installed)**

This holds punch waste.

**(4) Front cover**

Open this cover to remove a paper misfeed, replace staples, remove a staple jam, or remove the punch scrap case.

**(5) Staple case**

This holds the staple cartridge. Pull the case out to replace the staple cartridge or remove a staple jam.

**(6) Staple case release lever**

Use this to remove the staple case.



- A finisher and a saddle stitch finisher cannot be installed simultaneously.
- Use caution when you turn on the power and when printing is taking place, as the tray may move up and down.

## SUPPLIES

The finisher requires the following staple cartridge:

- Staple cartridge  
(approx. 5000 staples per cartridge x 3 cartridges)  
MX-SCX1

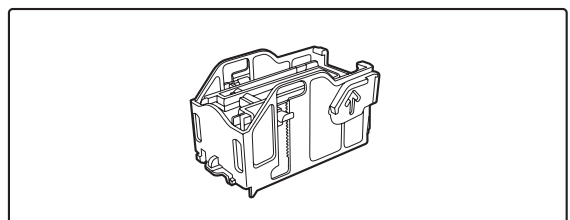

# FINISHER MAINTENANCE

When the staple cartridge runs out of staples, a message will appear in the operation panel. Follow the procedure below to replace the staple cartridge.

## Replacing the staple cartridge

1

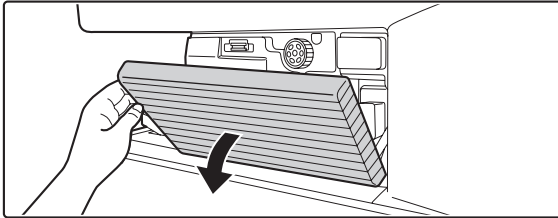

**Open the cover.**

2

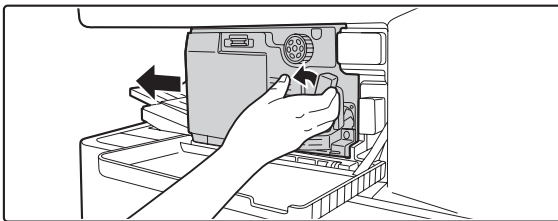

**While pressing the lever over to the left, slide the finisher to the left until it stops.**

Gently slide the finisher until it stops.

3

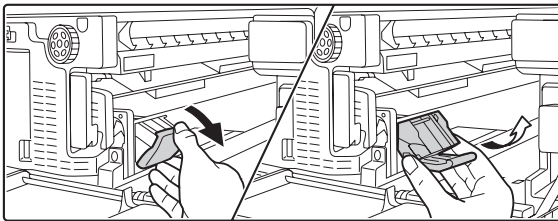

**Lower the staple case release lever and remove the staple case.**

Pull the staple case out to the right.

4

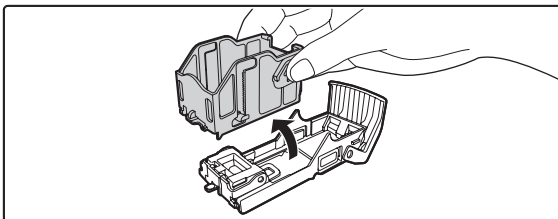

**Remove the empty staple cartridge from the staple case.**

5

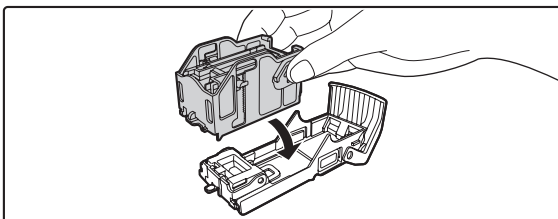

**Insert a new staple cartridge into the staple case as shown.**

Push the staple cartridge in until it clicks into place.

6

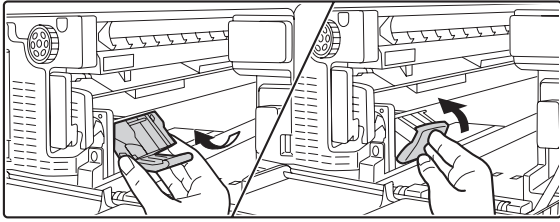

### Replace the staple case.

Push the staple case in until it clicks into place.

7

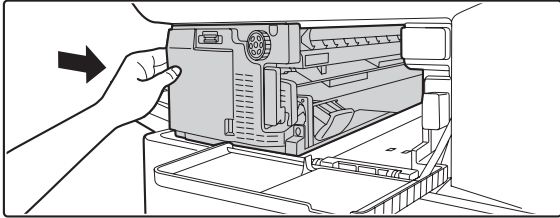

### Slide the finisher back to the right.

Gently slide the finisher back to the right until it locks into its original position.

8

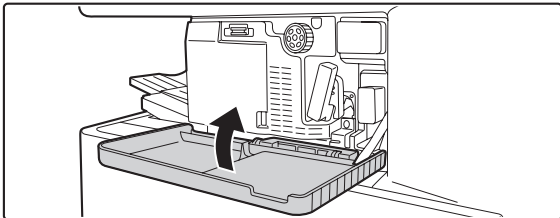

### Close the cover.



Make a test print or copy in staple sort mode to verify that stapling takes place correctly.

## Removing staple jams

Follow the steps below to remove a staple jam.

1

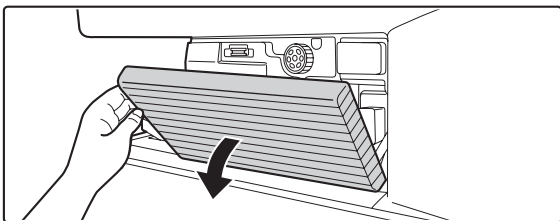

### Open the cover.

2

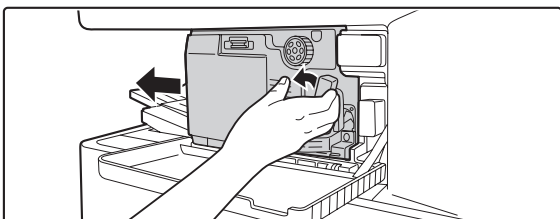

### While pressing the lever over to the left, slide the finisher to the left until it stops.

Gently slide the finisher until it stops.

3

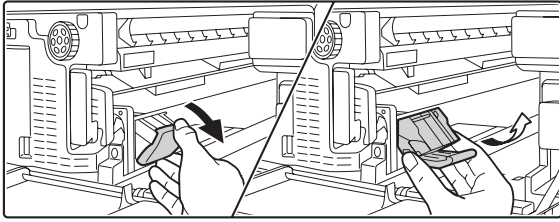

**Lower the staple case release lever and remove the staple case.**

Pull the staple case out to the right.

4

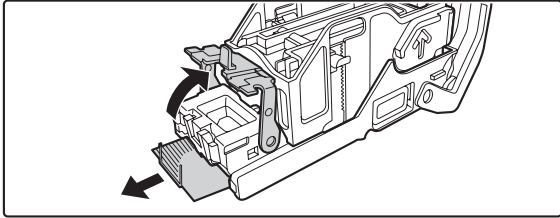

**Raise the lever at the front end of the staple case and remove the jammed staple.**

5

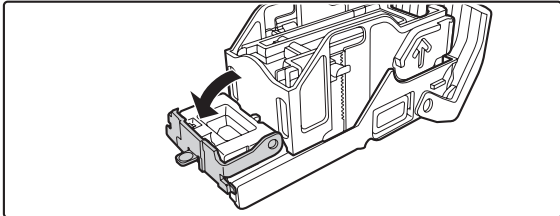

**Lower the lever at the front end of the staple case.**

6

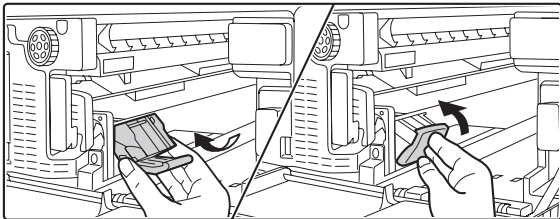

**Replace the staple case.**

Push the staple case in until it clicks into place.

7

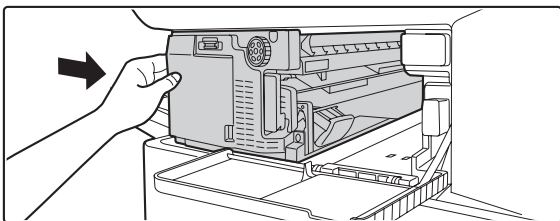

**Slide the finisher back to the right.**

Gently slide the finisher back to the right until it locks into its original position.

8

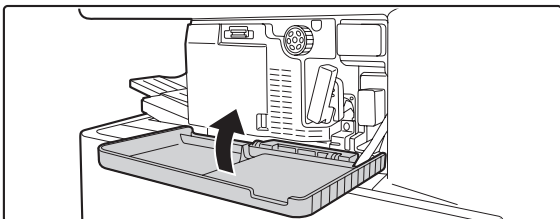

**Close the cover.**

## Discarding punch waste (when a punch module is installed)

1

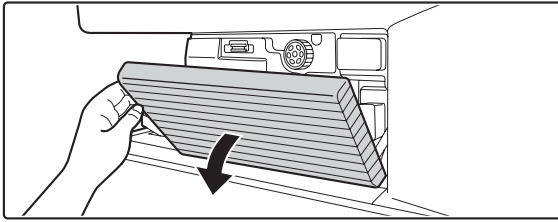

Open the cover.

2

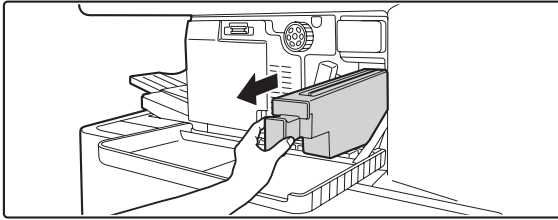

**Grasp the punch waste box handle, gently pull out the box, and discard the punch waste.**

Discard the punch waste in a plastic bag or other container, taking care not to let the waste scatter.

3

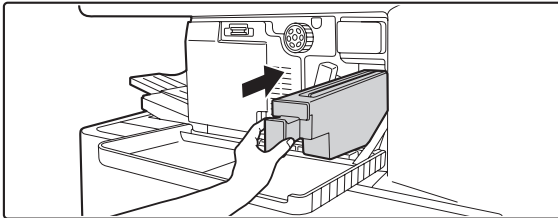

**Gently push the box back in.**

4

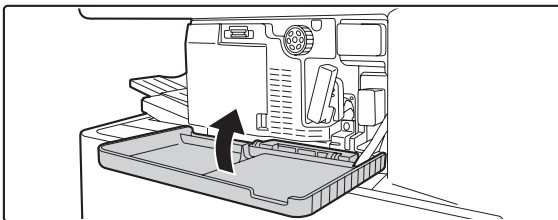

Close the cover.

---

---

# SADDLE STITCH FINISHER

The saddle stitch finisher is equipped with the offset function that offsets each set of output from the previous set, the staple sort function that staples each set of output, and the saddle stitch function that automatically staples and folds each set of output at the centerline.

An optional hole punching unit can also be installed to punch holes in output.

## PART NAMES

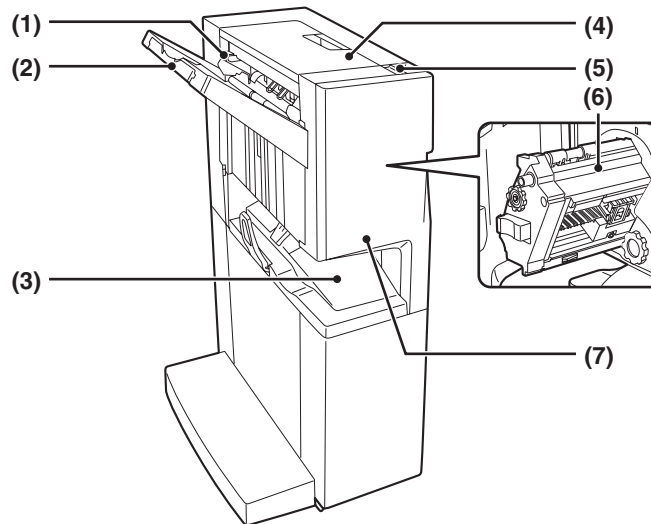

**(1) Stapler compiler**

This temporarily stacks paper to be stapled.

**(2) Output tray**

Stapled and offset output is delivered to this tray. The tray is slidable. Extend the tray for large output (12" x 18", 11" x 17", 8-1/2" x 14", 8-1/2" x 13", A3W, A3 and B4 sizes).

**(3) Saddle stitch tray**

Stapled and folded output is delivered to this tray.

**(4) Top cover**

Open this cover to remove a paper misfeed.

**(5) Lever**

To remove a staple jam or paper misfeed, pull this lever and slide the saddle stitch finisher to the left until it stop.

**(6) Stapler section**

Open the front cover and pull out this section to replace the staple cartridge or remove a staple jam.

**(7) Front cover**

Open this cover to replace the staple cartridge or remove a staple jam.



- A paper pass unit is required to install a saddle stitch finisher.
- Do not place heavy objects on the saddle stitch finisher or press down on the saddle stitch finisher.
- Use caution when you turn on the power and when printing is taking place, as the tray may move up and down.
- A saddle stitch finisher and a finisher cannot be installed simultaneously.

## SUPPLIES

The saddle stitch finisher requires the following staple cartridge:

- Staple cartridge  
(approx. 5000 staples per cartridge x 3 cartridges)  
AR-SC2

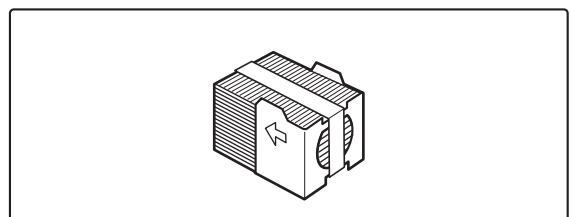

# SADDLE STITCH FINISHER MAINTENANCE

When the staple cartridge runs out of staples, a message will appear in the operation panel. Follow the procedure below to replace the staple cartridge.

## Replacing the staple cartridge

1

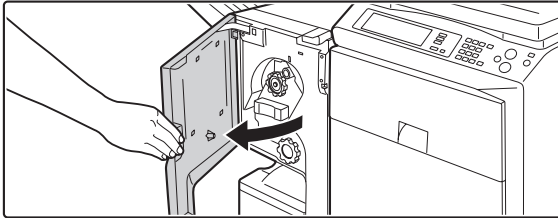

**Open the front cover.**

2

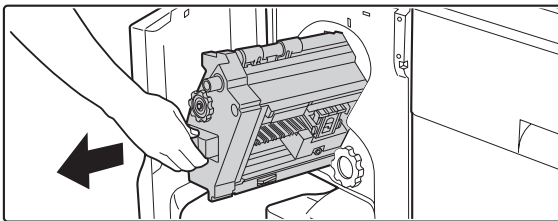

**Pull out the stapler section.**

Pull out until the stapler section until it stops.

3

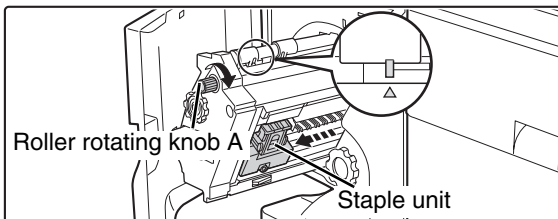

**Turn roller rotating knob A in the direction of the arrow to move the staple unit out to the front.**

Turn the roller rotating knob as shown until the triangle mark is aligned with the indicator.

4

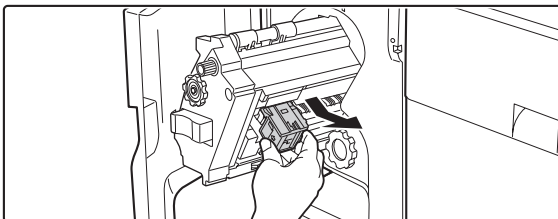

**Remove the empty staple case.**

5

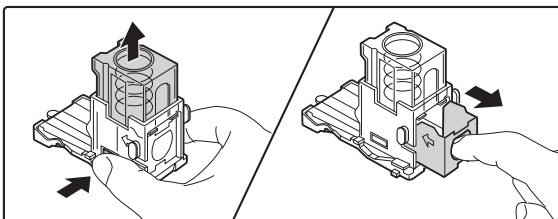

**Remove the empty staple cartridge.**

Press the lock button to release the staple case cover and then remove the staple cartridge.



When staples remain, the staple cartridge cannot be removed.

6

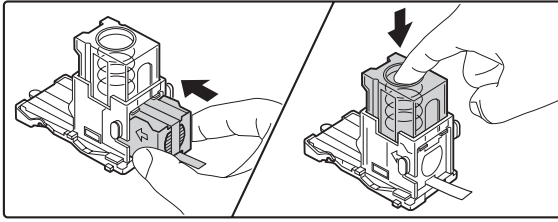

**Insert a new staple cartridge into the staple case.**

Push the staple cartridge in until it clicks into place.



Do not remove the seal from the cartridge before inserting the cartridge into the case.

7

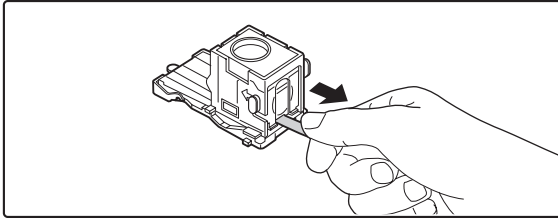

**Pull the seal that holds the staples straight out.**

8

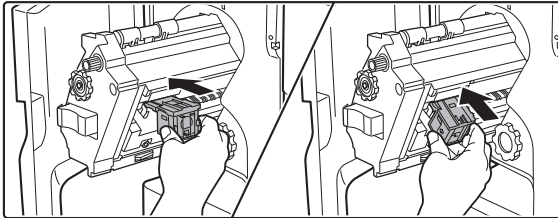

**Replace the staple case.**

Push the staple case in until it clicks into place.

9

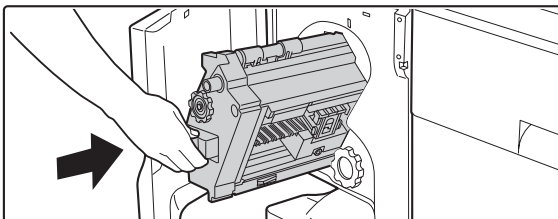

**Push the stapler section back in.**

Push the stapler section back in until it locks into its original position.

10

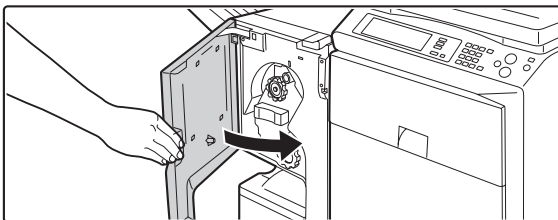

**Close the front cover.**



Make a test print or copy in staple sort mode to verify that stapling takes place correctly.



# Removing staple jams

Follow the steps below to remove a staple jam.

1

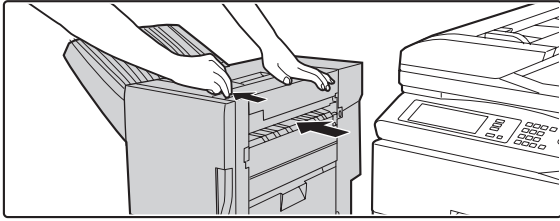

While pulling the lever, slide the saddle stitch finisher to the left until it stops.

2

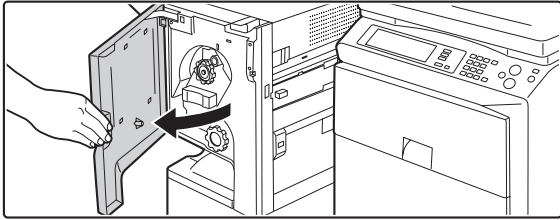

Open the front cover.

3

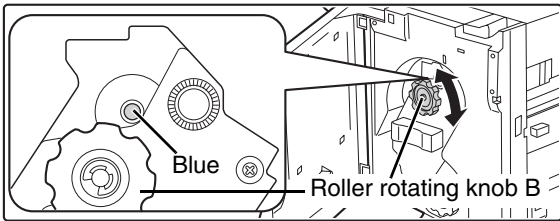

Turn roller rotating knob B as shown until the blue indicator is visible.

4

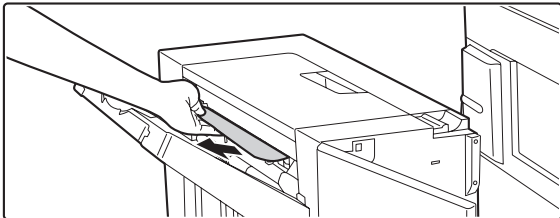

Remove any paper from the stapler compiler.

Be careful not to tear the paper during removal.

5

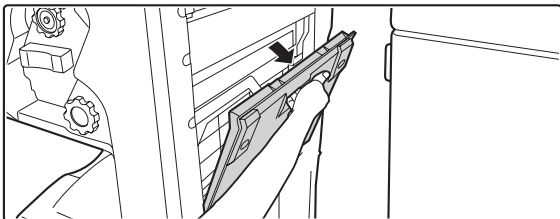

If the saddle stitch function was being used, open the saddle stitch section cover.

6

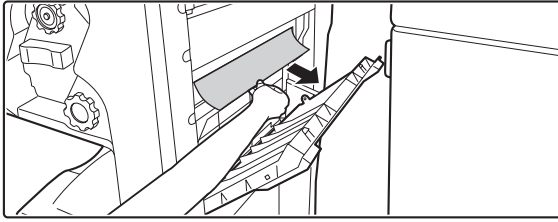

**Remove the misfed paper.**

Be careful not to tear the paper during removal.

7

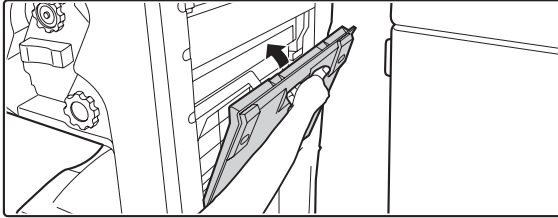

**Close the saddle stitch section cover.**

8

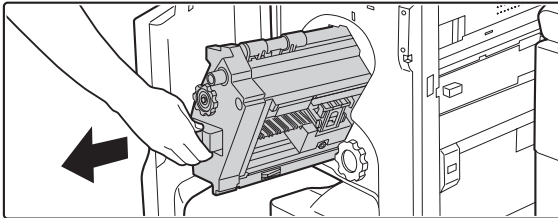

**Pull out the stapler section.**

Pull out until the stapler section until it stops.

9

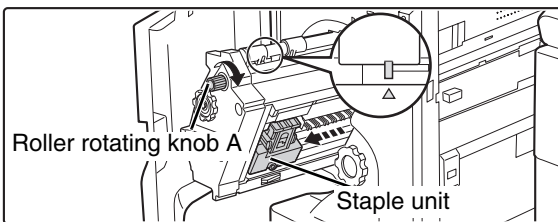

**Turn roller rotating knob A in the direction of the arrow to move the staple unit out to the front.**

Turn the roller rotating knob until the triangle mark is aligned with the indicator.

10

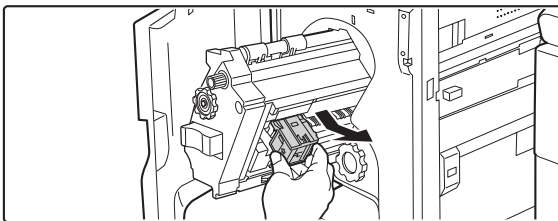

**Remove the staple case.**

11

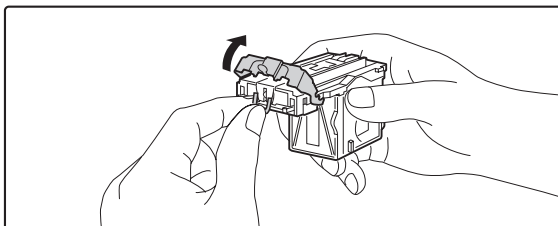

**Raise the lever at the front end of the staple case and remove the jammed staple.**

Remove the leading staple if it is bent. If bent staples remain, a staple jam will occur again.

12

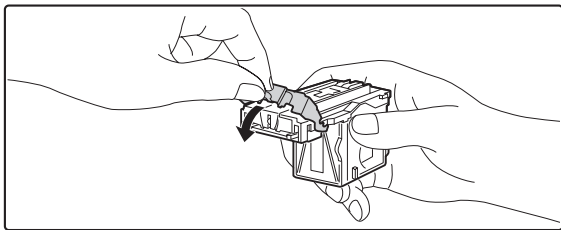

**Return the lever to its original position.**

13

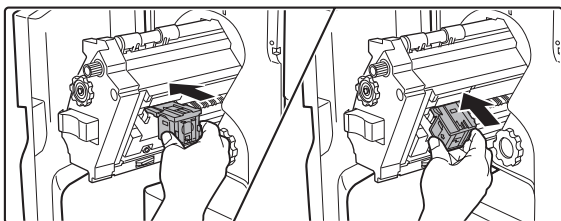

**Replace the staple case.**

Push the staple case in until it clicks into place.

14

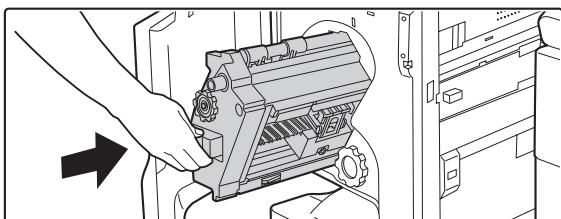

**Push the stapler section back in.**

Push the stapler section back in until it locks into its original position.

15



**Close the front cover.**

16

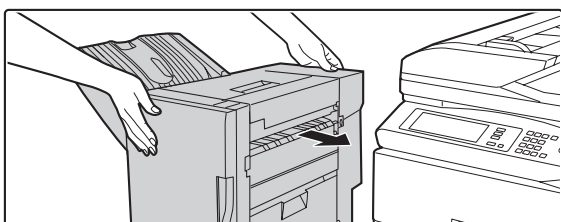

**Push the saddle stitch finisher back and latch it to the machine.**



Make a test print or copy in staple sort mode to verify that stapling takes place correctly.

## Discarding punch waste (when a punch module is installed)

1

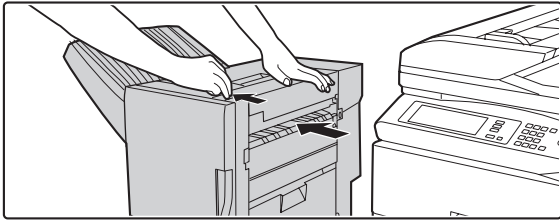

While pulling the lever, slide the saddle stitch finisher to the left until it stops.

2

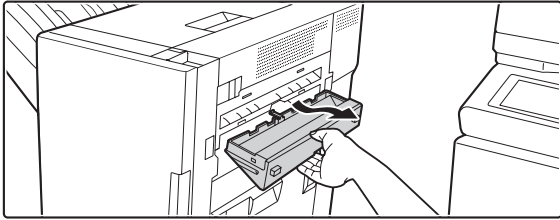

**Pull out the punch waste box and discard the punch waste.**

Discard the punch waste in a plastic bag or other container, taking care not to let the waste scatter.

3

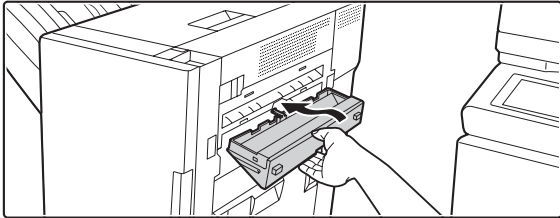

**Return the punch waste box to its original position.**

4

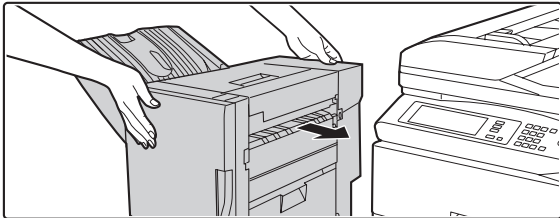

**Push the saddle stitch finisher back and latch it to the machine.**

# 5 MAINTENANCE

This chapter explains how to clean the machine and replace the toner cartridge or waste toner box.

## REGULAR MAINTENANCE

To ensure that the machine continues to provide top quality performance, periodically clean the machine.

### Warning

Do not use a flammable spray to clean the machine. If gas from the spray comes in contact with hot electrical components or the fusing unit inside the machine, fire or electrical shock may result.

 Do not use thinner, benzene, or similar volatile cleaning agents to clean the machine. These may degrade or discolor the housing.

## CLEANING THE DOCUMENT GLASS AND AUTOMATIC DOCUMENT FEEDER

If the document glass, document backplate sheet, or automatic document scanning area becomes dirty, the dirt will appear as dirty spots or colored lines or white lines in the scanned image. Always keep these parts clean.

Wipe the parts with a clean, soft cloth.

If necessary, moisten the cloth with water or a small amount of neutral detergent. After wiping with the moistened cloth, wipe the parts dry with a clean dry cloth.

### Document glass

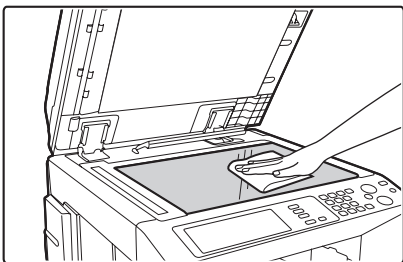

### Document backplate sheet

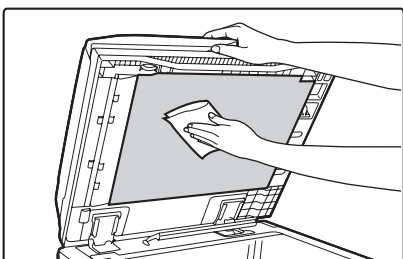

### Scanning area

If colored lines or white lines appear in images scanned using the automatic document feeder, clean the scanning area (the thin long glass next to the document glass). To clean this area, use the glass cleaner that is stored in the automatic document feeder. After using the glass cleaner, be sure to return it to its storage position.

#### Examples of lines in the image

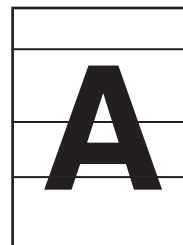

Black lines



White lines

- (1) Open the automatic document feeder and remove the glass cleaner.

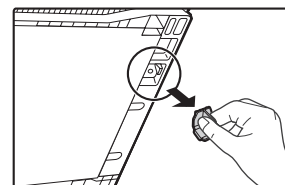

- (2) Clean the scanning area with the glass cleaner.

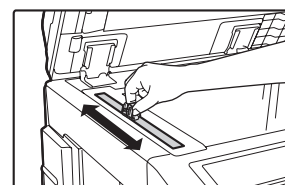

- (3) Replace the glass cleaner.

# CLEANING THE MAIN CHARGER OF THE PHOTOCONDUCTIVE DRUM

If black lines or colored lines appear even after you have cleaned the document glass and document feeder, use the charger cleaner to clean the main charger that charges the drum.

Figure 1

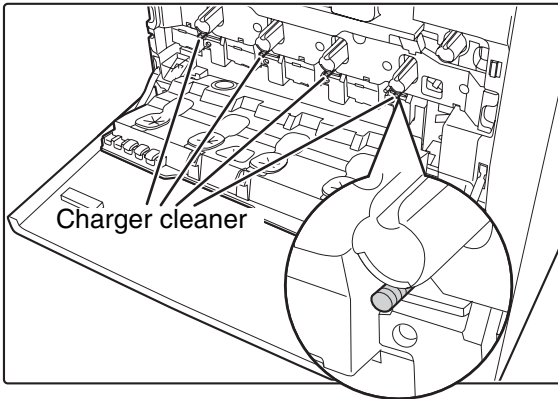
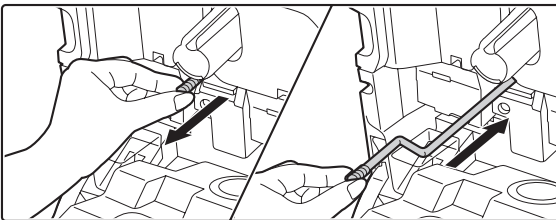

Figure 2



- (1) **Open the front cover.**
- (2) **Release the waste toner box lock and let the waste toner box fall forward.**  
For the steps to follow when letting the waste toner box fall forward, see step 3 of "[CLEANING THE LASER UNIT](#)" (page 54).
- (3) **Slowly pull out the green knob (charger cleaner).**  
Pull out the knob as shown in Figure 2.
- (4) **Once the green knob (charger cleaner) is pulled out, slowly push it back in.**  
Push the knob as shown in Figure 2.
- (5) **Repeat steps (3) and (4) for each of the other charger cleaners.**  
There are a total of 4 places to be cleaned in the machine as shown in Figure 1.
- (6) **Push the waste toner box into the machine.**  
Push the waste toner box firmly in until it clicks into place.
- (7) **Close the front cover.**



- If this does not solve the problem, pull the knob out and push it back in 2 more times.
- When pulling and pushing the knob to clean the charger, pull and push the knob slowly from one end to the other.

## CLEANING THE BYPASS FEED ROLLER

If paper misfeeds frequently occur when feeding postcards, envelopes, or thick paper through the bypass tray, wipe the surface of the feed roller with a clean soft cloth moistened with water or a neutral detergent.

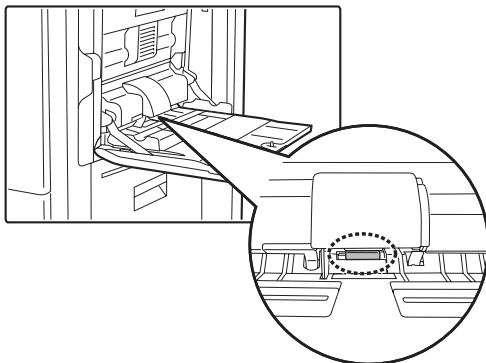

## CLEANING THE ORIGINAL FEED ROLLER

If lines or other dirt appear on the scanned original when the automatic document feeder is used, wipe the surface of the roller with a clean soft cloth moistened with water or a neutral detergent.

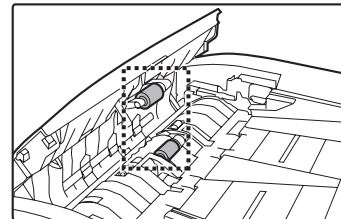

# CLEANING THE LASER UNIT

When the laser unit inside the machine becomes dirty, line-like color irregularities (colored lines) may appear in the print image. When the following conditions appear, clean the laser unit.

## Identifying lines (colored lines) caused by a dirty laser unit

- Colored lines always appear in the same place. (The lines are never black.)
- The colored lines are parallel to the direction of paper feeding.
- Colored lines appear not only when the copy function is used but also when the printer function is used. (The problem appears during both printing and copying.)

1

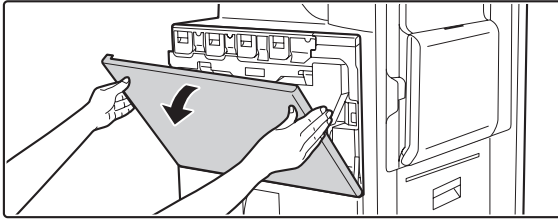

**Open the front cover.**

2

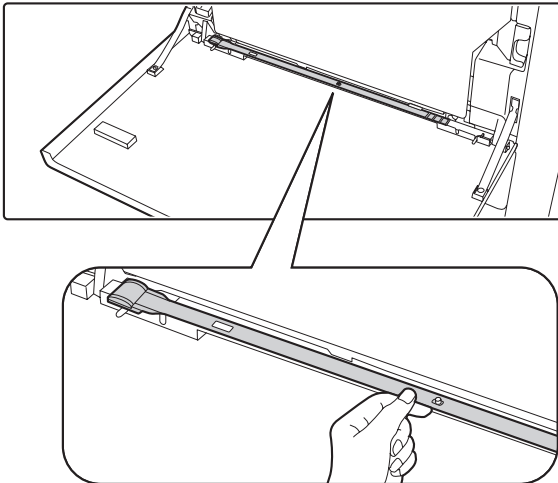

**Take out the cleaning tool for the laser unit.**

The cleaning tool is attached to the front cover.

3

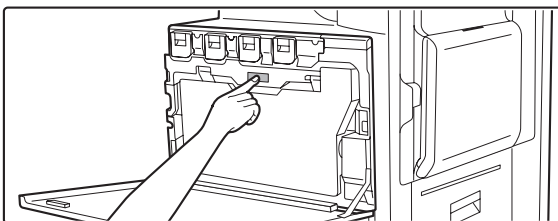

**Release the waste toner box.**

Press the waste toner box release button.

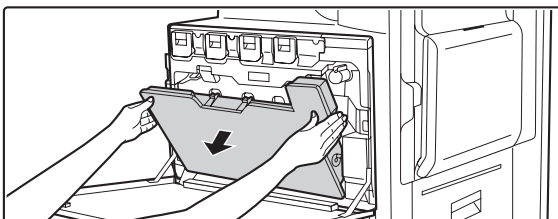

The waste toner box will fall forward as shown. Gently support the box with your hands as you let it fall forward as far as it will go.

4

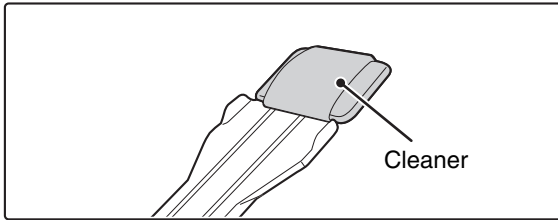

**Make sure that the cleaner at the tip of the cleaning tool is not dirty.**

If the cleaner is dirty, remove the cleaner and replace it with a clean one. For the procedure for replacing the cleaner, see steps 5 through 7. If the cleaner is not dirty, go to step 8.

5

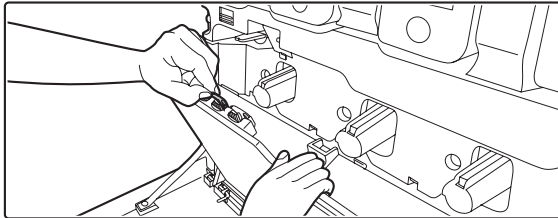

**Pull the replacement cleaner out of the waste toner box.**

The replacement cleaner is stored at the top of the waste toner box.

Grasp the end of the cleaner and pull it out of the waste toner box.

6

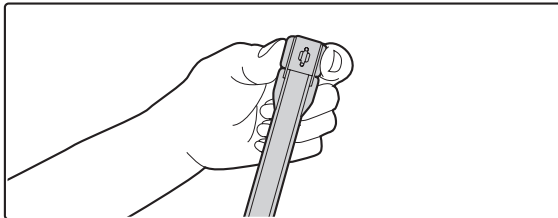

**Remove the dirty cleaner from the tip of the cleaning tool.**

(1) Firmly grasp the tool close to where the cleaner is attached.

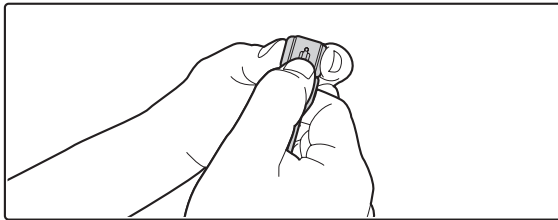

(2) Use your other hand to press down on the hook that secures the cleaner and remove the cleaner.



Do not return the removed cleaner to the top of the waste toner box.

7

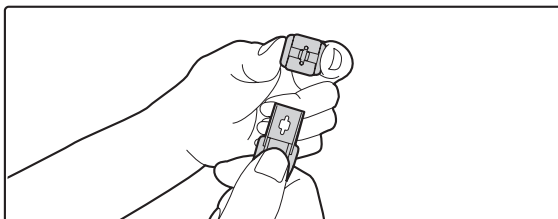

**Attach the new cleaner to the cleaning tool.**

(1) Align the cleaner hook with the attachment hole in the cleaning tool.

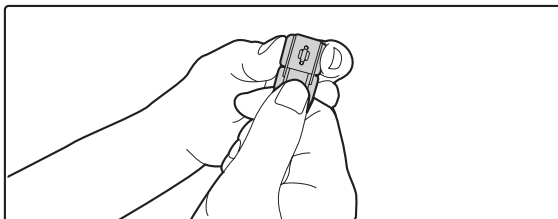

(2) Hold the cleaner firmly and push the cleaning tool in.



8

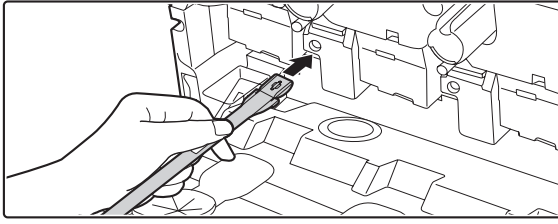

### Clean the laser unit.

- (1) **Point the cleaner down and slowly insert the tool into the hole that you wish to clean.**

Be sure to point the cleaner down.

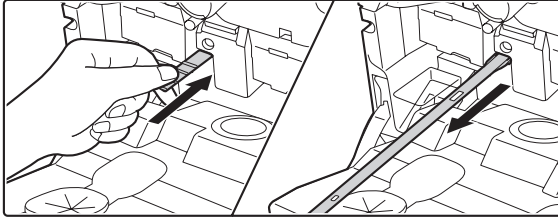

- (2) **Insert the cleaning tool all the way into the hole and then pull it back out.**

Pull the cleaning tool out until you feel the tip of the tool leave the cleaning surface of the laser unit.

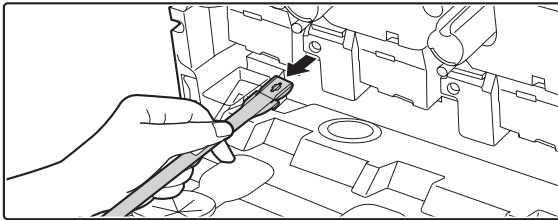

- (3) **Repeat step (2) two or three times and then remove the cleaning tool.**

9

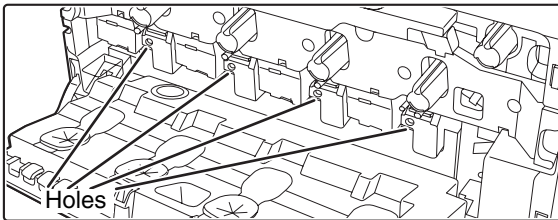

### Repeat step 8 to clean all holes in the laser unit (4 holes).

There are a total of 4 holes to be cleaned in the laser unit, including the hole cleaned in step 8. Clean all holes.

10

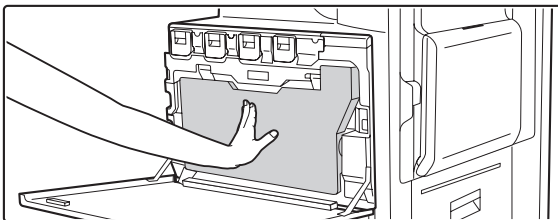

### Push the waste toner box into the machine.

Push the waste toner box firmly in until it clicks into place.

11

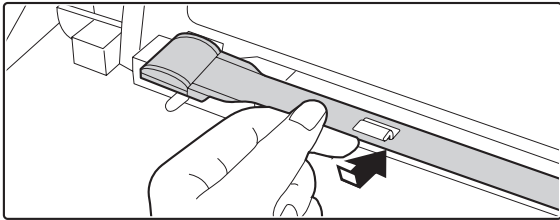
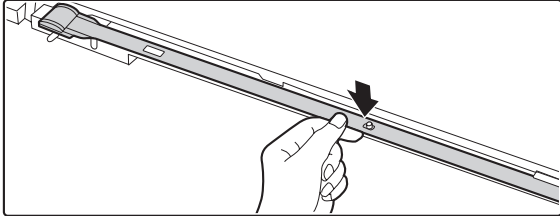
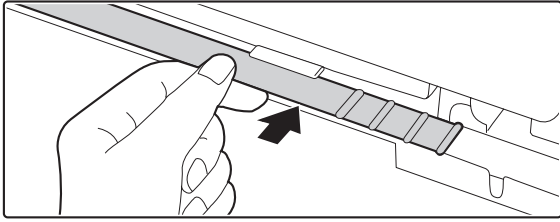

### Replace the cleaning tool.

- (1) Point the cleaner down and hook the end of the tool (the end without the cleaner) onto the holder on the right.
- (2) Align the holder with the hole in the center of the cleaning tool and slowly press down from above.
- (3) Fit the holder into the hole in the tip (the end with the cleaner) of the cleaning tool.

12

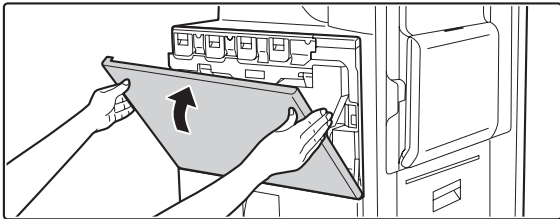

### Close the front cover.

# REPLACING THE TONER CARTRIDGES

When toner runs low, "[ ] [ ] [ ] [ ] Toner supply is low" appears in the display. It is recommended that you keep a set of new toner cartridges so that you can replace them quickly when toner runs out.

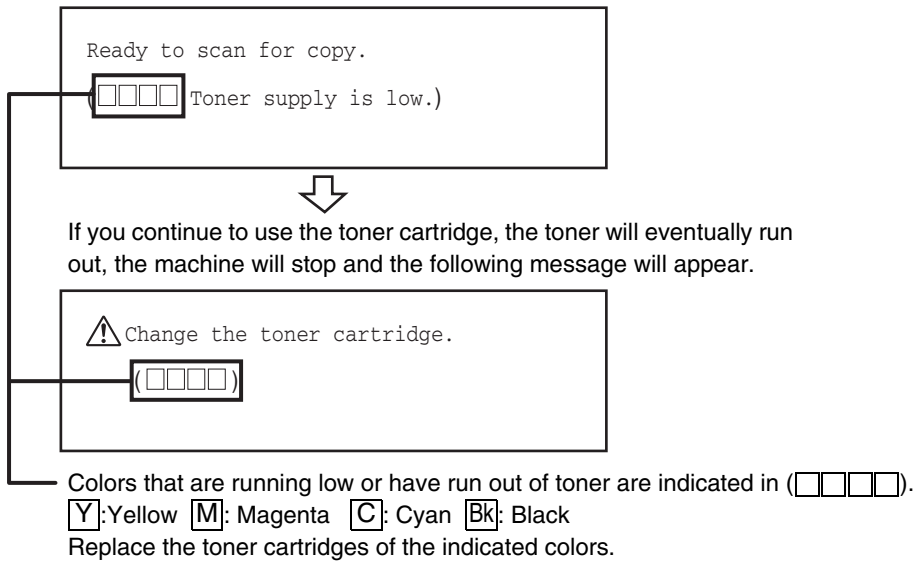

1

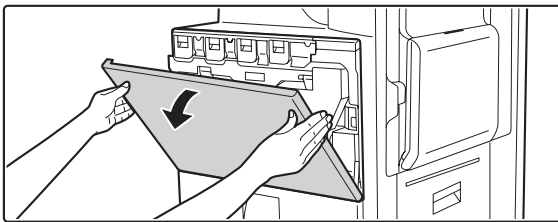

## Open the front cover.

### Locations of color toner cartridges

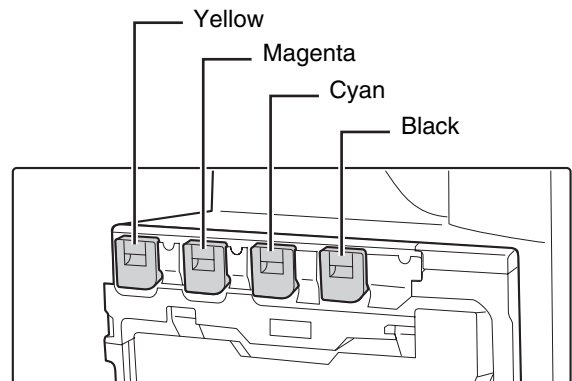

2

### Example: Replacing the yellow toner cartridge

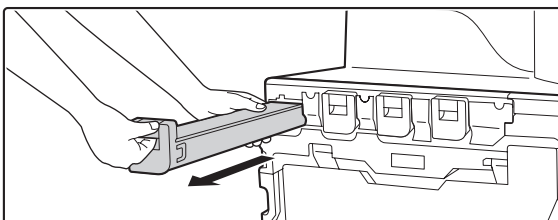

## Pull the toner cartridge toward you.

Raise the toner cartridge lever and gently pull the toner cartridge horizontally toward you. When pulling out the toner cartridge, pull it out gently. If the cartridge is pulled out abruptly, toner may spill out.

Hold the toner cartridge with both hands as shown and pull it out of the machine.

3

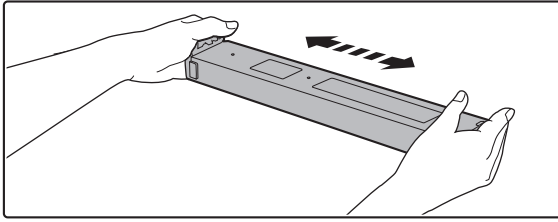

**Remove a new toner cartridge from its package and shake it horizontally five or six times.**

When shaking the toner cartridge, be sure to shake with the protective material inserted in the cartridge.

4

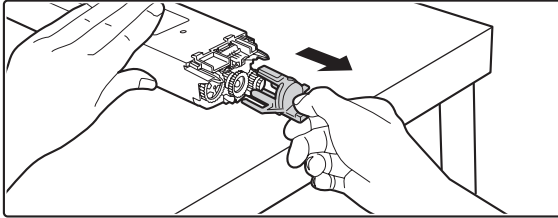

**Remove the protective material from the new toner cartridge.**

Hold the toner cartridge firmly while removing the protective material.

After the protective material has been removed, do not point the toner cartridge down or shake it.

5

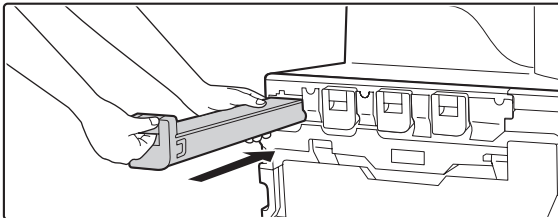

**Insert the new toner cartridge horizontally.**

Align the cartridge with the insert hole as shown and then push the cartridge in until it clicks into place.



A toner cartridge of a different color cannot be installed. Be sure to install a toner cartridge of the same color.

6

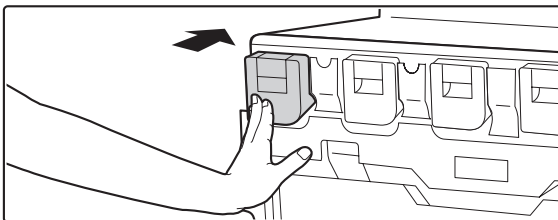

**Push the cartridge in until it locks securely in place.**

Push the cartridge firmly in until it clicks into place.

7

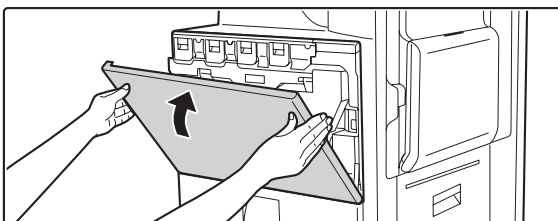

**Close the front cover.**

After the toner cartridge is replaced, the machine automatically enters image adjustment mode.

 **Caution**

- **Do not throw a toner cartridge into a fire. Toner may fly and cause burns.**
- **Store toner cartridges out of the reach of small children.**
- **If a toner cartridge other than a SHARP-recommended toner cartridge is used, the machine may not attain full quality and performance and there is a risk of damage to the machine. Be sure to use a SHARP-recommended toner cartridge.**



- If any one of the toner colors runs out (including black toner), color copying will not be possible. If Y, M, or C toner runs out but Bk toner remains, black and white copying will still be possible.
- Keep the used toner cartridge in a plastic bag (do not discard it). The service technician will collect the used toner cartridge at the time of maintenance.
- To view the approximate amount of toner remaining, hold down the [COPY] key during copying, printing, or when the machine is idle. The percentage of toner remaining will appear in the display while you hold down the key. When the percentage falls to "25-0%", obtain a new toner cartridge and keep it ready for replacement.

---

---

# REPLACING THE WASTE TONER BOX

The waste toner box collects residual toner that is produced during printing. When the used toner box is full, the display will show "Replace used toner container". Follow the procedure below to replace the used toner box.

1

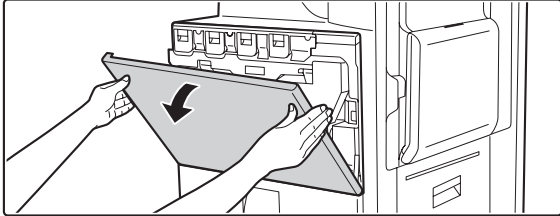

**Open the front cover.**

2

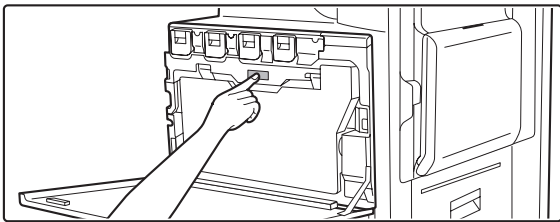

**Release the used waste toner box.**

Press the waste toner box release button.

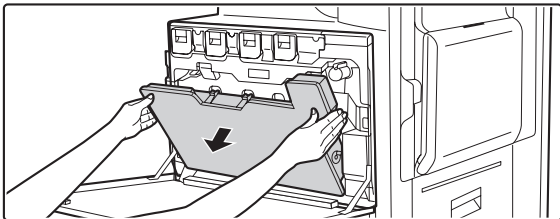

The waste toner box will fall forward as shown. Gently support the box with your hands as you let it fall forward as far as it will go.

3

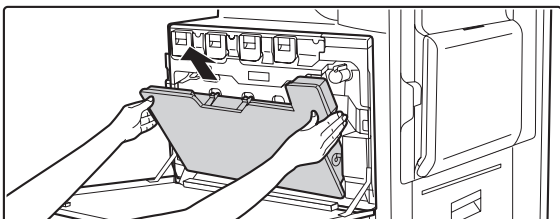

**Remove the waste toner box.**

Hold the box by both hands and lift it up slowly. If the waste toner box falls too far forward, it will not be possible to remove it. (Remove the box when it is at an angle of about 30 degrees.)

4

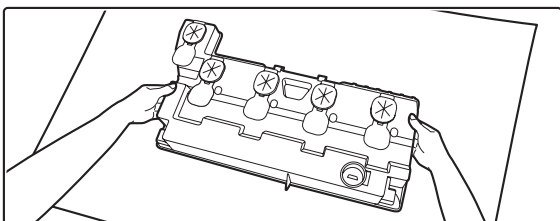

**Place the box on a flat surface.**

Place a sheet of newspaper on the surface before placing the box.



Do not point the holes down as used toner will spill out.

5

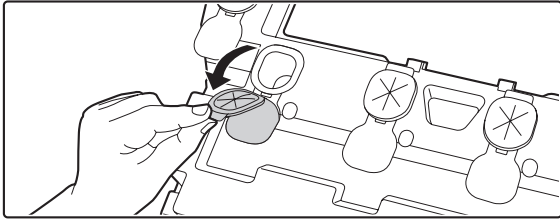

### Remove the seals around the holes.

Grasp the edge of each seal and pull it out toward you.



There are 5 seals. Remove all of the seals.

6

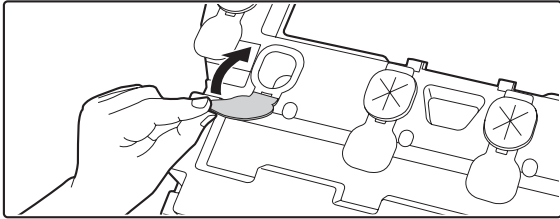

### Plug the holes.

Grasp the edge of each black seal and insert it into a hole in the box to plug the hole.

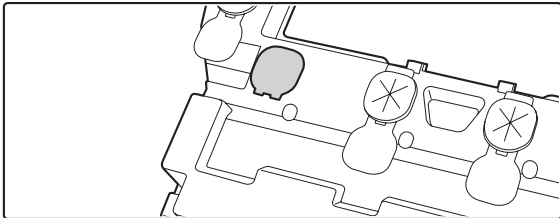

- There are 5 seals. Plug all of the holes.
- Do not discard the waste toner box. Place it in a plastic bag and keep it until your service technician comes to perform maintenance. Your service technician will collect the waste toner box.

7

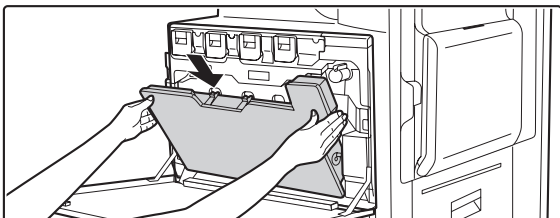

### Install the new waste toner box.

Insert the box from above at a slant. (The direction opposite to when you removed it.)

8

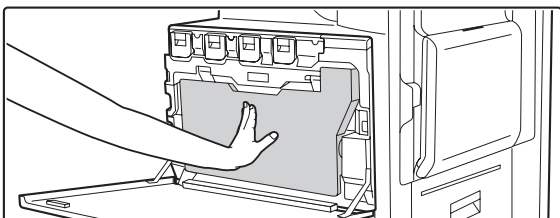

### Push the waste toner box into the machine.

Push the box in until it clicks into place.

9

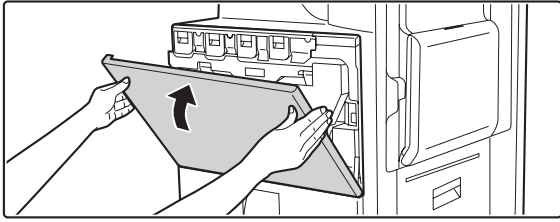

**Close the front cover.**

**⚠ Caution**

- Do not throw a waste toner box into a fire. Toner may fly and cause burns.
- Store waste toner box out of the reach of small children.



When replacing the waste toner box, be aware that it may soil your clothes or the place where you remove it.













# 6

# ENTERING TEXT

This chapter explains the text entry screen.

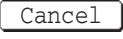
## FUNCTIONS OF THE MAIN KEYS

Key	Description
	This changes the text entry screen from the lower case screen to the upper case screen. The upper case screen will continue to appear until the [Caps] key is touched again so that it is no longer highlighted. The [Caps] key is convenient when you wish to enter all capital letters.
	This key temporarily changes the keys in the text entry screen to upper case when lower case letters appear, or to lower case when upper case letters appear. Touch a letter key after touching the [Shift] key to enter that letter. After the letter is entered, the [Shift] key will no longer be highlighted and the original text entry screen will appear. The [Shift] key is convenient when you only need to enter one upper case letter or one lower case letter, or when you need to enter one of the symbols assigned to the numeric keys. To cancel selection of the [Shift] key, touch the [Shift] key again. The [Shift] key will no longer be highlighted.
	Touch this key to enter a line break when entering the body text of an e-mail message.
	Touch this key to delete the characters to the left of the cursor one character at a time.
	Touch this key to change the entry mode. When this key is touched, the [Characters] key, [Symbol] key, and [Other Language] key appear. Touch one of the keys to select a different entry mode. <a href="#">"CHANGING THE ENTRY MODE"</a> (page 65)
	Touch this key to enter a space between letters.
	This temporarily changes the entry screen to the accented letter and symbol entry screen. Touch a letter key after touching the [AltGr] key to enter that letter. After the letter is entered, the [AltGr] key will no longer be highlighted and the original text entry screen will appear. To cancel selection of the [AltGr] key, touch the [AltGr] key again. The [AltGr] key will no longer be highlighted.
	These keys move the cursor left and right.
	These keys move the cursor to the line above or below the current line during entry of the body text of an e-mail message.
	Touch this key to return to the previous setting screen without entering text.
	Touch this key to enter the text that currently appears and return to the previous setting screen.

 "◀" in the text entry screen indicates how many characters can be entered. A number of characters greater than "◀" cannot be entered.

# CHANGING THE ENTRY MODE

Touch the [Mode] key to temporarily change the key layout of the keyboard to a different language. Select the desired key layout from the following keys.

## **[Characters] key**

Touch this key to select character entry mode.

## **[Symbol] key**

Touch this key to select symbol entry mode. Symbol mode is used to enter symbols and accented letters.

## **[Other Language] key**

Touch this key to temporarily change the key layout of character entry mode to a different language. Select the key layout that you wish to use.



The key layouts that can be selected vary depending on the language selected in "Display Language Setting" in the system settings (administrator).

# ENTERING TEXT FROM AN EXTERNAL KEYBOARD

An external keyboard can only be used as a alternative for the text entry screen that appears in the machine's touch panel.

The layout of the keys in the text entry screen in the touch panel differs slightly from the layout of the keys on the external keyboard.

Use a SHARP-recommended external keyboard.

For the recommended keyboards, please contact your dealer or nearest SHARP Service Department.

**SHARP**<sup>®</sup>

MODEL: MX-2300N  
MX-2700N

# System Settings Guide

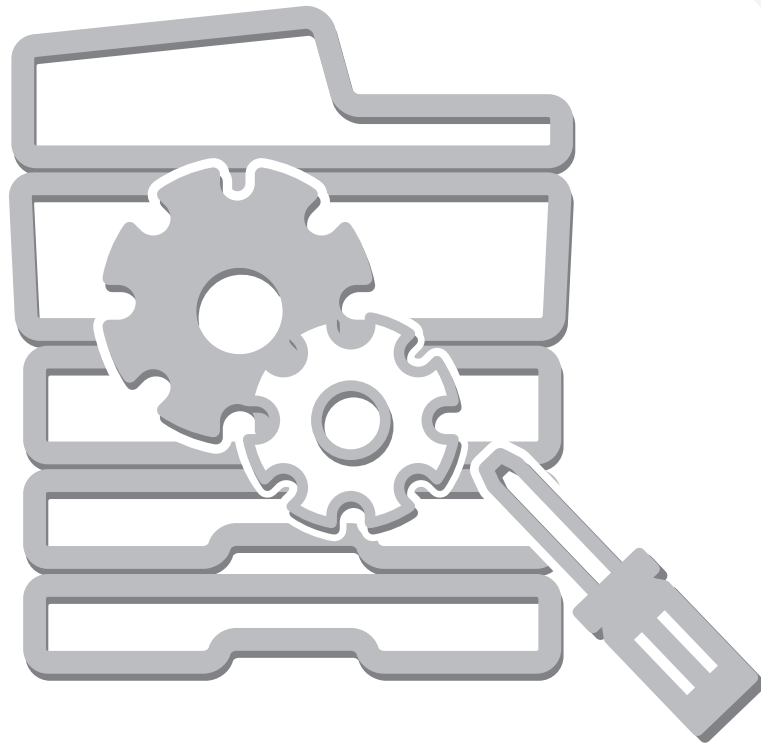

---

---

# Table of Contents

About This Manual .....	2
System Settings .....	4

## 1 SYSTEM SETTINGS (GENERAL)

Accessing the System Settings (General) .....	5
System Settings (General) List .....	9
Total Count .....	15
Default Settings .....	17
List Print (User) .....	20
Paper Tray Settings .....	24
Address Control .....	30
Fax Data Receive/Forward .....	44
Printer Condition Settings .....	46
Document Filing Control .....	52
USB-Device Check .....	57
User Control .....	58

## 2 SYSTEM SETTINGS (ADMINISTRATOR)

Accessing the System Settings (Administrator) ..	60
System Settings (Administrator) List .....	64
User Control .....	80
Energy Save .....	89
Operation Settings .....	90
Device Control .....	93
Copy Settings .....	96
Network Settings .....	100
Printer Settings .....	101
Image Send Settings .....	104
Document Filing Settings .....	114
List Print (Administrator) .....	116
Security Settings .....	117
Enable/Disable Settings .....	118
Change Administrator Password .....	122
Product Key .....	123
Storing/Calling of System Settings .....	124

---

---

# About This Manual

## Please note

---

- Considerable care has been taken in preparing this manual. If you have any comments or concerns about the manual, please contact your nearest SHARP Service Department.
- This product has undergone strict quality control and inspection procedures. In the unlikely event that a defect or other problem is discovered, please contact your dealer or nearest SHARP Service Department.
- Aside from instances provided for by law, SHARP is not responsible for failures occurring during the use of the product or its options, or failures due to incorrect operation of the product and its options, or other failures, or for any damage that occurs due to use of the product.

## Warning

---

- Reproduction, adaptation or translation of the contents of the manual without prior written permission is prohibited, except as allowed under copyright laws.
- All information in this manual is subject to change without notice.

## Illustrations and the operation panel and touch panel shown in this manual

---

The peripheral devices are generally optional, however, some models include certain peripheral devices as standard equipment. The explanations in this manual assume that a right tray and stand/2 x 500 sheet paper drawer are installed.

To further explain certain functions and uses, some explanations assume that additional peripheral devices are installed.

The display screens, messages, and key names shown in the manual may differ from those on the actual machine due to product improvements and modifications.
---

# Manuals Provided with the Machine

Printed manuals and manuals stored in PDF format on the machine's hard drive are provided with the machine. When using the machine, read the appropriate manual for the feature you are using.

## Printed manuals

Manual name	Contents
<b>Safety Guide</b>	This manual contains instructions for using the machine safely and lists the specifications of the machine and its peripheral devices.
<b>Software Setup Guide</b>	This manual explains how to install the software and configure settings to use the machine as a printer or scanner.
<b>Quick Start Guide</b>	This manual provides easy-to-understand explanations of all the functions of the machine in a single volume. Detailed explanations of each of the functions can be found in the manuals in PDF format.
<b>Troubleshooting</b>	This manual explains how to remove paper misfeeds and provides answers to frequently asked questions regarding the operation of the machine in each mode. Refer to this manual when you have difficulty using the machine.
<b>Facsimile Quick Reference Guide</b>	This manual explains the basic procedures for using the fax function of the machine, and provides an overview of the features of the fax function, troubleshooting procedures, and specifications. For detailed information on using the fax function and the system settings for fax, see the "Facsimile Guide" in PDF format.



## Operation manuals in PDF format

The manuals in PDF format provide detailed explanations of the procedures for using the machine in each mode. To view the PDF manuals, download them from the hard drive in the machine. The procedure for downloading the manuals is explained in "How to download the manuals in PDF format" in the Quick Start Guide.

Manual name	Contents
<b>User's Guide</b>	This manual provides information, such as basic operation procedures, how to load paper, and machine maintenance.
<b>Copier Guide</b>	This manual provides detailed explanations of the procedures for using the copy function.
<b>Printer Guide</b>	This manual provides detailed explanations of the procedures for using the printer function.
<b>Facsimile Guide</b>	This manual provides detailed explanations of the procedures for using the fax function and the "System Settings" that are related to fax.
<b>Scanner Guide</b>	This manual provides detailed explanations of the procedures for using the scanner function and the Internet fax function.
<b>Document Filing Guide</b>	This manual provides detailed explanations of the procedures for using the document filing function. The document filing function allows you to save the document data of a copy or fax job, or the data of a print job, as a file on the machine's hard drive. The file can be called up as needed.
<b>System Settings Guide (This manual)</b>	This manual explains the "System Settings", which are used to configure a variety of parameters to suit the aims and the needs of your workplace. Current settings can be displayed or printed out from the "System Settings".

## Icons used in the manuals

The icons in the manuals indicate the following types of information:

	This alerts you to a situation where there is a risk of machine damage or failure.
	This provides a supplemental explanation of a function or procedure.
	This explains how to cancel or correct an operation.

# System Settings

The system settings are used to configure a variety of parameters to suit the aims and the needs of your workplace. The system settings are also used to display or print out the current settings and status of the machine. The system settings allow you to make the machine easier to use.

The system settings consist of settings for use by general users, and settings that can only be configured by an administrator of the machine. These two groups of settings are distinguished in this manual as follows.

System Settings (General)	System Settings (Administrator) *Login Required
<p>System settings that can be configured by general users (including the administrator). For example, the following settings can be configured.</p> <ul style="list-style-type: none"> <li>• Date and time settings</li> <li>• Paper tray settings (paper size and paper type)</li> <li>• Storing destinations for the fax and scanner functions.</li> <li>• Settings related to the printer function</li> <li>• Storing, editing, and deleting folders for the document filing function.</li> <li>• Displaying the number of pages printed, scanned, and faxed.</li> </ul> <p>For more information, see "<a href="#">1. SYSTEM SETTINGS (GENERAL)</a>" (page 5).</p>	<p>System settings that can be configured by the administrator. To configure these settings, login as an administrator is required. For example, the following settings can be configured.</p> <ul style="list-style-type: none"> <li>• Storing users of the machine.</li> <li>• Energy save settings</li> <li>• Settings related to the operation panel</li> <li>• Settings for peripheral devices installed on the machine.</li> <li>• Settings related to the copy function</li> <li>• Network connection settings</li> <li>• Transmission/reception settings for faxes and scanned images</li> <li>• Advanced settings for the document filing function</li> </ul> <p>For more information, see "<a href="#">2. SYSTEM SETTINGS (ADMINISTRATOR)</a>" (page 60).</p>
<b>Settings for general users</b>	<b>Settings for administrators</b>



• **Administrator password**

To maintain security, the administrator of the machine should promptly change the password after the machine is purchased. (For the factory default administrator password, see "TO THE ADMINISTRATOR OF THE MACHINE" in the Safety Guide.) To change the password, see "[Change Administrator Password](#)" (page 122) in the system settings (administrator).

\*To ensure a high level of security, change the password at regular intervals.

- The above groupings of "General" and "Administrator" are used as a convenient means of clarifying the functions of the settings. These groupings do not appear in the touch panel.
- For information on system settings for fax, see "11. SYSTEM SETTINGS FOR FAX" in the Facsimile Guide.
- The Web pages can also be used to configure the system settings. To configure the system settings from the Web pages, click [System Settings] in the Web page menu.

# 1

# SYSTEM SETTINGS (GENERAL)

This chapter describes the system settings that can be configured by general users of the machine.

## Accessing the System Settings (General)

### When User Authentication is not Enabled

Make sure that the machine is in the standby state and then press the [SYSTEM SETTINGS] key on the operation panel.

#### Operation panel

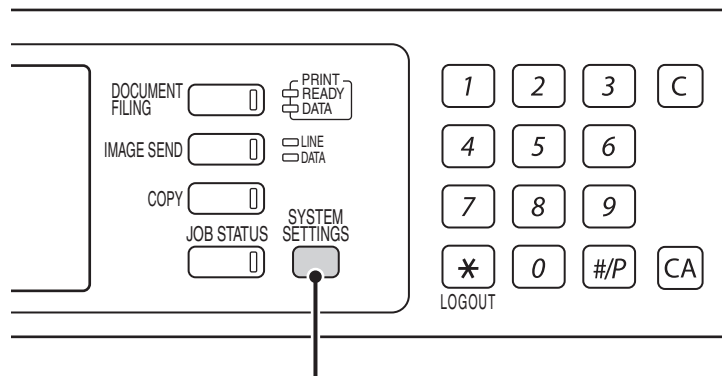

[SYSTEM SETTINGS] key

When the [SYSTEM SETTINGS] key is pressed, the following menu screen appears on the touch panel. Touch the item in this screen that you wish to configure. For detailed explanations of each of the settings, see the following pages of this chapter.

#### System settings screen (factory default state)

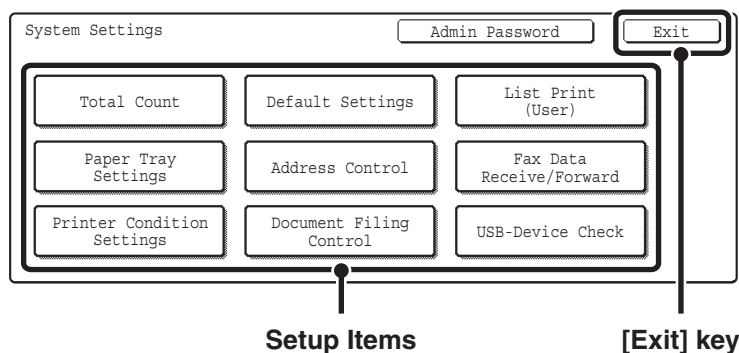

Setup Items

[Exit] key



- To quit the system settings, touch the [Exit] key in the top right corner of the screen.
- User authentication is initially disabled (factory default setting).



# When User Authentication is Enabled

When "User Authentication Setting" (page 80) is enabled, login is required in the login screen before the machine can be used.

The login screen varies depending on the settings configured in "Authentication Method Setting" (page 80). If one of the following login screens appears, log in using the user information provided by the administrator of the machine. You can then use the system settings.

Login name and password

Login name, password and E-mail address

User number



- Check with your administrator for the user information that is required to log in.
- When auto login is enabled, the login screen will not appear.

## Login by login name and password

When authentication is by login name/password/E-mail address, your E-mail address must also be entered in the following procedure. Touch the [E-mail Address] key and enter your e-mail address, which is stored on the LDAP server, in same way as you enter the password. When finished, touch the [OK] key. (If you select a user whose E-mail address is stored in the machine, the e-mail address is automatically entered when the user is selected.)

1

Touch the [Login Name] key.



You can touch the  key and enter a user registration number (see "User Registration" (page 81)) with the numeric keys to directly select the corresponding user.

2

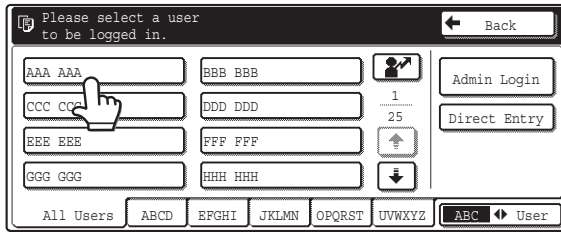

## Select the user.



- You can touch the  key and enter a user registration number (see "User Registration" (page 81)) with the numeric keys to directly select the corresponding user.
- To specify a user not stored in the machine directly using the LDAP server, touch the [Direct Entry] key, enter the login name that is stored on the LDAP server, and touch the [OK] key. (When LDAP is enabled.)

3



## Enter a password.

- (1) Touch the [Password] key.
- (2) Enter a password on the text entry screen that will appear.

When logging in locally to the machine, enter your password that was stored as explained in "User Registration" (page 81).

If authentication is to the LDAP server, enter your password that is stored on the LDAP server.

For the procedure for entering text, see "6. ENTERING TEXT" in the User's Guide.



- If a password has not been established, this step is not necessary. Go to step 4.

4

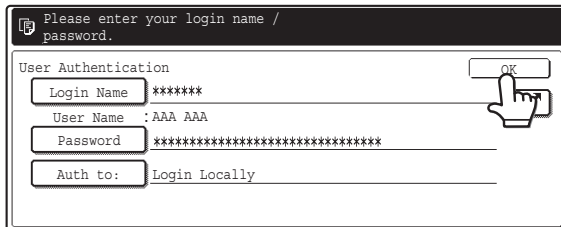

## Touch the [OK] key.



- When a user is selected that is stored on the machine, [Auth to:] is entered. To enter your login name directly or change the login destination, touch the [Auth to:] key. The following screen appears when the key is touched. Select the desired key and touch the [OK] key.

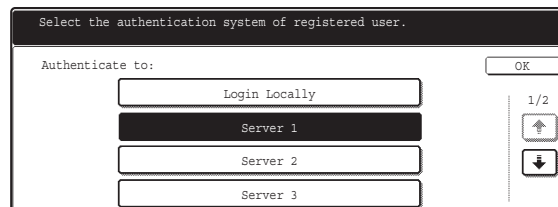

- "Authenticate to" cannot be changed when an LDAP server has not been stored.
- Users for which the authentication destination is LDAP cannot select "Login Locally".
- This completes the login procedure. After login, the system settings can be used. For the procedure following login, see "When User Authentication is not Enabled" (page 5).

# Login by user number

1

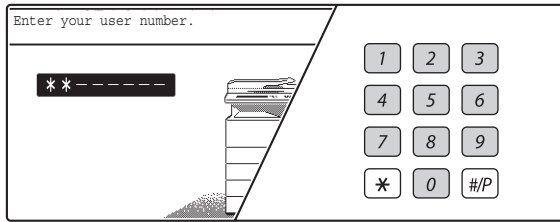

**Enter your user number with the numeric keys.**

Each entered digit will be displayed as "\*".

2

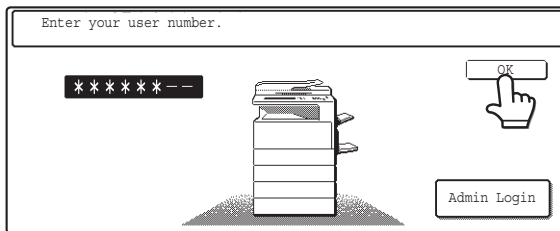

**Touch the [OK] key.**



- When a user number is set to a 8-digit number, this step is not necessary. (When an user number is entered, login will take place automatically.)
- This completes the login procedure. After login, the system settings can be used. For the procedure following login, see "[When User Authentication is not Enabled](#)" (page 5).



- To configure and store LDAP settings, click [Network Settings] and then [LDAP Settings] in the Web page menu. (Administrator rights are required.)
- When Auto Clear activates, logout automatically takes place.
- **To logout...**  
Press the [LOGOUT] key (). (Except when entering a fax number.)

# System Settings (General) List

When the system settings are accessed with general rights, the following items appear. The factory default settings for each item are also shown. For items that can only be accessed with administrator rights, see "[System Settings \(Administrator\) List](#)" (page 64).

 Depending on the machine specifications and peripheral devices installed, it may not be possible to use some settings.

Item	Factory default setting	Page
■ <b>Total Count</b>		15
● Job Count	–	15
● Device Count	–	16
■ <b>Default Settings</b>		17
● Display Contrast	(Set to the center value)	17
● Clock		18
▶ Date Format	[MM/DD/YYYY], [/], [Last], [12-Hour]	
▶ Daylight Saving Time Setting	Disable	
● Keyboard Select	English(US)	19
■ <b>List Print (User)</b>		20
● All Custom Setting List	–	20
● Printer Test Page		21
▶ PCL Symbol Set List	–	
▶ PCL Internal Font List	–	
▶ PCL Extended Font List	–	
▶ PS Font List*1	–	
▶ PS Extended Font List*1	–	
▶ NIC Page	–	
● Sending Address List		22
▶ Individual List	–	
▶ Group List	–	
▶ Program List	–	
▶ Memory Box List	–	
▶ All Sending Address List	–	
● Document Filing Folder List	–	23

Item	Factory default setting	Page
■ <b>Paper Tray Settings</b>		24
● <b>Tray Settings</b>		24
▶ Tray 1	Plain, 8-1/2" x 11"	
▶ Tray 2	Plain, 11" x 17"	
▶ Tray 3	Varies depending on the machine configuration	
▶ Tray 4		
▶ Tray 5		
▶ Bypass Tray	Plain, Auto-Inch	
● <b>Paper Type Registration</b>		28
▶ User Type 1	–	
▶ User Type 2	–	
▶ User Type 3	–	
▶ User Type 4	–	
▶ User Type 5	–	
▶ User Type 6	–	
▶ User Type 7	–	
● <b>Auto Tray Switching</b>	Enable	29
■ <b>Address Control</b>		30
● <b>Direct Address / Program</b>		30
▶ <b>Individual</b>		
◆ <b>E-mail</b>		
• Search Number	–	
• Name	–	
• Initial	–	
• Index	–	
• Address	–	
• Key Name	–	
• File Format	–	

Item	Factory default setting	Page
◆ Internet Fax*2		
• Search Number	–	
• Name	–	
• Initial	–	
• Index	–	30
• Address	–	
• Key Name	–	
• Compression	–	
• I-Fax Report	–	
▶ Group		
◆ Search Number	–	
◆ Group Name	–	
◆ Initial	–	34
◆ Index	–	
◆ Address	–	
◆ Key Name	–	
▶ Program		
◆ Program Name	–	
◆ Settings		
• Address	–	38
• Resolution	–	
• Exposure	–	
• Special Modes	–	
▶ <a href="#">Modify/Delete</a>	–	40
● Custom Index		
▶ User 1	–	
▶ User 2	–	
▶ User 3	–	43
▶ User 4	–	
▶ User 5	–	
▶ User 6	–	
■ <a href="#">Fax Data Receive/Forward</a>		44
● <a href="#">Internet Fax Manual Reception*2</a>	–	
▶ Reception Start	–	44
▶ Manual Reception Key in Initial Screen	Enable	
● <a href="#">Internet Fax Data Forward*2</a>	–	45

Item	Factory default setting	Page
■ <b>Printer Condition Settings</b>		46
● <b>Printer Default Settings</b>		46
▶ Copies	1	
▶ Orientation	Portrait	
▶ Default Paper Size	8-1/2" x 11"	
▶ Default Output Tray*3	Varies depending on the machine configuration	
▶ Default Paper Type	Plain Paper	
▶ Line Thickness	5	
▶ 2-Sided Print	1-Sided	
▶ Color Mode	B/W	
▶ N-Up Print	1-Up	
● <b>PCL Settings</b>		49
▶ PCL Symbol Set Setting	3. PC-8	
▶ PCL Font Setting	Internal Font, 0. Courier	
▶ PCL Line Feed Code	0. CR=CR:LF=LF:FF=FF	
▶ Wide A4	Disable	
● <b>Postscript Settings*1</b>		51
▶ Print PS Errors	Disable	
■ <b>Document Filing Control</b>		52
● <b>Custom Folder Registration</b>		52
▶ Folder Name	–	
▶ Initial	–	
▶ Password	–	
▶ User Name	–	
● <b>Modify/Delete Custom Folder</b>	–	55
■ <b>USB-Device Check</b>	–	57
■ <b>User Control*4</b>		58
● <b>Modify User Information</b>	–	58

The following items are explained in "11. SYSTEM SETTINGS FOR FAX" in the Facsimile Guide.

Item	Factory default setting
<b>■ Address Control</b>	
● Direct Address/Program	
▶ Individual	
◆ Fax*5	
• Search Number	-
• Name	-
• Initial	-
• Index	-
• Fax No.	-
• Key Name	-
• Mode	-
● F-Code Memory Box*5	
▶ Store	
◆ Polling Memory	
• Box Name	-
• Sub Address	-
◆ Confidential	
• Box Name	-
• Sub Address	-
• Print PIN	-
◆ Relay Broadcast	
• Box Name	-
• Sub Address	-
• Recipients	-
▶ Modify/Delete	
◆ Polling Memory	-
◆ Confidential	-
◆ Relay Broadcast	-



Item	Factory default setting
<b>■ Fax Data Receive/Forward</b>	
● Fax Receive Settings*5	Auto Reception
▶ Multiple Set Print	Disable
▶ Staple*6	Disable
● Fax Data Forward*5	—

\*1 When the PS3 expansion kit is installed.

\*2 When the Internet fax expansion kit is installed.

\*3 When a right tray is installed.

\*4 When user authentication is enabled and a user without the authority to configure the system settings (administrator) has logged in. (Excluding factory stored users.)

\*5 When the facsimile expansion kit is installed.

\*6 When a saddle stitch finisher or finisher is installed.

# Total Count



The items displayed (or printed) will vary depending on the machine specifications and peripheral devices installed.

## Job Count

This displays or prints out the counts of all jobs.

1



Press the [SYSTEM SETTINGS] key.

2

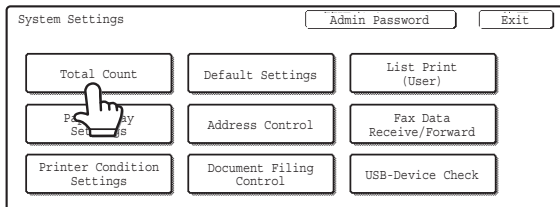

Touch the [Total Count] key.

3

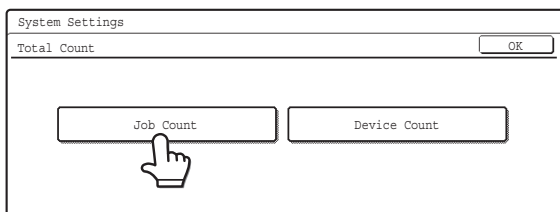

Touch the [Job Count] key.

4

Job Count	B/W	F. Color	2 Color	S. Color
Total Count	12,147,369	36,914,700	39,800	72,568
Copies	3,123,147	21,020,030	39,800	72,568
Prints	3,246,810	15,894,670		
Other Prints	4,680,100			
Fax Receive	1,097,312			

Check the job counts.

- (1) If necessary, switch through the screens with the keys to display the desired item.
- (2) To print the counts, touch the [Print] key.  
A message screen appears and printing begins.



- 11" x 17" (A3) size paper is counted as two sheets.
- Each sheet of paper used for automatic two-sided copying is counted as two pages (11" x 17" (A3) paper is counted as four pages).
- An entered paper size of 5-1/8" (384 mm) or larger is counted as two pages. (Four pages when two-sided copying is used.)
- Pages printed directly from the machine such as list prints are included in the "Other Prints" count.



### To cancel printing...

Touch the [Cancel] key in the message screen that appears after you touch the [Print] key.

# Device Count

This is used to display or print the counts of the peripheral devices installed on the machine.

1



Press the [SYSTEM SETTINGS] key.

2

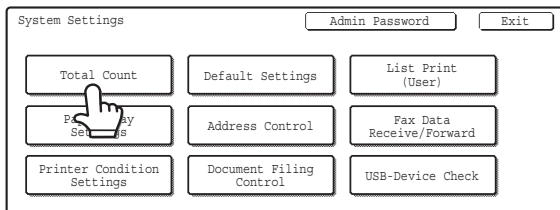

Touch the [Total Count] key.

3

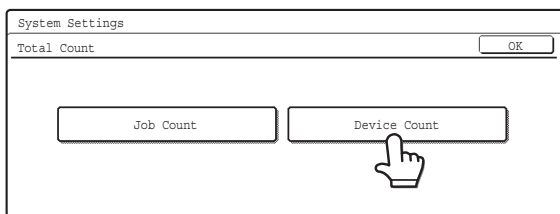

Touch the [Device Count] key.

4

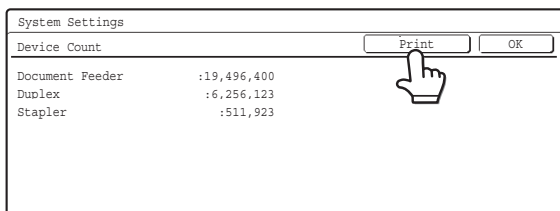

Check the device counts.

To print the counts, touch the [Print] key. A message screen appears and printing begins.



• **Document feeder**

Each sheet is counted as two pages when two-sided scanning is performed.

• **Stapler (when a finisher or saddle stitch finisher is installed)**

Two-position stapling and pamphlet stapling are counted as "2".



**To cancel printing...**

Touch the [Cancel] key in the message screen that appears after you touch the [Print] key.

---

---

# Default Settings

## Display Contrast

Use this to adjust the display to make it easier to view.

1



Press the [SYSTEM SETTINGS] key.

2

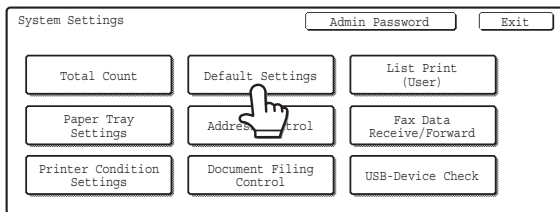

Touch the [Default Settings] key.

3

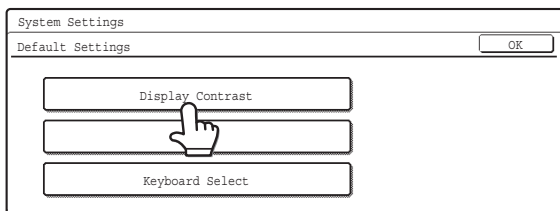

Touch the [Display Contrast] key.

4

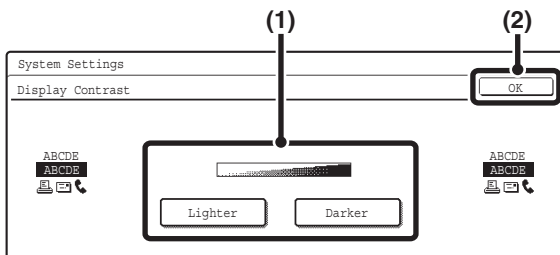

Adjust the brightness.

- (1) Touch the [Lighter] key or the [Darker] key.  
The [Lighter] key lightens the display and the [Darker] key darkens the display.
- (2) Touch the [OK] key.

# Clock

Use this to set the date and time in the machine's built-in clock.

1



Press the [SYSTEM SETTINGS] key.

2

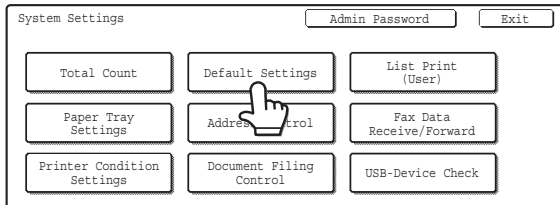

Touch the [Default Settings] key.

3

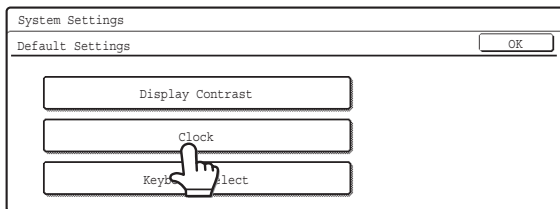

Touch the [Clock] key.

4

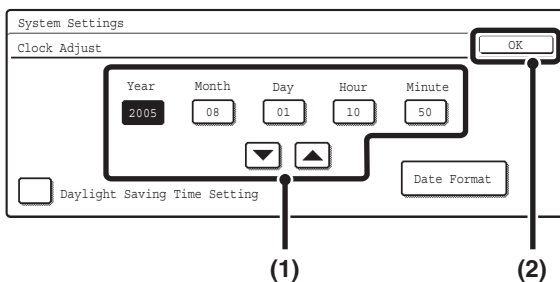

Adjust the date and time.

- (1) Touch the [Year], [Month], [Day], [Hour], and/or [Minute] keys and use the keys to set the current date and time.
- (2) Touch the [OK] key.



- To change the format of the date, touch the [Date Format] key. The following screen will appear.

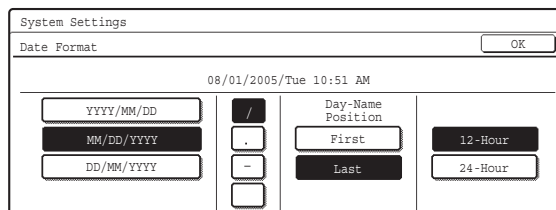

In the date format screen, select the order of the year, month, and day (MM/DD/YYYY), the separator character, the position of the day, and 12-hour or 24-hour format.

Select each item and touch the [OK] key.

- If you want the clock to change automatically at the beginning and end of daylight saving time, select the [Daylight Saving Time Setting] checkbox . When this function is used, the time changes at the beginning and end of daylight saving time as follows:  
Standard time → Daylight saving time: First Sunday in April, 2:00 → 3:00 AM  
Daylight saving time → Standard time: Last Sunday in October, 2:00 → 1:00 AM



If "Disabling of Clock Adjustment" (page 91) has been enabled in the system settings (administrator), the date and time cannot be set.

# Keyboard Select

The layout of the keyboard that appears in text entry screens can be changed.

**1**

SYSTEM  
SETTINGS



**Press the [SYSTEM SETTINGS] key.**

---

**2**

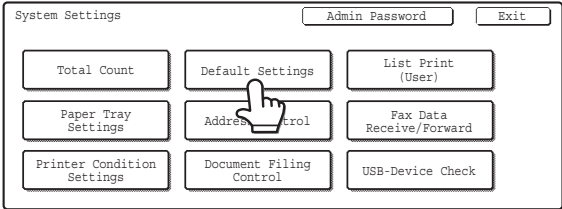

**Touch the [Default Settings] key.**

---

**3**

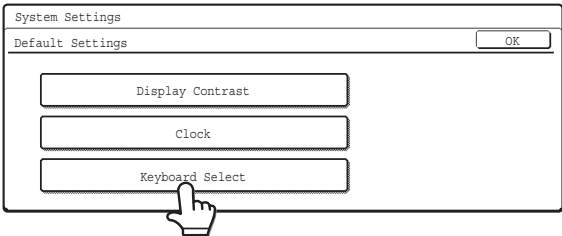

**Touch the [Keyboard Select] key.**

---

**4**

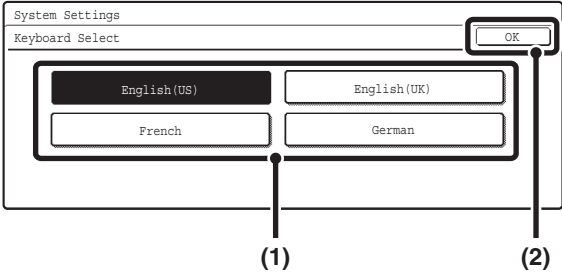

**Select the keyboard.**  
**(1) Touch the desired display language.**  
**(2) Touch the [OK] key.**



The keyboards that appear and the factory default keyboard vary by country and region.

---

---

# List Print (User)

A test page can be printed to check the machine settings.

## All Custom Setting List

This list shows all custom settings, including the hardware status, software status, printer condition settings, system settings, and total counts.

1



Press the [SYSTEM SETTINGS] key.

2

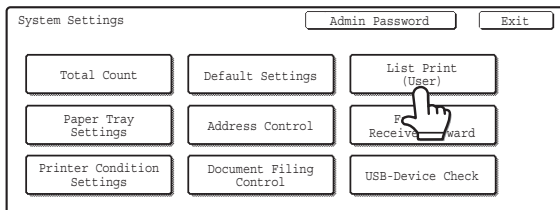

Touch the [List Print (User)] key.

3

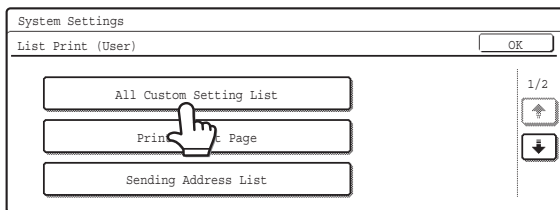

Touch the [All Custom Setting List] key.

Printing begins.



**To cancel printing...**

Touch the [Cancel] key in the message screen that appears after you touch the [All Custom Setting List] key.

# Printer Test Page

This is used to print the PCL Symbol Set List, various font lists, and the NIC page (network interface settings, etc.).

1



Press the [SYSTEM SETTINGS] key.

2

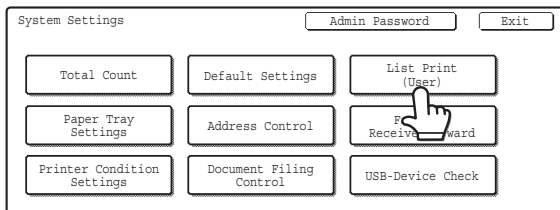

Touch the [List Print (User)] key.

3

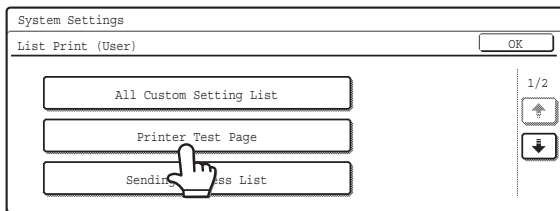

Touch the [Printer Test Page] key.

4

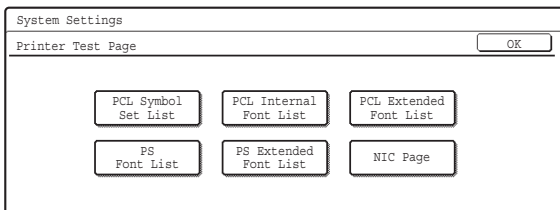

Touch the list that you wish to print.

Printing begins.



The items that appear will vary depending on the functions that have been added to the machine.



### To cancel printing...

Touch the [Cancel] key in the message screen that appears after you touch one of the keys.



If "[Prohibit Test Page Printing](#)" (page 101) has been enabled in the system settings (administrator), it will not be possible to print test pages.



# Sending Address List

Use this to print the Individual List, the Group List, the Program List, the Memory Box List, and the All Sending Address List.

1



Press the [SYSTEM SETTINGS] key.

2

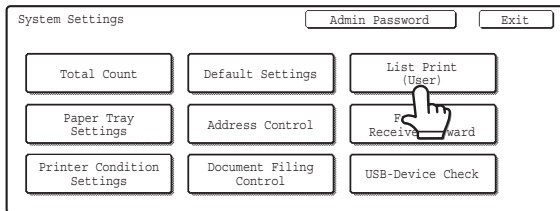

Touch the [List Print (User)] key.

3

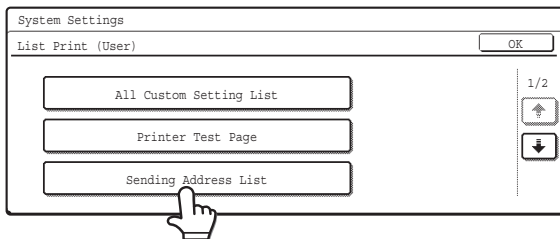

Touch the [Sending Address List] key.

4

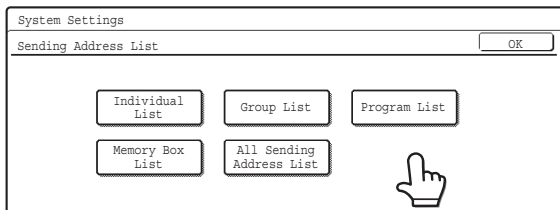

Touch the list that you wish to print.

A message screen appears and printing begins.



## To cancel printing...

Touch the [Cancel] key in the message screen that appears after you touch one of the keys.

# Document Filing Folder List

This shows the folder names for document filing.

1



Press the [SYSTEM SETTINGS] key.

2

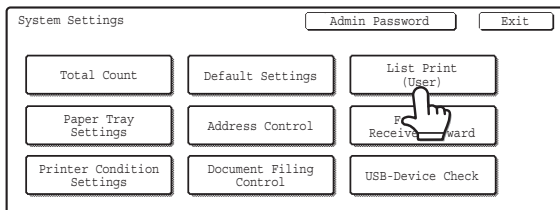

Touch the [List Print (User)] key.

3

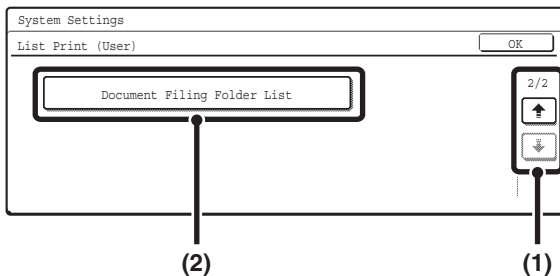

Print the Document Filing Folder List.

- (1) Touch the keys to switch through the screens.
- (2) Touch the [Document Filing Folder List] key.

A message screen appears and printing begins.



## To cancel printing...

Touch the [Cancel] key in the message screen that appears after you touch the [Document Filing Folder List] key.

---

---

# Paper Tray Settings

## Tray Settings

This is used to specify the paper type, paper size, and functions used for each paper tray.

1



Press the [SYSTEM SETTINGS] key.

2

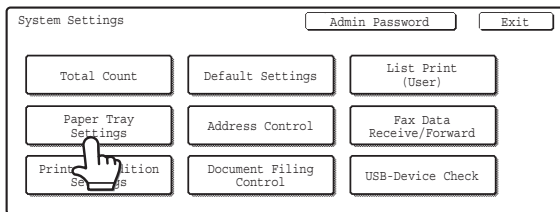

Touch the [Paper Tray Settings] key.

3

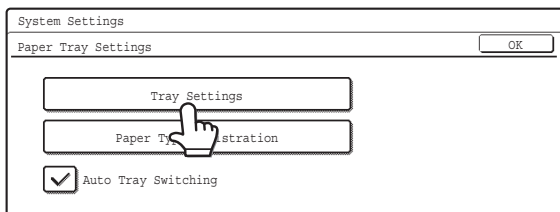

Touch the [Tray Settings] key.

4

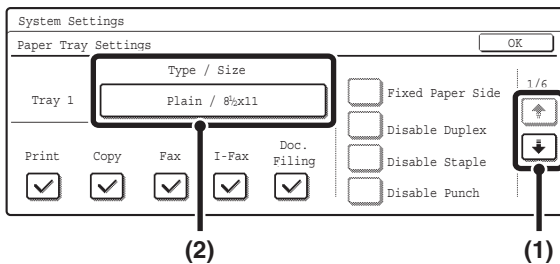

Select the tray that you wish to configure.

(1) If needed, use the keys to switch through the trays.

(2) Touch the [Type/Size] key.

## Example: Tray 1 is selected

Touch the desired paper type.

5

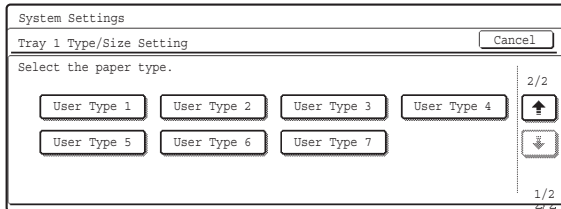
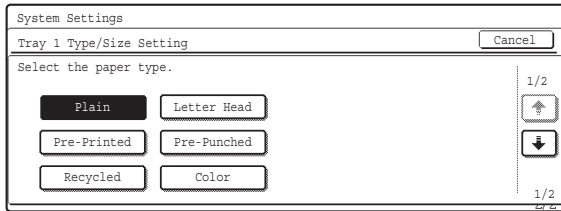

- The paper types that can be selected vary by paper tray. For more information, see "[Tray settings](#)" (page 27).
- To configure [User Type 1] to [User Type 7], see "[Paper Type Registration](#)" (page 28).

6

Select the paper size.

(1) Touch the desired paper size.

(2) Touch the [OK] key.

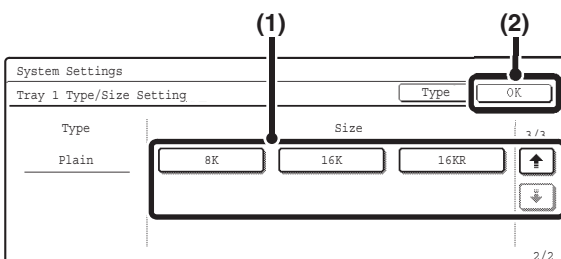
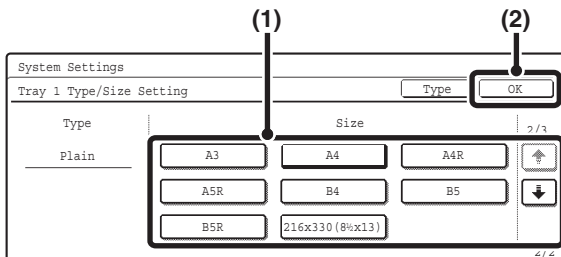
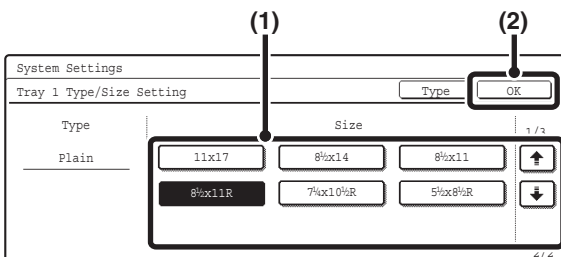

- The paper sizes that can be selected vary by paper tray. For more information, see "[Tray settings](#)" (page 27).
- When the bypass tray is selected, the paper sizes that can be selected vary depending on the paper type selected in Step 5. For more information, see "[Tray settings](#)" (page 27).
- If you wish to manually specify a special paper size that is not in the list, see "[Direct entry of the paper size](#)" (page 26).

7

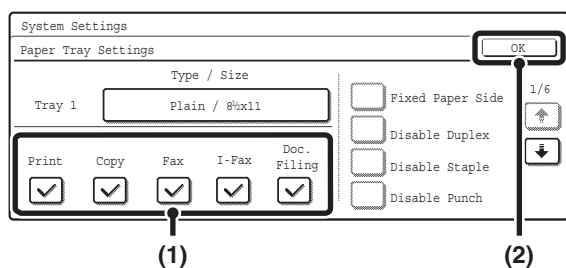

## Select print functions for the tray.

- (1) Touch the checkboxes as desired so that they show  or .
- (2) Touch the [OK] key.



- Normally all checkboxes are selected . If there is a function that you do not wish to use for the tray, remove the checkmark .
- If the paper type setting is other than plain paper, recycled paper, colored paper, or user type, the [Fax] and [I-Fax] checkboxes cannot be selected.
- The [Fax] checkbox can only be selected when the facsimile expansion kit is installed.
- Tray properties such as "Fixed Paper Side" are automatically set when the paper type is selected. The paper tray properties cannot be changed in this screen.

## Direct entry of the paper size

When the bypass tray is selected and a paper type other than transparency film or envelope is selected in step 4 of "Tray Settings" (page 24), you can follow the steps below to enter the paper size.

1

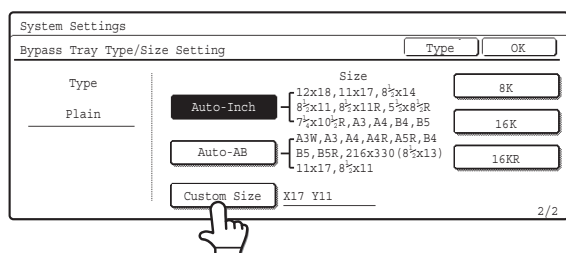

## Touch the [Custom Size] key.

2

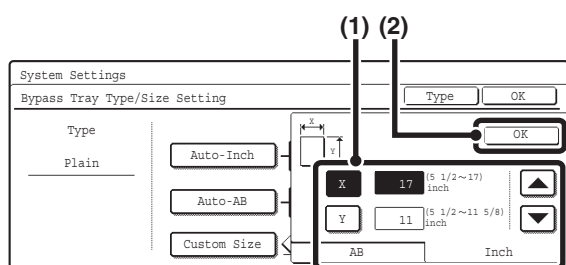

## Enter the size.

- (1) Enter the size.
  - Touch the [X] key and enter the horizontal dimension (X) of the paper with the   keys.
  - Touch the [Y] key and enter the vertical dimension (Y) of the paper with the   keys.
- (2) Touch the [OK] key.

3

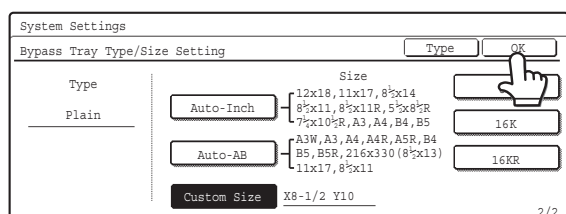

## Touch the [OK] key.



If "Disabling of Tray Setting" (page 94) has been enabled in the system settings (administrator), the tray settings cannot be configured.

## Tray settings

Paper Tray		Paper Type	Size
Tray 1, 2		<ul style="list-style-type: none"> <li>• Plain</li> <li>• Letter Head</li> <li>• Pre-Printed</li> <li>• Pre-Punched</li> <li>• Recycled</li> <li>• Color</li> <li>• User Type</li> </ul>	216 mm x 330 mm (8-1/2" x 13"), 11" x 17", 8-1/2" x 14", 8-1/2" x 11", 8-1/2" x 11"R, 7-1/4" x 10-1/2"R, 5-1/2" x 8-1/2"R, A3, A4, A4R, A5R, B4, B5, B5R 8K, 16K, 16KR
Tray 3, 4 (varies depending on the peripheral devices installed)	Stand/1x500 sheet paper drawer, Stand/2x500 sheet paper drawer installed		<ul style="list-style-type: none"> <li>• Auto-Inch 11" x 17", 8-1/2" x 14", 8-1/2" x 11", 8-1/2" x 11"R, 7-1/4" x 10-1/2"R</li> <li>• Auto-AB A3, A4, A4R, B4, B5, B5R 216 mm x 330 mm (8-1/2" x 13")</li> <li>• 8K, 16K, 16KR</li> </ul>
Tray 4, 5 (varies depending on the peripheral devices installed)	Large capacity tray installed	<ul style="list-style-type: none"> <li>• Plain</li> <li>• Letter Head</li> <li>• Pre-Printed</li> <li>• Pre-Punched</li> <li>• Recycled</li> <li>• Color</li> <li>• User Type</li> </ul>	8-1/2" x 11", A4 (paper size change must be performed by a service technician)
Bypass tray		<ul style="list-style-type: none"> <li>• Plain</li> <li>• Letter Head</li> <li>• Pre-Printed</li> <li>• Pre-Punched</li> <li>• Recycled</li> <li>• Color</li> <li>• Thin Paper</li> <li>• Heavy Paper</li> <li>• User Type</li> </ul>	<ul style="list-style-type: none"> <li>• Auto-Inch 12" x 18", 11" x 17", 8-1/2" x 14", 8-1/2" x 11", 8-1/2" x 11"R, 7-1/4" x 10-1/2"R, 5-1/2" x 8-1/2"R, A3, A4, B4, B5</li> <li>• Auto-AB A3W, A3, A4, A4R, A5R, B4, B5, B5R, 11" x 17", 216 mm x 330 mm (8-1/2" x 13"), 8-1/2" x 11"</li> <li>• 8K, 16K, 16KR</li> <li>• Custom Size</li> </ul>
		<ul style="list-style-type: none"> <li>• Labels</li> </ul>	<ul style="list-style-type: none"> <li>• Auto-Inch 8-1/2" x 11", 8-1/2" x 11"R</li> <li>• Auto-AB A4, A4R, B5, B5R</li> <li>• Custom Size</li> </ul>
		<ul style="list-style-type: none"> <li>• Transparency</li> </ul>	<ul style="list-style-type: none"> <li>• Auto-Inch 8-1/2" x 11", 8-1/2" x 11"R</li> <li>• Auto-AB A4, A4R</li> </ul>
		<ul style="list-style-type: none"> <li>• Tab Paper</li> </ul>	<ul style="list-style-type: none"> <li>• Auto-Inch 8-1/2" x 11"</li> <li>• Auto-AB A4</li> </ul>
		<ul style="list-style-type: none"> <li>• Envelope</li> </ul>	Com-10, Monarch, DL, C5

# Paper Type Registration

Configure a "User type" when the name of the paper type does not appear in the selections or when you wish to select the tray properties yourself. Up to 7 user types can be stored.

1



SYSTEM  
SETTINGS

**Press the [SYSTEM SETTINGS] key.**

2

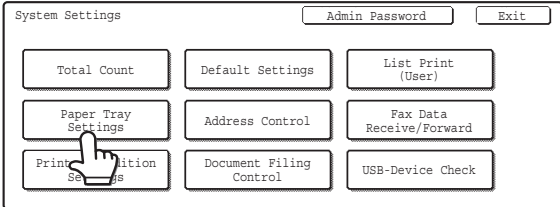

**Touch the [Paper Tray Settings] key.**

3

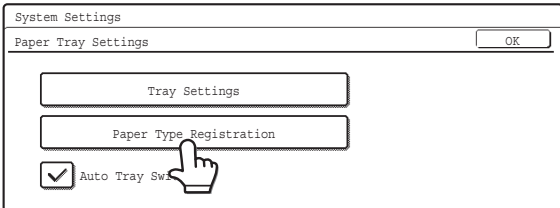

**Touch the [Paper Type Registration] key.**

4

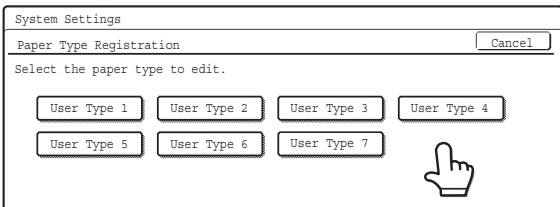

**Touch the paper type that you wish to edit.**

 The user types have been stored by factory default with the names "User Type 1" to "User Type 7".

5

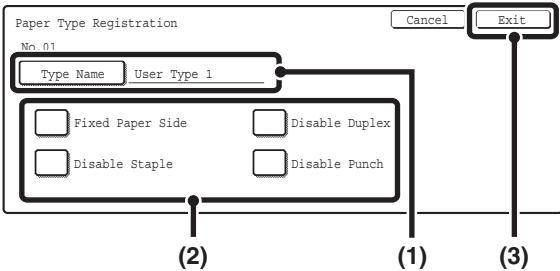

**Configure the paper type properties.**

- (1) **To change the type name, touch the [Type Name] key and change the name.**  
Clear the pre-entered name, and then enter the desired name (maximum of 14 characters).
- (2) **Touch the checkboxes as desired so that they are  or .**
- (3) **Touch the [Exit] key.**

 • To enable a property, select the checkbox .

• The settings that can be selected vary depending on the peripheral devices installed.

# Auto Tray Switching

When a tray runs out of paper during printing, this determines whether or not another tray with the same size/type of paper is automatically selected and printing continues.

1



Press the [SYSTEM SETTINGS] key.

2

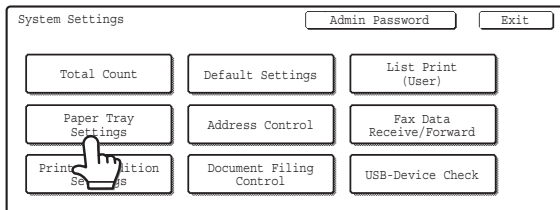

Touch the [Paper Tray Settings] key.

3

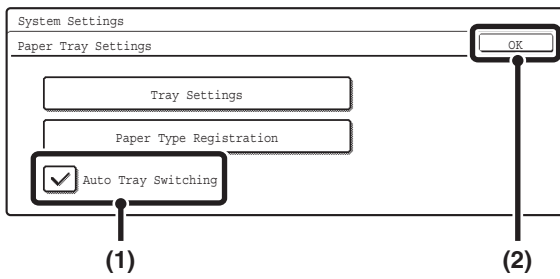

Enable or disable auto tray switching.

- (1) Touch the [Auto Tray Switching] checkbox so that  or  appears.
- (2) Touch the [OK] key.



To enable Auto Tray Switching, select the checkbox  .



---

---

# Address Control

This is used to store, edit, and delete one-touch keys, group keys, program keys, and custom indexes.

 To configure one-touch keys for fax and F-code memory boxes, see "11. SYSTEM SETTINGS FOR FAX" in the Facsimile Guide.

## Storing a One-touch Key (E-mail / Internet Fax)

An address for Scan to E-mail or Internet Fax can be stored to enable easy entry of the address.

1



Press the [SYSTEM SETTINGS] key.

2

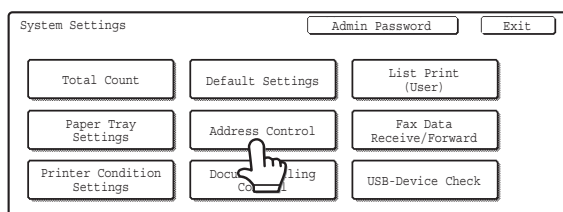

Touch the [Address Control] key.

3

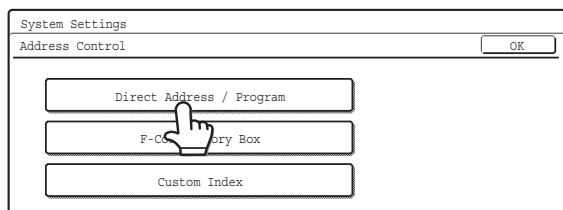

Touch the [Direct Address / Program] key.

4

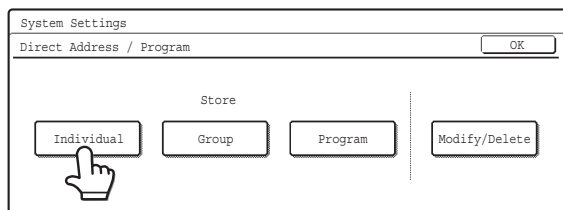

Touch the [Individual] key.

5

Touch the [E-mail] key or the [Internet Fax] key so that a checkmark appears .



- The lowest number not yet used is automatically entered as the [Search Number]. If you wish to change the search number, touch the [Search Number] key and enter a 3-digit number with the numeric keys. A search number that has already been stored cannot be used.
- Checkboxes appear when the corresponding functions are enabled.
- The checkbox selection cannot be changed later.

6

**Enter the destination name.**

- (1) Touch the [Name] key.
- (2) Enter the destination name on the text entry screen that will appear.

Enter up to 36 characters for the name.

For the procedure for entering text, see "6. ENTERING TEXT" in the User's Guide.

7

**Enter initials.**

- (1) Touch the [Initial] key.
- (2) Enter initials on the text entry screen that will appear.

Up to 10 characters can be entered.

For the procedure for entering text, see "6. ENTERING TEXT" in the User's Guide.



The initials you enter here determine the position of the one-touch key in the ABC index.

8

**Touch the [Index] key.**

## Select the index.

- (1) Touch the key of the desired index.
- (2) Touch the [OK] key.



- One of the upper row of keys, [User 1] to [User 6] (the names can be changed) can be selected to have the address appear in that index when the custom index display is selected instead of the ABC index display.
- The lower keys are for selecting whether or not to include the address in the [Frequent Use] index. It is convenient to include frequently used addresses and groups in the [Frequent Use] index.

## Enter the destination address.

- (1) Touch the [Address] key.
- (2) Enter the destination address on the text entry screen that will appear.

Up to 64 characters can be entered.

For the procedure for entering text, see "6. ENTERING TEXT" in the User's Guide.



- When the address is entered, "Registration is completed." will appear.
- Only the first 32 characters of the stored address will appear next to the [Address] key, regardless of how many characters were stored.

## E-mail

## Internet Fax

## Check the settings.

- (1) Touch the keys to switch through the screens.

- (2) Check the key name.

If you need to change the name that appears in the key, touch the [Key Name] key and enter the correct name (maximum of 18 characters).

- (3) Check the format and compression mode.

To change the settings, touch the [File Format] key or the [Compression] key. (Go to step 12)

- (A) If the address is an Internet fax address, check the I-Fax Reception Report Request setting.

Select whether or not you wish to receive a reception report by e-mail after transmission is completed. To change the setting, touch the [I-Fax Report] key and select the desired setting.



- The characters appearing next to the [Key Name] key will be displayed in the one-touch key. The first 18 characters of the address name entered in step 6 initially appear.

## E-mail

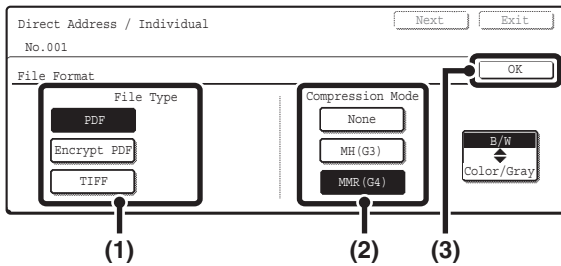

## ● To set the format

## Scanning in Mono 2

- (1) Touch the desired file type key.
- (2) Touch the desired compression mode key.
- (3) Touch the [OK] key.

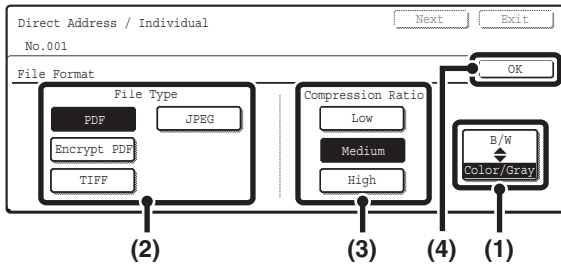

## Scanning in color/grayscale

- (1) Change the mode to Color/Grayscale mode.  
Color/Grayscale mode is selected when the [Color/Gray] key is highlighted.
- (2) Touch the desired file type key.
- (3) Touch the desired compression ratio key.
- (4) Touch the [OK] key.

## Internet Fax

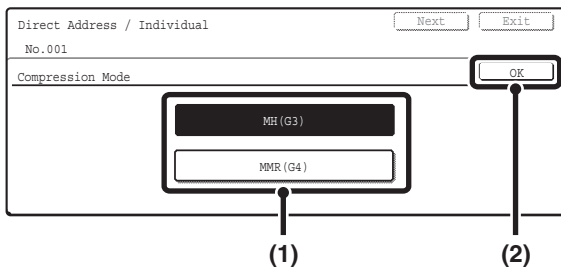

## ● To set the compression mode

- (1) Touch the desired compression mode key.
- (2) Touch the [OK] key.

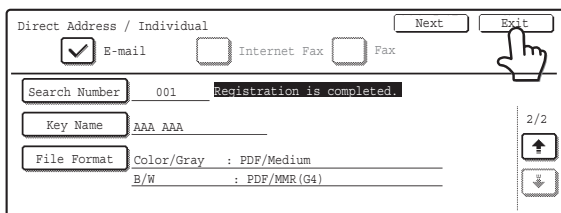

## Touch the [Exit] key.



## To store another one-touch key...

Touch the [Next] key and repeat the procedure from step 5.



- A total of 999 one-touch keys and group keys can be stored.
- It will not be possible to store destinations for a function if this has been prohibited using "Disable Registering Destination from Operation Panel" (page 106) in the system settings (administrator).

# Storing a Group Key

Multiple addresses can be stored as a group for a broadcast transmission.

1



Press the [SYSTEM SETTINGS] key.

2

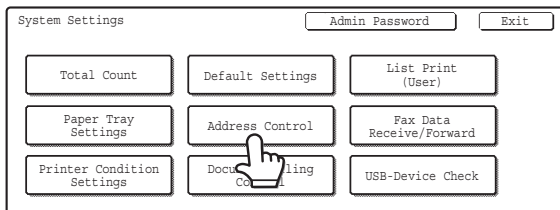

Touch the [Address Control] key.

3

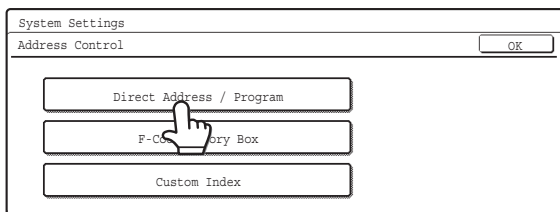

Touch the [Direct Address / Program] key.

4

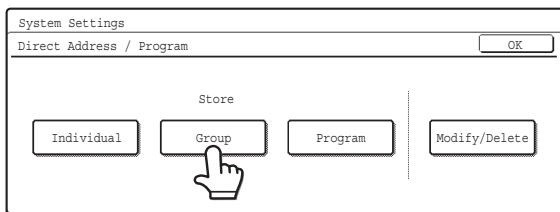

Touch the [Group] key.

5

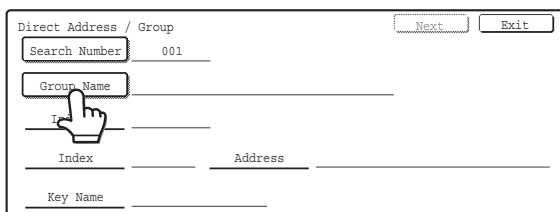

Enter a name for the group.

- (1) Touch the [Group Name] key.
- (2) Enter a name for the group on the text entry screen that will appear.

Enter up to 36 characters for the name.

For the procedure for entering text, see "6. ENTERING TEXT" in the User's Guide.



The lowest number not yet used is automatically entered as the [Search Number]. If you wish to change the search number, touch the [Search Number] key and enter a 3-digit number with the numeric keys. A search number that has already been stored cannot be used.

6

Direct Address / Group Next Exit

Search Number 001

Group Name BBB BBB

Initial

Address

Key Name

### Enter initials.

- (1) Touch the [Initial] key.
- (2) Enter initials on the text entry screen that will appear.

Up to 10 characters can be entered.

For the procedure for entering text, see "6. ENTERING TEXT" in the User's Guide.



The initials you enter here determine the position of the one-touch key in the ABC index.

7

Direct Address / Group Next Exit

Search Number 001

Group Name BBB BBB

Initial B

Index

Address

Key Name

### Touch the [Index] key.

8

Direct Address / Group Next Exit

No.001

Index

Select the custom index where you register this address.

User 1 User 2 User 3 User 4 User 5 User 6

Do you register this address at the [Frequent Use], too?

Yes No

### Select the index.

- (1) Touch the key of the desired index.
- (2) Touch the [OK] key.



- One of the upper row of keys, [User 1] to [User 6] (the names can be changed) can be selected to have the group appear in that index when the custom index display is selected instead of the ABC index display.
- The lower keys are for selecting whether or not to include the group in the [Frequent Use] index. It is convenient to include frequently used addresses and groups in the [Frequent Use] index.

9

Direct Address / Group Next Exit

Search Number 001

Group Name BBB BBB

Initial B

Index User 1

Address

Key Name

### Touch the [Address] key.

10

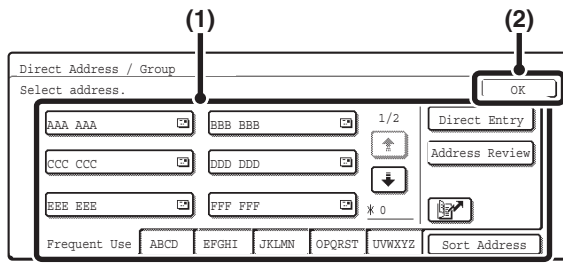

## Select the destination addresses.

### (1) Touch the keys of the desired destinations.

The selected destinations are highlighted and stored in the group key.

### (2) Touch the [OK] key.



- Touch the [OK] key. "Registration is completed." will appear.
- Keys that cannot be stored as group keys are grayed out to prevent selection.
- To directly enter an address or check the selected addresses, see "[Direct entry](#)" (page 37) and "[Checking addresses](#)" (page 37).
- Up to 500 addresses can be programmed.



### If an incorrect address is selected...

Touch the address once again so that it is not highlighted. This removes it from the group being stored.

11

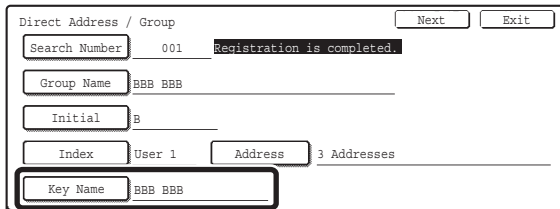

## Check the key name.

If you need to change the name that appears in the key, touch the [Key Name] key and enter the correct name (maximum of 18 characters).



The characters appearing next to the [Key Name] key will be displayed in the group key. Initially the first 18 characters of the group name entered in step 5 appear.

12

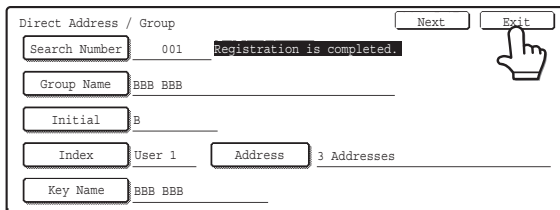

## Touch the [Exit] key.



### To store another group...

Touch the [Next] key and repeat the procedure from step 5.



- A total of 999 one-touch keys and group keys can be stored.
- It will not be possible to store a group if this has been prohibited using "[Disable Registering Destination from Operation Panel](#)" (page 106) in the system settings (administrator).

## Direct entry

Direct Address / Group  
Select address. OK

AAA AAA [E-mail] Direct Entry  
BBB BBB [Internet Fax] Address Review  
CCC CCC [Fax]

Frequent Use ABCD EFGHI JKLMN OPQRST UVWXYZ Sort Address

- To enter an address that is not stored in a one-touch key, touch the [Direct Entry] key, select the mode, and enter the address.

## Checking addresses

Direct Address / Group  
Select address to delete. OK

Group Name : BBB BBB

001 AAA AAA 002 BBB BBB 1/1  
003 CCC CCC

- To check the addresses that have been selected, touch the [Address Review] key in the address selection screen. The selected addresses are displayed.
- To deselect an address from the group, touch the displayed address.  
A message will appear to confirm the deletion. Touch the [Yes] key.

 If "Disable Direct Entry" (page 106) has been enabled in the system settings (administrator), it will not be possible to directly enter an address.



# Storing a Program

If you frequently use the same settings and/or functions to transmit to the same destination or destinations, the settings and destinations can be stored in a program. This allows the settings and destinations to be selected by simply selecting the program.

1



Press the [SYSTEM SETTINGS] key.

2

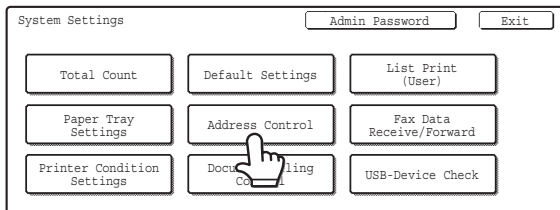

Touch the [Address Control] key.

3

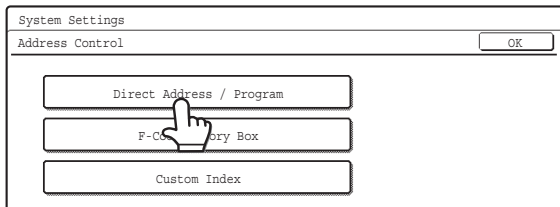

Touch the [Direct Address / Program] key.

4

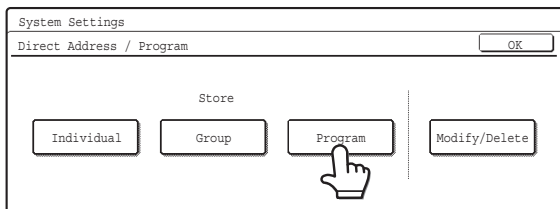

Touch the [Program] key.

5

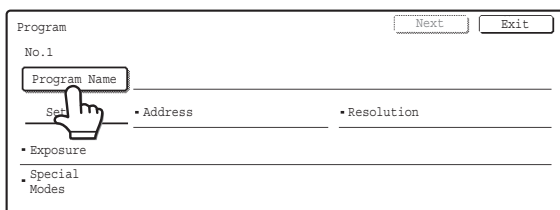

Enter a program name.

(1) Touch the [Program Name] key.

(2) Enter a program name on the text entry screen that will appear.

Enter up to 18 characters for the name.

For the procedure for entering text, see "6. ENTERING TEXT" in the User's Guide.



The program number that automatically appears is the lowest number from 1 to 48 that has not yet been programmed. (This number cannot be selected from the numbers that have not been programmed.)

6

Program Next Exit

No.1

Program Name CCC CCC

Settings • Address • Resolution

• Exposure  
• Special Modes

Touch the [Settings] key.

7

Enter program you require. Cancel OK

Mode Switch Scan Fax

Image Settings Internet Fax

Address Book  
Address Review  
Special Modes

(1)

Select settings for the program.

(1) Touch the [Mode Switch] key to select the mode that you wish to store in the program.

(2) Select the destinations and settings that you wish to include in the program.

For information on the settings, see the Scanner Guide.

(3) Touch the [OK] key.

Enter program you require. Cancel OK

Scan Mode Switch Image Settings

Address Book  
Address Review  
Special Modes

(2)

8

Program Next Exit

No.1 Registration is completed.

Program Name CCC CCC

Settings • Address :4 Addresses • Resolution :200X200dpi

• Exposure :1 • 5 Text/Photo

• Special Modes :Erase

Touch the [Exit] key.



**To store another program...**

Touch the [Next] key and repeat the procedure from step 5.



- A timer setting cannot be included in a program.
- At least one one-touch key must be specified in a program or the program cannot be stored.
- Up to 48 programs can be stored.

# Modify/Delete

Follow the steps below to edit or delete a one-touch key, group, or program.

**1**



**Press the [SYSTEM SETTINGS] key.**

**2**

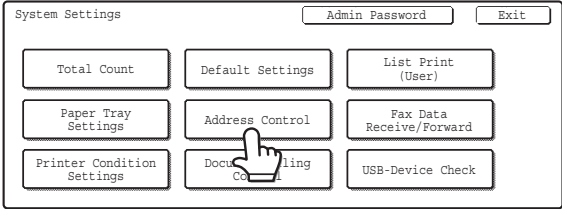

**Touch the [Address Control] key.**

**3**

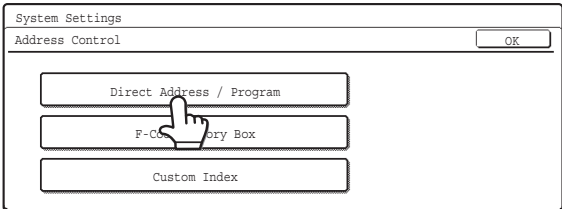

**Touch the [Direct Address / Program] key.**

**4**

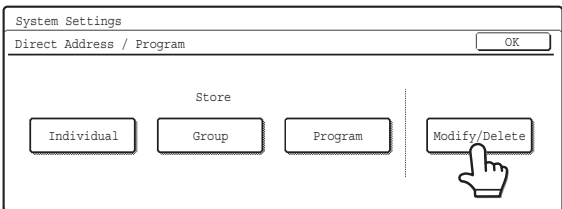

**Touch the [Modify/Delete] key.**

 If no keys have been stored, the [Modify/Delete] key cannot be selected.

**5**

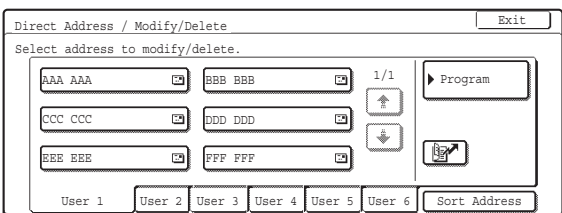

**Touch the key that you wish to edit or delete.**

## Edit/Delete

### Individual

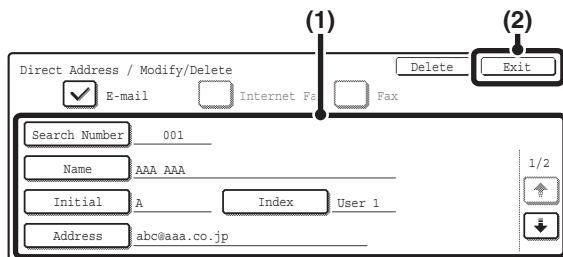

### Group

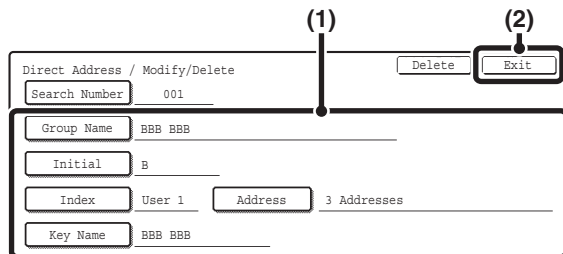

### Program

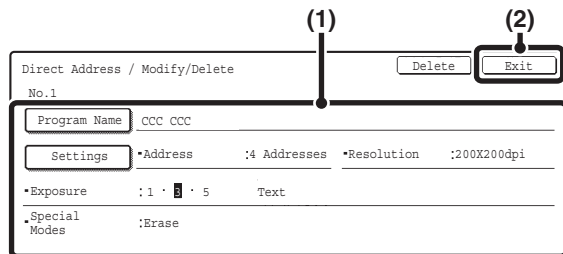

### ● Editing

- (1) Touch the keys of the items that you wish to edit.

Edit the items in the same way as you stored them.  
For the procedure for entering text, see "6. ENTERING TEXT" in the User's Guide.

- (2) Touch the [Exit] key.

### ● Deleting

- (1) Touch the [Delete] key.
- (2) Touch the [Yes] key.

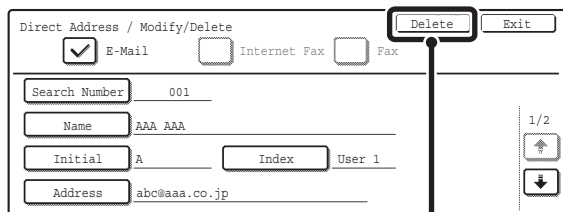

(2)

6



To cancel the deletion...

Touch the [No] key.



**If you cannot edit or delete an individual (one-touch) key or group key...**

- If the individual key or group key that you are attempting to edit or delete is being used in a reserved transmission (including a timer transmission) or a transmission in progress, wait until the transmission is finished or cancel the transmission.
- If the individual or group key that you are attempting to edit or delete is included in a group key (in the case of an individual key) or a program, delete the key from the group or program and then edit or delete the key.
- If your administrator has enabled "Default Address Setting" (on the machine) or "Inbound Routing Settings" (in the Web pages), editing and deleting will not be possible. Remove the destinations that are preventing editing/deleting, and then edit or delete the key.

# Changing the Name of a Custom Index

You can change the name of a custom index used for individual and group keys.

1



Press the [SYSTEM SETTINGS] key.

2

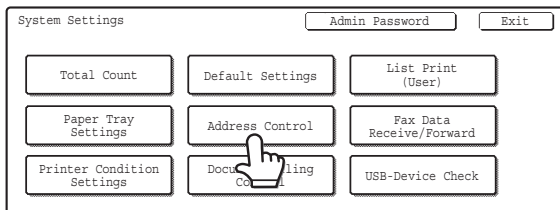

Touch the [Address Control] key.

3

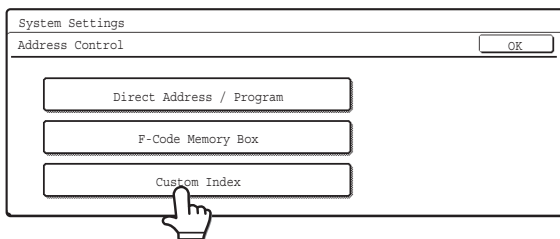

Touch the [Custom Index] key.

4

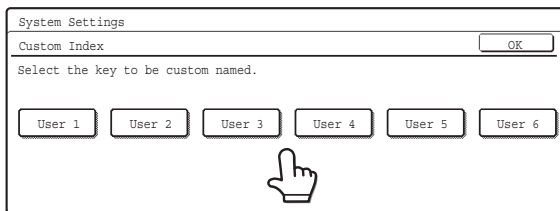

Change the index name.

(1) Touch the key of the desired index.

(2) Change the index name on the text entry screen that will appear.

Clear the pre-entered name, and then enter the desired name (maximum of 6 characters).

For the procedure for entering text, see "6. ENTERING TEXT" in the User's Guide.



- The factory default names for the custom indexes are "User 1" to "User 6".
- To change another custom index, repeat this procedure.

# Fax Data Receive/Forward

## Internet Fax Manual Reception

Follow the steps below to connect to your mail server (POP3 server) and check for received Internet faxes. If you have received Internet faxes, the faxes will be retrieved and printed.

 To use this setting, POP3 server settings must be configured. Configure these settings in the screen that appears when [Application Settings] > [Internet Fax Settings] is selected in the Web page menu. (When the Internet fax expansion kit is installed.)

1



Press the [SYSTEM SETTINGS] key.

2

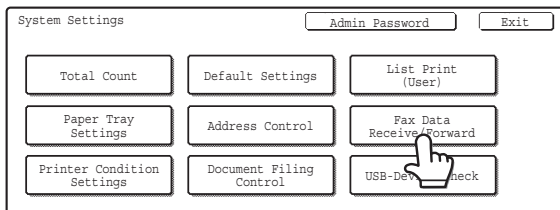

Touch the [Fax Data Receive/Forward] key.

3

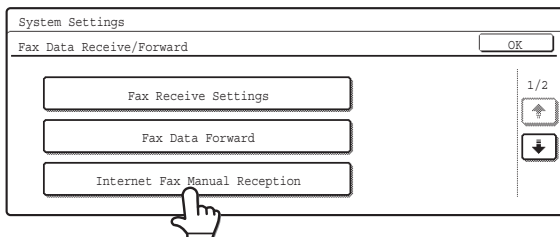

Touch the [Internet Fax Manual Reception] key.

4

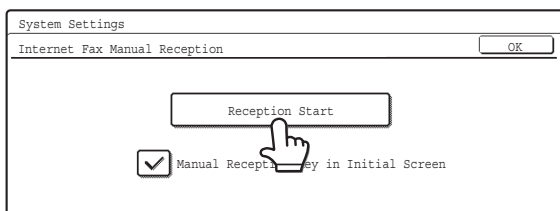

Touch the [Reception Start] key.

If you have faxes, the faxes are retrieved.

 When the [Manual Reception Key in Initial Screen] checkbox is selected , the [Manual RX] key appears in the base screen of Internet fax mode.

# Internet Fax Data Forward



When the machine cannot print because it is out of paper or out of toner, received faxes can be forwarded to another Internet fax machine.

 This procedure can be performed when the Internet fax expansion kit is installed.

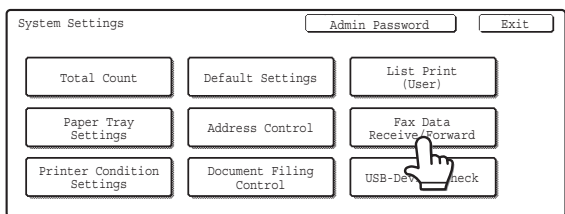
**1**  Press the [SYSTEM SETTINGS] key.

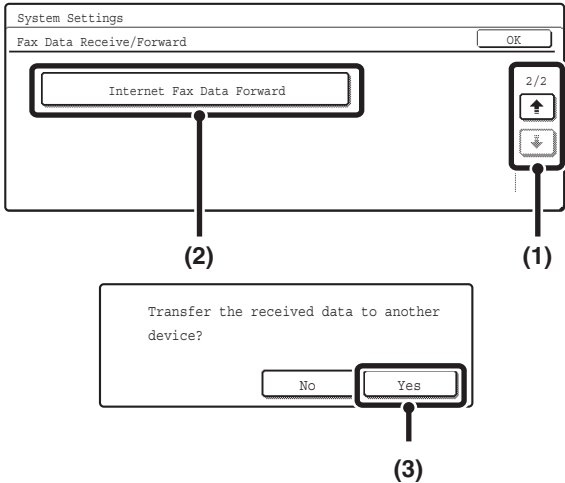
**2**  Touch the [Fax Data Receive/Forward] key.

**3**  Forward the received faxes.

- (1) Touch the   keys to switch through the screens.
- (2) Touch the [Internet Fax Data Forward] key.
- (3) Touch the [Yes] key.

-  Forwarding is not possible if no faxes were received or a forwarding machine is not programmed.
- If "[Hold Setting for Received Data Print](#)" (page 105) is enabled, you will be prompted to enter a password. Enter the correct password with the numeric keys.

 **To cancel...**  
Touch the [No] key.

 **To cancel the forwarding...**  
Press the [JOB STATUS] key, and then cancel the forwarding job in the same way as a transmission job is canceled.

-  If forwarding was not successful because the transmission was canceled or a communication error occurred, the faxes that were to be forwarded will return to the print job queue and wait to be printed on the machine.
- If the initial pages of a fax were successfully printed, only those pages that were not printed will be forwarded.
- To program the address for data forwarding, see "[Set Address for Data Forwarding](#)" (page 112) in the system settings (administrator).



---

---

# Printer Condition Settings

The printer condition settings are used to configure basic printer settings.

## Printer Default Settings

The default settings are used to set advanced print conditions for printing in an environment where the print driver is not used (such as printing from MS-DOS or from a computer that does not have the provided print driver installed).



When printing using the printer driver, the printer driver settings take precedence over the printer condition settings.

1



Press the [SYSTEM SETTINGS] key.

2

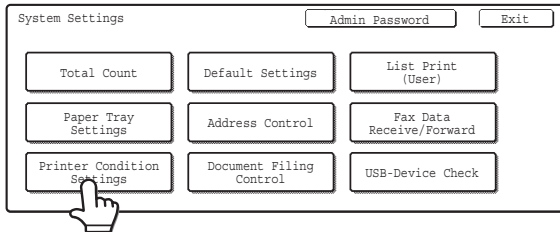

Touch the [Printer Condition Settings] key.

3

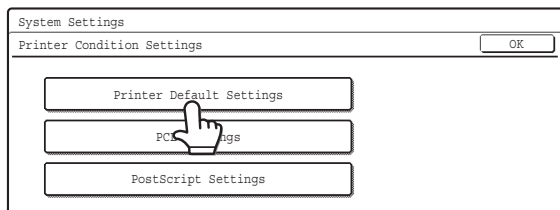

Touch the [Printer Default Settings] key.

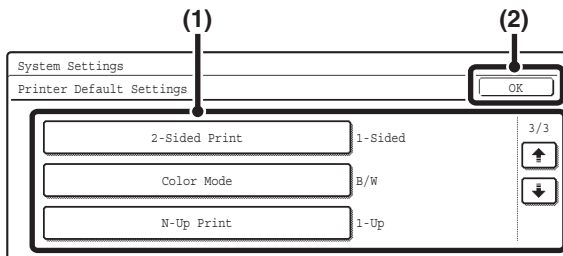
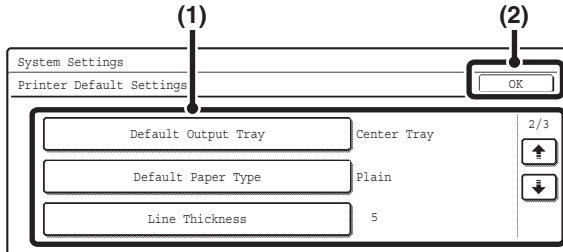
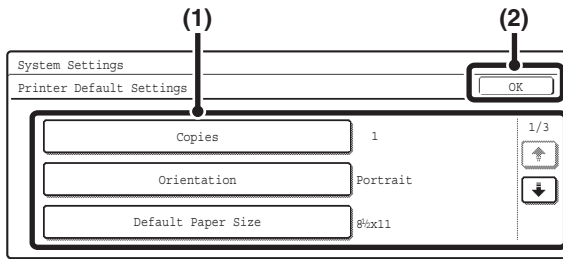

## Configure the default printer settings.

### (1) Touch the keys that you wish to configure.

When a key is touched, a setting screen appears.  
Configure the settings.

### (2) Touch the [OK] key.



For the settings, see "[Settings](#)" (page 48).

# Settings

Item	Settings	Factory default setting
<b>Copies</b>	1 - 999 sets	1
<b>Orientation</b>	<ul style="list-style-type: none"> <li>• Portrait</li> <li>• Landscape</li> </ul>	Portrait
<b>Default Paper Size</b>	11" x 17", 8-1/2" x 14", 8-1/2" x 13", 8-1/2" x 11", 7-1/4" x 10-1/2", 5-1/2" x 8-1/2", A3, B4, A4, B5, A5, 8k, 16k	8-1/2" x 11"
<b>Default Output Tray*1</b>	<ul style="list-style-type: none"> <li>• Center Tray</li> <li>• Finisher Tray*2</li> <li>• Right Tray</li> </ul>	Center Tray (Finisher Tray*2)
<b>Default Paper Type</b>	Plain Paper, Letter Head, Pre-Printed, Pre-Punched, Recycle Paper, Color	Plain Paper
<b>Line Thickness*3</b>	0 - 9	5
<b>2-Sided Print</b>	<ul style="list-style-type: none"> <li>• 1-Sided</li> <li>• 2-Sided (Book)</li> <li>• 2-Sided (Tablet)</li> </ul>	1-Sided
<b>Color Mode</b>	<ul style="list-style-type: none"> <li>• Color</li> <li>• B/W</li> </ul>	B/W
<b>N-Up Print</b>	<ul style="list-style-type: none"> <li>• 1-Up</li> <li>• 2-Up</li> <li>• 4-Up</li> </ul>	1-Up

\*1 When a right tray is installed.

\*2 When a saddle stitch finisher or finisher is installed.

\*3 This setting is used to adjust the line width of vector graphics (black and white printing only). Except for CAD and other specialized uses, there is normally no need to change this setting. For more information on the values that can be set, see the table below.

## Values for the line thickness setting

Settings	0	1	2	3	4	5	6	7	8	9
<b>Percentage</b>	minimum line width*	50%	75%	90%	95%	100%	105%	110%	125%	150%

\* All lines are minimum line width.

# PCL Settings

This is used to set the symbol sets, fonts, and line feed code used in PCL6 and PCL5c environment.

1



Press the [SYSTEM SETTINGS] key.

2

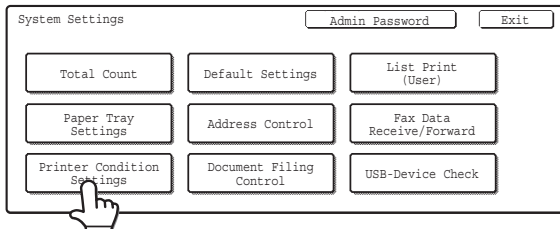

Touch the [Printer Condition Settings] key.

3

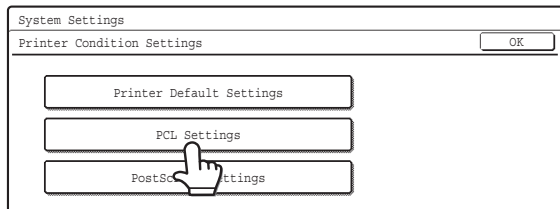

Touch the [PCL Settings] key.

4

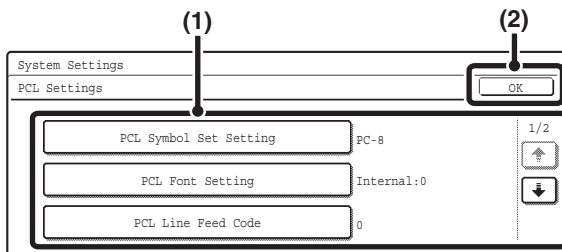

Configure the PCL settings.

(1) Touch the keys or checkboxes of the items that you wish to configure.

When a key is touched, a setting screen appears. Configure the settings.

For a checkbox setting, touch the checkbox to set it to  or  as desired.

(2) Touch the [OK] key.

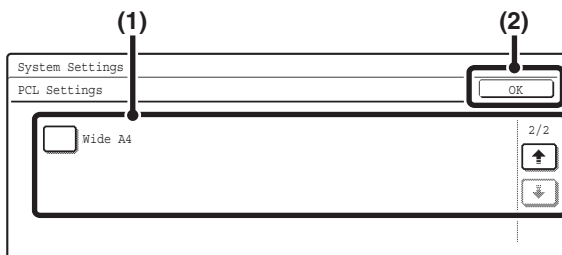

For the settings, see "Settings" (page 50).

# Settings

Item	Settings	Factory default setting
<b>PCL Symbol Set Setting</b> Specify the symbol set used for printing.	Select from 35 items.	3. (PC-8)
<b>PCL Font Setting</b> Use this to select the font used for printing.	<ul style="list-style-type: none"> <li>• Internal Font</li> <li>• Extended Font</li> </ul> (List of internal fonts when extended fonts are not installed.)	Internal Font 0. (Courier)
<b>PCL Line Feed Code</b> This setting is used to select how the printer responds when a line feed command is received.	<ul style="list-style-type: none"> <li>• 0.CR=CR; LF=LF; FF=FF</li> <li>• 1.CR=CR+LF; LF=LF;FF=FF</li> <li>• 2.CR=CR; LF=CR+LF; FF=CR+FF</li> <li>• 3.CR=CR+LF; LF=CR+LF; FF=CR+FF</li> </ul>	0. CR=CR; LF=LF; FF=FF
<b>Wide A4</b> When this is enabled, 80 characters per line can be printed on A4 size paper using a 10-pitch font. (When this setting is disabled, up to 78 characters can be printed.)	<ul style="list-style-type: none"> <li>• <input checked="" type="checkbox"/> (Enabled)</li> <li>• <input type="checkbox"/> (Disabled)</li> </ul>	<input type="checkbox"/> (Disabled)

# Postscript Settings

When a PS (PostScript) error occurs during PostScript printing, this setting determines whether or not an error notice is printed.



This procedure can be performed when the PS3 expansion kit is installed.

1



Press the [SYSTEM SETTINGS] key.

2

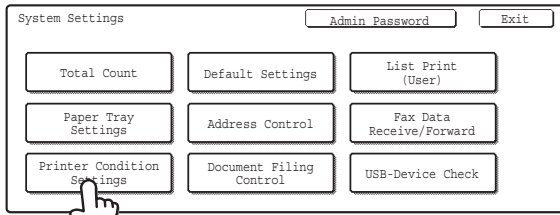

Touch the [Printer Condition Settings] key.

3

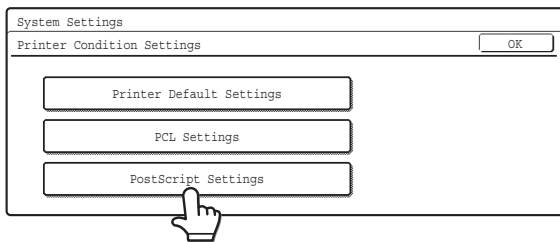

Touch the [PostScript Settings] key.

4



Configure the PS settings.

(1) Touch the [Print PS Errors] checkbox so that  or  appears.

(2) Touch the [OK] key.



To have PS error notices printed, select the checkbox .

---

---

# Document Filing Control

This is used to create, edit, and delete custom folders for document filing.

## Custom Folder Registration

Follow these steps to create a custom folder.

1



Press the [SYSTEM SETTINGS] key.

2

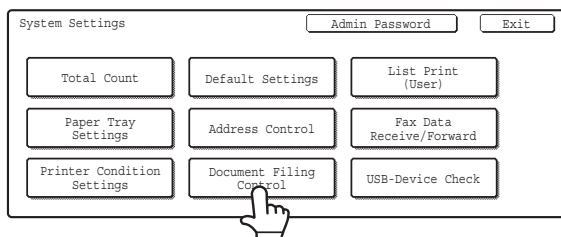

Touch the [Document Filing Control] key.

3

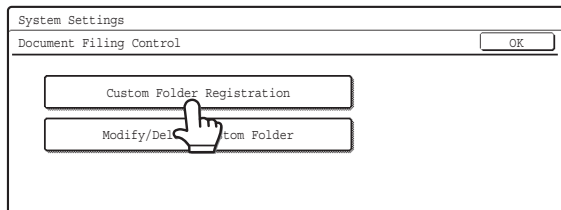

Touch the [Custom Folder Registration] key.

4

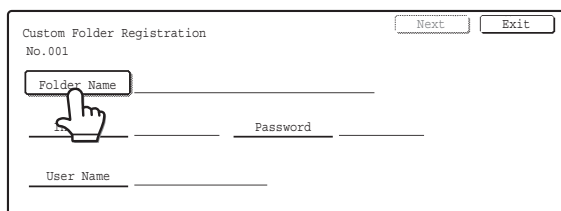

Enter a folder name.

- (1) Touch the [Folder Name] key.
- (2) Enter a folder name on the text entry screen that will appear.

Enter up to 28 characters.

For the procedure for entering text, see "6. ENTERING TEXT" in the User's Guide.



- The "No." that automatically appears is the lowest number from 001 to 500 that has not yet been programmed. (This number cannot be selected from the numbers that have not been programmed.)
- A name cannot be programmed if it is already being used for another folder.

5

Custom Folder Registration  
No.001

Folder Name User 1

Initial \_\_\_\_\_ Password \_\_\_\_\_

User Name \_\_\_\_\_

Next Exit

### Enter initials.

- (1) Touch the [Initial] key.
- (2) Enter initials on the text entry screen that will appear.

Up to 10 characters can be entered.

For the procedure for entering text, see "6. ENTERING TEXT" in the User's Guide.

6

Custom Folder Registration  
No.001

Folder Name User 1

Initial U Password \_\_\_\_\_

User Name \_\_\_\_\_

Next Exit

### Touch the [User Name] key.

7

Custom Folder Registration  
Select user name.

AAA AAA BBB BBB 1 Default User

CCC CCC DDD DDD 25

EEE EEE FFF FFF

GGG GGG HHH HHH

All Users ABCD EFGHI JKLMN OPQRST UVWXYZ ABC User

Cancel

### Select the user.



If no users have been stored, touch the [Default User] key to select a factory default user.

8

Custom Folder Registration  
No.001 Registration is completed.

Folder Name User 1

Initial U Password \_\_\_\_\_

User Name BBB BBB

Next Exit

### To set a password, touch the [Password] key.



A password can be omitted.

9

Custom Folder Registration  
No.001

Password \_\_\_\_\_ Cancel OK

Enter password via the 10-key pad.

\* \* \* \* \*

(1) (2)

### Enter a password.

- (1) Enter a 5 to 8-digit password with the numeric keys.
- (2) Touch the [OK] key.



If you touch the [OK] key without entering anything, a password will not be created.



Custom Folder Registration

No.001 Registration is completed

Folder Name User 1

Initial U Password \*\*\*\*\*

User Name BBB BBB

Next Exit

Touch the [Exit] key.



**To create another folder...**

Touch the [Next] key and repeat the procedure from step 4.



Up to 500 custom folders can be created.

When no further folders can be created, delete unneeded folders and then create a new folder. To delete a folder, see "[Modify/Delete Custom Folder](#)" (page 55).

# Modify/Delete Custom Folder

Follow the steps below to edit or delete a custom folder.

1



Press the [SYSTEM SETTINGS] key.

2

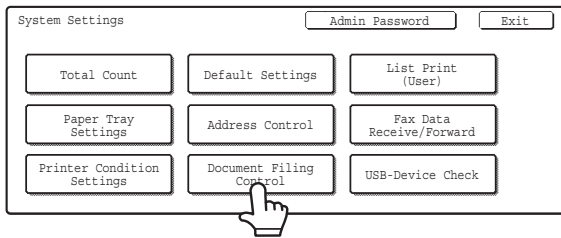

Touch the [Document Filing Control] key.

3

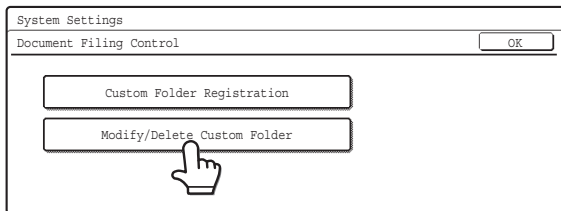

Touch the [Modify/Delete Custom Folder] key.

4

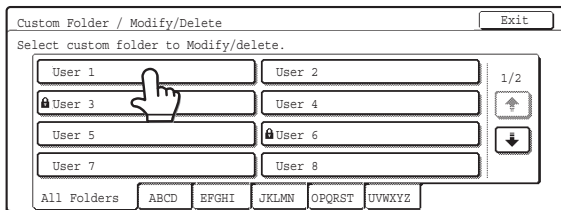

Touch the folder that you wish to edit or delete.



- If a password has been set for the folder, the following password entry screen will appear. Enter the correct password with the numeric keys and touch the [OK] key.

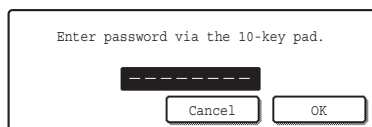

- If "Delete Folder" is enabled in "[Administrator Authority Setting](#)" (page 114) in the system settings (administrator), the following screen will appear. When the [Admin] key is touched, a folder can be deleted with the administrator password. (Cannot be edited.)

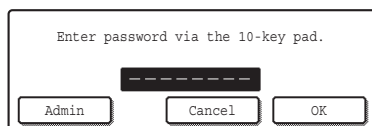

## Edit/Delete

### ● Editing

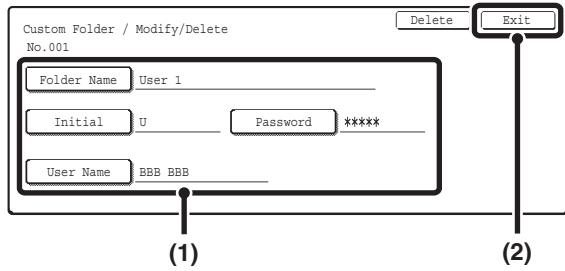

- (1) Touch the keys of the items that you wish to edit.

Edit the items in the same way as you stored them.  
For the procedure for entering text, see "6. ENTERING TEXT" in the User's Guide.

- (2) Touch the [Exit] key.

### ● Deleting

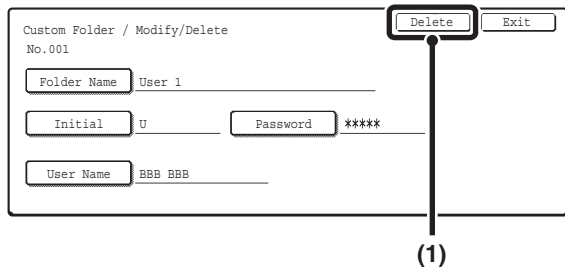

- (1) Touch the [Delete] key.

- (2) Touch the [Yes] key.

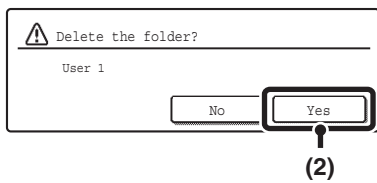

A folder that contains files cannot be deleted. Either move the files to a different folder or delete them before deleting the folder.



#### To cancel the deletion...

Touch the [No] key.

---

---

# USB-Device Check

This lets you check the connection when a USB device is connected to the machine.

1



Press the [SYSTEM SETTINGS] key.

2

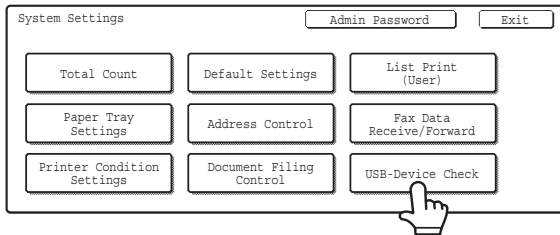

Touch the [USB-Device Check] key.

3

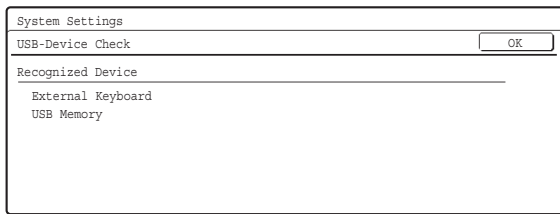

Check the status of the connection.



- The status of a USB device that is not compatible with the machine will not appear.
- Connection information on a USB hub (must be purchased separately) will not appear.



- A USB hub (must be purchased separately) has four ports. A different type of device (USB memory, USB keyboard, etc.) must be connected to each port.
- If two or more of the same type of USB devices are connected, only the device that was connected first will be recognized. In this state, even if the recognized USB device is removed, the other USB device will not be recognized. Disconnect and then reconnect the USB device that you wish to use.

# User Control



- This setting can only be configured when "User Authentication Setting" (page 80) is enabled.
- Depending on the user that logged in, use of the following settings may not be possible.

## Modify User Information

The information of the currently logged in user can be edited.

1



Press the [SYSTEM SETTINGS] key.

2

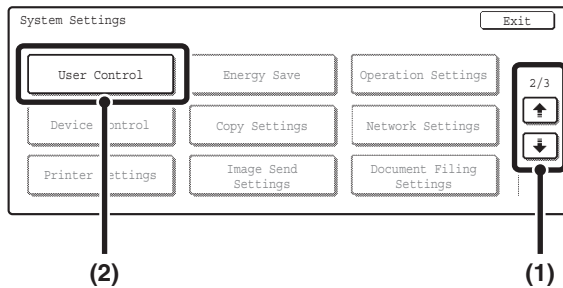

Select the [User Control].

- (1) Touch the keys to switch through the screens.
- (2) Touch the [User Control] key.

3

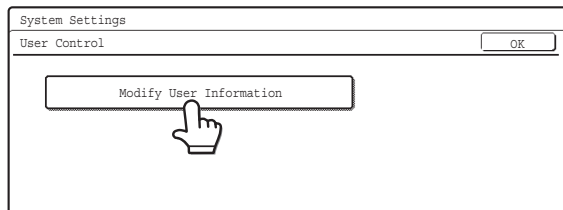

Touch the [Modify User Information] key.

## Modify user information.

- (1) Touch the desired items and edit the contents.

Edit the items in the same way as you stored them. For the procedure for entering text, see "6. ENTERING TEXT" in the User's Guide.

- (2) Touch the [Exit] key.



For detailed explanations of each of the settings, see "[Editable items](#)".

## Editable items

User Information	Settings
User Name	Edit the name of the user (max. 32 characters). This user name is used for the key name in the login screen, the document filing user name and the sender name. (The user name must be unique.)
Initial	Enter the initials (maximum of 10 characters). The initials determine where the user name will appear in the user name list.
Index	Select the desired custom index. The custom index names are shared with the custom indexes of the address book.
Login Name	This cannot be edited.
Password	Enter the password used for user authentication by user name and password (1 to 32 characters). (The password can be omitted.)
E-mail Address	This cannot be edited.
My Folder	This cannot be edited.
Auth to:	This cannot be edited.
Page Limit	This cannot be edited.
Authority	This cannot be edited.
Favorites	Select the operation settings that are applied at login from the stored Favorite Operation Groups. Check with your administrator for the settings of the Favorite Operation Groups.
(User number) * This appears only when user authentication is controlled by user number.	This cannot be edited.

# 2

## SYSTEM SETTINGS (ADMINISTRATOR)

This chapter explains the system settings that are configured by the administrator of the machine.

---

---

### Accessing the System Settings (Administrator)

To access the system settings (administrator), the administrator must follow the procedure below to log in.

#### When User Authentication is not Enabled

When "User Authentication Setting" (page 80) is not enabled, follow the procedure below to log in.

1



Press the [SYSTEM SETTINGS] key.

2

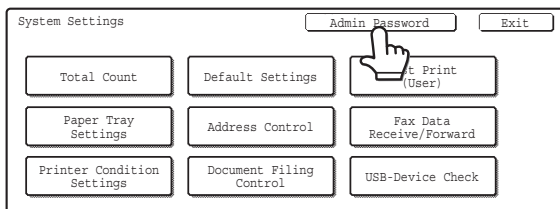

Touch the [Admin Password] key.

3

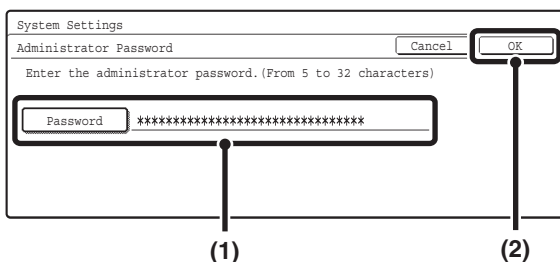

Log in.

(1) Touch the [Password] key and enter the administrator password.

For the procedure for entering text, see "6. ENTERING TEXT" in the User's Guide.

(2) Touch the [OK] key.

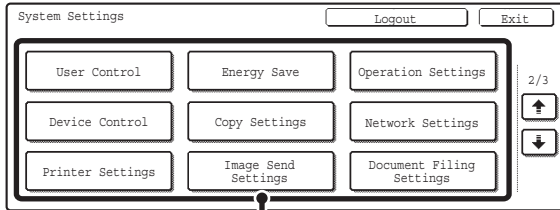
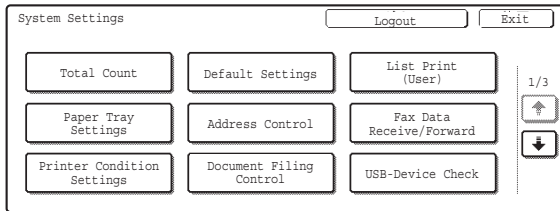

(A)

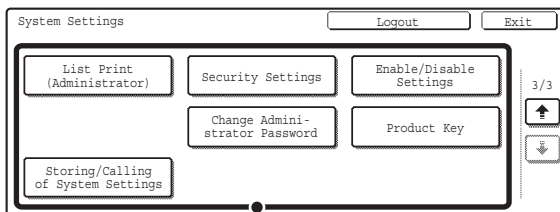

(A)

## Configure the desired system settings.

Touch the items that you wish to configure and select the desired settings.



- For detailed explanations of each of the settings, see the following pages of this chapter.
- Items marked (A) above are indicated as "System Settings (Administrator)" in this manual to distinguish them from the general user system settings.
- If Auto Clear activates, logout will automatically take place.
- **To logout...**  
Touch the [Logout] key in the top right corner of the screen or touch the [Exit] key to quit the system settings.



User authentication is initially disabled (factory default setting).



# When User Authentication is Enabled

When "User Authentication Setting" (page 80) is enabled, follow the procedure below to log in.



- For the procedure for enabling user authentication, see "User Control" (page 80).
- When auto login is enabled, the login screen will not appear.

## ● Login by login name and password (and e-mail address\*)

### (1) Touch the [Login Name] key.

\* If login name / password / e-mail address is selected for the login method, [E-mail Address] will appear under the [Login Name] key shown on the left.

### (2) Touch the [Admin Login] key.

### (3) Touch the [Password] key and enter the administrator password.

For the procedure for entering text, see "6. ENTERING TEXT" in the User's Guide.

### (4) Touch the [OK] key and go to step 3.

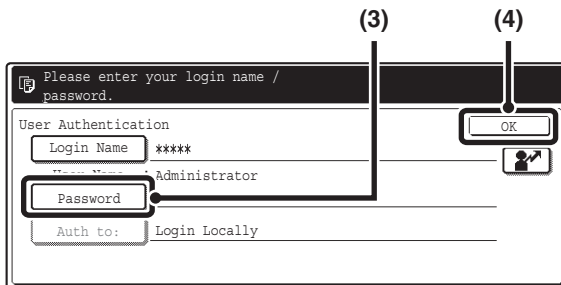
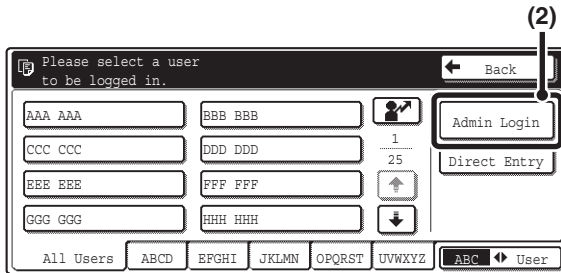
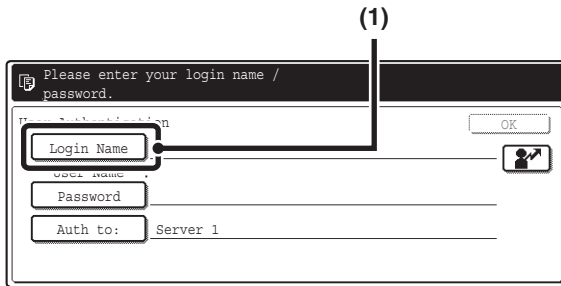

## ● Login by user number

Touch the [Admin Login] key.

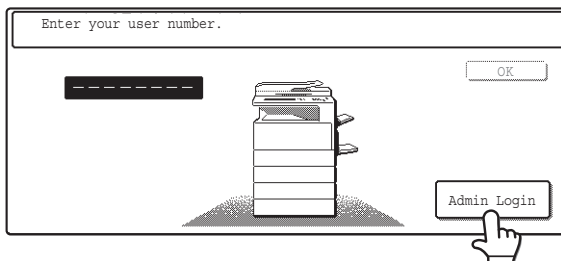

In addition to login in by touching the [Admin Login] key, the system settings (administrator) can also be accessed when login is performed by selecting a user with administrator rights from the user list or by entering a user number with administrator rights.

For these login procedures, see "When User Authentication is Enabled" (page 6).

2

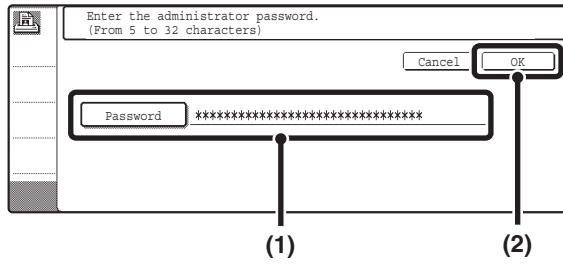

### Enter the administrator password.

(1) Touch the [Password] key and enter the administrator password.

For the procedure for entering text, see "6. ENTERING TEXT" in the User's Guide.

(2) Touch the [OK] key.

3



### Press the [SYSTEM SETTINGS] key.



This step is not necessary if you are logging in after you pressed the [SYSTEM SETTINGS] key.

4

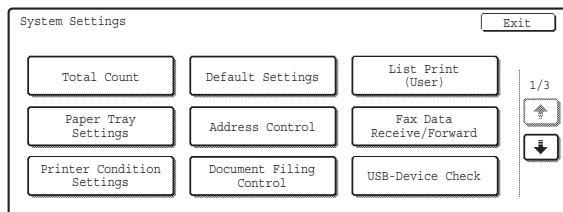

### Configure the desired system settings.

Touch the items that you wish to configure and select the desired settings.

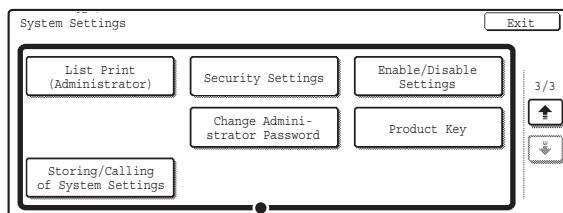
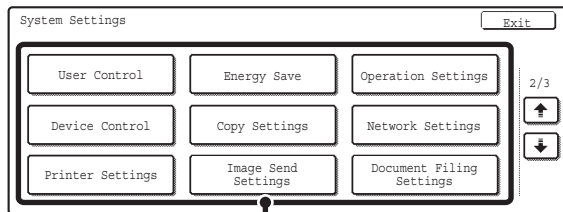

- For detailed explanations of each of the settings, see the following pages of this chapter.
- Items marked (A) above are indicated as "System Settings (Administrator)" in this manual to distinguish them from the general user system settings.
- If Auto Clear activates, logout will automatically take place.
- **To logout...**  
Press the [LOGOUT] key (⌘). (Except when entering a fax number.)

# System Settings (Administrator) List

When the system settings are accessed with administrator rights, the following items appear. The factory default setting for each item is also shown.

 Depending on the machine specifications and peripheral devices installed, it may not be possible to use some settings.

## General items

Item	Factory default setting	Page
■ Total Count	For information on the system settings accessed with general rights, see " <a href="#">System Settings (General) List</a> ".	9
■ Default Settings		
■ List Print (User)		
■ Paper Tray Settings		
■ Address Control		
■ Fax Data Receive/Forward		
■ Printer Condition Settings		
■ Document Filing Control		
■ USB-Device Check		

## Administrator items

Item	Factory default setting	Page
■ <a href="#">User Control</a>		80
● <a href="#">User Authentication Setting</a>		80
▶ <a href="#">User Authentication</a>	Disable	80
▶ <a href="#">Authentication Method Setting</a>	Authenticate a User by Login Name and Password	80
▶ <a href="#">Device Account Mode Setting</a>		80
◆ Device Account Mode	Disable	
◆ User Selection	–	
● <a href="#">User Registration</a>		81
▶ Store	–	
▶ Modify/Delete	–	
▶ Delete All Users	–	

Item	Factory default setting	Page
● Pages Limit Group Registration	–	83
● Actions when the Limit of Pages for Output Jobs	Job is Stopped when the Limit of Pages is Reached	83
● Authority Group Registration	–	84
● Favorite Operation Group Registration	–	86
● User Count Display	–	87
● User Count Reset	–	87
● User Information Print		88
▶ All User Information Print	–	
▶ User List	–	
▶ List of Number of Pages Used	–	
▶ Page Limit Group List	–	
▶ Authority Group List	–	
▶ Favorite Operation Group List	–	
● The Number of User Name Displayed Setting	8	88
● A Warning when Login Fails	Disable	88
● Disable Printing by Invalid User	Disable	88
● Default Network Authentication Server Setting	–	88
■ Energy Save		89
● Toner Save in Printer Mode	Disable	89
● Toner Save in Copy Mode	Disable	89
● Auto Power Shut-Off	Enable	89
● Auto Power Shut-Off Timer	45 min.	89
● Preheat Mode Setting	15 min.	89
■ Operation Settings		90
● Keys Touch Sound		90
▶ Keys Touch Sound	Middle	
▶ Keys Touch Sound at Initial Point	Disable	
● Auto Clear Setting	60 sec.	90
▶ Cancel Timer	Disable	
● Message Time Setting	6 sec.	90
● Display Language Setting	American English	90
● Disabling of Job Priority Operation	Disable	90
● Disabling of Bypass Printing	Disable	91
● Key Operation Setting	0.0 sec.	91
▶ Disable Auto Key Repeat	Disable	
● Disabling of Clock Adjustment	Disable	91

Item	Factory default setting	Page	
● <a href="#">Disabling of Covers/Inserts Mode</a>	Disable	91	
● <a href="#">Customize Key Setting</a>		91	
▶ Copy			
◆ Customize 1	Special Modes		
◆ Customize 2	File		
◆ Customize 3	Quick File		
▶ Scanner			
◆ Customize 1	Special Modes		
◆ Customize 2	File		
◆ Customize 3	Quick File		
▶ Internet Fax*1			
◆ Customize 1	Special Modes		
◆ Customize 2	File		
◆ Customize 3	Quick File		
▶ Fax*2			
◆ Customize 1	Special Modes		
◆ Customize 2	File		
◆ Customize 3	Quick File		
▶ USB Memory Scan			
◆ Customize 1	Special Modes		
◆ Customize 2	Erase		
◆ Customize 3	Suppress BG		
▶ Data Entry			
◆ Customize 1	Special Modes		
◆ Customize 2	File		
◆ Customize 3	Quick File		
■ <a href="#">Device Control</a>			93
● <a href="#">Original Size Detector Setting</a>			93
▶ Original Detection Size Combination	Inch-1		
▶ Cancel Detection at Document Glass	Disable		
● <a href="#">Disabling of Document Feeder</a>	Disable	93	
● <a href="#">Original Feeding Mode</a>	All Disabled	93	
● <a href="#">Disabling of Duplex</a>	Disable	93	
● <a href="#">Disabling of Large Capacity Cassette*3</a>	Disable	93	
● <a href="#">Disabling of Optional Paper Drawer*4</a>	Disable	94	
● <a href="#">Disabling of Tray Setting</a>	Disable	94	

Item	Factory default setting	Page
● Disabling of Finisher*5	Disable	94
● Disabling of Offset	Disable	94
● Disabling of Stapler*5	Disable	94
● Saddle Stitch Position Adjust*6	0.0 mm	94
● Disabling of Punch*7	Disable	94
● Disabling of Color Mode*8	Disable	94
● Auto Paper Selection Setting	Plain Paper	95
● Registration Adjustment		95
▶ Auto Adjustment	–	
● Optimization of the Hard Disk	–	95
● Tandem Connection Setting		
▶ IP Address of Slave Machine	0.0.0.0	
▶ Port Number	50001	95
▶ Disabling of Master Machine Mode	Disable	
▶ Disabling of Slave Machine Mode	Disable	
● Clear All Job Log Data	–	95
● Detect Standard in Auto Color Mode	3	95
■ Copy Settings		96
● Initial Status Settings		
▶ Color Mode	Full Color	
▶ Paper Tray	Varies depending on the machine configuration	
▶ Exposure Type	Auto	96
▶ Copy Ratio	100%	
▶ 2-Sided Copy	1-Side to 1-Side	
▶ Output	–	
● Exposure Adjustment		
▶ Color		
◆ Document Glass	5	
◆ Document Feeder	5	96
▶ B/W		
◆ Document Glass	5	
◆ Document Feeder	5	
● Rotation Copy Setting	Enable	96
● Add or Change Extra Preset Ratios		
▶ Reduction	–	96
▶ Enlargement	–	

Item	Factory default setting	Page
● Setting a Maximum Number of Copies	999	96
● Initial Margin Shift Setting		97
▶ Side-1	1/2"	
▶ Side-2		
● Erase Width Adjustment		97
▶ Edge	1/2"	
▶ Center		
● Card Shot Settings		97
▶ Original Size	X: 3-3/8" Y: 2-1/8"	
▶ Fit to Page	Disable	
● Automatic Saddle Stitch*6	Enable	97
● Initial Tab Copy Setting	1/2"	97
● Disabling Deletion of Job Programs	Disable	97
● Disabling of Bypass-Tray in Duplex Copy	Disable	97
● Disabling of Auto Paper Selection	Disable	97
● Auto Selection Setting of Tray that is Supplied the Paper	Disable	98
● Initial Color Balance Setting	Factory Default State	98
● Auto Color Calibration	–	98
● B/W 600dpi x 600dpi Scanning Mode for Document Feeder	Disable	99
● B/W Quick Scan from Document Glass	Enable	99
<b>■ Network Settings</b>		100
● IP Address Setting	DHCP	100
● Enable TCP/IP	Enable	100
● Enable NetWare	Enable	100
● Enable EtherTalk	Enable	100
● Enable NetBEUI	Enable	100
● Reset the NIC	–	100
● Ping Command	–	100
<b>■ Printer Settings</b>		101
● Default Settings		101
▶ Prohibit Notice Page Printing	Enable	101
▶ Prohibit Test Page Printing	Disable	101
▶ A4/Letter Size Auto Change	Disable	101
▶ Print Density Level		101
◆ Color	3	
◆ B/W	3	

Item	Factory default setting	Page
▶ Bypass Tray Settings		
◆ Enable Detected Paper Size in Bypass Tray	Disable	101
◆ Enable Selected Paper Type in Bypass Tray	Enable	
◆ Exclude Bypass-Tray from Auto Paper Select	Disable	
▶ Job Spool Queuing	Enable	101
● Interface Settings		102
▶ Hexadecimal Dump Mode	Disable	102
▶ I/O Timeout	20 sec.	102
▶ Enable USB Port	Enable	102
▶ USB Port Emulation Switching	PCL (Auto*9)	102
▶ Enable Network Port	Enable	102
▶ Network Port Emulation Switching	PCL (Auto*9)	102
▶ Port Switching Method	Switch at End of Job	103
● Color Adjustments		103
▶ Auto Color Calibration	–	103
■ Image Send Settings		104
● Operation Settings		104
▶ Default Display Setting		
◆ Mode	Scanner (Fax*2)	104
◆ Hold settings for a while after scanning has been completed	Disable	
◆ Switch Automatically to Copy Mode Screen	Enable	
▶ Initial Resolution Setting		
◆ Apply the Resolution Set when Stored	Disable	104
◆ Scanner	200X200dpi	
◆ Internet Fax*1	200X100dpi	
◆ Fax*2	Standard	
▶ Default Exposure Settings		
◆ Exposure	Auto	104
◆ Original Image Type	Text	
◆ Moiré Reduction	Disable	
▶ Must Input Next Address Key at Broadcast Setting	Disable	105
▶ Scan Complete Sound Setting	Middle	105
▶ The Number of File Name/Subject/Body Keys Displayed Setting	6	105
▶ The Number of Direct Address Keys Displayed Setting	6	105
▶ Disable Switching of Display Order	Disable	105



Item	Factory default setting	Page
▶ Hold Setting for Received Data Print		
◆ Received Data Hold	Disable	105
◆ Password Setting	–	
▶ Settings to Disable the Registration of Destination		106
◆ Disable Registering Destination from Operation Panel		
• Group	Disable	106
• E-mail	Disable	
• Internet Fax	Disable	
• Fax	Disable	
◆ Disable Registering Destination on Web Page*10		
• Group	Disable	106
• E-mail	Disable	
• FTP	Disable	
• Desktop	Disable	
• Network Folder	Disable	
• Internet Fax	Disable	
• Fax	Disable	
◆ Disable Registration Using Network Scan Tools*10	Disable	106
▶ Settings to Disable Transmission		106
◆ Disable [Resend] on Fax/Image Send Mode	Disable	106
◆ Disable Selection from the Address Book		
• E-mail	Disable	106
• FTP	Disable	
• Desktop	Disable	
• Network Folder	Disable	
• Internet Fax	Disable	
• Fax	Disable	
◆ Disable Direct Entry		
• E-mail	Disable	106
• Internet Fax	Disable	
• Fax	Disable	
◆ Disable PC-I-Fax Transmission*1	Disable	106
◆ Disable PC-Fax Transmission*2	Disable	106

Item	Factory default setting	Page
● Scan Settings		107
▶ Default Sender Set	–	107
▶ Default Color Mode Settings		107
◆ Color Mode	Auto, Grayscale	
◆ B/W Mode	Mono 2	
◆ Disable Change of B/W Setting in Auto Mode	Disable	
▶ Initial File Format Setting		107
◆ B/W		
• File Type	PDF	
• Compression Mode	MMR (G4)	
• Specified Pages per File	Disable	
◆ Color/Gray		
• File Type	PDF	
• Compression Ratio	Medium	
• Specified Pages per File	Disable	
▶ Compression Mode at Broadcasting		107
◆ Black & White	MH (G3)	
◆ Color/Grayscale	Medium	
▶ Maximum Size of E-mail Attachments (E-mail)	Unlimited	108
▶ Maximum Size of Data Attachments (FTP/Desktop/Network Folder)	Disable	108
▶ Default Address Setting	Disable	108
▶ Bcc Setting		108
◆ Enable Bcc	Disable	
◆ Display Bcc Address on the Job Status Screen	Disable	
▶ Disable Scan Function		108
◆ PC Scan	Disable	
◆ USB Memory Scan	Disable	
▶ Pre-Setting Mail Signature	Disable	108
● I-Fax Settings*1		109
▶ I-Fax Default Settings		109
◆ I-Fax Own Name and Address Set	–	109
◆ Auto Wake Up Print	Enable	109
◆ I-Fax Speaker Volume Settings	–	109
• Receive Signal	Middle	
• Communication Error Signal	Middle	

Item	Factory default setting	Page
◆ Original Print on Transaction Report	Print Out Error Report Only	109
◆ Transaction Report Print Select Setting		110
• Single Sending	Print Out Error Report Only	
• Broadcasting	Print Out All Report	
• Receiving	No Printed Report	
◆ Activity Report Print Select Setting		110
• Auto Print at Memory Full	Disable	
• Print Daily at Designated Time	Disable	
◆ Body Text Print Select Setting	Disable	110
◆ Pre-Setting Mail Signature	Disable	110
▶ I-Fax Send Settings		111
◆ I-Fax Reception Report On/Off Setting	Disable	111
◆ I-Fax Reception Report Request Timeout Setting	1 Hour	111
◆ Number of Resend Times at Reception Error	2	111
◆ Maximum Size of E-mail Attachments (E-mail)	Unlimited	111
◆ Rotation Sending Setting	All Enable	111
◆ Printing Page Number at Receiver	Enable	111
▶ I-Fax Receive Settings		112
◆ Auto Receive Reduce Setting	Enable	112
◆ Duplex Reception Setting	Disable	112
◆ Set Address for Data Forwarding	–	112
◆ A3 RX Reduce	Disable	112
◆ POP3 Communication Timeout Setting	60 sec.	112
◆ Reception Check Interval Setting	5 min.	112
◆ Anti Junk Mail/Domain Name Setting	All Invalid	113
◆ I-Fax Output Setting*11	Varies depending on the machine configuration	113
■ Document Filing Settings		114
● Default Mode Settings	Sharing Mode	114
● Sort Method Setting	Date	114
● Document Output Options		114
▶ Print		
◆ Copy	Enable	
◆ Printer	Enable	
◆ Scan Send	Disable	
◆ I-Fax Send (Incl. PC-I-Fax)	Disable	

Item	Factory default setting	Page
◆ Fax Send (Incl. PC-Fax)	Disable	114
◆ Scan to HDD	Enable	
▶ Scan Send		
◆ Copy	Disable	
◆ Scan Send	Enable	
◆ I-Fax Send (Incl. PC-I-Fax)	Disable	
◆ Fax Send (Incl. PC-Fax)	Disable	
◆ Scan to HDD	Enable	
▶ I-Fax Send*1		
◆ Copy	Disable	
◆ Scan Send	Disable	
◆ I-Fax Send (Incl. PC-I-Fax)	Enable	
◆ Fax Send (Incl. PC-Fax)	Disable	
◆ Scan to HDD	Disable	
▶ Fax Send*2		
◆ Copy	Disable	
◆ Scan Send	Disable	
◆ I-Fax Send (Incl. PC-I-Fax)	Disable	
◆ Fax Send (Incl. PC-Fax)	Enable	
◆ Scan to HDD	Disable	
● Administrator Authority Setting		114
▶ Delete File	Disable	
▶ Delete Folder	Disable	
● Default Color Mode Settings		114
▶ Color	Auto	
▶ B/W	Mono 2	
● Default Exposure Settings		115
▶ Exposure	Auto	
▶ Original Image Type	Text	
▶ Moiré Reduction	Disable	
● Initial Resolution Setting	600X600dpi	115
● Color Data Compression Ratio Setting	Medium	115
● Default Output Tray*11	Varies depending on the machine configuration	115
● Scan Complete Sound Setting	Middle	115

Item	Factory default setting	Page
● <a href="#">Delete All Quick Files</a>		
▶ Delete	–	115
▶ Delete quick files at power up. (Protected file excluded)	Enable	
● <a href="#">Disable Stamp for Reprinting</a>	Disable	115
● <a href="#">Batch Print Settings</a>		
▶ Selection of [All Users] is not allowed.	Enable	115
▶ Selection of [User Unknown] is not allowed.	Enable	
■ <a href="#">List Print (Administrator)</a>		116
● <a href="#">Administrator Settings List</a>		
▶ Copy	–	116
▶ Print	–	
▶ Image Send	–	
▶ Document Filing	–	
▶ Security	–	
▶ Common	–	
▶ All Administrator Settings List	–	
● <a href="#">Image Sending Activity Report</a>		
▶ Image Sending Activity Report (Scanner)	–	116
▶ Image Sending Activity Report (Internet Fax)	–	
▶ Image Sending Activity Report (Fax)	–	
● <a href="#">Anti Junk Fax Number List*2</a>	–	116
● <a href="#">Anti Junk Mail/Domain Name List*1</a>	–	116
● <a href="#">Inbound Routing List</a>	–	116
● <a href="#">Document Admin List</a>	–	116
● <a href="#">Web Setting List*10</a>	–	116
● <a href="#">Metadata Set List*12</a>	–	116
■ <a href="#">Security Settings</a>		117
● <a href="#">SSL Settings</a>		
▶ HTTPS	Disable	117
▶ IPP-SSL	Disable	
■ <a href="#">Enable/Disable Settings</a>		118
● <a href="#">User Control</a>		118
▶ <a href="#">Disabling of Printing by Invalid User</a>	Disable	118

Item	Factory default setting	Page
● Operation Settings		118
▶ Cancel Auto Clear Timer	Disable	118
▶ Disabling of Job Priority Operation	Disable	118
▶ Disabling of Bypass Printing	Disable	118
▶ Disable Auto Key Repeat	Disable	118
▶ Disabling of Clock Adjustment	Disable	118
▶ Disabling of Covers/Inserts Mode	Disable	118
● Device Control		118
▶ Disabling of Document Feeder	Disable	118
▶ Disabling of Duplex	Disable	118
▶ Disabling of Large Capacity Cassette*3	Disable	118
▶ Disabling of Optional Paper Drawer*4	Disable	118
▶ Disabling of Tray Setting	Disable	119
▶ Disabling of Finisher*5	Disable	119
▶ Disabling of Offset	Disable	119
▶ Disabling of Stapler*5	Disable	119
▶ Disabling of Punch*7	Disable	119
▶ Disabling of Color Mode*8	Disable	119
▶ Disabling of Master Machine Mode	Disable	119
▶ Disabling of Slave Machine Mode	Disable	119
● Copy Settings		119
▶ Disable Copy in Different Size/Direction	Disable	119
▶ Disabling Deletion of Job Programs	Disable	119
▶ Disabling of Bypass-Tray in Duplex Copy	Disable	119
▶ Disabling of Auto Paper Selection	Disable	120
● Printer settings		120
▶ Prohibit Notice Page Printing	Enable	120
▶ Prohibit Test Page Printing	Disable	120
▶ Exclude Bypass-Tray from Auto Paper Select	Disable	120
● Image Send Settings		120
▶ Disable Switching of Display Order	Disable	120
▶ Disable Scan Function		120
◆ PC Scan	Disable	
◆ USB Memory Scan	Disable	

Item	Factory default setting	Page
▶ Settings to Disable the Registration of Destination		120
◆ Disable Registering Destination from Operation Panel		120
• Group	Disable	
• E-mail	Disable	
• Internet Fax	Disable	
• Fax	Disable	
◆ Disable Registering Destination on Web Page*10		120
• Group	Disable	
• E-mail	Disable	
• FTP	Disable	
• Desktop	Disable	
• Network Folder	Disable	
• Internet Fax	Disable	
• Fax	Disable	
◆ Disable Registration Using Network Scan Tools*10	Disable	120
▶ Settings to Disable Transmission		121
◆ Disable [Resend] on Fax/Image Send Mode	Disable	121
◆ Disable selection from the Address Book		121
• E-mail	Disable	
• FTP	Disable	
• Desktop	Disable	
• Network Folder	Disable	
• Internet Fax	Disable	
• Fax	Disable	
◆ Disable Direct Entry		121
• E-mail	Disable	
• Internet Fax	Disable	
• Fax	Disable	
◆ Disable PC-I-Fax Transmission*1	Disable	121
◆ Disable PC-Fax Transmission*2	Disable	121
● Document Filing Settings		121
▶ Disable Stamp for Reprinting	Disable	121
▶ Batch Print Settings		121
◆ Selection of [All Users] is not allowed.	Enable	
◆ Selection of [User Unknown] is not allowed.	Enable	

Item	Factory default setting	Page
■ <b>Change Administrator Password</b>	See "TO THE ADMINISTRATOR OF THE MACHINE" in the Safety Guide.	122
■ <b>Product Key</b> *13		123
● Network Scanner Expansion Kit	–	123
● Printer Expansion Kit	–	123
● PS3 Expansion Kit	–	123
● Internet Fax Expansion Kit	–	123
● E-mail Alert and Status	–	123
● Application Integration Module	–	123
● Serial Number	–	123
■ <b>Storing/Calling of System Settings</b>		124
● Restore Factory Defaults	–	124
● Store Current Configuration	–	124
● Restore Configuration	–	124

The following items are explained in "11. SYSTEM SETTINGS FOR FAX" in the Facsimile Guide.

Item	Factory default setting
■ <b>Image Send Settings</b>	
● Fax Settings*2	
▶ Fax Default Settings	
◆ Fax Own Name and Number Set	–
◆ Dial Mode Setting	Tone
◆ Auto Wake Up Print	Enable
◆ Pause Time Setting	2 sec.
◆ Speaker Settings	
• Speaker	Volume: Middle
• Ringer Volume	Volume: Middle
• Line Monitor	Volume: Middle
• Fax Receive Complete Signal	Volume: Middle; Tone Pattern: 3; Transmission Complete Sound Time Setting: 3 sec.
• Fax Send Complete Signal	Volume: Middle; Tone Pattern: 3; Transmission Complete Sound Time Setting: 3 sec.
• Fax Communication Error Signal	Volume: Middle; Tone Pattern: 3; Transmission Complete Sound Time Setting: 0.3 sec.



Item	Factory default setting
◆ Remote Reception Number Setting	5
◆ Original Print on Transaction Report	Print Out Error Report Only
◆ Transaction Report Print Select Setting	
• Single Sending	Print Out Error Report Only
• Broadcasting	Print Out All Report
• Receiving	No Printed Report
• Confidential Reception	Print Out Notice Page
◆ Activity Report Print Select Setting	
• Auto Print at Memory Full	Disable
• Print Daily at Designated Time	Disable
◆ ECM	Enable
◆ Distinctive Ring Detection	Off
▶ Fax Send Settings	
◆ Auto Reduction Sending Setting	Enable
◆ Rotation Sending Setting	All Enable
◆ Quick On Line Sending	Enable
◆ Printing Page Number at Receiver	Enable
◆ Date/Own Number Print Position Setting	Outside the Original Image
◆ Registration of Own Name Select	–
◆ Recall in Case of Line Busy	Recall, Times: twice, Interval: 3 min.
◆ Recall in Case of Communication Error	Recall, Times: once, Interval: 3 min.
▶ Fax Receive Settings	
◆ Number of Calls in Auto Reception	2
◆ Duplex Reception Setting	Disable
◆ Auto Receive Reduce Setting	Enable
◆ Print Style Setting	Auto Size Select
◆ Set the Telephone Number for Data Forwarding	–
◆ A3 RX Reduce	Disable
◆ Anti Junk Fax Setting	–
◆ Fax Output Settings	Varies depending on the machine configuration

Item	Factory default setting
▶ Fax Polling Security	
◆ Polling Security Setting	Enable
◆ Passcode Number Setting	-

\*1 When the Internet fax expansion kit is installed.

\*2 When the facsimile expansion kit is installed.

\*3 When a large capacity tray is installed.

\*4 When a paper drawer is installed.

\*5 When a saddle stitch finisher or finisher is installed.

\*6 When a saddle stitch finisher is installed.

\*7 When a punch module is installed.

\*8 When a color-related problem has occurred.

\*9 When the PS3 expansion kit is installed.

\*10 When network connection is enabled.

\*11 When a right tray is installed.

\*12 When the application integration module is installed.

\*13 Depending on the peripheral devices installed, it may not be possible to use some settings.

---

---

# User Control

This is used to configure settings for user authentication. Touch the [User Control] key and configure the settings.

---

## User Authentication Setting

These settings enable or disable user authentication and specify the authentication method.

When user authentication is enabled, each user of the machine is registered. When a user logs in, settings for that user are applied. This function allows greater control of security and cost management than on previous machines.

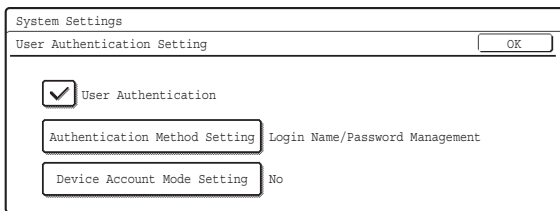

### • User Authentication

To enable user authentication, select the [User Authentication] checkbox  and touch the [OK] key. When the [User Authentication] checkbox is selected , a login screen appears when any mode other than the job status screen\* is selected. Log in using your stored user information. (For the procedure for storing users, see "User Registration" (page 81).)

After logging in, you can move freely through the modes. For the login procedure in the login screen, see "When User Authentication is Enabled" (page 6).

\* Note that the login screen will appear when a file stored by document filing is used or a broadcast transmission is re-attempted from the job status screen.

### • Authentication Method Setting

To select one of the following authentication methods, touch the [Authentication Method Setting] key after selecting the [User Authentication] checkbox . Select the desired key and touch the [OK] key.

- Authenticate a User by Login Name and Password:  
This method is required when network authentication is used.
- Authenticate a User by Login Name, Password and E-mail Address:  
This is used when LDAP3 is configured and e-mail addresses are used for authentication.
- Authenticate a User by User Number Only:  
This can be used as a simple login method when network authentication is not used.

### • Device Account Mode Setting

A specific user can be stored as an auto login user. When this setting is enabled, login can be performed automatically.

This function saves you the bother of logging in but still allows the settings of the selected user (network settings, favorite operations, etc.) to be applied.

To store a user for auto login, touch the [Device Account Mode Setting] key after selecting the [User Authentication] checkbox .

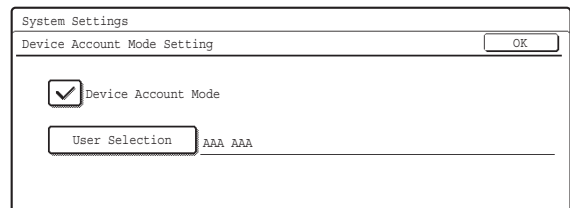

Select the [Device Account Mode] checkbox  and touch the [User Selection] key. The user selection screen will appear. Select the auto login user. An authentication screen will appear for confirmation purposes after the auto login user is selected. Enter the password to complete the setting.



- The login screen will vary depending on the authentication method that is selected. For more information, see "When User Authentication is Enabled" (page 6).
- Be sure to set the authentication method before registering users. When users are registered, information will be configured for each user (login name, password, etc.) based on the selected authentication method.
- When "Authenticate a User by User Number Only" is selected for the authentication method, network authentication cannot be used.
- If auto login fails for some reason when auto login is enabled, or the login user does not have administrator rights, all system settings or the system settings (administrator) will lock. In this event, the administrator should touch the [Admin Password] key in the system settings screen and log in again.

# User Registration

This is used to store, edit, and delete users when user authentication is enabled.

Touch one of the following keys:

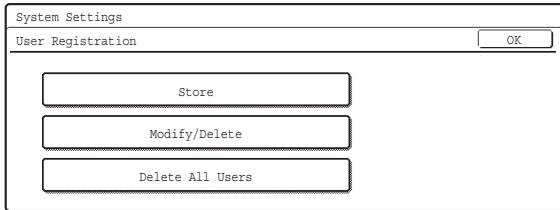

## Store

Up to 200 users can be stored, excluding factory-stored users (Administrator, Standard User, Other User).

### 1 Touch each key and enter the required information.

For more information, see "Items stored" (page 82).

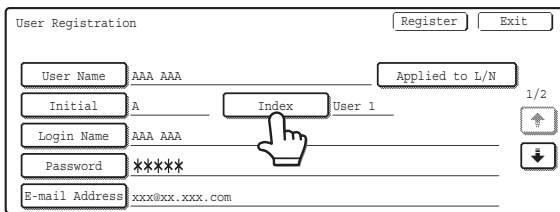

### 2 Touch the [Register] key.

### 3 Touch the [Exit] key.

To store another user, touch the [Next] key and repeat the procedure from step 1.

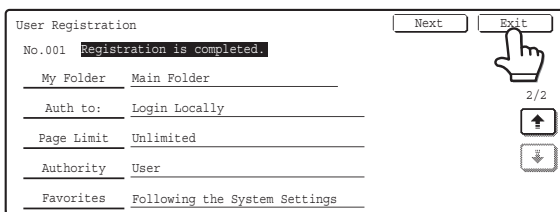

The lowest number, 001 to 200, that has not yet been programmed automatically appears in "No." in the top left corner of the screen. The number stored here is used when the user is specified with the key. It is convenient to memorize each user's number.

## Modify/Delete

### 1 Select the user.

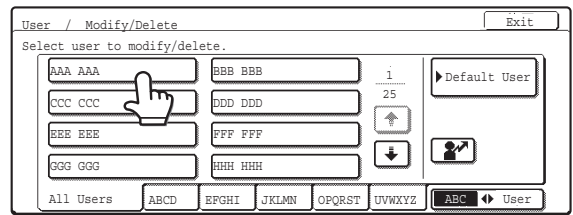

### 2 Edit or Delete

#### To edit

(A) Touch the desired items and edit the items in the same way as you stored them and then touch the [Modify] key.

#### To delete

(B) Touch the [Delete] key.

A message will appear to confirm the deletion. Touch the [Yes] key.

\* Default users and the user that is specified as the auto login user cannot be deleted.

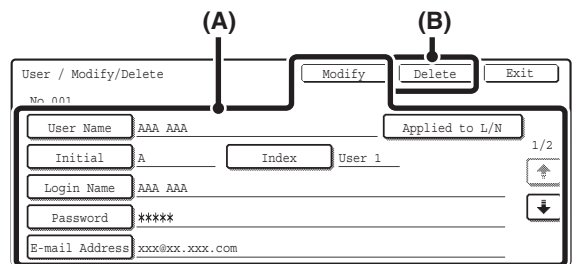

## Delete All Users

All users can be deleted. This operation can only be performed by an administrator. Touch the [Delete All Users] key in the "User Registration" screen. A confirmation screen will appear. Touch the [Yes] key.



When auto login is enabled, "Delete All Users" cannot be used. The factory-stored users cannot be deleted.

## Items stored

See the table below for the items that are stored. Some items must be entered before the keys of other items can be selected. Enter items whose keys can be selected first.

<b>User Name*1</b>	Store the name of the user (max. 32 characters). This user name will be used for the key name in the login screen, the user name for document filing, and the sender name. (More than one user cannot have the same user name.)
<b>Applied to L/N</b>	Touch this key to enter the stored user name in the login name.
<b>Initial*1</b>	This determines where the user name will appear in the user list. The first 10 characters of the user name are automatically entered. (The initials can be changed.)
<b>Index*1</b>	Select the custom index. The custom index names are shared with the custom indexes of the address book.
<b>Login Name</b>	Enter the login name used when authentication by login name/password is enabled (maximum of 255 characters). (The login name must be unique.)
<b>Password*2</b>	Enter the password used when authentication by login name/password is enabled (1 to 32 characters). (Can be omitted.)
<b>E-mail Address</b>	Enter the e-mail address used in the sender list and for LDAP authentication (maximum of 64 characters).
<b>My Folder</b>	A folder ("My Folder") can be specified as the folder used by the user for document filing. A previously created folder can be selected or you can create and select a new folder.
<b>Auth to:</b>	Select [Login Locally] or [Network Authentication] (when LDAP is enabled) for "Authenticate to:". If [Network Authentication] is selected, the LDAP servers stored in the Web pages will appear. Select the server that you wish to use for authentication.

<b>Page Limit</b>	Specify page limits for the user by selecting one of the stored page limit groups. The factory default setting is "Unlimited". For more information, see " <a href="#">Pages Limit Group Registration</a> " (page 83).
<b>Authority</b>	Specify the authority of the user by selecting one of the stored authority groups. The factory default setting is "User". For more information, see " <a href="#">Authority Group Registration</a> " (page 84).
<b>Favorites</b>	Select one of the stored Favorite Operation Groups to specify the operation settings that will be applied when you log in. The factory default setting is "Following the System Settings". For more information, see " <a href="#">Favorite Operation Group Registration</a> " (page 86).

\*1 Entry of this item is required.

\*2 When network authentication is used, an LDAP password will be used and thus there is no need to configure this setting.



- When "Authentication Method Setting" is set to "Authenticate a User by User Number Only", the items change as follows:  
"Login Name" and "Password" change to "User Number" (5 to 8 digits).  
"Applied to L/N" does not appear.  
"Auth to:" does not appear.
- For the procedure for entering text, see "6. ENTERING TEXT" in the User's Guide.

## Pages Limit Group Registration

This is used to store groups of Account Limit Settings. The page limits for each user are specified by selecting one of these stored groups when the user is stored.

### Storing groups

Up to 8 groups can be stored.

#### 1 Select a group that is blank.

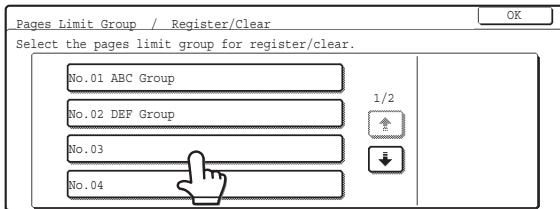

#### 2 Touch the [Group Name] key and enter a group name.

Up to 32 characters can be entered for the name. After you have entered the name, touch the [OK] key.

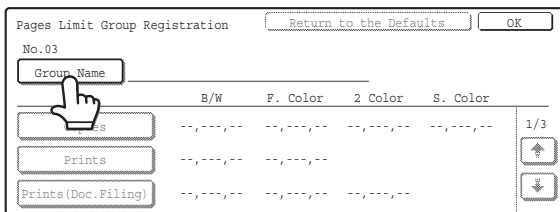

#### 3 Touch the items and specify the settings.

When a key is touched, a screen to enter the limit appears. Select the desired keys, enter numbers with the numeric keys, and touch the [OK] key.

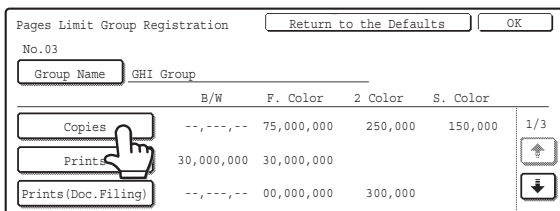

#### 4 Touch the [OK] key.

### Edit or Delete

#### 1 Select a stored group.

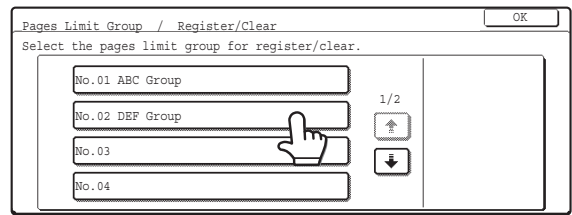

#### 2 Edit or delete the group.

##### To edit

(A) Touch each item and edit the items in the same way as they were stored and then touch the [OK] key.

##### To delete

(B) Touch the [Return to the Defaults] key. A message will appear. Touch the [Yes] key. The page limit setting of users that specified this group will change to "Unlimited".

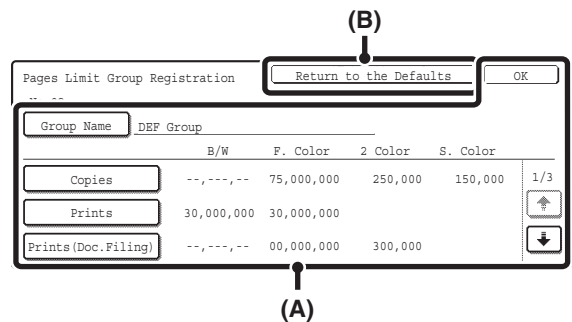

For the procedure for entering text, see "6. ENTERING TEXT" in the User's Guide.

## Actions when the Limit of Pages for Output Jobs

This setting determines whether or not a job will be completed if the page limit is reached while the job is in progress.

Select the desired key and touch the [OK] key.

- Job is Stopped when the Limit of Pages is Reached
- Job is Completed even when the Limit of Pages are Reached

## Authority Group Registration

Use this to store groups of user authority settings. The authority of each user is specified by selecting one of these stored groups when the user is stored.

### Storing groups

Up to 8 groups can be stored.

#### 1 Select a group that is blank.

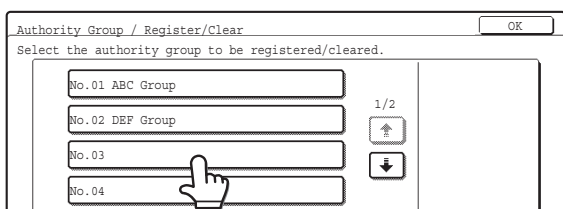

#### 2 Touch the [Group Name] key and enter a group name.

Up to 32 characters can be entered for the name. After you have entered the name, touch the [OK] key.

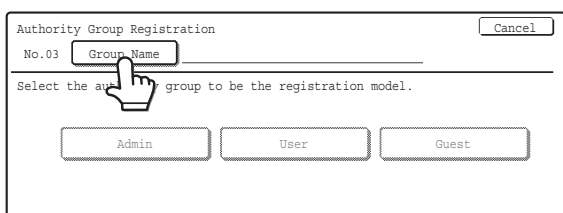

#### 3 Touch the authority group key that you wish to use as a template for the new group.

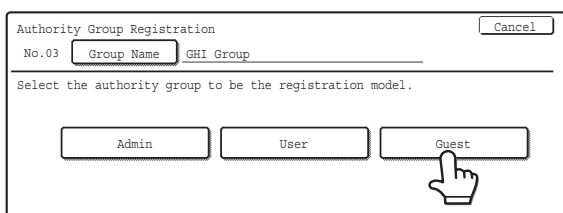

#### 4 Touch the items and specify the settings.

For more information on the settings, see "[List of settings and factory default settings of template groups](#)" (page 85).

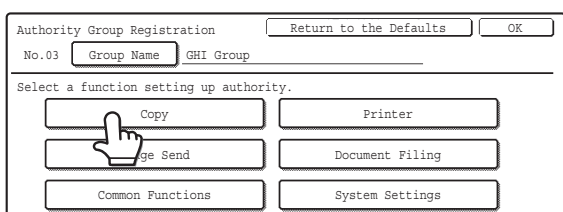

#### 5 Touch the [OK] key.

### Edit or delete the group.

#### 1 Select a stored group.

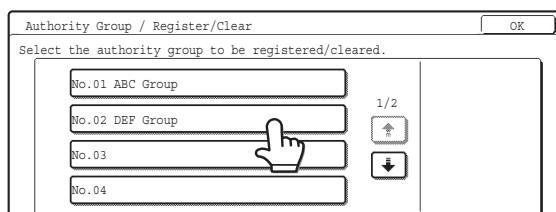

#### 2 Edit or delete the group.

##### To edit

(A) Touch the desired items and edit them in the same way as they were stored. When finished, touch the [OK] key.

##### To delete

(B) Touch the [Return to the Defaults] key. The template selection screen will appear. Touch one of the keys. A message will appear. Touch the [Yes] key. The authority group setting of users that specified this group will change to the selected factory-stored authority group.

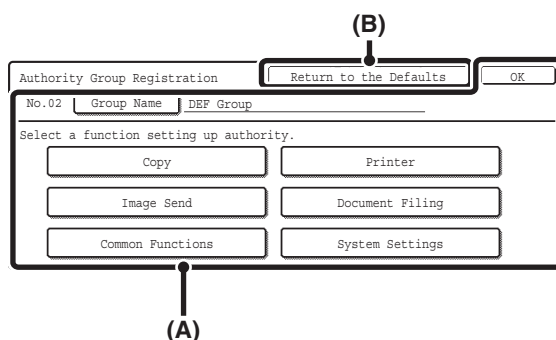

For the procedure for entering text, see "6. ENTERING TEXT" in the User's Guide.

## List of settings and factory default settings of template groups



Depending on the machine specifications and peripheral devices installed, it may not be possible to use some settings.

Item	Factory-stored authority group		
	Admin	User	Guest
<b>Copy</b>			
Color Mode Approval Setting	All Allowed	All Allowed	Only Black & White Allowed
Special Modes Approved	Allowed	Allowed	Prohibited
<b>Printer</b>			
Color Mode Approval Setting	Allowed	Allowed	Only Black & White Allowed
USB Memory Direct Print Approved	Allowed	Allowed	Prohibited
FTP Pull Print Approved	Allowed	Allowed	Prohibited
<b>Image Send</b>			
Approval Settings for Each Mode			
<ul style="list-style-type: none"> <li>E-mail</li> <li>FTP</li> <li>Desktop</li> <li>Network Folder</li> <li>USB Memory</li> <li>PC Scan</li> <li>Internet Fax</li> <li>PC-I-Fax</li> <li>Fax</li> <li>PC-Fax</li> </ul>	All Allowed		
Color Scan Approval	Allowed	Allowed	Prohibited
Special Modes Approved	Allowed	Allowed	Prohibited
Approval Setting for Addressing			
<ul style="list-style-type: none"> <li>Approval Setting for Direct Entry</li> <li>Approval Setting to Use a Local Address Book</li> <li>Approval Settings to Use a Global Address Book</li> </ul>	All Allowed		
<b>Document Filing</b>			
Scan to HDD			
Color Mode Approval Setting	All Allowed	All Allowed	Only Black & White Allowed
Special Modes Approved	Allowed	Allowed	Prohibited

Item	Factory-stored authority group		
	Admin	User	Guest
Document Filing Print			
<ul style="list-style-type: none"> <li>Color Mode Approval Setting</li> </ul>	All Allowed	All Allowed	Only Black & White Allowed
<ul style="list-style-type: none"> <li>Special Modes Approved</li> </ul>	Allowed	Allowed	Prohibited
<b>Common Functions</b>			
Approval Settings for 2-Sided Print	[1-Sided/2-Sided Approved]		
<b>System Settings</b>			
System Settings			
System Settings*1	Allowed*2	Only user authority settings allowed*3	All settings prohibited
<b>Web Settings</b>			
Display Device/Network Status	Allowed	Allowed	Prohibited
Power Reset		Prohibited	
Machine Identification		Prohibited	
Network Settings		Prohibited	
Application Settings (Pre-set Text/Forward Table Excluded)		Prohibited	
Registration of Pre-Set Text/Forward Table		Allowed	
E-mail Alert and Status		Prohibited	
Job Log		Prohibited	
Port Settings/Filter Settings		Prohibited	
Storage Backup		Prohibited	
Custom Links		Prohibited	
Operation Manual Download		Allowed	

\*1 For information on each setting, see the system settings (general/administrator) lists.

\*2 Permission except Changing Administrator Password

\*3 Changes to part of the user information are possible only for the logged in user.



# Favorite Operation Group Registration

A group of customized settings can be stored for each user. For example, a user who speaks a different language would normally have to change the display language each time he or she uses the machine; however, by storing the language in a favorite operation group, the language is automatically selected when the user logs in.

The customized settings of each user are specified by selecting one of these stored groups when the user is stored.

## Storing groups

Up to 8 groups can be stored.

### 1 Select a group that is blank.

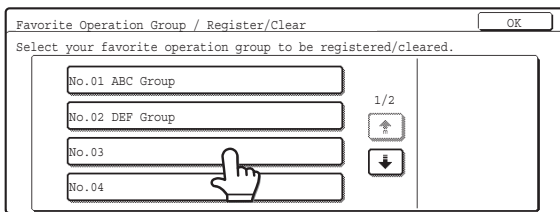

### 2 Touch the [Group Name] key and enter a group name.

Up to 32 characters can be entered for the name. After you have entered the name, touch the [OK] key.

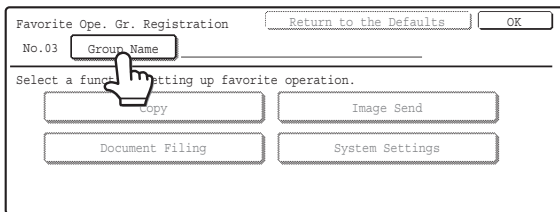

### 3 Touch the items and specify the settings.

For more information on the settings, see ["Items stored in favorite operation groups"](#) (page 87).

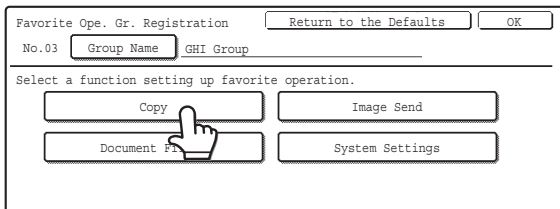

### 4 Touch the [OK] key.

## Edit or delete the group.

### 1 Select a stored group.

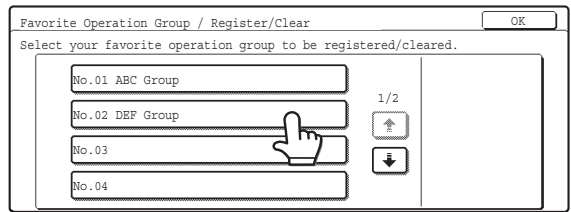

### 2 Edit or delete the group.

#### To edit

(A) Touch the desired items and edit them in the same way as they were stored. When finished, touch the [OK] key.

#### To delete

(B) Touch the [Return to the Defaults] key. A message will appear. Touch the [Yes] key. The customized settings of users that specified this group will change to "Following the System Settings".

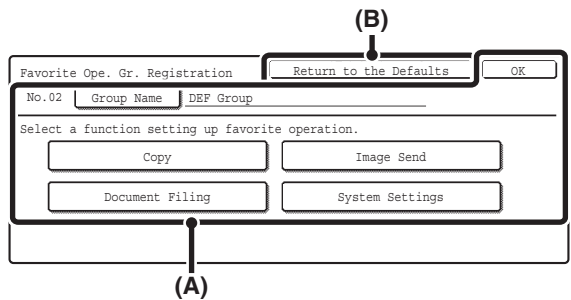

For the procedure for entering text, see "6. ENTERING TEXT" in the User's Guide.

## Items stored in favorite operation groups

Item	Settings
<b>Copy</b>	
Initial Status Settings	Select settings for Color Mode, Paper Tray, Exposure Type, Copy Ratio, Duplex, and Output.
<b>Image Send</b>	
Initial Status Settings	Select settings for Resolution, Exposure, and File Format.
Fax Default Own Number and Name Setting	Store the default fax sender name and number.
<b>Document Filing</b>	
Scan to HDD: Initial Status Settings	Select settings for Color Mode, Resolution, Exposure, and Compression Ratio.
Document Filing Print: Default Output Tray Setting	Set the default output tray for document filing.
<b>System Settings</b>	
Display Language Setting	Set the display language.
Key Operation Setting	Set the time to key touch entry and Auto Key Repeat setting.
Keys Touch Sound	Set the sound made when keys are touched.
Customize Key Setting	Set customized keys for each mode.
Original Size Detector Setting	Select whether inch sizes or AB sizes are detected, or disable detection on the document glass.

## User Count Display

This displays the total number of pages printed by each user.

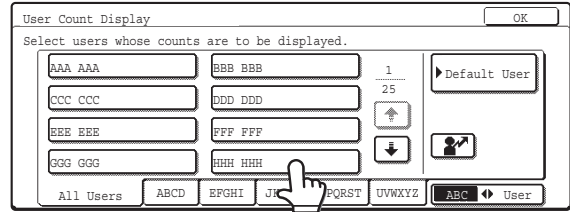

Select the desired user.

When the user is selected, the following screen will appear.

	B/W	F. Color	2 Color	S. Color
Copies	24,681,000	36,914,712	10,032,101	3,279,420
(Page Limit)	(--,---,---)	(37,000,000)	(37,000,000)	(37,000,000)
Prints	14,736,932	00,000,000		
(Page Limit)	(--,---,---)	(00,000,000)		
Prints (Doc.Filing)	11,223,421	62,569,875	787,070	
(Page Limit)	(--,---,---)	(--,---,---)	(--,---,---)	

Misfed paper is not included in the counts. When fax, Internet fax, or network scan is used, the transmitted page count is also displayed.



Counts of devices that are not installed do not appear.

## User Count Reset

Use this to reset user counts to "0".

- (A) To reset the counts of a selected user, select the user and touch the [Selected User] key.
- (B) To reset the counts of all users, touch the [All Users] key.

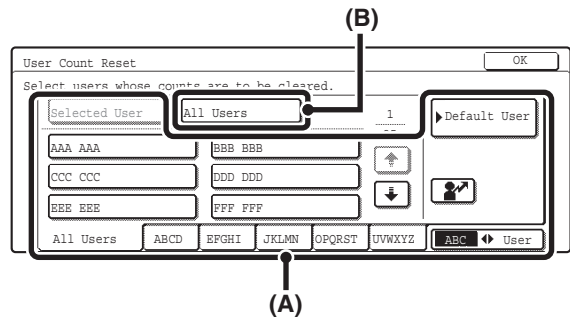

**• When the single user is selected**

Touch the counts that you wish to reset and touch the [Reset Selected] key. To reset all counts, touch the [Reset All] key with no counts selected.

	B/W	F. Color	2 Color	S. Color
Copies	24,681,000	36,914,712	10,032,101	3,279,420
(Page Limit)	(---,---,---)	(37,000,000)	(37,000,000)	(37,000,000)
Prints	14,736,932	00,000,000		
(Page Limit)	(---,---,---)	(00,000,000)		
Prints (Doc. Filing)	11,223,421	62,569,875	787,070	
(Page Limit)	(---,---,---)	(---,---,---)	(---,---,---)	

**• When multiple users are selected**

Select the checkboxes  of counts that you wish to reset and touch the [Reset Selected] key. To reset all counts, touch the [Reset All] key with no counts selected.

	B/W	F. Color	2 Color	S. Color
Copies	<input type="checkbox"/>	<input type="checkbox"/>	<input type="checkbox"/>	<input type="checkbox"/>
Prints	<input type="checkbox"/>	<input type="checkbox"/>		
Prints (Doc. Filing)	<input type="checkbox"/>	<input type="checkbox"/>	<input type="checkbox"/>	

The display of the [Reset Selected] and [Reset All] keys will vary depending on whether or not counts are selected.

## User Information Print

The following lists can be printed.

- All User Information Print
- User List
- List of Number of Pages Used
- Page Limit Group List\*
- Authority Group List
- Favorite Operation Group List\*

Touch the key of the desired list to begin printing.

\* Cannot be printed when no groups are stored.

## The Number of User Name Displayed Setting

The number of users that are displayed in the user selection screen can be selected (6, 8, or 12 users). Select one of the keys and touch the [OK] key.

This setting also applies to the user selection screen of document filing and the sender selection screen.

## A Warning when Login Fails

This setting is used to display a warning and prohibit login for five minutes if login fails three times in a row. This prevents an unauthorized person from attempting to guess a password. (The number of failed login attempts is retained even if the power is turned off.) To enable this setting, select the checkbox  and touch the [OK] key.

The 5-minute operation lock state can be cleared in the screen that appears when [User Control] > [Default Settings] is selected in the Web page menu.

## Disable Printing by Invalid User

Printing by users who do not enter valid user information in the printer driver or who are not stored in the machine for FTP push print or other direct print jobs can be prohibited. To enable this setting, select the checkbox  and touch the [OK] key.

## Default Network Authentication Server Setting

Use this to set the default network authentication destination. When a user logs in from the Web page or sends a print job to the machine using user information that is not stored on the machine, the authentication destination is not known. This setting is used to specify one of the LDAP servers stored on the machine as the authentication destination. Highlight the key of the desired server and touch the [OK] key. To cancel the selection, touch the [Cancel] key.

---

---

# Energy Save

The Energy Save settings help reduce power costs. From an environmental perspective, these settings also help reduce pollution and conserve natural resources. Touch the [Energy Save] key and configure the settings.

---

## Toner Save in Printer Mode

Toner Save mode can be enabled to reduce toner consumption when printing. This setting is only effective for printing that does not use the printer driver. When the printer driver is used, the printer driver setting takes precedence.

To enable this setting, select the checkbox  and touch the [OK] key.

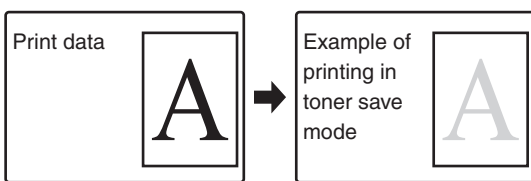

 This setting may not operate in some applications and operating systems.

---

## Toner Save in Copy Mode

This setting is used to save toner in copy mode. This setting functions the same way as toner save in printer mode.

---

## Auto Power Shut-Off

This setting enables or disables Auto Power Shut-Off. To disable Auto Power Shut-Off, touch the checkbox so that a checkmark does not appear  and touch the [OK] key. Remove the checkmark if you prefer that Auto Power Shut-Off does not operate.

When the set duration of time elapses after printing ends, Auto Power Shut-Off activates and causes the machine to go on standby at a minimal level of power consumption.

This function reduces your power costs, and at the same time helps conserve natural resources and reduce pollution.

If you prefer that auto power shut-off activates as little as possible, it is recommended that you try lengthening the time setting after which activation takes place rather than disabling the function altogether. (The time setting for activation of Auto Power Shut-Off is selected using the following "[Auto Power Shut-Off Timer](#)" setting.)

---

## Auto Power Shut-Off Timer

The time until Auto Power Shut-Off activates can be set to any number of minutes from 1 to 240.

Specify the time with the   keys and touch the [OK] key. (To make the number change quickly, keep your finger on the  or  key.)

Select the time that best suits your workplace needs.

 The timer setting will not be effective if Auto Power Shut-Off is disabled using the "[Auto Power Shut-Off](#)" setting.

---

## Preheat Mode Setting

The time until Preheat Mode activates can be set to any number of minutes from 1 to 240.

Specify the time with the   keys and touch the [OK] key. (To make the number change quickly, keep your finger on the  or  key.)

Preheat Mode will activate when the duration of time specified with this setting elapses after printing ends and no further operations are performed. This function reduces your power costs, and at the same time helps conserve natural resources and reduce pollution. Select the time that best suits your workplace needs.

 Preheat mode cannot be disabled.

# Operation Settings

Settings related to machine operation can be configured. Touch the [Operation Settings] key and configure the settings.

## Keys Touch Sound

This setting is used to adjust (or turn off) the volume of the beep that sounds when you touch a key. You can also have three beeps sound at initial values when setting the ratio in copy mode or when adjusting the exposure in any mode.

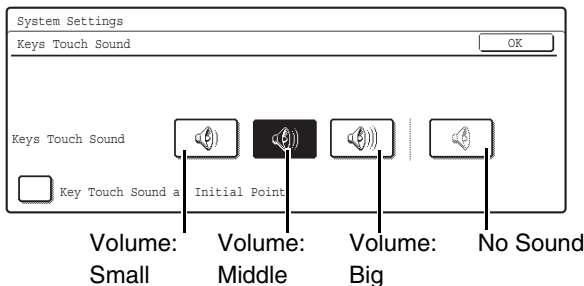

Select one of the keys and touch the [OK] key. When "Key Touch Sound at Initial Point" is selected , three beeps will sound at the initial values indicated below.

Screen in which setting is effective	Initial value
Ratio setting screen in base screen of copy mode	Ratio 100%
Exposure adjustment screen in base screen of copy mode	Exposure level 3 (middle level)
Exposure adjustment screen in base screen of fax, Internet fax, and network scanner modes	
Exposure adjustment screen in [Scan to HDD] in base screen of document filing mode	

## Auto Clear Setting

The time until Auto Clear activates can be set to any number of minutes from 10 to 240.

Make sure the [Cancel Timer] checkbox is not selected , specify the time with the   keys, and touch the [OK] key. (To make the number change quickly, keep your finger on the  or  key.)

If the machine is not used for the duration of time set here, the auto clear function will clear any settings that have been selected and return the screen to the base screen of copy mode or the job status screen.

If you do not want Auto Clear to operate, select the [Cancel Timer] checkbox .

## Message Time Setting

The duration of time that messages appear in the display (the time until a message is automatically cleared) can be set to any number of seconds from 1 to 12.

Specify the time with the   keys and touch the [OK] key. (To make the number change quickly, keep your finger on the  or  key.)

## Display Language Setting

The language that appears in the display can be changed.

Select one of the keys and touch the [OK] key.



When user authentication is enabled, the display language setting is given priority when it is configured in the favorite operation group.

## Disabling of Job Priority Operation

The job priority function can be disabled. When this is done, the [Priority] key will not appear in the job status screen.

To enable this setting, select the checkbox  and touch the [OK] key.

---

## Disabling of Bypass Printing

This setting is used to disable bypass printing (printing other jobs ahead of a job that has been stopped\* because the paper required for the job is not in any of the trays).

To enable this setting, select the checkbox  and touch the [OK] key.

\* This does not include cases where the paper ran out during the job.

---

## Key Operation Setting

This setting determines how long a key in the touch panel must be touched until the key input is registered. The time can be set from 0 to 2 seconds in increments of 0.5 seconds.

By lengthening the time setting, key input can be prevented when a key is touched accidentally. Keep in mind, however, that when a longer setting is selected more care is required when touching keys to ensure that key input is registered.

Specify the time with the   keys and touch the [OK] key. (To make the number change quickly, keep your finger on the  or  key.)

To disable auto repeat of key input, select the [Disable Auto Key Repeat] checkbox  and touch the [OK] key.



The touch panel contains keys such as the zoom keys (for setting the ratio) that can be touched continuously to make a value change until it reaches a desired value. This feature whereby a value changes continuously while your finger is on the key is called key repeat.

---

## Disabling of Clock Adjustment

This setting is used to prohibit changing of the date and time.

To enable this setting, select the checkbox  and touch the [OK] key.

---

## Disabling of Covers/Inserts Mode

This setting is used to prohibit the use of the covers and inserts function.

To enable this setting, select the checkbox  and touch the [OK] key.

---

## Customize Key Setting

Short-cuts to functions that are frequently used can be displayed as keys in the lower right corner of the base screen of each mode.

### 1 Touch the key of the mode for which you wish to configure the customized keys.

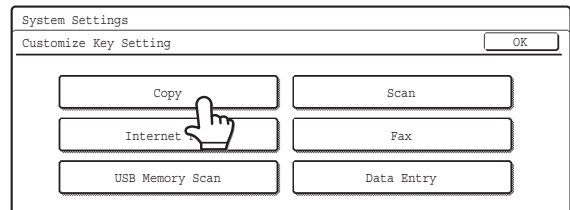

### 2 Touch the key that you wish to configure.

To return all of the customized key settings to the factory default settings, touch the [Back to Default] key.

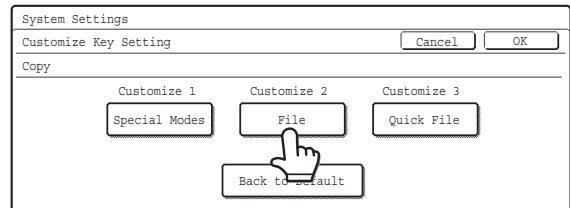

### 3 Touch the [Setup Items] key.

If you do not want the selected customized key to appear in the base screen, select the [No Display] checkbox .

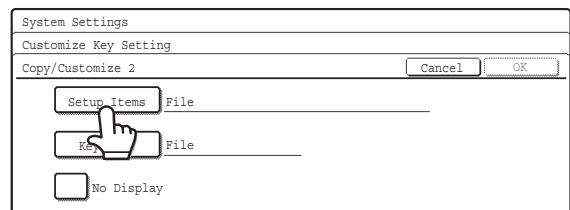

#### 4 Select the function that you wish to show in the customized key.

Select the key of the desired function and touch the [OK] or the [Details] key. Touch the [Details] key to open the advanced settings screen for the selected function. Select the desired settings and touch the [OK] key.

When the [OK] key is touched, a confirmation message will appear. Touch the [Yes] key to apply the selected function name to the customized key. (The name of the key can also be changed.)

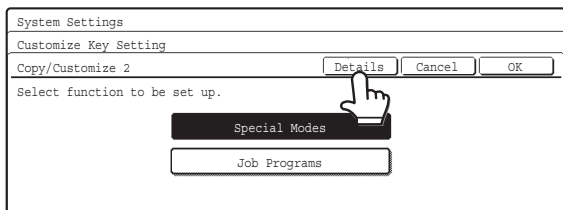

#### 5 Touch the [OK] key.

If you wish to change the name of the customized key, touch the [Key Name] key and enter the desired name.

The customized keys in the base screen of the selected mode will change to reflect the settings.

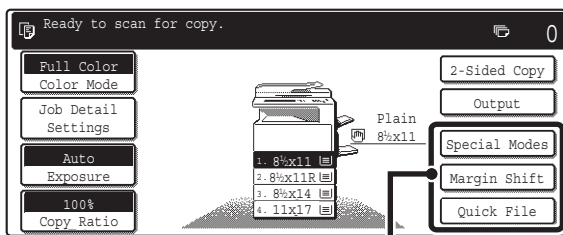

Customize key

# Device Control

These settings control devices installed on the machine. Touch the [Device Control] key and configure the settings.

## Original Size Detector Setting

One of the five groups of standard original sizes shown below can be selected for detection by the original size detection function.

Select one of the keys and touch the [OK] key.

Selections	Detectable original sizes	
	Document glass	Document feeder tray (automatic document feeder)
AB-1	A3, A4, A4R, A5, B4, B5, B5R	A3, A4, A4R, A5, B4, B5, B5R, 8-1/2" x 11", 8-1/2" x 14", 11" x 17"
AB-2	A3, A4, A4R, A5, B5, B5R 216 mm x 330 mm (8-1/2" x 13")	A3, A4, A4R, A5, B4, B5, B5R, 8-1/2" x 11", 11" x 17", 216 mm x 330 mm (8-1/2" x 13")
AB-3	A4, A4R, A5, B4, 8K, 16K, 16KR	A3, A4, A4R, A5, B4, 8K, 16K, 16KR, 8-1/2" x 11", 11" x 17", 216 mm x 330 mm (8-1/2" x 13")
INCH-1	11" x 17", 8-1/2" x 14", 8-1/2" x 11", 8-1/2" x 11"R, 5-1/2" x 8-1/2"	11" x 17", 8-1/2" x 14", 8-1/2" x 11", 8-1/2" x 11"R, 5-1/2" x 8-1/2", A4, A3
INCH-2	11" x 17", 8-1/2" x 13" (216 mm x 330 mm), 8-1/2" x 11", 8-1/2" x 11"R, 5-1/2" x 8-1/2"	11" x 17", 8-1/2" x 13" (216 mm x 330 mm), 8-1/2" x 11", 8-1/2" x 11"R, 5-1/2" x 8-1/2", A4, A3

To disable detection of original sizes on the document glass, select the [Cancel Detection at Document Glass] checkbox  and touch the [OK] key.



If "Cancel Detection at Document Glass" is selected, all originals placed on the document glass will be treated as special size originals.

## Disabling of Document Feeder

Use this setting to prohibit the use of the automatic document feeder, such as when the feeder malfunctions. (When the setting is enabled, scanning is still possible using the document glass.)

To enable this setting, select the checkbox  and touch the [OK] key.

## Original Feeding Mode

The following original feeding modes can be set to operate by default in copy, Scan to HDD, and image send modes. When a mode is frequently used, this saves you from having to select the mode in the special modes each time it is used.

- Mixed Size Original (Same Width/Different Width)
- Slow Scan Mode

	Mixed Size Doc. Same Width	Mixed Size Doc. Different Width	Slow Scan Mode
Copy	<input type="checkbox"/>	<input type="checkbox"/>	<input type="checkbox"/>
Scan to HDD	<input type="checkbox"/>	<input type="checkbox"/>	<input type="checkbox"/>
Image Send	<input type="checkbox"/>	<input type="checkbox"/>	<input checked="" type="checkbox"/>

To use this setting, select the checkboxes  of the desired items and touch the [OK] key.

## Disabling of Duplex

This is used to disable two-sided printing, such as when the duplex module malfunctions.

To enable this setting, select the checkbox  and touch the [OK] key.

## Disabling of Large Capacity Cassette

(When a large capacity tray is installed.)

This setting is used to prohibit the use of the large capacity tray, such as when the cassette malfunctions.

To enable this setting, select the checkbox  and touch the [OK] key.



---

## Disabling of Optional Paper Drawer

**(When an optional paper drawer is installed.)**

This setting is used to disable the optional paper drawer, such as when it malfunctions.

To enable this setting, select the checkbox  and touch the [OK] key.

---

## Disabling of Tray Setting

This setting is used to prohibit tray (except bypass tray) settings.

To enable this setting, select the checkbox  and touch the [OK] key.

---

## Disabling of Finisher

**(When a saddle stitch finisher or finisher is installed.)**

This setting is used to disable the saddle stitch finisher or finisher, such as when the unit malfunctions.

To enable this setting, select the checkbox  and touch the [OK] key.

---

## Disabling of Offset

This setting is used to disable the offset function.

To enable this setting, select the checkbox  and touch the [OK] key.

---

## Disabling of Stapler

**(When a saddle stitch finisher or finisher is installed.)**

This setting is used to prohibit stapling, such as when the stapler unit of the finisher or the saddle stitch finisher malfunctions.

To enable this setting, select the checkbox  and touch the [OK] key.

---

## Saddle Stitch Position Adjust

**(When a saddle stitch finisher is installed.)**

When a saddle stitch finisher is installed, this setting is used to adjust the stapling position (folding position) of the pamphlet staple function.

The value can be adjusted in increments of 0.1 mm within a range of  $\pm 3.0$  mm from the home position of each paper size.

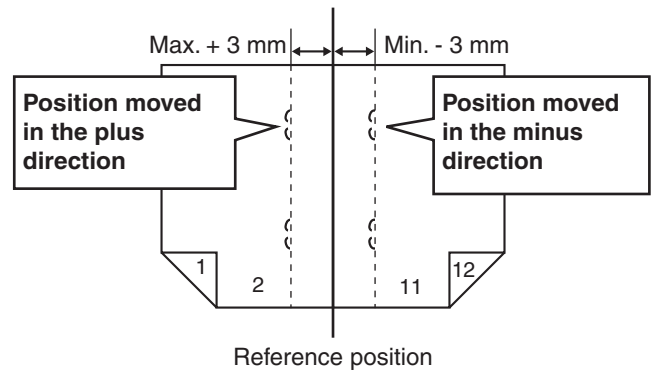

Select the key of the desired paper, specify the value with the   keys, and touch the [OK] key. (To make the number change quickly, keep your finger on the  or  key.)

---

## Disabling of Punch

**(When a punch module is installed.)**

This setting is used to prohibit punching, such as when the punch module of the finisher or the saddle stitch finisher malfunctions.

To enable this setting, select the checkbox  and touch the [OK] key.

---

## Disabling of Color Mode

**(When a color-related problem has occurred.)**

When a color-related problem has occurred and printing is not possible, the use of color mode can be prohibited on an emergency basis and only black and white printing allowed.

To enable this setting, select the checkbox  and touch the [OK] key.



This function is only for use as an emergency measure. Once this setting is enabled, only a service technician can cancel the setting. Promptly contact your dealer or nearest SHARP service department to have a service technician cancel the setting and resolve the color-related problem.

## Auto Paper Selection Setting

The paper types\* that the Auto Paper Selection function will select can be specified. Select one of the following settings:

- Plain Paper
- Plain and Recycle Paper
- Recycle Paper

Select the desired paper type setting and touch the [OK] key.

The Auto Paper Selection function will not select any paper types other than the paper types specified with this setting.

\* The paper type set for each paper tray using "Paper Tray Settings" (page 24) in the system settings (general).

## Registration Adjustment

If the color of text or lines is off when color printing is performed, the colors CMY can be adjusted using K (black) as a reference.

To perform this adjustment, touch the [Auto Adjustment] key. A message will appear. Touch the [Execute] key.



If auto adjustment is not successful, the [Auto Adjustment] key will be temporarily disabled to prevent repeated execution. The next time the registration adjustment screen is opened after moving to another screen, the key will return to normal.

## Optimization of the Hard Disk

This function optimizes the hard drive of the machine by defragmenting data. If a job is in progress, a message will appear and optimization will not begin until the job is finished. During optimization, the following operations are not possible:

- Web page access, reception of print data
- Use of keys on the operation panel
- Turning off the power with the main power switch of the machine.
- Auto Power Shut-Off

When optimization is completed, the machine will automatically restart.



When the document filing function is frequently used and output of files seems somewhat slow, optimizing the hard drive may improve performance.

## Tandem Connection Setting

This setting is used to configure the IP address and port number of the slave machine when you wish to use two machines (which are used as TCP/IP network printers) in a tandem connection for printing.

The screenshot shows a dialog box titled "System Settings" with a sub-title "Tandem Connection Setting" and an "OK" button. It contains three main sections: "IP Address of Slave Machine" with four input boxes containing "0", "0", "0", and "0"; "Port Number" with a single input box containing "50001"; and "Tandem Mode" with two checkboxes: "Disabling of Master Machine Mode" (unchecked) and "Disabling of Slave Machine Mode" (unchecked).

For each entry box, select the box, enter the appropriate value with the numeric keys, and touch the [OK] key.

To disable the sending of tandem printing jobs, select the [Disabling of Master Machine Mode] checkbox  and touch the [OK] key. (Normally this setting is not necessary.)

To disable the reception of tandem printing jobs, select the [Disabling of Slave Machine Mode] checkbox  and touch the [OK] key. (Normally this setting is not necessary.)



- The factory default setting for the port number is [50001]. Unless you experience difficulty with this setting, do not change the port number.
- To use the tandem function when user authentication is enabled, the same user information must be stored on both the master machine and slave machine. If the same user information is not stored, the page count may not be added to the appropriate user count or only the master machine may print.

## Clear All Job Log Data

This is used to clear the entire job log. (There is normally no need to use this function.)

A log file is kept of jobs run on the machine. The job log can be used to check general use of the machine. The job log can be written to a computer in CSV format using a Web browser.

## Detect Standard in Auto Color Mode

When color mode is set to auto in copy mode, five levels are available for the detection of the original. Specify the number with the      keys. When the "Closer to B/W" setting is configured, it makes the original easier to be detected as black and white original. When the "Closer color" setting is configured, it makes the original easier to be detected as a color original.

---



---

# Copy Settings

The following settings are related to copying. Touch the [Copy Settings] key and configure the settings. Default settings selected with these settings apply to all functions of the machine (not just the copy function).

---

## Initial Status Settings

The copier settings are reset when the [POWER] key () is turned on, when the [CLEAR ALL] key () is pressed, or when the auto clear interval has elapsed. These settings are used to change the default settings for copy mode. The following settings can be changed:

- Color Mode
- Paper Tray
- Exposure Type
- Copy Ratio
- 2-Sided Copy
- Output (output method and output tray)

Touch each key and configure the settings.

If you wish to return a changed default setting to the original setting, touch the [Return to the Factory Default Setting] key.





If this setting is used to change the default setting for the duplex function to other than "1-Side to 1-Side" and the duplex function or automatic document feeder fails or is disabled, the setting will revert to "1-Side to 1-Side".

---

## Exposure Adjustment

This is used to adjust the exposure level when "Auto" is used for the copy exposure.

Touch the [Color] key or the [B/W] key, select the exposure level with the   keys for both the document glass and the automatic document feeder, and touch the [OK] key. Lower the level toward "1" for lighter exposure or raise the level toward "9" for darker exposure.

---

## Rotation Copy Setting

When the original and paper are placed in different orientations, this function automatically rotates the image 90 degrees to enable correct copying on the paper.

To enable this setting, select the checkbox  and touch the [OK] key.







- Rotation copy will operate only if Auto Paper Selection or Auto Image has been selected.
- The Rotation Copy setting must be enabled when copying 5-1/2" x 8-1/2" (A5) size original on 5-1/2" x 8-1/2"R (A5R) paper.

---

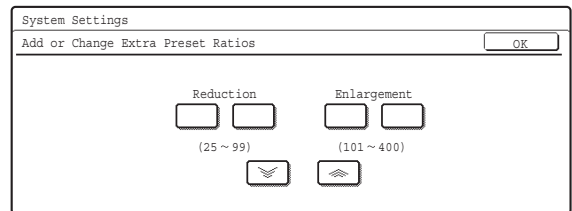
## Add or Change Extra Preset Ratios

Two enlargement preset ratios (101% to 400%) and two reduction preset ratios (25% to 99%) can be added. An added preset ratio can also be changed.



Select the "Reduction" key or the "Enlargement" key, specify the value with the   keys, and touch the [OK] key. (To make the number change quickly, keep your finger on the  or  key.)



Preset ratios other than added preset ratios cannot be changed.





---

## Setting a Maximum Number of Copies

This is used to set the maximum number that can be entered for the number of copies (number of continuous copies). Any number from 1 to 999 can be specified. Enter the number with the numeric keys and touch the [OK] key.





---

## Initial Margin Shift Setting

The default setting for margin shift can be set from 0" (0 mm) to 5/8" (20 mm) in increments of 1/8" (1 mm). Specify the default settings for "Side 1" (front) and "Side 2" (back) with the   keys and touch the [OK] key. (To make the number change quickly, keep your finger on the  or  key.)

---

## Erase Width Adjustment



The default setting for erase width can be set from 0" (0 mm) to 5/8" (20 mm) in increments of 1/8" (1 mm). Specify the default settings for the "Edge" and "Center" with the   keys and touch the [OK] key. (To make the number change quickly, keep your finger on the  or  key.)

---

## Card Shot Settings

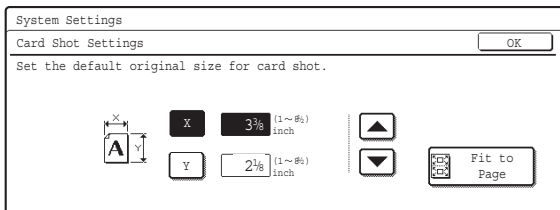
This program is used to set the default original size for the card shot function. Both the X (horizontal) and Y (vertical) dimensions of the original can be set from 1" (25 mm) to 8-1/2" (210 mm) in increments of 1/8" (1 mm).



Select the [X] key or the [Y] key, specify the dimension with the   keys, and touch the [OK] key. If you wish to fit the image to the paper, select the [Fit to Page] key in the card shot settings screen and touch the [OK] key.

---

## Automatic Saddle Stitch





**(When a saddle stitch finisher is installed.)**  
This is used to have saddle stitch stapling take place automatically when the pamphlet copy function is used. To enable this setting, select the checkbox  and touch the [OK] key.

---

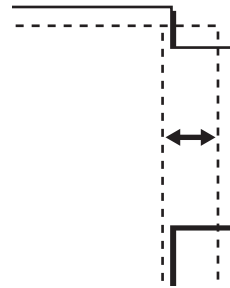
## Initial Tab Copy Setting

This is used to set the default image shift width (tab width) for tab copying. The default width can be set from 0" (0 mm) to 5/8" (20 mm) in increments of 1/8" (1 mm).



Specify the desired number with the   keys and touch the [OK] key. (To make the number change quickly, keep your finger on the  or  key.)

---

## Disabling Deletion of Job Programs

This is used to prohibit the deletion and changing of copy settings stored in job programs. To enable this setting, select the checkbox  and touch the [OK] key.

---

## Disabling of Bypass-Tray in Duplex Copy

This is used to prohibit the use of the bypass tray when making two-sided copies. The bypass tray is often used to feed label sheets, transparency film, and other special papers for which two-sided copying is prohibited. If one of these special papers enters the reversing unit, a misfeed or damage to the unit may result. If special papers for which two-sided copying is prohibited are often used, it is recommended that you enable this setting. To enable this setting, select the checkbox  and touch the [OK] key.

---

## Disabling of Auto Paper Selection

This setting is used to disable the Auto Paper Selection function. When this setting is enabled, automatic selection of paper that is the same size as the original on the document glass or in the automatic document feeder does not take place. To enable this setting, select the checkbox  and touch the [OK] key.

## Auto Selection Setting of Tray that is Supplied the Paper

When this setting is enabled and paper is loaded in a tray while the machine is on standby in copy mode, that tray is automatically selected.

To enable this setting, select the checkbox  and touch the [OK] key.

## Initial Color Balance Setting

Color balance values obtained using "Color Balance" in the special modes can be stored in a program (1 to 48), and those values can be called up and stored as the initial color balance setting.\* Use this feature when you want to repeatedly use a color balance setting for a favorite color or for correction when a change occurs in the color balance.

\* Preset values displayed when you select "Color Balance" in the special modes. The factory default settings are the "0" position for all eight levels of each color.

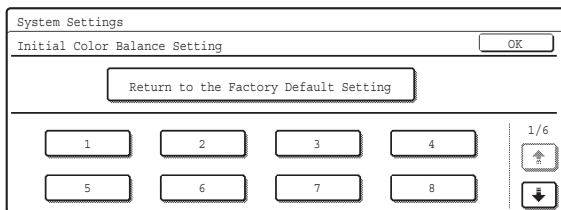

Touch the key of the stored program number and then touch the [OK] key. (A key of a program that has not been stored cannot be selected.)

To return the stored initial color balance setting to the factory default setting (the "0" position for all eight levels of each color), touch the [Return to the Factory Default Setting] key and then touch the [OK] key.

## Auto Color Calibration

This is used to perform automatic color correction when the color in color copies is off. The machine prints a test patch, the test patch is scanned, and the color is automatically corrected.

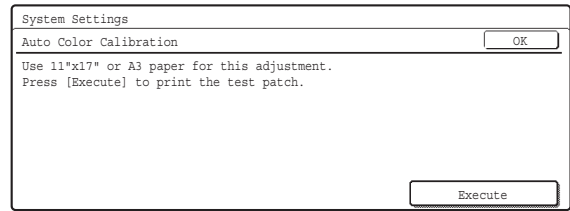

After the [Execute] key is touched and a test patch is printed, a message appears prompting you to begin automatic calibration. Place the test patch on the document glass as shown below so that the narrow line of one-side of the paper is on the left and touch the [Execute] key.

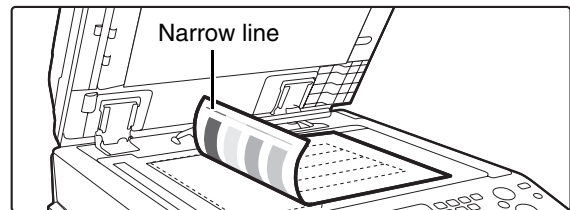

Lay copy paper (about five sheets) that is the same size as the test patch on top of the placed test patch, and gently close the automatic document feeder.



- Before executing Auto Color Calibration, check to see if the registration adjustment is correct. If the registration adjustment is not correct, perform "[Registration Adjustment](#)" (page 95).
- If the color is still off after performing Auto Color Calibration, repeating Auto Color Calibration once again may improve the color.

---

## B/W 600dpi x 600dpi Scanning Mode for Document Feeder

The resolution for copying in black and white using the automatic document feeder can be changed from 600 x 300 dpi to 600 x 600 dpi (high quality mode). When high quality mode is used, fine print and thin lines are reproduced with greater clarity, however, the scanning speed is slower. To enable this setting, select the checkbox  and touch the [OK] key.



When high quality mode is not selected, the following conditions must be satisfied in order to scan at 600 x 300 dpi and attain the fastest speed.

- The copy ratio must be set to 100%.
- Do not select a special mode that will change the ratio.
- [Copy of Copy] must not be enabled.
- Do not copy in black and white with the [COLOR START] key (○●●●).

---

## B/W Quick Scan from Document Glass

The resolution for copying in black and white using the document glass can be changed from 600 x 600 dpi to 600 x 300 dpi (high speed mode). When high speed mode is selected, the first copy time is quicker but the copy image is not as clear. To enable this setting, select the checkbox  and touch the [OK] key.



When high speed mode is selected, the following conditions must be satisfied in order to scan at 600 x 300 dpi and attain the fastest speed.



- The copy ratio must be set to 100%.
- Do not select a special mode that will change the ratio.
- [Copy of Copy] must not be enabled.
- Do not copy in black and white with the [COLOR START] key (○●●●).

---

---

# Network Settings

Network settings are described below. Touch the [Network Settings] key and configure the settings.

 When any of these settings are changed, you must exit the system settings, turn off the [POWER] key (  ), wait a brief interval, and then turn the [POWER] key (  ) back on to make the new settings take effect.

---

## IP Address Setting

When using the machine on a TCP/IP network, use this setting to configure the IP address of the machine.

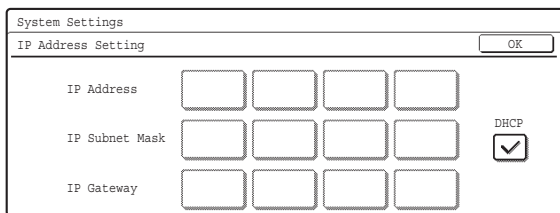

Make sure that the [DHCP] checkbox is not selected  and then select each key, enter the required values with the numeric keys, and touch the [OK] key.

To set the machine to obtain an IP address automatically, select the [DHCP] checkbox  and touch the [OK] key.



- To use the machine on a TCP/IP network, the "Enable TCP/IP" setting must also be enabled.
- If DHCP is used, the IP address assigned to the machine may change automatically. If the IP address changes, printing will not be possible.

---

## Enable TCP/IP

To use the machine on a TCP/IP network, this setting must be enabled. The IP address of the machine must also be configured using "IP Address Setting".

To enable this setting, select the checkbox  and touch the [OK] key.

---

## Enable NetWare

To use the machine on a NetWare network, this setting must be enabled.

To enable this setting, select the checkbox  and touch the [OK] key.

---

## Enable EtherTalk

To use the machine on an EtherTalk network, this setting must be enabled.

To enable this setting, select the checkbox  and touch the [OK] key.

---

## Enable NetBEUI

To use the machine on a NetBEUI network, this setting must be enabled.

To enable this setting, select the checkbox  and touch the [OK] key.

---

## Reset the NIC

This returns all of the settings on the print server card to the factory default settings.

---

## Ping Command

Use this function to check if the machine can communicate with a computer on the network. Specify the IP address of the desired computer and touch the [Start] key. A message will appear indicating whether or not the computer responded.

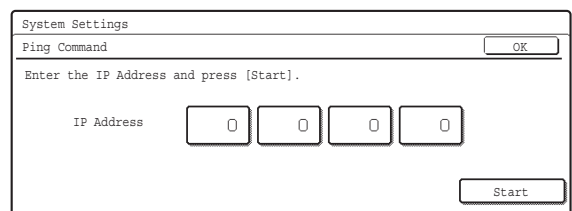

Select each key, enter the appropriate values with the numeric keys, and touch the [Start] key.

---

---

# Printer Settings

## Default Settings

Printer condition settings are described below.

Touch the [Printer Settings] key, touch the [Default Settings] key, and configure the settings.

---

### Prohibit Notice Page Printing

This setting is used to disable printing of notice pages.

To enable this setting, select the checkbox  and touch the [OK] key.

---

### Prohibit Test Page Printing

This setting is used to disable printing of test pages.

When this setting is enabled, "Printer Test Page" in the system settings cannot be used to print test pages.

To enable this setting, select the checkbox  and touch the [OK] key.

---

### A4/Letter Size Auto Change

When printing an A4 size image, this setting allows letter size paper to be used if A4 size paper is not loaded.

To enable this setting, select the checkbox  and touch the [OK] key.

---

### Print Density Level

This lightens or darkens the print density of color and black and white images. The print density can be adjusted to five levels.

Use the      keys to adjust the density level for "Color" and "B/W", and touch the [OK] key.

Lower the level toward "1" for lighter exposure or raise the level toward "5" for darker exposure.

---

### Bypass Tray Settings

#### Enable Detected Paper Size in Bypass Tray

This is used to prohibit printing when the paper size specified for a print job is different from the paper size inserted in the bypass tray.

To enable this setting, select the checkbox  and touch the [OK] key.

#### Enable Selected Paper Type in Bypass Tray

This is used to prohibit printing when the paper type specified for a print job is different from the paper type inserted in the bypass tray.

To enable this setting, select the checkbox  and touch the [OK] key.

#### Exclude Bypass-Tray from Auto Paper Select

When [Auto] is selected for paper type selection, the bypass tray can be excluded from the trays that can be selected. This is recommended when special paper is often placed in the bypass tray.

To enable this setting, select the checkbox  and touch the [OK] key.

---

### Job Spool Queuing

When this function is enabled, received print jobs are displayed in the spool queue of the job status screen.

The jobs are moved to the job queue after they have been analyzed by the machine. Multiple jobs that have not yet been analyzed can appear in the spool queue.

When this function is disabled, received print jobs are displayed in the job queue without being displayed in the spool queue. However, when an encrypted PDF job is printed, the job appears in the spool queue.

To enable this setting, select the checkbox  and touch the [OK] key.





---

## Port Switching Method

This setting is used to select when port switching takes place.

- Switch at End of Job:  
The port changes to auto selection when printing ends.
- Switch after I/O Timeout:  
When the time set in "[I/O Timeout](#)" (page 102) elapses, the port changes to auto selection.

Select one of the keys and touch the [OK] key.



The following two print ports are available on the machine:

- USB port
- Network port

---

## Color Adjustments

This is used to adjust grayscale and color balance.

Touch [Printer Settings] key and touch the [Color Adjustments] key and configure the settings.

---

## Auto Color Calibration

This is used to perform automatic color correction when the color in color copies is off. The machine prints a test patch, the test patch is scanned, and the color is automatically corrected.

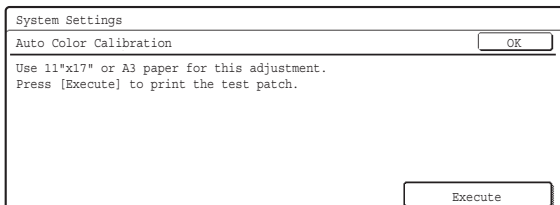

After the [Execute] key is touched and a test patch is printed, a message appears prompting you to begin automatic calibration. Place the test patch on the document glass as shown below so that the narrow line of one-side of the paper is on the left and touch the [Execute] key.

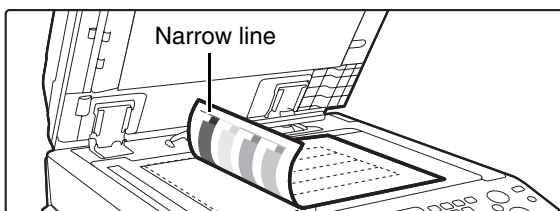

Lay copy paper (about five sheets) that is the same size as the test patch on top of the placed test patch, and gently close the automatic document feeder.



- Before executing Auto Color Calibration, check to see if the registration adjustment is correct. If the registration adjustment is not correct, perform "[Registration Adjustment](#)" (page 95).
- If the color is still off after performing Auto Color Calibration, repeating Auto Color Calibration once again may improve the color.

---

---

# Image Send Settings

Scan, Internet fax, and fax settings are described below.



Settings for fax are explained in "11. SYSTEM SETTINGS FOR FAX" in the Facsimile Guide.

---

## Operation Settings

Scan, Internet fax, and fax settings are described below.

Touch the [Image Send Settings] key, touch the [Operation Settings] key, and configure the settings.

---

### Default Display Setting

Five screen selections are available for the base screen that appears when you press the [IMAGE SEND] key, or when you press the [CLEAR ALL] key (CA) in image send mode.

- Scanner
- Internet Fax
- Fax
- Address Book (ABC)
- Address Book (Group)

When [Switch Automatically to Copy Mode Screen] is selected , the display will automatically switch to the copy mode screen if no action is taken in the image send mode screen for 20 seconds.

When the [Hold settings for a while after scanning has been completed] checkbox is selected , the settings will remain in effect a fixed period of time after scanning is completed.

---

### Initial Resolution Setting

The following settings are available for the default resolutions of scan, Internet fax, and fax mode.

- Scanner: 100X100dpi  
200X200dpi  
300X300dpi  
400X400dpi  
600X600dpi
  - Internet Fax: 200X100dpi  
200X200dpi  
200X400dpi  
400X400dpi  
600X600dpi
  - Fax: Standard  
Fine  
Super Fine  
Ultra Fine
- Half Tone

When using a stored image file, select the [Apply the Resolution Set when Stored] checkbox  and touch the [OK] key to use the resolution set when the file was stored.

---

### Default Exposure Settings

This setting is used to set the default exposure level for scanning originals in image send mode.

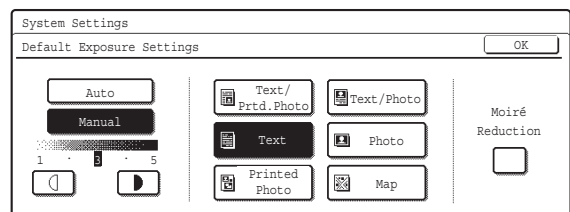

#### • Exposure

The exposure can be adjusted automatically or manually. Select either the [Auto] key or the [Manual] key. If the [Manual] key is selected, specify the exposure with the   keys and touch the [OK] key. Lower the level toward "1" for lighter exposure or raise the level toward "5" for darker exposure.

#### • Original Image Type (Configuring the setting is only possible in scanner mode.)

The exposure mode can be selected to match the original type. Select the desired key and touch the [OK] key.

- Text/Prt'd. Photo
- Text/Photo
- Text
- Photo\*
- Printed Photo\*
- Map\*

\* Does not appear when the exposure is set to [Auto].

#### • Moiré Reduction (Configuring the setting is only possible in scanner mode.)

To reduce the moire effect when scanning, select the [Moiré Reduction] checkbox  and touch the [OK] key.

---

## Must Input Next Address Key at Broadcast Setting

This setting is used to require that the [Next Address] key be touched before the next address is entered when performing a broadcast transmission.

When this setting is enabled, the [Next Address] key cannot be omitted even if the next address is entered with a one-touch key.

If a user attempts to enter the next address without touching the [Next Address] key, a double-beep alarm will sound and the entry will be rejected.

To enable this setting, select the checkbox  and touch the [OK] key.

---

## Scan Complete Sound Setting

The scan complete sound can be selected.

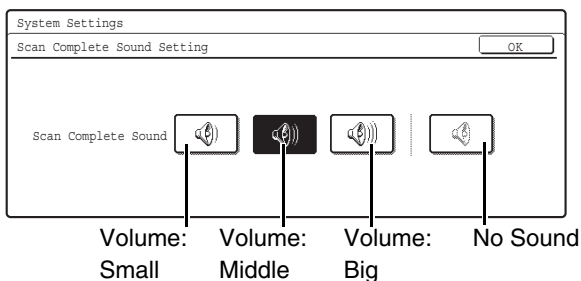

Select one of the keys and touch the [OK] key.

---

## The Number of File Name/Subject/Body Keys Displayed Setting

This setting is used to select the number of file name / subject keys that are displayed in the screen. The number of keys can be set to 3 or 6.

Select one of the keys and touch the [OK] key.

---

## The Number of Direct Address Keys Displayed Setting

This setting is used to select the number of one-touch keys that are displayed in the Address Book screen. The number of keys can be set to 6 or 9.

Select one of the keys and touch the [OK] key.

---

## Disable Switching of Display Order

This is used to prohibit changes to the order of display (order search number, ascending, descending) in the Address Book.

When this setting is enabled, touching a tab in the Address Book screen does not change the order. The currently selected display order will be the order that is used after the setting is selected.

To enable this setting, select the checkbox  and touch the [OK] key.

---

## Hold Setting for Received Data Print

This function holds received faxes and Internet faxes in memory without printing them. The faxes can be printed by entering a password (factory default setting: 0000) with the numeric keys.

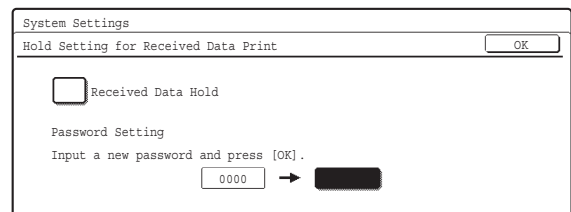

To enable this setting, select the [Received Data Hold] checkbox , enter a password with the numeric keys when you wish to change the password, and touch the [OK] key.

---

## Settings to Disable the Registration of Destination

This is used to prohibit the storing of destinations. Storing from the machine, storing from the Web page, and storing from a computer can each be separately prohibited.

### Disable Registering Destination from Operation Panel

Disables address control from the machine. To use this setting, select the desired items  and touch the [OK] key.

- Group
- E-mail
- Internet Fax
- Fax

(When the [Select/Cancel All] key is touched, all settings become . When the key is touched in the checked condition, all settings become .)

### Disable Registering Destination on Web Page

**(When network connection is enabled.)**  
Disable address control from the Web page. To use this setting, select the checkboxes  of the desired items from the following and touch the [OK] key.

- Group
- E-mail
- FTP
- Desktop
- Network Folder
- Internet Fax
- Fax

(When the [Select/Cancel All] key is touched, all settings become . When the key is touched in the checked condition, all settings become .)

### Disable Registration Using Network Scan Tools

**(When network connection is enabled.)**  
Disable address control from the Network Scanner Tool. To enable this setting, select the checkbox  and touch the [OK] key.

---

## Settings to Disable Transmission

These settings are used to disable the following transmission operations.

### Disable [Resend] on Fax/Image Send Mode

Disable the use of the [Resend] key on the basic screen of image send mode.

To enable this setting, select the checkbox  and touch the [OK] key.

### Disable Selection from the Address Book

This is used to disable selecting the destination from the Address Book.

To use this setting, select the checkboxes  of the desired items from the following and touch the [OK] key.

- E-mail
- FTP
- Desktop
- Network Folder
- Internet Fax
- Fax

(When the [Select/Cancel All] key is touched, all settings become . When the key is touched in the checked condition, all settings become .)

### Disable Direct Entry

This prohibits the direct entry of the address. To use this setting, select the checkboxes  of the desired items from the following and touch the [OK] key.

- E-mail
- Internet Fax
- Fax

(When the [Select/Cancel All] key is touched, all settings become . When the key is touched in the checked condition, all settings become .)

### Disable PC-I-Fax Transmission

**(When Internet fax expansion kit is installed.)**

Disable transmission from PC-I-Fax.

To enable this setting, select the checkbox  and touch the [OK] key.

### Disable PC-Fax Transmission

**(When the facsimile expansion kit is installed.)**

Disable transmission from PC-Fax.

To enable this setting, select the checkbox  and touch the [OK] key.

# Scan Settings

The following settings are related to scanning.

Touch the [Image Send Settings] key, touch the [Scan Settings] key, and configure the settings.

## Default Sender Set

If a sender is not selected when a Scan to E-mail transmission is performed, the sender information stored in this setting is automatically used.

### 1 Touch the [Sender Name] key and enter the sender name.

Up to 20 characters can be entered for the name. After you have entered the name, touch the [OK] key.

### 2 Touch the [Re.Address] key and enter the return address.

A maximum of 64 characters can be entered. After you have entered the address/domain, touch the [OK] key.

### 3 Touch the [OK] key.



For the procedure for entering text, see "6. ENTERING TEXT" in the User's Guide.

## Default Color Mode Settings

This is used to set the default color mode settings for Black & White and Color in scan mode.

- Color Mode: Auto (Mono2, Grayscale\*), Full Color
- B/W Mode: Mono 2, Grayscale

Touch the "Color" key or the "B/W" key as appropriate, select the setting, and touch the [OK] key.

If disabling black and white setting from the basic screen when the color mode is set to "Auto", select the "Disable Change of B/W Setting in Auto Mode" checkbox  and touch the [OK] key.

\* When scanning black and white original on the color mode "Auto".

## Initial File Format Setting

This is used to set the default file format for Scan to E-mail and USB memory mode when the e-mail address is entered manually by touching the [Address Entry] key.

### Screen when Black & White is selected

#### • File Type

B/W: PDF, Encrypt PDF, TIFF

Color/Gray: PDF, Encrypt PDF, TIFF, JPEG

#### • Compression Mode

B/W: None, MH(G3), MMR(G4)

Color/Gray: Low, Medium, High

Select the desired keys. When finished, touch the [OK] key.

To change the number of pages per file, select the [Specified Pages per File] checkbox , specify the number of pages with the   keys, and touch the [OK] key. (To make the number change quickly, keep your finger on the  or  key.)



When [JPEG] is selected for the file type, [Specified Pages per File] cannot be selected.

## Compression Mode at Broadcasting

This is used to set the compression mode for broadcasting using Scan to E-mail or Internet fax. The compression mode set here is used for all destinations regardless of their individual compression mode settings.

Black & White: MH(G3), MMR(G4)

Color/Grayscale: Low, Medium, High

Touch the "Color/Grayscale" key or the "Black & White" key as appropriate, select the setting, and touch the [OK] key.

---

## Maximum Size of E-mail Attachments (E-mail)

To prevent the transmission of excessively large image files in scan mode, a file size limit can be set from 1 MB to 10 MB in increments of 1 MB.

If the size of the image file created by scanning the original exceeds the limit, the image file is discarded.

To set a limit, make sure that the [Unlimited] key is not selected , specify the limit with the    keys, and touch the [OK] key. (To make the number change quickly, keep your finger on the  or  key.)

If you do not want to set a limit, select the [Unlimited] key  and touch the [OK] key.



This setting is linked to "[Maximum Size of E-mail Attachments \(E-mail\)](#)" (page 111) in the Internet Fax Send Settings.

---

## Maximum Size of Data Attachments (FTP/Desktop/Network Folder)

A limit can be set for the size of files that can be sent by Scan to FTP, Scan to Desktop, and Scan to Network Folder.

To enable this setting, select the checkbox  and touch the [OK] key.



- For the configured file size limit, consult your dealer.
- When a broadcast transmission is performed that includes both e-mail and Internet fax destinations, the limit set in "[Maximum Size of E-mail Attachments \(E-mail\)](#)" takes priority.

---

## Default Address Setting

A default address can be stored that makes it possible to transmit by simply pressing the [COLOR START] key (○●●●●) or the [BLACK & WHITE START] key (○●●) without specifying an address.

System Settings  
Default Address Setting Cancel OK

Enable Default Address

Add Selected

- 1 Select the [Enable Default Address] checkbox .

- 2 Touch the [Add Selected] key and select the address.

Select one of the keys and touch the [OK] key.

- 3 Touch the [OK] key.



- When this setting is enabled, the base screen changes to scan mode.
- Transmission is only possible to a single Scan to E-mail, Scan to FTP, Scan to Desktop, or Scan to Network Folder address.

---

## Bcc Setting

This setting enables BCC delivery.

When the [Enable Bcc] checkbox is selected , the [Bcc] key appears in the image send address book screen with the [To] and [Cc] keys.

When the [Display Bcc Address on the Job Status Screen] checkbox is selected , BCC addresses appear in the job status screen list and Address Review tab.

---

## Disable Scan Function

This is used to disable PC scan and USB memory scan. When these modes are disabled, they are grayed out when the mode is being selected.

Select the checkboxes  of the modes that you wish to disable and touch the [OK] key.

---

## Pre-Setting Mail Signature

A signature can be automatically appended to the end of the body text of e-mail. This is convenient when it is a corporate policy to append a certain signature at the end of e-mail.

The signature to be appended is configured in the Web pages. This setting simply enables or disables the signature.

To enable this setting, select the checkbox  and touch the [OK] key.



This setting is linked to "[Pre-Setting Mail Signature](#)" (page 110) in the I-Fax Default Settings.

# I-Fax Settings



These settings can be configured when the Internet fax expansion kit is installed.

## I-Fax Default Settings

These settings are used to configure the default settings for Internet fax.

Touch the [Image Send Settings] key, the [I-Fax Settings] key, and the [I-Fax Default Settings] key, and configure the settings.

## I-Fax Own Name and Address Set

This is used to configure the sender name and address for Internet fax. The entered sender name and address are printed at the top of each fax page you send.

System Settings  
I-Fax Own Name and Address Set

Name AAA AAA

Own Address aaa@aaa.aa.com

OK

### 1 Touch the [Name] key and enter the name.

A maximum of 40 characters can be entered for the name. After you have entered the name, touch the [OK] key.

### 2 Touch the [Own Address] key and enter the sender address.

A maximum of 56 characters can be entered. After you have entered the address/domain, touch the [OK] key.

### 3 Touch the [OK] key.



For the procedure for entering text, see "6. ENTERING TEXT" in the User's Guide.

## Auto Wake Up Print

When the [POWER] key () is "off" (but the main power switch is "on") and an Internet fax is received, this function activates the machine and prints the fax.

To enable this setting, select the checkbox  and touch the [OK] key.

When this function is disabled, received Internet faxes are not printed until the [POWER] key () is switched "on".

## I-Fax Speaker Volume Settings

This is used to adjust the volume of fax receive signals and communication error signals heard through the speaker.

A fax receive signal sounds after the machine checks the mail server and retrieves received faxes. A communication error signal sounds when a delivery failed e-mail is received from the destination Internet fax machine.

System Settings  
I-Fax Speaker Volume Settings

Receive Signal

Communication Error Signal

OK

Volume: Small    Volume: Middle    Volume: Big    No Sound

Select one of the keys and touch the [OK] key.

## Original Print on Transaction Report

When a transaction report is printed, this is used to print part of the first page of the transmitted original on the transaction report. Select one of the settings below.

- Print Out All Report
- Print Out Error Report Only
- No Printed Report

Select one of the keys and touch the [OK] key.

This setting will not be effective if the following "[Transaction Report Print Select Setting](#)" (page 110) is set to "No Printed Report".



---

## Transaction Report Print Select Setting

This is used to select whether or not a transaction report will be printed, and if printed, the condition for being printed. Select a setting for each of the following operations:

### Single Sending

- **Print Out All Report:**  
Print a report after each transmission.
- **Print Out Error Report Only:**  
Print a report when transmission fails.
- **No Printed Report:**  
Never print a report.

### Broadcasting

- **Print Out All Report:**  
Print a report after each broadcast transmission.
- **Print Out Error Report Only:**  
Print a report when transmission fails.
- **No Printed Report:**  
Never print a report.

### Receiving

- **Print Out All Report:**  
Print a report after each reception.
- **Print Out Error Report Only:**  
Print a report when a reception error occurs.
- **No Printed Report:**  
Never print a report.

Select the desired key in each setting screen and touch the [OK] key.

When a transaction report is printed, you can have part of the first page of the transmitted original printed on the transaction report. For more information, see "[Original Print on Transaction Report](#)" (page 109).

---

## Activity Report Print Select Setting

This is used to have the Image Sending Activity Report stored in the machine's memory print at specified times. When [Auto Print at Memory Full] is selected , the activity report will automatically print when a combined total of 200 transmissions and receptions is reached. When [Print Daily at Designated Time] is selected , the activity report will automatically print at the specified time each day. (Both settings can be selected simultaneously.)

To enable either or both settings, select either or both checkboxes . If [Print Daily at Designated Time] is selected , keys will appear for you to specify the time. Touch the "Hour" and "Minute" keys, set values for each with the   keys, and touch the [OK] key when finished. (To make the number change quickly, keep your finger on the  or  key.)



- If you only select the "Print Daily at Designated Time" setting  and the number of recorded transactions exceeds 200 before the specified time, each new transaction will delete the oldest transaction (the oldest transaction will not be printed).
- The Image Sending Activity Report can also be printed manually. See "[List Print \(Administrator\)](#)" (page 116) in the system settings (administrator).

---

## Body Text Print Select Setting

Image files attached to Internet faxes are normally printed. This setting can be enabled to also have the e-mail body text (subject and message) printed. This setting also applies to printing of the body text of e-mail messages without file attachments. To enable this setting, select the checkbox  and touch the [OK] key.



A maximum of 5 pages of body text can be printed.

---

## Pre-Setting Mail Signature

A signature can be automatically appended to the end of the body text of e-mail. This is convenient when it is a corporate policy to append a certain signature at the end of e-mail.

The content of the signature is configured in the Web pages. This setting simply enables or disables the signature.

To enable this setting, select the checkbox  and touch the [OK] key.



This setting is linked to "[Pre-Setting Mail Signature](#)" (page 108) in the Scan Settings.

## I-Fax Send Settings

I-Fax Send Settings are described below.

Touch the [Image Send Settings] key, the [I-Fax Settings] key, and the [I-Fax Send Settings] key, and configure the settings.

---

### I-Fax Reception Report On/Off Setting

This setting is used to request a reception report when an Internet fax is sent.

The reception report is returned to the sender address stored in "Set I-Fax Own Name and Address".

To enable this setting, select the checkbox  and touch the [OK] key.

---

### I-Fax Reception Report Request Timeout Setting

The duration of time that the machine will wait for a reception report from the destination machine can be set by any number from 1 minute to 240 hours.

Select the "Hour" key and "Minute" key, specify the values with the   keys, and touch the [OK] key. (To make the number change quickly, keep your finger on the  or  key.)

 This setting can only be configured when "I-Fax Reception Report On/Off Setting" is enabled.

---

### Number of Resend Times at Reception Error

When an error message is received from an Internet fax destination, the number to resend can be set from 0 to 15.

Specify the desired number with the   keys and touch the [OK] key. (To make the number change quickly, keep your finger on the  or  key.)

 This setting can only be configured when "I-Fax Reception Report On/Off Setting" is enabled.

---

### Maximum Size of E-mail Attachments (E-mail)

To prevent the transmission of excessively large image files by Internet fax, a file size limit can be set from 1 MB to 10 MB in increments of 1 MB.

If the size of the image file created by scanning the original exceeds the limit, the image file is discarded. To set a limit, make sure that the [Unlimited] key is not selected , specify the limit with the   keys, and touch the [OK] key. (To make the number change quickly, keep your finger on the  or  key.)

If you do not want to set a limit, select the [Unlimited] key  and touch the [OK] key.

 This setting is linked to "[Maximum Size of E-mail Attachments \(E-mail\)](#)" (page 108) in the Scan Settings.

---

### Rotation Sending Setting

When transmitting an image that is one of the following sizes, this function rotates the image counterclockwise 90 degrees.

- 8-1/2" x 11", 5-1/2" x 8-1/2"R, A4, B5R, A5R, 16K

To use this setting, select the checkboxes  of the desired sizes and touch the [OK] key.

 8-1/2"x11"R and A4R size images are not rotated.

---

### Printing Page Number at Receiver

When the transmitted image is printed by the receiving machine, the page number can be added to the top of each printed page.

To enable this setting, select the checkbox  and touch the [OK] key.

## I-Fax Receive Settings

I-Fax Receive Settings are described below.

Touch the [Image Send Settings] key, the [I-Fax Settings] key, and touch the [I-Fax Receive Settings] key, and configure the settings.

---

### Auto Receive Reduce Setting

When a fax is received that includes the sender's name and number, the received image is slightly larger than the standard size. This setting is used to automatically reduce the image to fit the standard size.

To enable this setting, select the checkbox  and touch the [OK] key.



- If Auto Receive Reduce is disabled, the edges of the image outside the standard size will be cut off. However, the image will be clearer because it will be printed at the same size as the original.
- Standard sizes are sizes such as 8-1/2" x 11" and 8-1/2" x 5-1/2" (A4 and B5).

---

### Duplex Reception Setting

This is used to select whether received faxes are printed on both sides of the paper.

When this setting is enabled and a fax consisting of 2 or more pages is received (the pages must be the same size), the pages are printed on both sides of the paper.

To enable this setting, select the checkbox  and touch the [OK] key.

---

### Set Address for Data Forwarding

When the machine is unable to print a received fax, the fax can be forwarded to another machine. This setting is used to configure the address of the other machine.

System Settings  
Set Address for Data Forwarding [OK]

Forwarding to yyy@xx.xxx.com

#### 1 Touch the [Forwarding to] key and enter the forwarding address.

A maximum of 64 characters can be entered for the address. After you have entered the address, touch the [OK] key.

#### 2 Touch the [OK] key.



- For the procedure for entering text, see "6. ENTERING TEXT" in the User's Guide.
- Multiple forwarding addresses cannot be stored.

---

### A3 RX Reduce

When a A3 size fax is received, this function reduces the fax to letter size.

To enable this setting, select the checkbox  and touch the [OK] key.



When this setting is enabled, W letter size faxes are also reduced.

---

### POP3 Communication Timeout Setting

The duration of time the machine waits until stopping reception when a response is not received from the mail server (POP3 server) can be set from 30 to 300 seconds in increments of 30 seconds.

Specify the time with the   keys and touch the [OK] key. (To make the number change quickly, keep your finger on the  or  key.)

---

### Reception Check Interval Setting

This is used to specify the interval at which the machine automatically checks the mail server (POP3 server) for received Internet faxes. The interval can be set from 0 minutes to 8 hours in increments of 1 minute.

When 0 hours 0 minutes is specified, the machine does not automatically check the mail server for received Internet faxes.

Select the "Hour" key and "Minute" key, specify the values with the   keys, and touch the [OK] key. (To make the number change quickly, keep your finger on the  or  key.)



The machine also checks the mail server (POP3) for received Internet faxes when it is powered on. (Except when 0 hours 0 minutes is specified.)

## Anti Junk Mail/Domain Name Setting

This setting is used to allow or refuse reception from specified addresses/domains.

To refuse reception from specified addresses/domains, select the [Reject Reception] key and touch the [OK] key.

When permitting only reception from the address or the domain that you program, touch the [Allow Reception] key and then the [OK] key.

To allow reception from all addresses/domains even when there are addresses/domains specified, select [All Invalid].

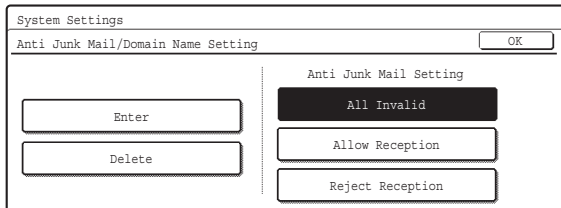

## Storing addresses/domains

Up to 50 addresses/domains can be stored.

### 1 Touch the [Enter] key and enter the address or domain.

A maximum of 64 characters can be entered. After you have entered the address/domain, touch the [OK] key.

### 2 Touch the [OK] key.

To store another address/domain, repeat the procedure from step 1. Addresses/domains will be stored in succession.



- For the procedure for entering text, see "6. ENTERING TEXT" in the User's Guide.
- When there are no stored anti junk mail addresses, only the [Enter] key can be selected.
- If the first character of the entry is not "@", the entry is identified as an address. If the first character is "@", the entry is identified as a domain. (xxx@xx.xxx.com is treated as an address, and @xx.xxx.com is treated as a domain.)
- Storing an address specifies only that address. Storing a domain specifies all addresses that include that domain.

## Deleting

### 1 Touch the [Delete] key.

Touch the address or domain that you wish to delete in the list of stored addresses/domains. A confirmation message will appear. Touch the [Yes] key.

### 2 Touch the [OK] key.

## I-Fax Output Setting

(When a right tray is installed.)

Set the output tray when Internet fax is received.

Select the desired key (the keys will vary depending on the machine configuration) and touch the [OK] key.

---

---

# Document Filing Settings

Document filing settings are described below. Touch the [Document Filing Settings] key and configure the settings.

---

## Default Mode Settings

This is used to specify which mode, Sharing or Confidential, is used as the default mode when storing a file.

When [Confidential Mode] is selected, the [Confidential] checkbox in the file information screen will be selected .

Select one of the keys and touch the [OK] key.

---

## Sort Method Setting

This setting is used to select the order of display of files stored in the Main Folder, Custom Folder, and Quick File Folder. Select one of the following settings:

- File Name
- User Name
- Date

Select one of the keys and touch the [OK] key.

### Example of folder screen

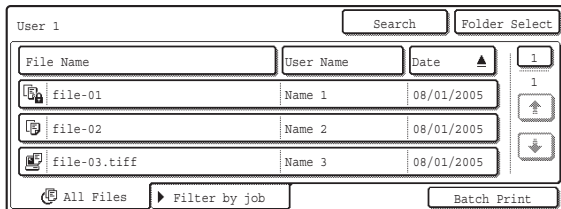

---

## Document Output Options

This is used to select which types of stored jobs are allowed to be called up and used.

The items that appear will vary depending the machine configuration.

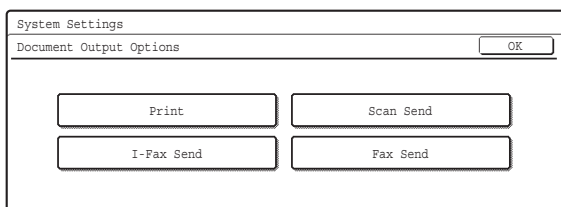

Touch the key that you wish to configure.

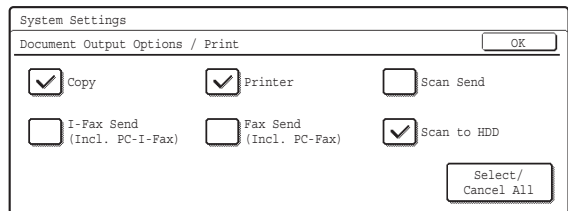

Select the checkboxes  of the desired jobs and touch the [OK] key.

(When the [Select/Cancel All] key is touched, all settings become . When the key is touched in the checked condition, all settings become .)

---

## Administrator Authority Setting

For files and custom folders that have a password, this setting is used to allow an administrator password to be entered to cancel and delete the password.

Select the desired checkboxes  and touch the [OK] key.



This setting can only be used to delete a password. It cannot be used to change a password.

---

## Default Color Mode Settings

Sets to the standard settings for Scan to HDD.

- Color: Auto, Full Color, 2 Color
- B/W: Mono 2, Grayscale

Touch the "Color" key or the "B/W" key as appropriate, select the setting, and touch the [OK] key.

---

## Default Exposure Settings

This setting is used to adjust the exposure level for scanning in document filing mode.

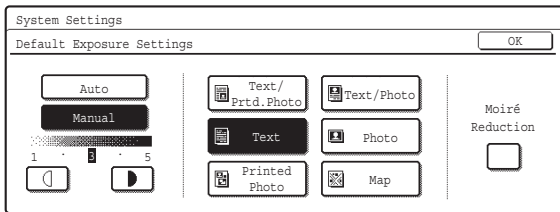

### • Exposure

The exposure can be adjusted automatically or manually. Select either the [Auto] key or the [Manual] key. If you selected [Manual], specify the exposure with the keys. Lower the level toward "1" for lighter exposure or raise the level toward "5" for darker exposure.

### • Original Image Type

The exposure mode can be selected to match the original type. Select the desired key.

- Text/Prt'd. Photo
- Text/Photo
- Text
- Photo\*
- Printed Photo\*
- Map\*

\* Does not appear when the exposure is set to [Auto].

### • Moiré Reduction

To reduce the moiré effect when scanning, select the [Moiré Reduction] checkbox .

---

## Initial Resolution Setting

The transmission resolution can be set to one of the following resolutions.

- 100X100dpi
- 200X200dpi
- 300X300dpi
- 400X400dpi
- 600X600dpi

Select one of the keys and touch the [OK] key.

---

## Color Data Compression Ratio Setting

[Low], [Medium], or [High] can be selected for the compression ratio for transmission of a stored color file. Select one of the keys and touch the [OK] key.

---

## Default Output Tray

(When a right tray is installed.)

This setting is used to select the default output tray for printing a file stored by Scan to HDD.

The items that appear will vary depending the machine configuration.

Select one of the keys and touch the [OK] key.

---

## Scan Complete Sound Setting

This setting adjusts the volume of the beep that sounds when scanning ends. The beep can also be turned off.

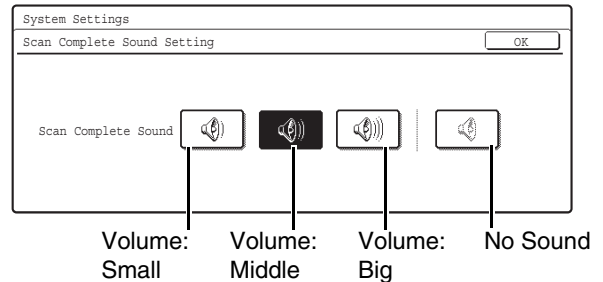

Select one of the keys and touch the [OK] key.

---

## Delete All Quick Files

This function deletes all files except protected files from the Quick File Folder.

To delete all files, touch the [Delete] key.

To have all files except protected files automatically deleted from the Quick File Folder when the [POWER] key () is switched "on", select the [Delete quick files at power up. (Protected files excluded)] checkbox .

---

## Disable Stamp for Reprinting

When a stored file is called up and printed, this setting prohibits the selection of a "Stamp" setting in the special modes. If a stamp setting is already selected, it will not be possible to change the stamp setting.

This function can be used to prevent inconsistencies in the printed information, such as that of the original date in the file and the date the file is called up and printed.

To enable this setting, select the checkbox  and touch the [OK] key.

---

## Batch Print Settings

When printing files by batch printing, this setting is used to prohibit the selection of the [All Users] key and the [User Unknown] key in the user selection screen.

Select the checkboxes  of the items below that you wish to prohibit and touch the [OK] key.

- Selection of [All Users] is not allowed.
- Selection of [User Unknown] is not allowed.

---

---

# List Print (Administrator)

This is used to print lists and reports that are only for use by the administrator of the machine. Touch the [List Print (Administrator)] key and configure the settings.

---

## Administrator Settings List

Lists of the administrator settings for the following modes can be printed.

- Copy
- Print
- Image Send
- Document Filing
- Security
- Common
- All Administrator Settings List

Touch the desired key. Printing will begin.

---

## Image Sending Activity Report

The following Image Sending Activity Reports can each be separately printed.

- Image Sending Activity Report (Scanner)
- Image Sending Activity Report (Internet Fax)
- Image Sending Activity Report (Fax)

Touch the desired key. Printing will begin.

---

## Anti Junk Fax Number List

**(When the facsimile expansion kit is installed.)**

This prints a list of the Anti Junk fax numbers stored using "Anti Junk Fax Setting" in the system settings (administrator).



For more information, see "11. System Settings for Fax" in the Facsimile Guide.

---

## Anti Junk Mail/Domain Name List

**(When the Internet Fax expansion kit is installed.)**

This prints a list of the anti junk addresses/domain names that have been stored using "[Anti Junk Mail/Domain Name Setting](#)" (page 113) in the system settings (administrator).

---

## Inbound Routing List

This prints a list of the "Inbound Routing Settings".

---

## Document Admin List

This prints a list of the "Document Administration Function" settings.

---

## Web Setting List

**(When network connection is enabled.)**

This prints a list of the settings that are configured in the Web pages.

---

## Metadata Set List

**(When the application integration module is installed.)**

This prints a list of the metadata set stored in the Web pages.

---

---

# Security Settings

The following settings are related to security. Touch the [Security Settings] key and configure the settings.

---

## SSL Settings

SSL transmission can be applied to a data transmission on the network.

SSL is the protocol enable to encrypt the data and receive and send it. Encrypting data makes it possible to transmit and receive sensitive information safely.

SSL can be enabled for the following protocols:

- HTTPS: Use SSL encryption for the exchange of information between a Web server and clients.
- IPP-SSL: Use SSL encryption for transmission and reception using IPP.

To enable these settings, select the desired checkboxes

and touch the [OK] key.



---

---

# Enable/Disable Settings

The following settings are used to prohibit the use of certain functions. Touch the [Enable/Disable Settings] key and configure the settings.



The Enable/Disable Settings control the same parameters as other settings such as the Printer Condition Settings. The settings are linked together (changing one setting changes the other).

---

## User Control

### Disabling of Printing by Invalid User

Printing by users who do not enter valid user information in the printer driver or who are not stored in the machine for FTP push print or other direct print jobs can be prohibited.

To enable this setting, select the checkbox  and touch the [OK] key.

---

## Operation Settings

### Cancel Auto Clear Timer

This setting is used to disable Auto Clear.

To enable this setting, select the checkbox  and touch the [OK] key.

### Disabling of Job Priority Operation

The job priority function can be disabled. When this is done, the [Priority] key will not appear in the job status screen.

To enable this setting, select the checkbox  and touch the [OK] key.

### Disabling of Bypass Printing

This setting is used to disable bypass printing (printing other jobs ahead of a job that has been stopped\* because the paper required for the job is not in any of the trays).

To enable this setting, select the checkbox  and touch the [OK] key.

\* This does not include cases where the paper ran out during the job.

### Disable Auto Key Repeat

This setting is used to disable the auto key repeat function.

To enable this setting, select the checkbox  and touch the [OK] key.

### Disabling of Clock Adjustment

This setting is used to prohibit changing of the date and time.

To enable this setting, select the checkbox  and touch the [OK] key.

### Disabling of Covers/Inserts Mode

This setting is used to prohibit the use of the covers and inserts function.

To enable this setting, select the checkbox  and touch the [OK] key.

---

## Device Control

### Disabling of Document Feeder

Use this setting to prohibit the use of the automatic document feeder, such as when the feeder malfunctions. (When the setting is enabled, scanning is still possible using the document glass.)

To enable this setting, select the checkbox  and touch the [OK] key.

### Disabling of Duplex

This is used to disable two-sided printing, such as when the duplex module malfunctions.

To enable this setting, select the checkbox  and touch the [OK] key.

### Disabling of Large Capacity Cassette

**(When a large capacity tray is installed.)**

This setting is used to prohibit the use of the large capacity tray, such as when the cassette malfunctions.

To enable this setting, select the checkbox  and touch the [OK] key.

### Disabling of Optional Paper Drawer

**(When an optional paper drawer is installed.)**

This setting is used to disable the optional paper drawer, such as when it malfunctions.

To enable this setting, select the checkbox  and touch the [OK] key.

## Disabling of Tray Setting

This setting is used to prohibit tray settings.

To enable this setting, select the checkbox  and touch the [OK] key.

## Disabling of Finisher

(When a saddle stitch finisher or finisher is installed.)

This setting is used to disable the saddle stitch finisher or finisher, such as when the unit malfunctions.

To enable this setting, select the checkbox  and touch the [OK] key.

## Disabling of Offset

This setting is used to disable the offset function.

To enable this setting, select the checkbox  and touch the [OK] key.

## Disabling of Stapler

(When a saddle stitch finisher or finisher is installed.)

This setting is used to prohibit stapling, such as when the stapler unit of the finisher or the saddle stitch finisher malfunctions.

To enable this setting, select the checkbox  and touch the [OK] key.

## Disabling of Punch

(When a punch module is installed.)

This setting is used to prohibit punching, such as when the punch module of the finisher or the saddle stitch finisher malfunctions.

To enable this setting, select the checkbox  and touch the [OK] key.

## Disabling of Color Mode

(When a color-related problem has occurred.)

When a color-related problem has occurred and printing is not possible, the use of color mode can be prohibited on an emergency basis and only black and white printing allowed.

To enable this setting, select the checkbox  and touch the [OK] key.



This function is only for use as an emergency measure. Once this setting is enabled, only a service technician can cancel the setting. Promptly contact your dealer or nearest SHARP service department to have a service technician cancel the setting and resolve the color-related problem.

## Disabling of Master Machine Mode

This prohibits the use of the machine as a master machine for tandem printing.

To enable this setting, select the checkbox  and touch the [OK] key. (Normally this setting is not necessary.)

## Disabling of Slave Machine Mode

This prohibits the use of the machine as a slave machine for tandem printing.

To enable this setting, select the checkbox  and touch the [OK] key. (Normally this setting is not necessary.)

---

## Copy Settings

### Disable Copy in Different Size/Direction

This is used to prohibit copying when the paper and original are placed in different orientations or the proper size of paper is not loaded.

To enable this setting, select the checkbox  and touch the [OK] key.



This setting is only effective when "Rotation Copy Setting" (page 96) is disabled.

### Disabling Deletion of Job Programs

This is used to prohibit the deletion and changing of copy settings stored in job programs.

To enable this setting, select the checkbox  and touch the [OK] key.

### Disabling of Bypass-Tray in Duplex Copy

This is used to prohibit the use of the bypass tray when making two-sided copies.

The bypass tray is often used to feed label sheets, transparency film, and other special papers for which two-sided copying is prohibited. If one of these special papers enters the reversing unit, a misfeed or damage to the unit may result. If special papers for which two-sided copying is prohibited are often used, it is recommended that you enable this setting.

To enable this setting, select the checkbox  and touch the [OK] key.

## Disabling of Auto Paper Selection

This setting is used to disable the Auto Paper Selection function.

When this setting is enabled, automatic selection of paper that is the same size as the original on the document glass or in the automatic document feeder does not take place.

To enable this setting, select the checkbox  and touch the [OK] key.

---

## Printer settings

### Prohibit Notice Page Printing

This setting is used to disable printing of notice pages.

To enable this setting, select the checkbox  and touch the [OK] key.

### Prohibit Test Page Printing

This setting is used to disable printing of test pages. When this setting is enabled, "Printer Test Page" in the system settings cannot be used to print test pages.

To enable this setting, select the checkbox  and touch the [OK] key.

### Exclude Bypass-Tray from Auto Paper Select

When paper selection is set to auto, this setting excludes the bypass tray from the trays that can be selected. It is recommended that you enable this setting when special paper is frequently loaded in the bypass tray.

To enable this setting, select the checkbox  and touch the [OK] key.

---

## Image Send Settings

### Disable Switching of Display Order

This is used to prohibit changes to the order of display (order search number, ascending, descending) in the Address Book.

When this setting is enabled, touching a tab on the Address Book screen does not change the order. The currently selected display order will be the order that is used after the setting is selected.

To enable this setting, select the checkbox  and touch the [OK] key.

## Disable Scan Function

This is used to disable PC scan and USB memory scan.

When these modes are disabled, they are grayed out when the mode is selected in the base screen.

Select the checkboxes  of the modes that you wish to disable and touch the [OK] key.

## Settings to Disable the Registration of Destination

This is used to prohibit the storing of destinations. Storing from the machine, storing from the Web page, and storing from a computer can each be separately prohibited.

### Disable Registering Destination from Operation Panel

Disables address control from the machine.

To use this setting, select the desired items  and touch the [OK] key.

- Group
- E-mail
- Internet Fax
- Fax

(When the [Select/Cancel All] key is touched, all settings become . When the key is touched in the checked condition, all settings become .)

### Disable Registering Destination on Web Page (When network connection is enabled.)

Disable address control from the Web page.

To use this setting, select the checkboxes  of the desired items from the following and touch the [OK] key.

- Group
- E-mail
- FTP
- Desktop
- Network folder
- Internet Fax
- Fax

(When the [Select/Cancel All] key is touched, all settings become . When the key is touched in the checked condition, all settings become .)

### Disable Registration Using Network Scan Tools (When network connection is enabled.)

Disable address control from the Network Scanner Tool.

To enable this setting, select the checkbox  and touch the [OK] key.

## Settings to Disable Transmission

These settings are used to disable the following transmission operations.

### Disable [Resend] on Fax/Image Send Mode

Disable the use of the [Resend] key on the basic screen of image send mode.

To enable this setting, select the checkbox  and touch the [OK] key.

### Disable selection from the Address Book

This is used to disable selecting the destination from the Address Book.

To use this setting, select the checkboxes  of the desired items from the following and touch the [OK] key.

- E-mail
- FTP
- Desktop
- Network Folder
- Internet Fax
- Fax

(When the [Select/Cancel All] key is touched, all settings become . When the key is touched in the checked condition, all settings become .)

### Disable Direct Entry

This prohibits the direct entry of the address.

To use this setting, select the checkboxes  of the desired items from the following and touch the [OK] key.

- E-mail
- Internet Fax
- Fax

(When the [Select/Cancel All] key is touched, all settings become . When the key is touched in the checked condition, all settings become .)

### Disable PC-I-Fax Transmission

**(When Internet fax expansion kit is installed.)**

Disable transmission from PC-I-Fax.

To enable this setting, select the checkbox  and touch the [OK] key.

### Disable PC-Fax Transmission

**(When the facsimile expansion kit is installed.)**

Disable transmission from PC-Fax.

To enable this setting, select the checkbox  and touch the [OK] key.

---

## Document Filing Settings

### Disable Stamp for Reprinting

When a stored file is called up and printed, this setting prohibits the selection of a "Stamp" setting in the special modes. If a stamp setting is already selected, it will not be possible to change the stamp setting.

This function can be used to prevent inconsistencies in the printed information, such as that of the original date in the file and the date the file is called up and printed.

To enable this setting, select the checkbox  and touch the [OK] key.

### Batch Print Settings

When printing files by batch printing, this setting is used to prohibit the selection of the [All Users] key and the [User Unknown] key in the user selection screen.

Select the checkboxes  of the items below that you wish to prohibit and touch the [OK] key.

- Selection of [All Users] is not allowed.
- Selection of [User Unknown] is not allowed.

---

---

# Change Administrator Password

This is used to change the administrator password. Touch the [Change Administrator Password] key and configure the settings.

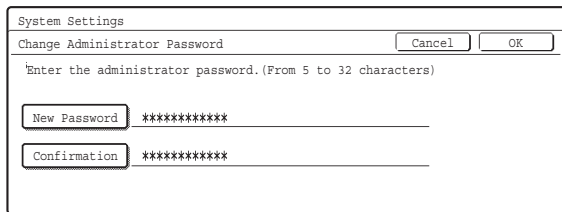

The screenshot shows a dialog box titled "System Settings" with the subtitle "Change Administrator Password". At the top right are "Cancel" and "OK" buttons. Below the subtitle is the instruction "Enter the administrator password. (From 5 to 32 characters)". There are two input fields: "New Password" and "Confirmation", both containing a series of asterisks to represent masked text.

## 1 Touch the [New Password] key and enter the new password.

Enter 5 to 32 characters for the password and touch the [OK] key.

## 2 Touch the [Confirmation] key and enter the password again.

## 3 Touch the [OK] key.



- For the procedure for entering text, see "6. ENTERING TEXT" in the User's Guide.
- For the factory default administrator password, see "TO THE ADMINISTRATOR OF THE MACHINE" in the Safety Guide.
- When changing the password, be sure to remember the new password.
- It is recommended that you periodically change the administrator password.

---

---

# Product Key

The procedures for entering the product keys of the expansion kits are explained below. Touch the [Product Key] key and configure the settings.



- Depending on the peripheral devices installed, it may not be possible to use some settings.
- For the product key to be entered, contact your dealer.

---

## Network Scanner Expansion Kit

Enter the product key for using the machine as a network scanner.

Enter the product key with the numeric keys and touch the [Enter] key.

---

## Printer Expansion Kit

Enter the product key for using the machine as a PCL printer.

Enter the product key with the numeric keys and touch the [Enter] key.

---

## PS3 Expansion Kit

Enter the product key for using the machine as a PostScript compatible printer.

Enter the product key with the numeric keys and touch the [Enter] key.

---

## Internet Fax Expansion Kit

Enter the product key for using the machine as an Internet fax.

Enter the product key with the numeric keys and touch the [Enter] key.

---

## E-mail Alert and Status

Enter the product key for using Status Message /Alert Message on the machine.

Enter the product key with the numeric keys and touch the [Enter] key.



When the facsimile expansion kit is installed, this is displayed as "Status Message".

---

## Application Integration Module

Enter the product key to enable linked machine - PC application processing.

Enter the product key with the numeric keys and touch the [Enter] key.

---

## Serial Number

This displays the serial number that is required to obtain the product key.

---

---

# Storing/Calling of System Settings

The current system settings can be stored, previously stored system settings can be called up, and the factory default system settings can be restored. Touch the [Storing/Calling of system settings] key and configure the settings.

---

## Restore Factory Defaults

This is used to return the system settings to the factory default settings. If you wish to create a record of the current settings before restoring the factory default settings, print the current settings using "[List Print \(Administrator\)](#)" (page 116) in the system settings (administrator).



After executing this function, exit the system settings, turn off the [POWER] key (⏻), wait a brief interval, and then turn the [POWER] key (⏻) back on to make the factory default settings take effect.

---

## Store Current Configuration

This is used to store the currently configured system settings. The stored settings will be retained even if the [POWER] key (⏻) is turned off. To call up the stored settings, use "[Restore Configuration](#)" which is explained below.

### Items not stored

- Network Settings: These are not stored as unexpected settings may cause damage to the network.
- Product Keys: Product Keys are not stored as reissue of keys may be necessary.

---

## Restore Configuration

This is used to call up and restore settings that were stored using "[Store Current Configuration](#)". The current settings will change to the settings called up from memory.

**SHARP**<sup>®</sup>

MODEL: MX-2300N  
MX-2700N

# Copier Guide





---

---

# TABLE OF CONTENTS

<b>ABOUT THIS MANUAL</b> .....	3
• <b>MANUALS PROVIDED WITH THE MACHINE</b> ...	3

## **1 BASIC PROCEDURE FOR MAKING COPIES**

<b>BASE SCREEN OF COPY MODE</b> .....	5
<b>COPYING SEQUENCE</b> .....	8
<b>MAKING COPIES</b> .....	11
• <b>USING THE AUTOMATIC DOCUMENT FEEDER TO MAKE COPIES</b> .....	11
• <b>MAKING A COPY USING THE DOCUMENT GLASS</b> .....	12
<b>AUTOMATIC 2-SIDED COPYING</b> .....	15
• <b>USING THE AUTOMATIC DOCUMENT FEEDER TO MAKE 2-SIDED COPIES</b> .....	15
• <b>AUTOMATIC 2-SIDED COPYING USING THE DOCUMENT GLASS</b> .....	18
<b>COPY COLOR MODES</b> .....	21
• <b>SELECTING THE COLOR MODE</b> .....	21
<b>CHANGING THE EXPOSURE AND EXPOSURE MODE</b> .....	23
• <b>AUTOMATIC ADJUSTMENT OF THE EXPOSURE AND EXPOSURE MODE</b> .....	23
• <b>SELECTING THE EXPOSURE MODE AND MANUALLY ADJUSTING THE EXPOSURE LEVEL</b> .....	23
<b>REDUCTION/ENLARGEMENT/ZOOM</b> .....	26
• <b>AUTOMATIC RATIO SELECTION (Auto Image)</b> .....	26
• <b>MANUALLY SELECTING THE RATIO (Preset ratios/Zoom)</b> .....	27
• <b>ENLARGING/REDUCING THE LENGTH AND WIDTH SEPARATELY (XY Zoom)</b> .....	30
<b>ORIGINAL SIZES</b> .....	33
• <b>CHECKING THE ORIGINAL SIZE</b> .....	33
• <b>SPECIFYING THE ORIGINAL SIZE</b> .....	35
• <b>STORING FREQUENTLY USED ORIGINAL SIZES</b> .....	36
<b>OUTPUT</b> .....	42
• <b>OUTPUT MODES</b> .....	43
<b>MAKING COPIES USING THE BYPASS TRAY (Copying on special papers)</b> .....	46
<b>INTERRUPTING A COPY RUN (Interrupt copy)</b> ...	48

<b>JOB STATUS SCREEN</b> .....	49
• <b>JOB QUEUE SCREEN AND COMPLETED JOB SCREEN</b> .....	49
• <b>WHEN THE DOCUMENT FILING FUNCTION IS USED</b> .....	53

## **2 CONVENIENT COPY FUNCTIONS**

<b>SPECIAL MODES</b> .....	54
• <b>[Image Edit] KEY AND [Color Adjustments] KEY</b> ..	57
<b>ADDING MARGINS (Margin Shift)</b> .....	59
<b>ERASING PERIPHERAL SHADOWS (Erase)</b> .....	61
<b>COPYING EACH FACING PAGE OF A BOUND DOCUMENT (Dual Page Copy)</b> .....	63
<b>MAKING COPIES IN PAMPHLET FORMAT (Pamphlet Copy)</b> .....	65
<b>COPYING A LARGE NUMBER OF ORIGINALS AT ONCE (Job Build)</b> .....	69
<b>USING TWO MACHINES TO COPY A LARGE NUMBER OF ORIGINALS (Tandem Copy)</b> .....	71
<b>USING A DIFFERENT PAPER TYPE FOR COVERS (Covers/Inserts)</b> .....	74
• <b>INSERTING COVERS IN COPIES (Cover Settings)</b> .....	75
• <b>INSERTING INSERT SHEETS IN COPIES (Insert Settings)</b> .....	78
• <b>CHANGING COVER/INSERT SETTINGS (Page Layout)</b> .....	81
<b>ADDING INSERTS WHEN COPYING ON TRANSPARENCY FILM (Transparency Inserts)</b> ...	85
<b>COPYING MULTIPLE PAGES ONTO ONE SHEET OF PAPER (Multi Shot)</b> .....	88
<b>COPYING A PAMPHLET (Book Copy)</b> .....	91
<b>COPYING CAPTIONS ONTO TAB PAPER (Tab Copy)</b> .....	95
• <b>RELATION BETWEEN THE ORIGINALS AND THE TAB PAPER</b> .....	95
<b>COPYING BOTH SIDES OF A CARD ON ONE SHEET OF PAPER (Card Shot)</b> .....	99
<b>PRINTING THE DATE AND A STAMP ON COPIES (Stamp)</b> .....	102
• <b>ADDING THE DATE TO COPIES (Date)</b> .....	103
• <b>STAMPING COPIES (Stamp)</b> .....	107
• <b>PRINTING PAGE NUMBERS ON COPIES (Page Numbering)</b> .....	110
• <b>PRINTING TEXT ON COPIES (Text)</b> .....	116

<b>CHECKING THE STAMP LAYOUT (Layout) . . . . .</b>	<b>122</b>
<b>REPEATING PHOTOS ON A COPY (Photo Repeat) . . . . .</b>	<b>124</b>
<b>CREATING A LARGE POSTER (Multi-Page Enlargement) . . . . .</b>	<b>127</b>
<b>INVERTING THE IMAGE (Mirror Image) . . . . .</b>	<b>130</b>
<b>COPYING AN 11" x 17" SIZE ORIGINAL WITHOUT CUTTING OFF THE EDGES (11x17 Full Bleed) . . . . .</b>	<b>132</b>
<b>COPYING IN THE CENTER OF THE PAPER (Centering) . . . . .</b>	<b>135</b>
<b>REVERSING WHITE AND BLACK IN A COPY (B/W Reverse) . . . . .</b>	<b>137</b>
<b>ADJUSTING RED/GREEN/BLUE IN COPIES (RGB Adjust) . . . . .</b>	<b>139</b>
<b>ADJUSTING THE SHARPNESS OF AN IMAGE (Sharpness) . . . . .</b>	<b>141</b>
<b>WHITENING FAINT COLORS IN COPIES (Suppress Background) . . . . .</b>	<b>143</b>
<b>ADJUSTING THE COLOR (Color Balance) . . . . .</b>	<b>145</b>
<b>ADJUSTING THE BRIGHTNESS OF A COPY (Brightness) . . . . .</b>	<b>147</b>
<b>ADJUSTING THE INTENSITY OF A COPY (Intensity) . . . . .</b>	<b>149</b>
<b>CHECKING COPIES BEFORE PRINTING (Proof Copy) . . . . .</b>	<b>151</b>
<b>COPYING ORIGINALS OF DIFFERENT SIZES (Mixed Size Original) . . . . .</b>	<b>154</b>
<b>COPYING THIN ORIGINALS (Slow Scan Mode) . .</b>	<b>157</b>
<b>STORING COPY OPERATIONS (Job Programs) .</b>	<b>159</b>
• <b>STORING A JOB PROGRAM . . . . .</b>	<b>160</b>
• <b>DELETING A JOB PROGRAM . . . . .</b>	<b>161</b>
<b>APPENDIX . . . . .</b>	<b>163</b>

---

---

# ABOUT THIS MANUAL

## Please note

---

- Considerable care has been taken in preparing this manual. If you have any comments or concerns about the manual, please contact your dealer or nearest SHARP Service Department.
- This product has undergone strict quality control and inspection procedures. In the unlikely event that a defect or other problem is discovered, please contact your dealer or nearest SHARP Service Department.
- Aside from instances provided for by law, SHARP is not responsible for failures occurring during the use of the product or its options, or failures due to incorrect operation of the product and its options, or other failures, or for any damage that occurs due to use of the product.

## Warning

---

- Reproduction, adaptation or translation of the contents of the manual without prior written permission is prohibited, except as allowed under copyright laws.
- All information in this manual is subject to change without notice.

## Illustrations and the operation panel and touch panel in this manual

---

The peripheral devices are generally optional, however, some models include certain peripheral devices as standard equipment. The explanations in this manual assume that a right tray and stand/2 x 500 sheet paper drawer are installed.

To further explain certain functions and uses, some explanations assume that additional peripheral devices are installed.

The display screens, messages, and key names shown in the manual may differ from those on the actual machine due to product improvements and modifications.
---

# MANUALS PROVIDED WITH THE MACHINE

Printed manuals and manuals stored in PDF format on the machine's hard drive are provided with the machine. When using the machine, read the appropriate manual for the feature you are using.

## Printed manuals

Manual name	Contents
<b>Safety Guide</b>	This manual contains instructions for using the machine safely and lists the specifications of the machine and its peripheral devices.
<b>Software Setup Guide</b>	This manual explains how to install the software and configure settings to use the machine as a printer or scanner.
<b>Quick Start Guide</b>	This manual provides easy-to-understand explanations of all the functions of the machine in a single volume. Detailed explanations of each of the functions can be found in the manuals in PDF format.
<b>Troubleshooting</b>	This manual explains how to remove paper misfeeds and provides answers to frequently asked questions regarding the operation of the machine in each mode. Refer to this manual when you have difficulty using the machine.
<b>Facsimile Quick Reference Guide</b>	This manual explains the basic procedures for using the fax function of the machine, and provides an overview of the features of the fax function, troubleshooting procedures, and specifications. For detailed information on using the fax function and the system settings for fax, see the "Facsimile Guide" in PDF format.





## Operation manuals in PDF format

The manuals in PDF format provide detailed explanations of the procedures for using the machine in each mode. To view the PDF manuals, download them from the hard drive in the machine. The procedure for downloading the manuals is explained in "How to download the manuals in PDF format" in the Quick Start Guide.

Manual name	Contents
<b>User's Guide</b>	This manual provides information, such as basic operation procedures, how to load paper, and machine maintenance.
<b>Copier Guide (This manual)</b>	This manual provides detailed explanations of the procedures for using the copy function.
<b>Printer Guide</b>	This manual provides detailed explanations of the procedures for using the printer function.
<b>Facsimile Guide</b>	This manual provides detailed explanations of the procedures for using the fax function and the "System Settings" that are related to fax.
<b>Scanner Guide</b>	This manual provides detailed explanations of the procedures for using the scanner function and the Internet fax function.
<b>Document Filing Guide</b>	This manual provides detailed explanations of the procedures for using the document filing function. The document filing function allows you to save the document data of a copy or fax job, or the data of a print job, as a file on the machine's hard drive. The file can be called up as needed.
<b>System Settings Guide</b>	This manual explains the "System Settings", which are used to configure a variety of parameters to suit the aims and the needs of your workplace. Current settings can be displayed or printed out from the "System Settings".

## Icons used in the manuals

The icons in the manuals indicate the following types of information:

	This alerts you to a situation where there is a risk of machine damage or failure.		This indicates the name of a system setting and a provides a brief explanation of the setting. For detailed information on each system setting, see the System Settings Guide. <b>When "System Settings:" appears:</b> A general setting is explained. <b>When "System Settings (Administrator):" appears:</b> A setting that can only be configured by an administrator is explained.
	This provides a supplemental explanation of a function or procedure.		
	This explains how to cancel or correct an operation.		

# 1

# BASIC PROCEDURE FOR MAKING COPIES

This chapter explains the basic procedures for making copies, including selection of the copy ratio and other copy settings.

## BASE SCREEN OF COPY MODE

When the [COPY] key is pressed on the operation panel, the base screen of copy mode appears. The base screen shows messages and keys necessary for copying, and settings that have been selected. Selections are made by touching the displayed keys.

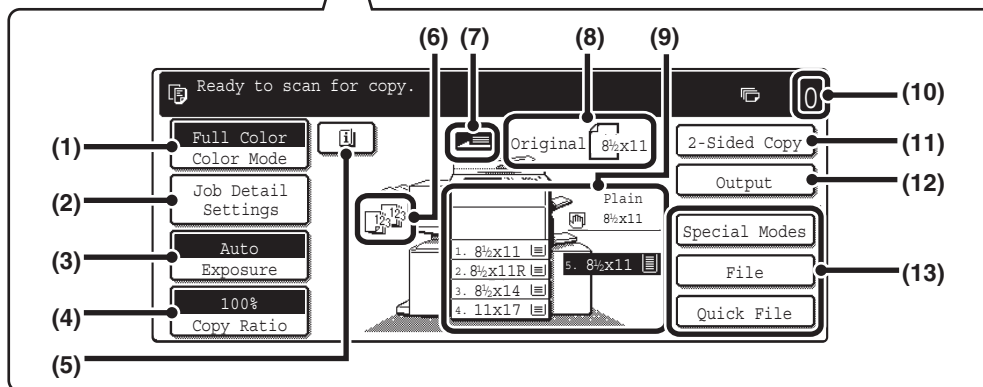
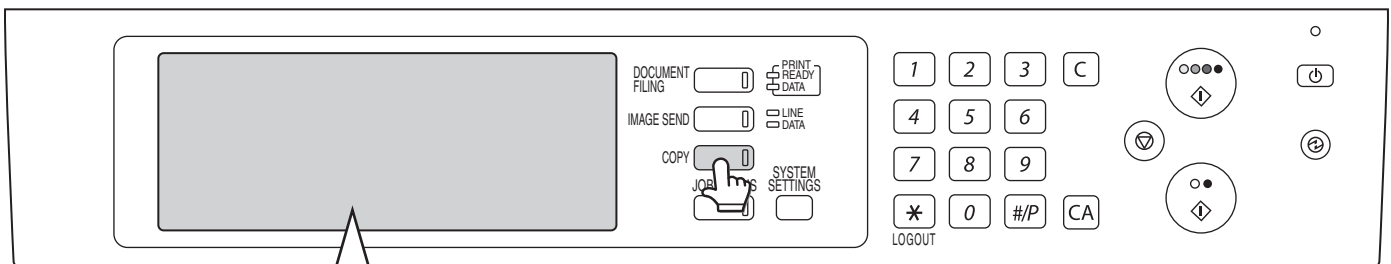

The screen at left shows the machine with the saddle stitch finisher, stand/2 x 500 sheet paper drawer, large capacity tray and right tray installed. The image will vary depending on the equipment installed.

- (1) **[Color Mode] key**  
Touch this to change the color mode.  
➤ [COPY COLOR MODES](#) (page 21)
- (2) **[Job Detail Settings] key**  
Touch this key to select original settings, paper settings, and special modes.  
➤ [\[Job Detail Settings\] key](#) (page 6)
- (3) **[Exposure] key**  
This shows the current copy exposure and exposure mode settings. Touch this key to change the exposure or exposure mode setting.  
➤ [CHANGING THE EXPOSURE AND EXPOSURE MODE](#) (page 23)
- (4) **[Copy Ratio] key**  
This shows the current copy ratio. Touch this key to adjust the copy ratio.  
➤ [REDUCTION/ENLARGEMENT/ZOOM](#) (page 26)
- (5) **[Special Modes] key**  
This key appears when a special mode is selected. Touch this key to display a list of the selected modes and settings.  
➤ [Checking which special modes are selected](#) (page 58)
- (6) **Output display**  
When one or more output functions such as sort, group, staple sort, or saddle stitch have been selected, this shows the icons of the selected functions.  
➤ [OUTPUT](#) (page 42)
- (7) **Original feed display**  
This appears when an original has been inserted in the document feeder tray.
- (8) **Original size display**  
This shows the size of the original. When the original size is set manually, the display shows "Manual". When an original is not placed, nothing appears.  
➤ [ORIGINAL SIZES](#) (page 33)

**(9) Paper select display**

This shows the size of paper loaded in each tray.  
The selected tray is highlighted.  
The approximate amount of paper in each tray is indicated by [≡]. To display the paper size setting screen for a tray, touch the tray.

**(10) Number of copies display**

This shows the number of copies set.

**(11) [2-Sided Copy] key**

Touch this to make 2-sided copies.  
➤ AUTOMATIC 2-SIDED COPYING (page 15)

**(12) [Output] key**

Touch this to select an output function such as sort, group, offset, staple sort, saddle stitch, or punch.  
➤ OUTPUT (page 42)

**(13) Customized keys**

These 3 keys can be changed to show any 3 settings or functions that you like. The keys are changed in "Customize Key Setting" in the system settings (administrator). Normally the following keys appear:  
➤ Customizing displayed keys (page 7)

• **[Special Modes] key**

This is the same [Special Modes] key that appears when the [Job Detail Settings] key is touched.

➤ SPECIAL MODES (page 54)

• **[File] key, [Quick File] key**

Touch either key to use the Quick File or File of the document filing functions. These are the same [File] and [Quick File] keys that appear when the [Special Modes] key is touched. For information on the document filing function, see the Document Filing Guide.

 When the system settings screen is displayed, the base screen of copy mode will not appear even if the [COPY] key is pressed.

## [Job Detail Settings] key

When the [Job Detail Settings] key is touched, keys for selecting the original size and paper settings appear. The [Special Modes] key also appears to allow the selection of special modes. To close the job detail settings screen and return to the base screen, touch the [Job Detail Settings] key once again.

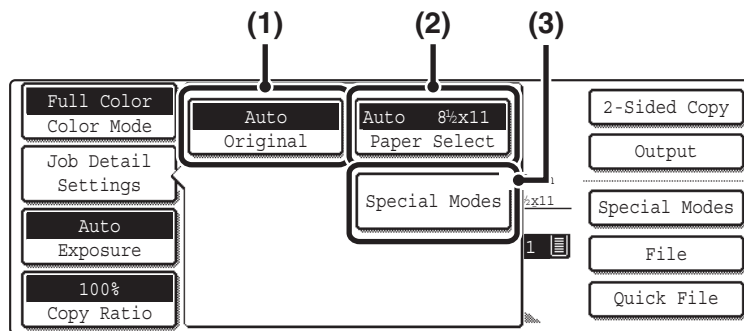

**(1) [Original] key**

Touch this key to select the original size setting.  
➤ ORIGINAL SIZES (page 33)

**(2) [Paper Select] key**

Touch this key to change the paper (tray) that is used. When the key is touched, each tray and the size and type of paper in that tray will appear. Touch the key of the paper tray that you wish to use and then touch the [OK] key. The paper size and paper type settings for trays 1 to 5 are configured in the system settings.  
➤ System Settings Guide "Paper Tray Settings"  
For information on the paper size and paper type settings for the bypass tray, see the "MAKING COPIES USING THE BYPASS TRAY (Copying on special papers)" (page 46).

**(3) [Special Modes] key**

Touch this key to select special modes such as Margin Shift, Edge Erase, and Dual Page Copy.  
➤ SPECIAL MODES (page 54)

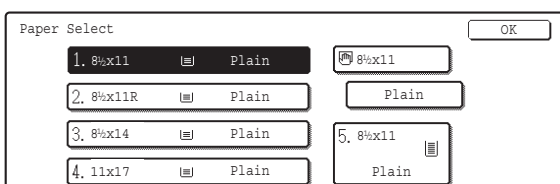

## Customizing displayed keys

Keys of convenient functions (such as special modes) can be displayed in the lower right corner of the screen. Set these keys to functions that you frequently use to access the functions with a single touch. The functions that are shown in the keys are selected with "Customize Key Setting" in the system settings (administrator).

The screen when the customized keys are set to [Special Modes], [Margin Shift], and [Brightness]

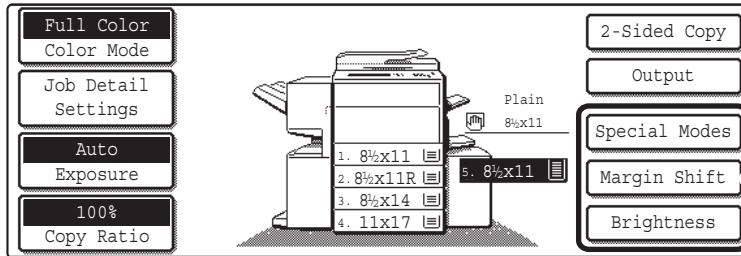

These 3 keys can be changed as desired.



### System Settings (Administrator): Customize Key Setting

This is used to select the customized keys that appear in the base screen.

# COPYING SEQUENCE

Select settings in the order shown below to ensure that the copy operation takes place smoothly. For detailed procedures for selecting the settings, see the explanation of each setting in this guide.

## Place the original.

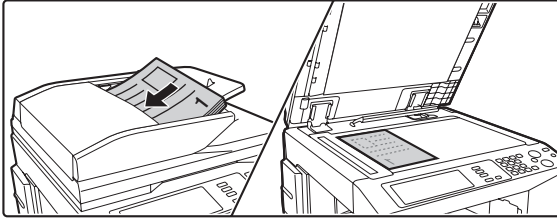

Place the original in the document feeder tray of the automatic document feeder, or on the document glass.

\* Depending on the copy functions used, there are also cases where functions are selected before the original is placed.





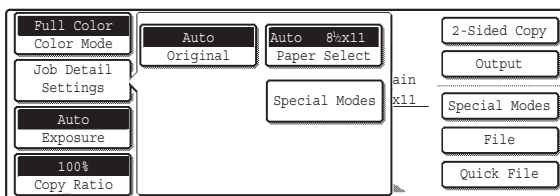

## Basic copy settings



Select the basic copy settings.

The main settings are as follows:

- Color mode  [COPY COLOR MODES](#) (page 21)
- Exposure and exposure mode  [CHANGING THE EXPOSURE AND EXPOSURE MODE](#) (page 23)
- Copy ratio  [REDUCTION/ENLARGEMENT/ZOOM](#) (page 26)
- Original size  [ORIGINAL SIZES](#) (page 33)
- Paper settings



## 2-sided copy settings

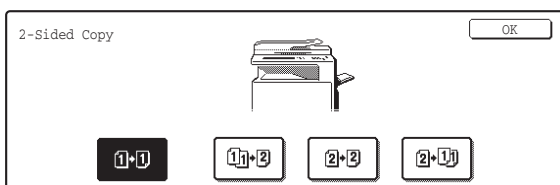

Select settings as needed for 2-sided copying and 2-sided scanning of the original.

-  [AUTOMATIC 2-SIDED COPYING](#) (page 15)





## Output settings

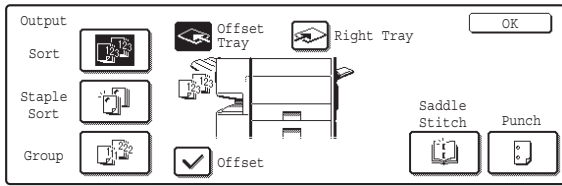

Select copy output settings.

The main settings are as follows:

- Sort mode [Sort mode](#) (page 43)
- Group mode [Group mode](#) (page 43)
- Offset mode [Offset function](#) (page 43)
- Staple sort mode
  - [Staple sort function / Saddle stitch function](#) (page 44)
- Punch function [Punch function](#) (page 45)
- Pamphlet staple function
  - [Staple sort function / Saddle stitch function](#) (page 44)



## Special mode settings

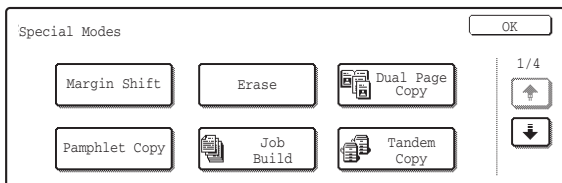

Select special modes such as "Margin Shift" and "Erase".

- [SPECIAL MODES](#) (page 54)



## Number of copies (sets) setting

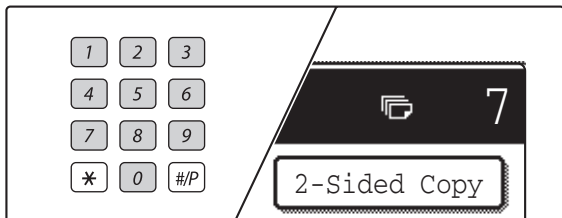

Set the number of copies (number of sets).



## Document filing settings

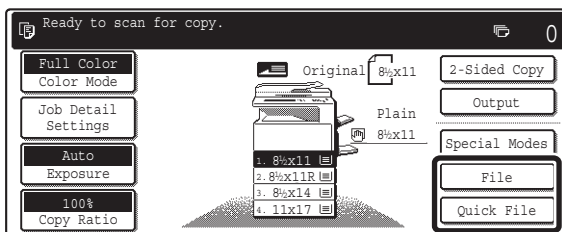

Select document filing settings.

For more information on the document filing function, see the Document Filing Guide.



## Start copying.

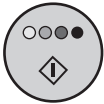



Start color copying.



Start black and white copying.

Start scanning the original(s) and making copies.





When one or more special modes are selected, the  key appears in the base screen. Touch the  key to display a list of the selected special modes. This lets you check what special modes are selected and the settings of each mode.



**To cancel all settings, press the [CLEAR ALL] key ().**

When the [CLEAR ALL] key () is pressed, all settings selected to that point are cleared and you will return to the base screen.

**To stop scanning of the original and copying, press the [STOP] key ().**

When the [STOP] key () is pressed, a message will appear asking you if you want to cancel the job. Touch the [Yes] key in the message screen.

# MAKING COPIES

## USING THE AUTOMATIC DOCUMENT FEEDER TO MAKE COPIES

This section explains how to make copies (1-sided copies of 1-sided originals) using the automatic document feeder.

1

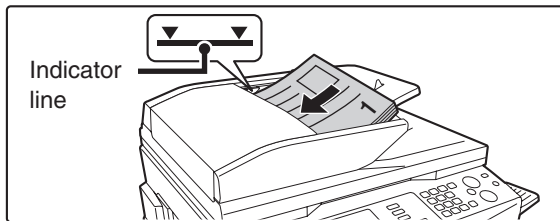

**Place the originals face up in the document feeder tray with the edges aligned evenly.**

Place the originals face up. Insert the originals all the way into the document feeder tray. The stack must not be higher than the indicator line (no more than 100 sheets).

2



- Depending on the size of the placed original, there may be cases where the same size of paper as the original is not selected automatically. In this event, change the paper size manually.
- To change the paper size selection, touch the [Job Detail Settings] key and then the [Paper Select] key, or touch the paper size display (A).

The following screen appears when the [Paper Select] key or the paper size display (A) is touched. Touch the tray key that has the desired paper size and then touch the [OK] key.

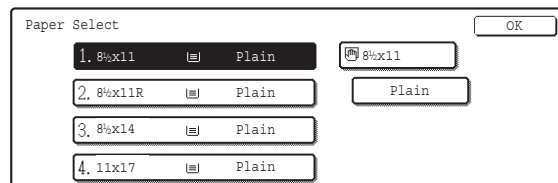

3

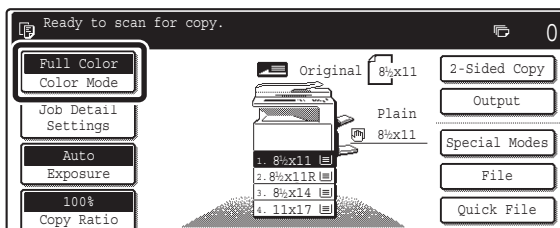

**Check the color mode.**

The currently selected color mode appears.

To change the color mode, touch the [Color Mode] key, touch the [Full Color] key, [Auto] key, [Single Color] key or [2 Color] key, and touch the [OK] key.

[COPY COLOR MODES](#) (page 21)

Full Color: The original is copied in full color.

Auto: Color or black and white is automatically selected when the original is scanned.

Single Color: The original is copied in the selected color only.

2 Color: Only the red areas of the original are changed to the selected color; colors other than red are scanned in black.

4

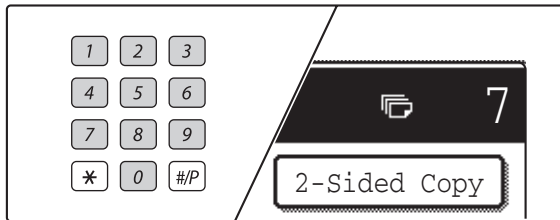

Set the number of copies (sets) with the numeric keys.



- Up to 999 can be set.
- A single copy can be made even if "0" appears for the number of copies.



**If an incorrect number of copies is set...**  
Press the [CLEAR] key (C) and then enter the correct number.

5

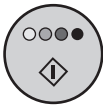

or



Press the [COLOR START] key (●●●●) or the [BLACK & WHITE START] key (●●).



Even if a color mode is selected, copying will take place in black and white if the [BLACK & WHITE START] key (●●) is pressed.



**To cancel scanning of the original and copying...**  
Press the [STOP] key (⊞).

## MAKING A COPY USING THE DOCUMENT GLASS

To make a copy of a book or other thick original that cannot be fed through the automatic document feeder, open the automatic document feeder and place the original on the document glass. This section explains how to make a copy (1-sided copy of a 1-sided original) using the document glass.

1

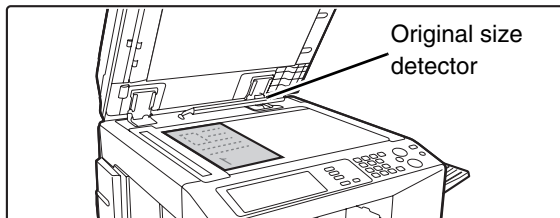

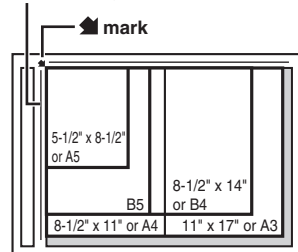

Open the automatic document feeder, place the original face down on the document glass, and then gently close the automatic document feeder.

Document glass scale

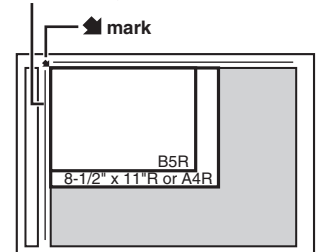

Document glass scale



- Align the corner of the original with the tip of the arrow mark  on the document glass scale.
- Place the original in the appropriate position for its size as shown above.



Do not place any objects under the original size detector. Closing the automatic document feeder with an object underneath may damage the original size detector plate and prevent correct detection of the document size.

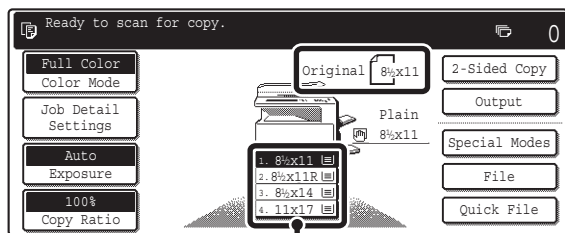

(A)

## Make sure that the automatically selected paper size is the same size as the original.

The selected tray is highlighted. You can also copy onto paper that is a different size than the original.

2



- Depending on the size of the placed original, there may be cases where the same size of paper as the original is not selected automatically. In this event, change the paper size manually.
- To change the paper size selection, touch the [Job Detail Settings] key and then the [Paper Select] key, or touch the paper size display (A).

The following screen appears when the [Paper Select] key or the paper size display (A) is touched. Touch the tray key that has the desired paper size and then touch the [OK] key.

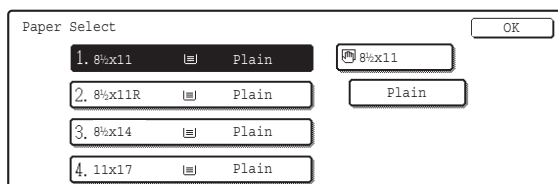

3

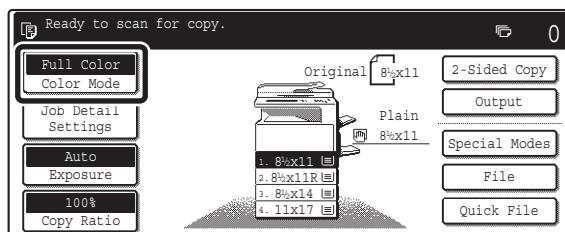

## Check the color mode.

The currently selected color mode appears.

To change the color mode, touch the [Color Mode] key, touch the [Full Color] key, [Auto] key, [Single Color] key or [2 Color] key, and touch the [OK] key.

➡ **COPY COLOR MODES** (page 21)

**Full Color:** The original is copied in full color.

**Auto:** Color or black and white is automatically selected when the original is scanned.

**Single Color:** The original is copied in the selected color only.

**2 Color:** Only the red areas of the original are changed to the selected color; colors other than red are scanned in black.

4

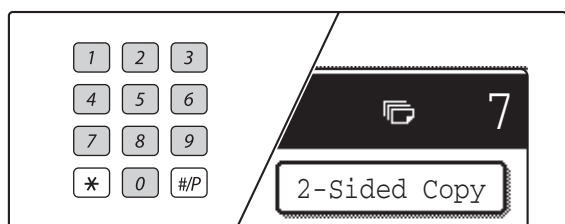

## Set the number of copies (sets) with the numeric keys.



- Up to 999 can be set.
- A single copy can be made even if "0" appears for the number of copies.



### If an incorrect number of copies is set...

Press the [CLEAR] key (C) and then enter the correct number.

5

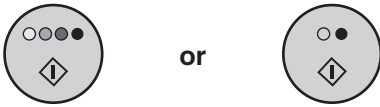

Press the [COLOR START] key (●●●●) or the [BLACK & WHITE START] key (●●).

Scanning begins.

If group copy is selected, copying begins.

If you are using the sort function or other function that requires all originals to be scanned before the copies are printed, you must use the same [START] key that you used to scan the first original to scan each of the remaining originals.



Even if a color mode is selected, copying will take place in black and white if the [BLACK & WHITE START] key (●●) is pressed.

6

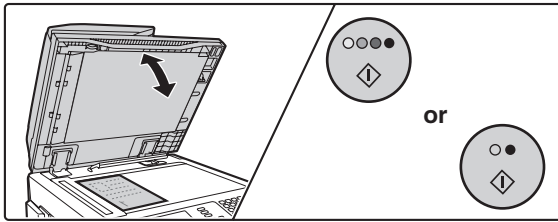

Remove the original and place the next original, and then press the [COLOR START] key (●●●●) or the [BLACK & WHITE START] key (●●).

If you are using the sort function or other function that requires all originals to be scanned before the copies are printed, you must use the same [START] key that you used to scan the first original to scan each of the remaining originals.

Repeat this step until all originals have been scanned.

7

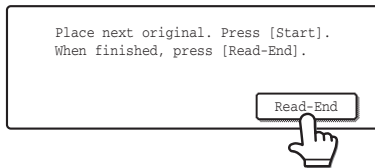

Touch the [Read-End] key.



To cancel scanning of the original and copying... Press the [STOP] key (⏹).

# AUTOMATIC 2-SIDED COPYING

## USING THE AUTOMATIC DOCUMENT FEEDER TO MAKE 2-SIDED COPIES

The following 2-sided copying can be performed automatically. The originals and paper are turned over automatically, allowing easy 2-sided copying.

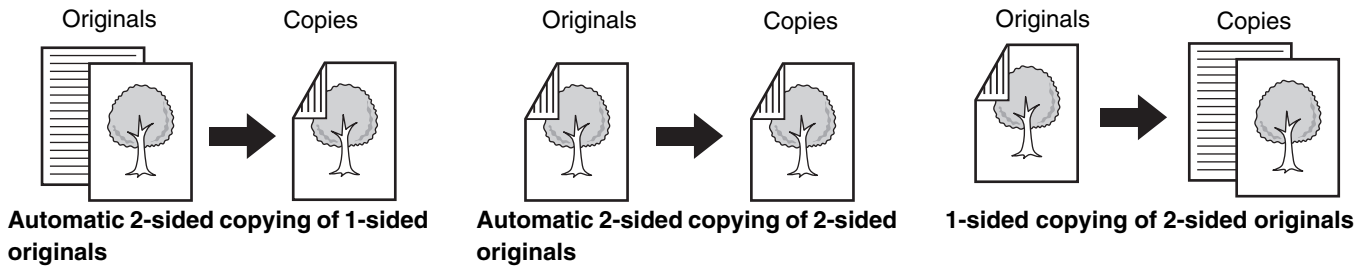

1

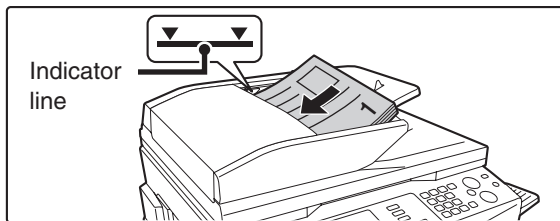

**Place the originals face up in the document feeder tray with the edges aligned evenly.**

Place the originals face up. Insert the originals all the way into the document feeder tray. The stack must not be higher than the indicator line (no more than 100 sheets).

2

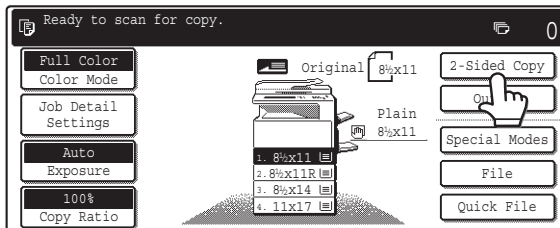

**Touch the [2-Sided Copy] key.**

3

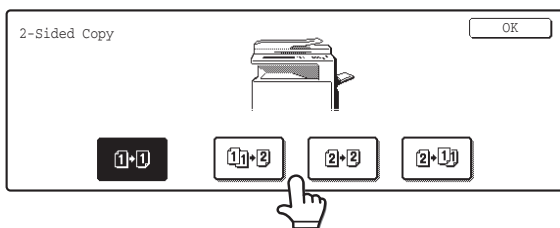

**Select the 2-sided copy mode.**

Touch the key of the 2-sided copy mode that you wish to use.

**1•1** : Automatic 2-sided copying of 1-sided originals

**2•2** : Automatic 2-sided copying of 2-sided originals

**2•1** : 1-sided copying of 2-sided originals



When making automatic 2-sided copies of a 1-sided 11" x 17" (A3) or 8-1/2" x 14" (B4) size portrait original, or when you wish to vertically invert the reverse side of a 2-sided original, touch the [Binding Change] key.

Using the [Binding Change] key (page 17)

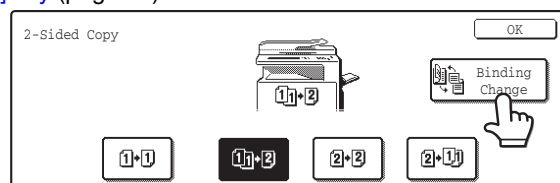

4

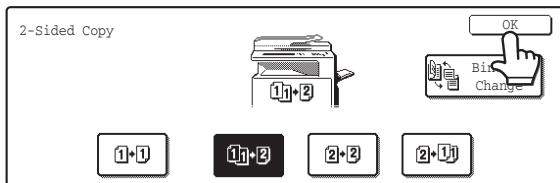

Touch the [OK] key.

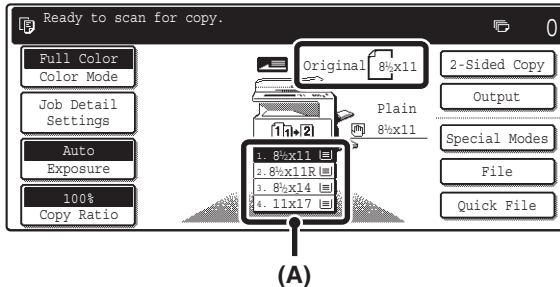

Make sure that the automatically selected paper size is the same size as the original.

The selected tray is highlighted. You can also copy onto paper that is a different size than the original.

5



- The 2-sided copy setting appears at the top of the paper size display (A).
- Depending on the size of the placed original, there may be cases where the same size of paper as the original is not selected automatically. In this event, change the paper size manually.
- To change the paper size selection, touch the [Job Detail Settings] key and then the [Paper Select] key, or touch the paper size display (A).

The following screen appears when the [Paper Select] key or the paper size display (A) is touched. Touch the key of the tray that has the desired paper size and then touch the [OK] key.

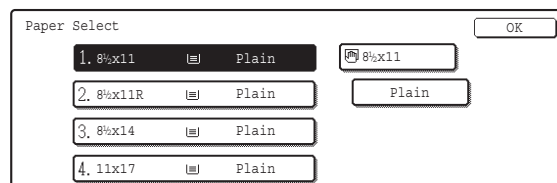

6

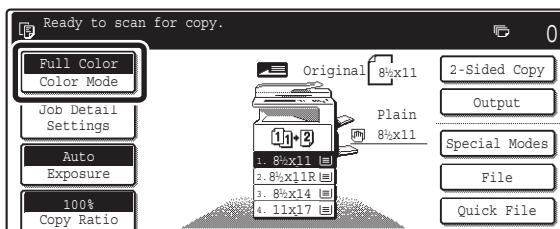

Check the color mode.

The currently selected color mode appears.

To change the color mode, touch the [Color Mode] key, touch the [Full Color] key, [Auto] key, [Single Color] key or [2 Color] key, and touch the [OK] key.

➤ [COPY COLOR MODES](#) (page 21)

Full Color: The original is copied in full color.

Auto: Color or black and white is automatically selected when the original is scanned.

Single Color: The original is copied in the selected color only.

2 Color: Only the red areas of the original are changed to the selected color; colors other than red are scanned in black.



7

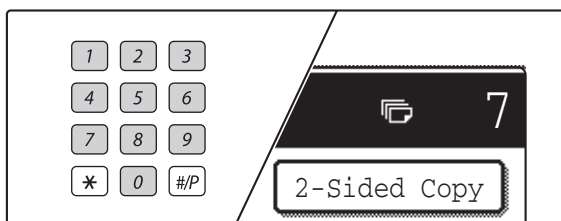

**Set the number of copies (sets) with the numeric keys.**



- Up to 999 can be set.
- If you are only making a single copy, the copy can be made with the copy number display showing "0".



**If an incorrect number of copies is set...**

Press the [CLEAR] key (C) and then enter the correct number.

8

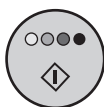

or



**Press the [COLOR START] key (○●●●) or the [BLACK & WHITE START] key (○●).**



**To cancel scanning of the original and copying...**

Press the [STOP] key (⊘).

## Using the [Binding Change] key

Originals	Binding Change is used	Binding Change is not used
	<p>The reverse side is upside down.</p> <p>Select this when the pages will be bound into a tablet.</p>	<p>The reverse side is not upside down.</p> <p>Select this when the pages will be bound into a booklet.</p>

# AUTOMATIC 2-SIDED COPYING USING THE DOCUMENT GLASS

The following 2-sided copying can be performed automatically. The paper is turned over automatically, allowing easy 2-sided copying.

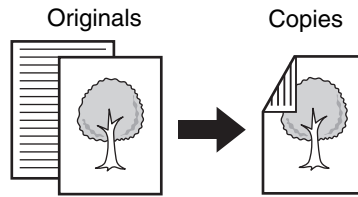

**Automatic 2-sided copying of 1-sided originals**

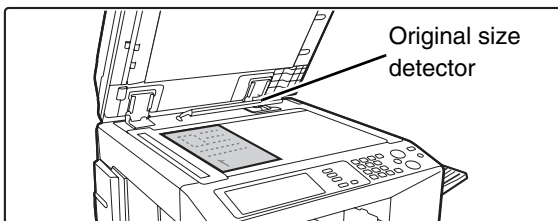

**Open the automatic document feeder, place the original face down on the document glass, and then gently close the automatic document feeder.**

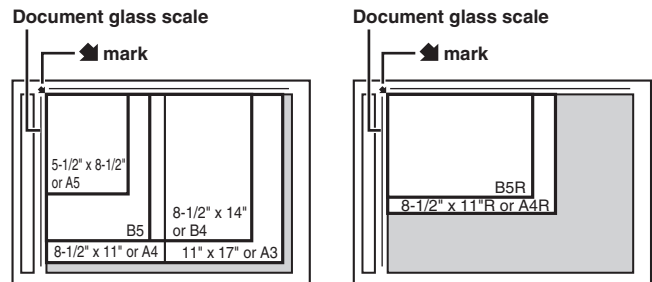

- Align the corner of the original with the tip of the arrow mark  on the document glass scale.
- Place the original in the appropriate position for its size as shown above.



Do not place any objects under the original size detector. Closing the automatic document feeder with an object underneath may damage the original size detector plate and prevent correct detection of the document size.

1

2

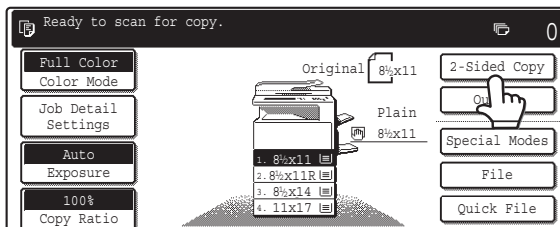

**Touch the [2-Sided Copy] key.**

3

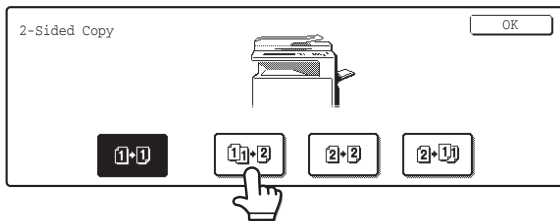

Touch the [1-Side to 2-Side] key.



The [2-Side to 2-Side] key and [2-Side to 1-Side] key cannot be used when copying from the document glass.

4

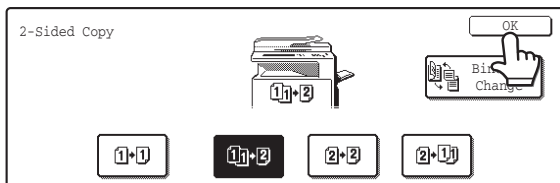

Touch the [OK] key.

5



- The "1-Side to 2-Side" copy setting appears at the top of the paper size display (A).
- Depending on the size of the placed original, there may be cases where the same size of paper as the original is not selected automatically. In this event, change the paper size manually.
- To change the paper size selection, touch the [Job Detail Settings] key and then the [Paper Select] key, or touch the paper size display (A).

The following screen appears when the [Paper Select] key or the paper size display (A) is touched. Touch the tray key that has the desired paper size and then touch the [OK] key.

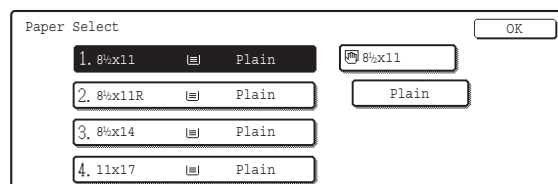

6

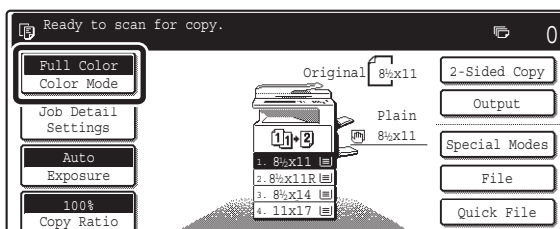

Check the color mode.

The currently selected color mode appears. To change the color mode, touch the [Color Mode] key, touch the [Full Color] key, [Auto] key, [Single Color] key or [2 Color] key, and touch the [OK] key.

**COPY COLOR MODES** (page 21)

Full Color: The original is copied in full color.

Auto: Color or black and white is automatically selected when the original is scanned.

Single Color: The original is copied in the selected color only.

2 Color: Only the red areas of the original are changed to the selected color; colors other than red are scanned in black.

7

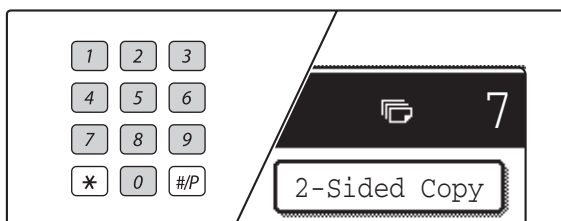

**Set the number of copies (sets) with the numeric keys.**



- Up to 999 can be set.
- A single copy can be made even if "0" appears for the number of copies.



**If an incorrect number of copies is set...**

Press the [CLEAR] key (C) and then enter the correct number.

8

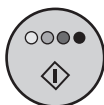

or



**Press the [COLOR START] key (●●●●) or the [BLACK & WHITE START] key (●●).**

Scanning begins.

If you are using the sort function or other function that requires all originals to be scanned before the copies are printed, you must use the same [START] key that you used to scan the first original to scan each of the remaining originals.

9

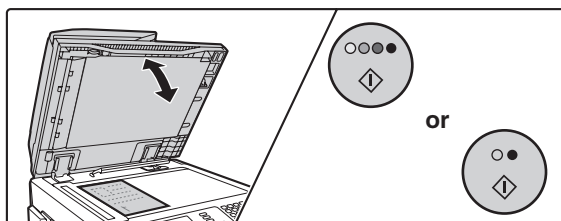

**Remove the original and place the next original, and then press the [COLOR START] key (●●●●) or the [BLACK & WHITE START] key (●●).**

If you are using the sort function or other function that requires all originals to be scanned before the copies are printed, you must use the same [START] key that you used to scan the first original to scan each of the remaining originals.

Repeat this step until all originals have been scanned.

10

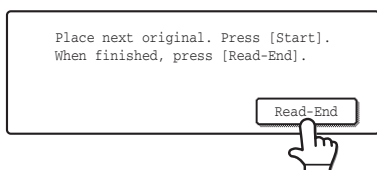

**Touch the [Read-End] key.**



**To cancel scanning of the original and copying...**

Press the [STOP] key (⊘).

# COPY COLOR MODES

This section explains how to select the color mode.

For a color original, set the color mode to Full Color.

If color originals and black and white originals are mixed together, set the color mode to Auto.

<b>Full Color</b>	The original is copied in full color.
<b>Single Color</b>	The original is copied in the selected color only. All colors in the original are changed to the selected color, which can be selected from green, blue, cyan, magenta, or yellow.
<b>2 Color</b>	Only the red areas of the original are changed to the selected color; colors other than red are copied in black. This lets you make copies that are more expressive than black and white copies. Red, green, blue, cyan, magenta, or yellow can be selected.
<b>Auto</b>	A color original is normally copied in Full Color mode when the [COLOR START] key (○●●●) is pressed. However, if color originals and black and white originals are mixed together, follow the steps below to set the color mode to [Auto]. The discrimination point for detecting whether originals are color or black and white can be set using "Detect Standard in Auto Color Mode" in the system settings (administrator).

## SELECTING THE COLOR MODE

1

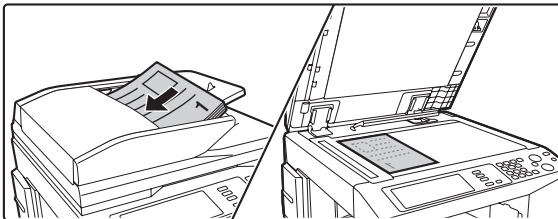

### Place the original.

Place the original face up in the document feeder tray, or face down on the document glass.

2

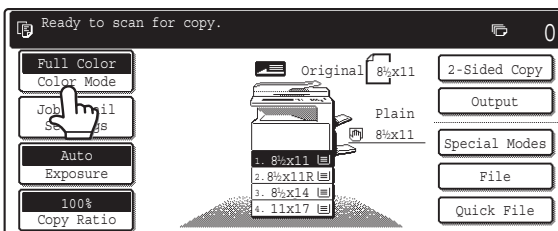

### Touch the [Color Mode] key.

3

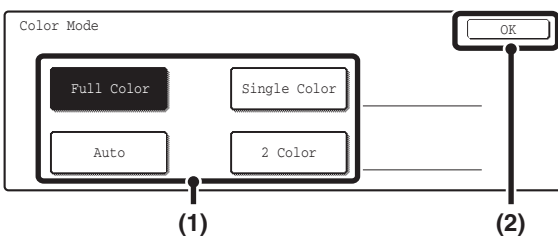

### Set the color mode.

(1) Select the color mode.

(2) Touch the [OK] key.



When auto mode is used, there may be some originals for which the mode is not correctly switched between full color mode and black and white mode. In this event, press the [COLOR START] key (○●●●) and the [BLACK & WHITE START] key (○●) as appropriate to manually switch between color copying and black and white copying.

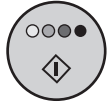

Press the [COLOR START] key (○●●●).

Scanning begins.

- If the originals were placed in the document feeder tray, the originals are copied.
- If you are using the document glass, copy each page one page at a time.



To cancel scanning of the original and copying...

Press the [STOP] key (⏏).



Even if a color mode is selected, copying will take place in black and white if the [BLACK & WHITE START] key (○●) is pressed.



**System Settings (Administrator): Detect Standard in Auto Color Mode**

When the color mode is set to auto, the discrimination point for detecting whether originals are color or black and white can be set to one of 5 levels.

## Selecting single color copying

When [Single Color] is selected for the color mode, the following screen appears. Touch the desired color and touch the [OK] key.

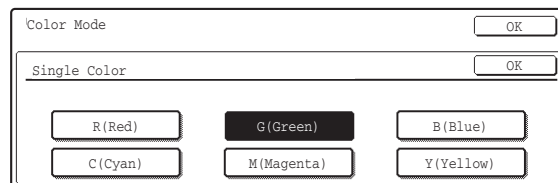

## Selecting 2 color copying

When [2 Color] is selected for the color mode, the following screen appears. Touch the desired colors and touch the [OK] key.

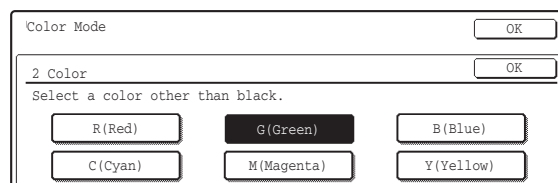

---

---

# CHANGING THE EXPOSURE AND EXPOSURE MODE

The exposure level and exposure mode can be selected to obtain a clear copy.

## AUTOMATIC ADJUSTMENT OF THE EXPOSURE AND EXPOSURE MODE

Automatic exposure adjustment operates by default to automatically adjust the exposure level and mode as appropriate for the original being copied. ("Auto" is displayed.)

When a black and white or full color copy is made, the exposure is automatically adjusted to obtain the best image quality.

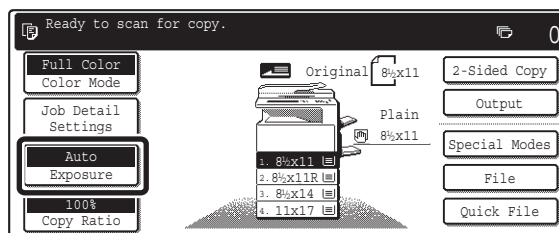

## SELECTING THE EXPOSURE MODE AND MANUALLY ADJUSTING THE EXPOSURE LEVEL

To select the exposure mode, or to manually adjust the exposure level, follow the steps below.

1

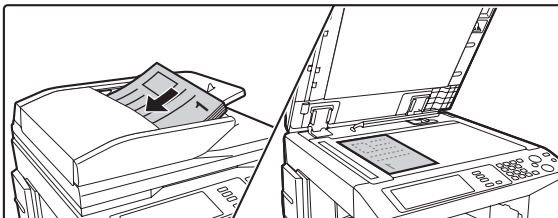

### Place the original.

Place the original face up in the document feeder tray, or face down on the document glass.

2

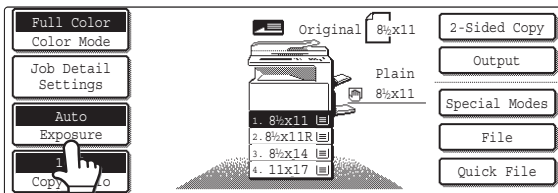

### Touch the [Exposure] key.

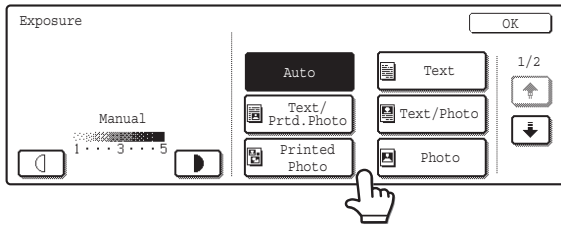

## Select the exposure mode.

Touch the appropriate original type key to select the exposure mode.

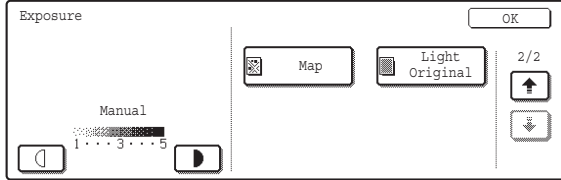

### ● Selecting the exposure mode

Mode	Description
Auto	Normally this setting is selected. When a black and white or full color copy is made, the exposure is automatically adjusted to obtain the best image quality.
Text	Use this mode for regular text documents.
Text/Prt'd. Photo	This mode provides the best balance for copying an original which contains both text and printed photographs, such as a magazine or catalogue.
Text/Photo	This mode provides the best balance for copying an original which contains both text and photographs, such as a text document with a photo pasted on.
Printed photo	This mode is best for copying printed photographs, such as photos in a magazine or catalogue.
Photo	Use this mode to copy photos.
Map	This mode is best for copying the light color shading and fine text found on most maps.
Light Original	Use this mode for originals with light pencil writing.



#### **If [Auto] is selected but the darkness or lightness of the image does not seem quite right...**

If the image seems too light or too dark when [Auto] is selected, the exposure level can be adjusted using "Copy Exposure Adjustment" in the system settings (administrator).





# REDUCTION/ENLARGEMENT/ZOOM

## AUTOMATIC RATIO SELECTION (Auto Image)

This section explains the automatic ratio selection function (Auto Image), which automatically selects the ratio to match the paper size.

The reduction or enlargement ratio is selected automatically based on the original size and the selected paper size.

1

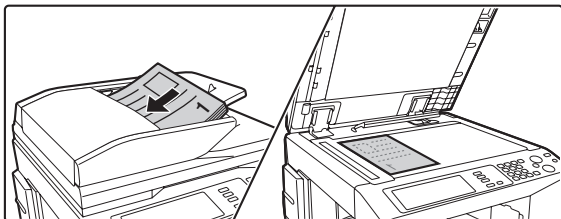

### Place the original.

Place the original face up in the document feeder tray, or face down on the document glass.



Automatic ratio selection cannot be used if the original size or paper size is a non-standard size. If the original size is a non-standard size, automatic ratio selection cannot be used unless the original size is entered manually.

2

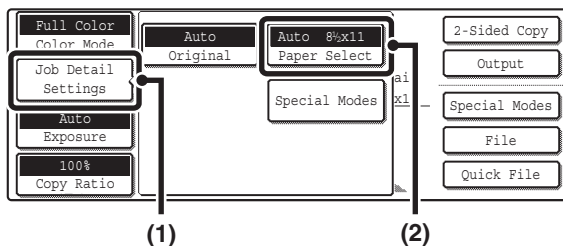

### Open the paper settings screen.

- (1) Touch the [Job Detail Settings] key.
- (2) Touch the [Paper Select] key.

3

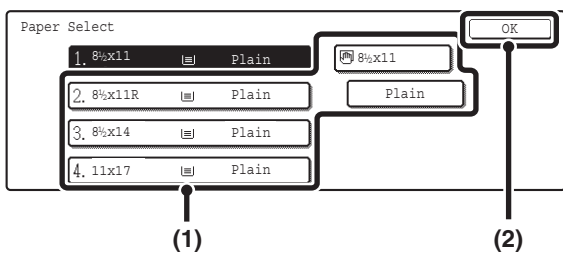

### Set the paper size.

- (1) Touch the tray that has the desired paper size.
- (2) Touch the [OK] key.

When the [OK] key is touched, you will return to the job detail setting screen. Touch the [Job Detail Setting] key to return to the base screen of copy mode.

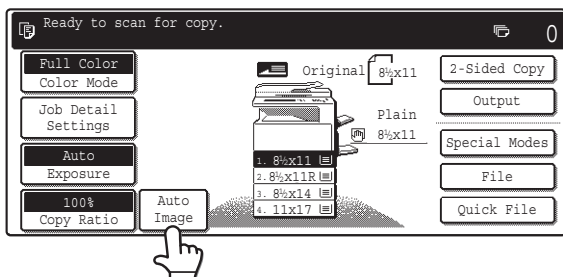

4



### Touch the [Auto Image] key.

A suitable ratio for the original size and the selected paper size will be selected. (The selected ratio will appear in the ratio display.)



If the message "Rotate original from  to 

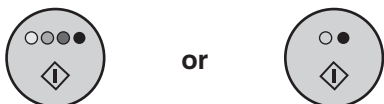

Press the **[COLOR START]** key (○●●●) or the **[BLACK & WHITE START]** key (○●).

Scanning begins.

- If the originals were placed in the document feeder tray, the originals are copied.
- If you placed the original on the document glass, scan each page one page at a time. If you are using the sort function or other function that requires all originals to be scanned before the copies are printed, you must use the same [START] key that you used to scan the first original to scan each of the remaining originals.



**To cancel scanning of the original and copying...**

Press the [STOP] key (⏏).



**To cancel automatic ratio selection...**

Touch the [Auto Image] key so that it is no longer highlighted.

**To return the ratio to 100%...**

To return the ratio setting to 100%, touch the [Copy Ratio] key to display the ratio menu and then touch the [100%] key.

## MANUALLY SELECTING THE RATIO (Preset ratios/Zoom)

The enlargement and reduction keys can be used to select five preset ratios each (from a maximum of 400% to a minimum of 25%).

In addition, the zoom keys can be used to select any ratio from 25% to 400% in increments of 1%.

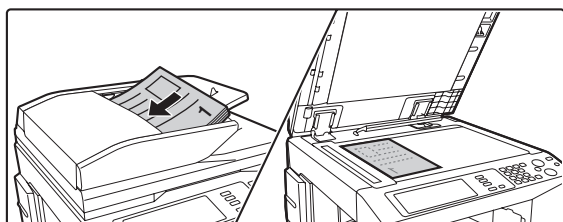

**Place the original.**

Place the original face up in the document feeder tray, or face down on the document glass.



When the automatic document feeder is used, the ratio selection range is 25% to 200%.

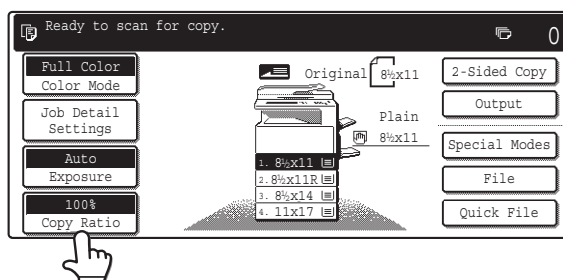

**Touch the [Copy Ratio] key.**

Touch the [Menu] key to select copy ratio menu "1" or "2".

● Menu 1

- Enlargement keys (2 ratios): 121%, 129%
- Reduction keys (2 ratios): 64%, 77%
- Full size key: 100%

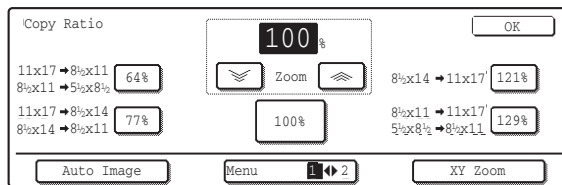

● Menu 2

- Enlargement keys (2 to 4 ratios)  
200%, 400%, any ratios (max. of two)
- Reduction keys (2 to 4 ratios)  
25%, 50%, any ratios (max. of two)
- Full size key  
100%

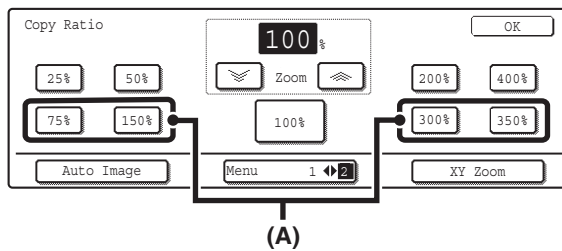

3



**Keys marked (A)**

The keys marked (A) can be set to show any ratio using "Add or Change Extra Preset Ratios" in the system settings (administrator).

Touch a preset ratio key and zoom key to select the desired ratio and touch the [OK] key.

After touching the [OK] key, make sure that a paper size suitable for the ratio is selected.

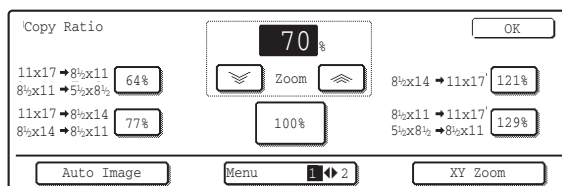

4



- To quickly select a ratio, touch a reduction or enlargement key to select a ratio close to the desired ratio and then use the zoom keys for fine adjustment.
- The zoom keys can be used to select any ratio from 25% to 400% in increments of 1%.
- Touch the key to increase the ratio, or the key to decrease the ratio. (If you continue to touch the key, the ratio will change automatically. After 3 seconds, the ratio will change rapidly.)
- If the message "Image is larger than the copy paper." appears when an enlargement ratio is selected, the image may not fit on the paper.

Touch the [Job Detail Settings] key and make sure that a suitable paper size is selected for the ratio.

If "Auto" appears in the [Paper Select] key (B), auto paper selection is enabled. If auto paper selection is not enabled, select the paper size manually.

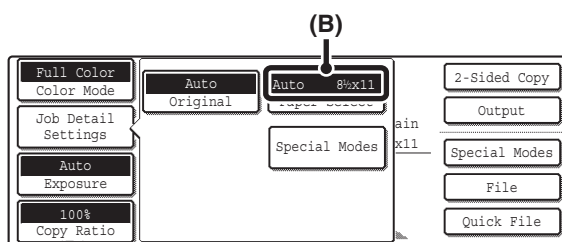

5

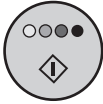

or



Press the [COLOR START] key (○●●●) or the [BLACK & WHITE START] key (○●).

Scanning begins.

- If the originals were placed in the document feeder tray, the originals are copied.
- If you placed the original on the document glass, scan each page one page at a time. If you are using the sort function or other function that requires all originals to be scanned before the copies are printed, you must use the same [START] key that you used to scan the first original to scan each of the remaining originals.



**To cancel scanning of the original and copying...**

Press the [STOP] key (⊘).



**To return the ratio to 100%...**

To return the ratio setting to 100%, touch the [Copy Ratio] key to display the ratio menu and then touch the [100%] key.



**System Settings (Administrator): Add or Change Extra Preset Ratios**

Two enlargement preset ratios (101% to 400%) and two reduction preset ratios (25% to 99%) can be added. An added preset ratio can also be changed.

# ENLARGING/REDUCING THE LENGTH AND WIDTH SEPARATELY (XY Zoom)

The XY Zoom feature allows the horizontal and vertical copy ratios to be changed separately. Both the horizontal and vertical ratios can be set from 25% to 400% in increments of 1%.

**When 50% is selected for the horizontal ratio and 70% is selected for the vertical ratio**

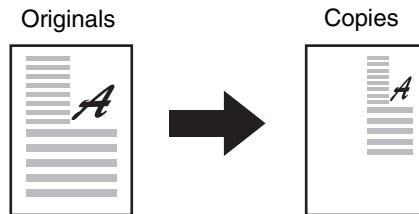

1

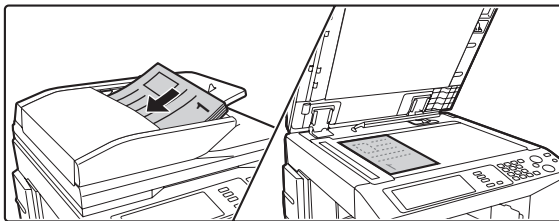

## Place the original.

Place the original face up in the document feeder tray, or face down on the document glass.

2

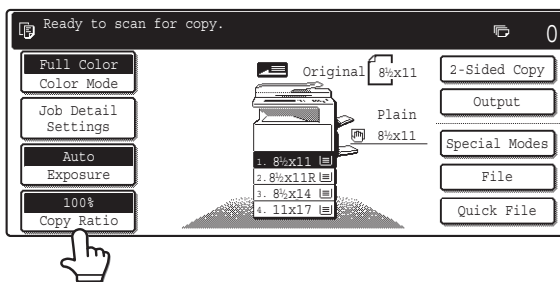

## Touch the [Copy Ratio] key.

3

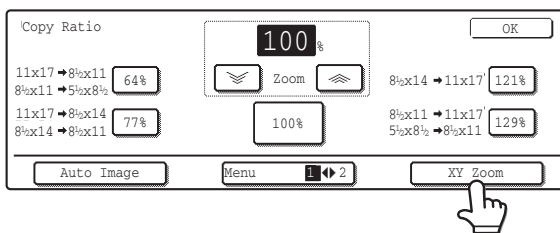

## Touch the [XY Zoom] key.

4

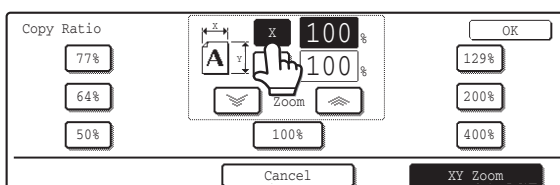

## Touch the [X] key.

The initial state of the [X] key is selected (highlighted), so this step is normally not necessary. Touch the [X] key only if it is not highlighted.

5

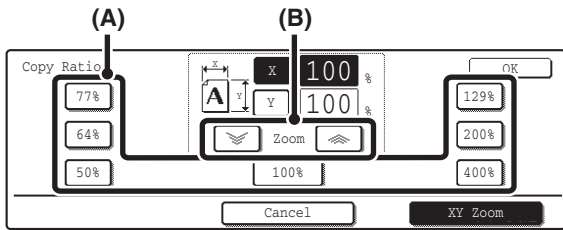

**Touch one of the preset ratio keys (A) and the zoom keys (B) to set the horizontal (X) ratio.**

- (A) A preset ratio key will not become highlighted when touched.
- (B) The zoom keys can be touched to set the ratio from 25% to 400% in increments of 1%.



To quickly select a ratio, touch a preset ratio key (A) to select a ratio close to the desired ratio and then use the zoom keys (B) for fine adjustment.

6

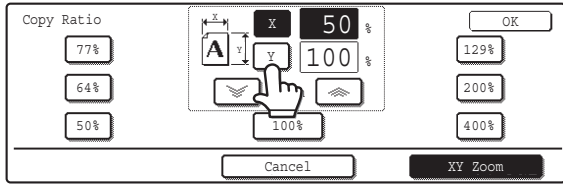

**Touch the [Y] key.**

7

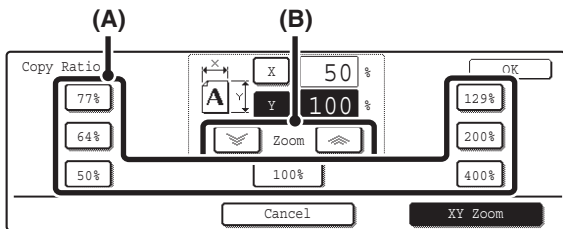

**Touch one of the preset ratio keys (A) and the zoom keys (B) to set the vertical (Y) ratio.**

- (A) A preset ratio key will not become highlighted when touched.
- (B) The zoom keys can be touched to set the ratio from 25% to 400% in increments of 1%.



If needed, you can touch the [X] key once again to readjust the X zoom.

8

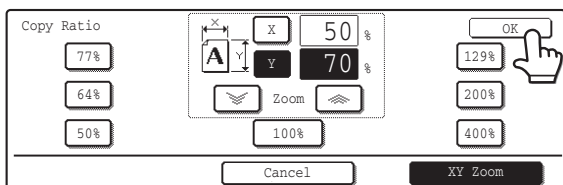

**Touch the [OK] key.**

9

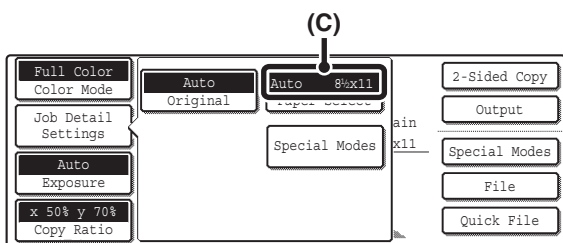

**Touch the [Job Detail Settings] key and make sure that a suitable paper size is selected for the ratio.**

If "Auto" appears in the [Paper Select] key (C), auto paper selection is enabled. If auto paper selection is not enabled, select the paper size manually.



or



Press the [COLOR START] key (○●●●) or the [BLACK & WHITE START] key (○●).

Scanning begins.

- If the originals were placed in the document feeder tray, the originals are copied.
- If you placed the original on the document glass, scan each page one page at a time. If you are using the sort function or other function that requires all originals to be scanned before the copies are printed, you must use the same [START] key that you used to scan the first original to scan each of the remaining originals.



**To cancel scanning of the original and copying...**

Press the [STOP] key (⏏).



When the automatic document feeder is used, the vertical and horizontal ratio selection ranges are both 25% to 200%.



**To cancel an XY zoom setting...**

To cancel an XY Zoom setting, touch the [XY Zoom] key or the [Cancel] key.



# ORIGINAL SIZES

## CHECKING THE ORIGINAL SIZE

When the original is placed, the original size is automatically detected and displayed in the base screen. If [Auto] appears in the [Original] key that is displayed when the [Job Detail Settings] key is touched, the size of the placed original is automatically detected. (Automatic original detection function)

### Example of base screen

The original size is displayed. An icon shows the orientation of the original.

If the original size is not a standard size, it will not be automatically detected. In this case, specify the original size.

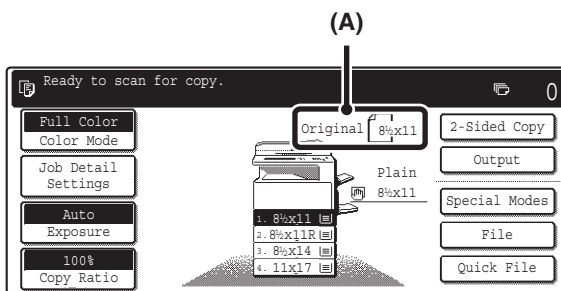

### Example of the [Original] key display

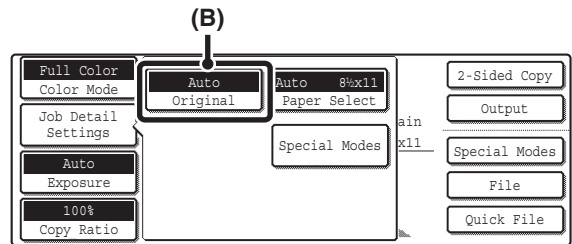

(A) The original size is displayed.

(B) "Auto" appears when the automatic original detection function is operating.

## List of original size detector settings

The standard sizes are set in "Original Size Detector Setting" in the system settings (administrator). The factory default setting is "Inch-1".

Selections	Detectable original sizes	
	Document glass	Document feeder tray (automatic document feeder)
Inch-1	11" x 17", 8-1/2" x 14", 8-1/2" x 11", 8-1/2" x 11"R, 5-1/2" x 8-1/2"	11" x 17", 8-1/2" x 14", 8-1/2" x 11", 8-1/2" x 11"R, 5-1/2" x 8-1/2", A4, A3
Inch-2	11" x 17", 8-1/2" x 13", 8-1/2" x 11", 8-1/2" x 11"R, 5-1/2" x 8-1/2"	11" x 17", 8-1/2" x 13", 8-1/2" x 11", 8-1/2" x 11"R, 5-1/2" x 8-1/2", A4, A3
AB-1	A3, A4, A4R, A5, B4, B5, B5R	A3, A4, A4R, A5, B4, B5, B5R, 8-1/2" x 11", 8-1/2" x 14", 11" x 17", 216 mm x 330 mm
AB-2	A3, A4, A4R, A5, B5, B5R, 216 mm x 330 mm	A3, A4, A4R, A5, B4, B5, B5R, 8-1/2" x 11", 11" x 17", 216 mm x 330 mm
AB-3	A4, A4R, A5, B4, 8K, 16K, 16KR	A3, A4, A4R, A5, B4, 8K, 16K, 16KR, 8-1/2" x 11", 11" x 17", 216 mm x 330 mm

- When the automatic original detection function is operating and the original is a non-standard size (an AB size or special size), the closest standard size may be displayed or the original size may not appear. In this event, manually set the correct original size. [SPECIFYING THE ORIGINAL SIZE](#) (page 35)
- When placing a non-standard size original on the document glass, you can make it easier for the size to be detected by placing a blank sheet of 8-1/2" x 11", 5-1/2" x 8-1/2" (A4, B5), or other standard size of paper on top of the original.

## Standard original placement orientations

Place originals in the document feeder tray or on the document glass so that the top and bottom of the original are oriented as shown below. If originals are placed in the wrong orientation, staples will be incorrectly positioned and some special features may not give the expected result. For more information on placing the original, see "3. ORIGINAL" in the User's Guide.

### [Example 1]

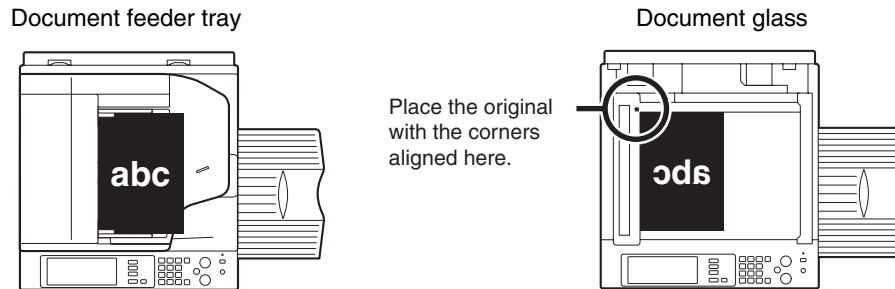

### [Example 2]

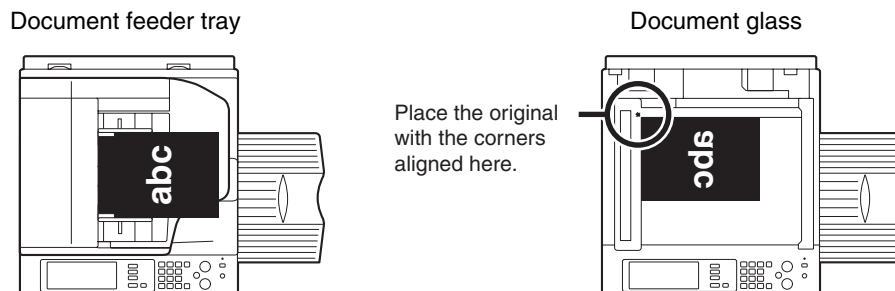

## Automatic copy image rotation (Rotation Copy)

If the orientation of the original and paper are different, the original image will be automatically rotated 90° to match the paper. (When an image is rotated, a message will be displayed.)

### [Example]

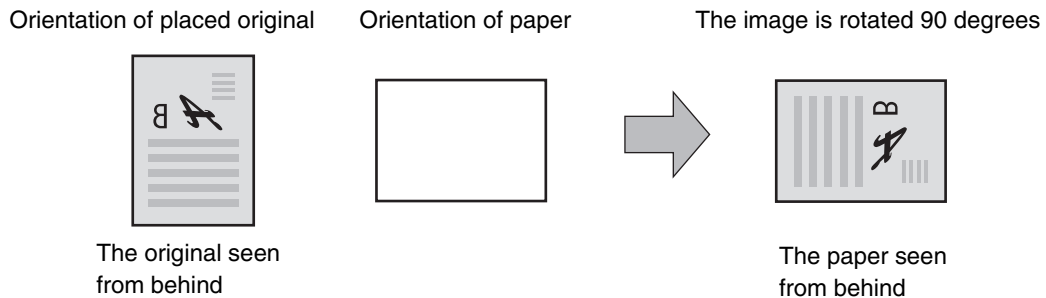

This function operates in either auto paper selection mode or auto image mode. Rotation can be disabled using "Rotation Copy Setting" in the system settings (administrator).

# SPECIFYING THE ORIGINAL SIZE

When the original size is a non-standard size or is not detected correctly, manually specify the original size.

**1**

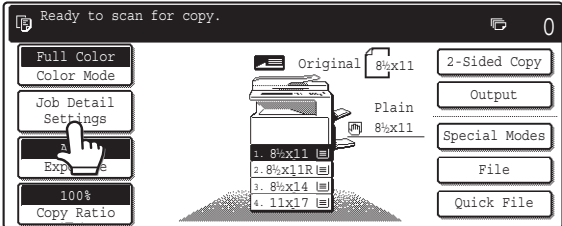

The screenshot shows the 'Ready to scan for copy.' interface. On the left, a vertical menu contains 'Full Color Color Mode', 'Job Detail Settings', 'Exposure', and '100% Copy Ratio'. 'Job Detail Settings' is highlighted with a hand icon. In the center, there is a printer icon and a list of original sizes: '1. 8½x11', '2. 8½x11R', '3. 8½x14', and '4. 11x17'. On the right, there are buttons for '2-Sided Copy', 'Output', 'Special Modes', 'File', and 'Quick File'.

**Touch the [Job Detail Settings] key.**

**2**

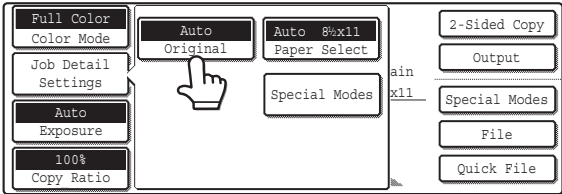

The screenshot shows the 'Job Detail Settings' menu. The 'Original' option is highlighted with a hand icon. Other options include 'Auto Original', 'Auto 8½x11 Paper Select', 'Special Modes', '2-Sided Copy', 'Output', 'Special Modes', 'File', and 'Quick File'.

**Touch the [Original] key.**

**3**

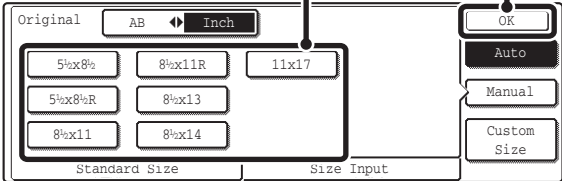

The screenshot shows the 'Original' size selection menu. The 'Original' header has 'AB' and 'Inch' with a double-headed arrow between them. Below are two columns of size keys: 'Standard Size' (5½x8½, 5½x8½R, 8½x11, 8½x11R, 8½x13, 8½x14) and 'Size Input' (11x17). On the right, there are buttons for 'OK', 'Auto', 'Manual', and 'Custom Size'. Arrows point to the 'Inch' key (1) and the 'OK' key (2).

**Specify the original size.**

- Specifying an inch original size

- (1) Touch the appropriate original size key.
- (2) Touch the [OK] key.

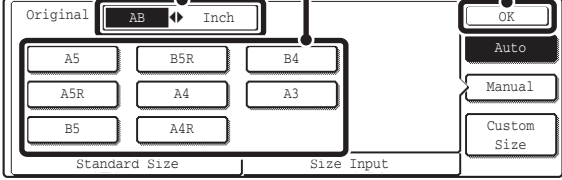

The screenshot shows the 'Original' size selection menu. The 'Original' header has 'AB' and 'Inch' with a double-headed arrow between them. Below are two columns of size keys: 'Standard Size' (A5, A5R, B5, B5R, A4, A4R, B4, A3) and 'Size Input'. On the right, there are buttons for 'OK', 'Auto', 'Manual', and 'Custom Size'. Arrows point to the 'AB' key (1), the 'A5' key (2), and the 'OK' key (3).

- Specifying an AB original size

- (1) Touch the [AB ↔ Inch] key.
- (2) Touch the appropriate original size key.
- (3) Touch the [OK] key.

● **Specifying a non-standard original size**

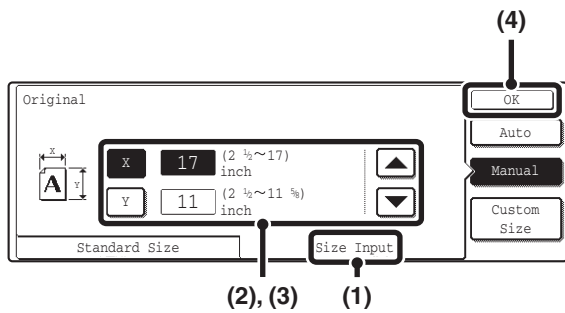

(1) **Touch the [Size Input] tab.**

(2) **Enter the X (horizontal) dimension of the original.**

With the [X] key highlighted, enter the X (horizontal) dimension of the original with the keys. When the document glass is used, a dimension from 2-1/2" to 17" (64 mm to 432 mm) can be entered.

When an automatic document feeder is installed, a dimension from 5-3/4" to 17" (143 mm to 432 mm) can be entered. If the length or width of the original is less than 5-3/4" (143 mm), use the document glass.

(3) **Enter the Y (vertical) dimension of the original.**

Touch the [Y] key and enter the Y (vertical) dimension of the original with the keys. When the document glass is used, a dimension from 2-1/2" to 11-5/8" (64 mm to 297 mm) can be entered.

When an automatic document feeder is installed, a dimension from 5-1/8" to 11-5/8" (131 mm to 297 mm) can be entered. If the length or width of the original is less than 5-1/8" (131 mm), use the document glass.

(4) **Touch the [OK] key.**

**Verify that the correct original size is entered.**

- Make sure that the entered numbers appear in the [Original] key. If the numbers are not correct, touch the [Original] key again and enter the correct numbers.
- If the correct numbers appear, touch the [Job Detail Settings] key to return to the base screen of copy mode. The original size display in the base screen will show "Manual".

4

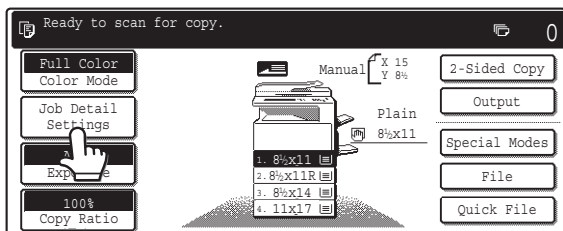

# STORING FREQUENTLY USED ORIGINAL SIZES

You can save special original sizes that you frequently use. This section explains how to store, call up, change, and delete special original sizes.

## Storing original sizes

Up to 9 special original sizes can be stored.

1

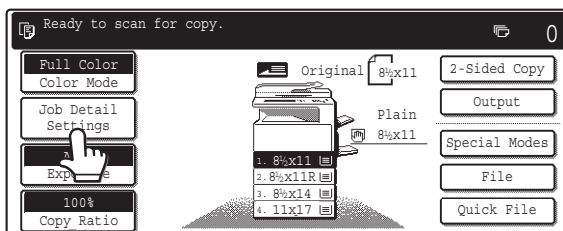

**Touch the [Job Detail Settings] key.**

2

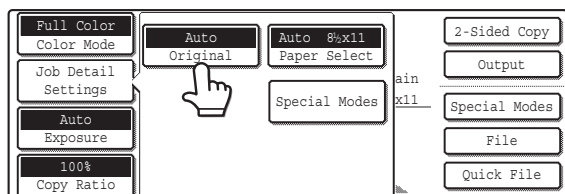

Touch the [Original] key.

3

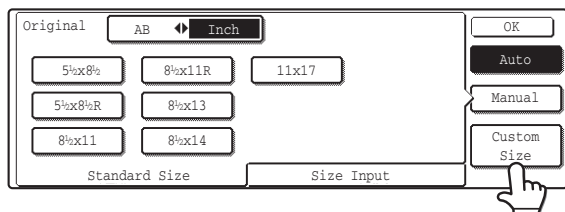

Touch the [Custom Size] key.

4

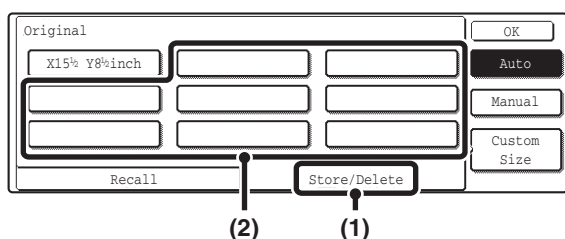

Select a key for storing a custom original size.

- (1) Touch the [Store/Delete] tab.
- (2) Touch a key for storing a custom original size.

Touch a key that does not show a size (  ).

5

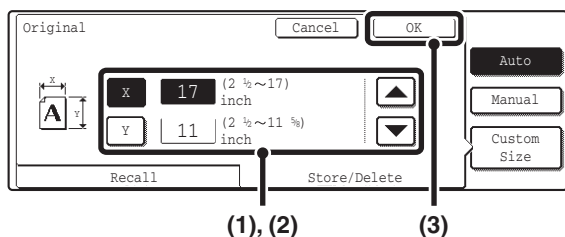

Enter the original size.

- (1) Enter the X (horizontal) dimension of the original.

With the [X] key highlighted, enter the X (horizontal) dimension of the original with the   keys. A dimension from 2-1/2" to 17" (64 mm to 432 mm) can be entered.

- (2) Enter the Y (vertical) dimension of the original.

Touch the [Y] key and enter the Y (vertical) dimension of the original with the   keys. A dimension from 2-1/2 to 11-5/8" (64 mm to 297 mm) can be entered.

- (3) Touch the [OK] key.

6

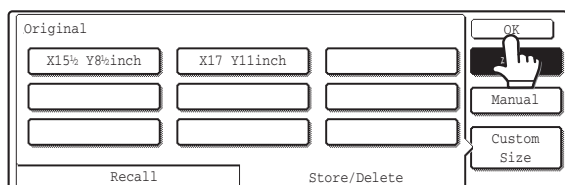

Touch the [OK] key.



The stored original size will be retained even if an interruption in the power supply occurs.



**To cancel the operation...**  
Press the [CLEAR ALL] key (  ).

# Using a stored original size

**1**

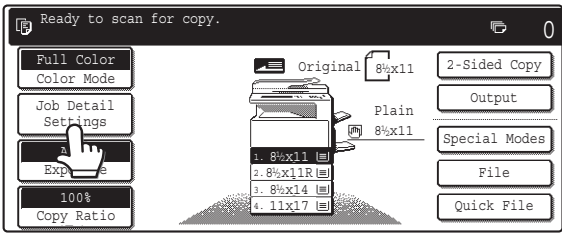

Ready to scan for copy.

Full Color Color Mode

Job Detail Settings

Exposure

100% Copy Ratio

Original 8½x11

Plain 8½x11

1. 8½x11

2. 8½x11R

3. 8½x14

4. 11x17

2-Sided Copy

Output

Special Modes

File

Quick File

Touch the [Job Detail Settings] key.

**2**

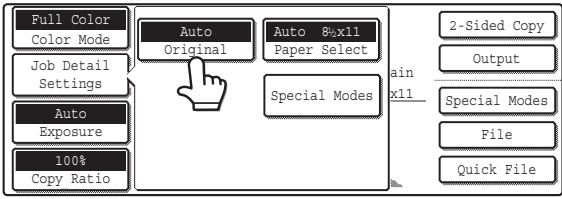

Full Color Color Mode

Job Detail Settings

Auto Exposure

100% Copy Ratio

Auto Original

Auto 8½x11 Paper Select

Special Modes

2-Sided Copy

Output

Special Modes

File

Quick File

Touch the [Original] key.

**3**

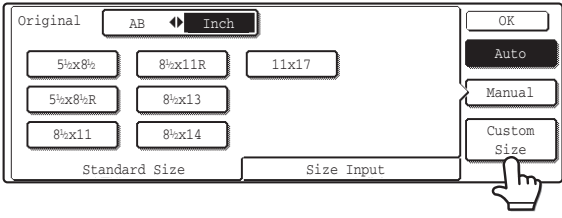

Original AB Inch

5½x8½

8½x11R

11x17

5½x8½R

8½x13

8½x11

8½x14

Standard Size

Size Input

OK

Auto

Manual

Custom Size

Touch the [Custom Size] key.

**4**

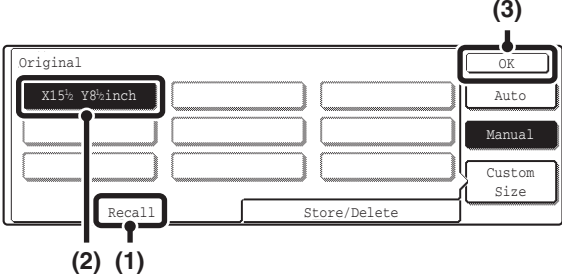

Original

X15½ Y8½inch

Recall

Store/Delete

OK

Auto

Manual

Custom Size

(1)

(2)

(3)

Call up the stored original size.

- (1) Touch the [Recall] tab.
- (2) Touch the key of the original size that you wish to call up.
- (3) Touch the [OK] key.



## To cancel the operation...

Press the [CLEAR ALL] key (CA).

# Changing a stored original size

**1**

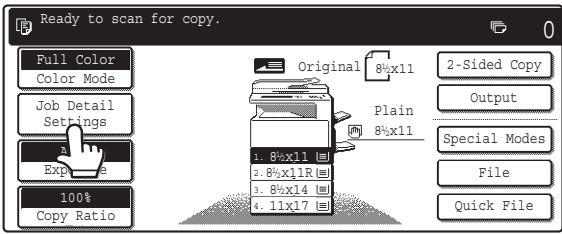

Ready to scan for copy.

Full Color Color Mode

Job Detail Settings

Exposure

100% Copy Ratio

Original 8½x11

Plain 8½x11

2-Sided Copy

Output

Special Modes

File

Quick File

1. 8½x11

2. 8½x11R

3. 8½x14

4. 11x17

Touch the [Job Detail Settings] key.

**2**

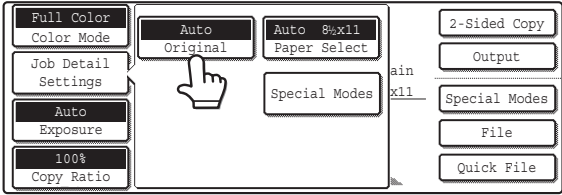

Full Color Color Mode

Job Detail Settings

Auto Exposure

100% Copy Ratio

Auto Original

Auto 8½x11 Paper Select

Special Modes

2-Sided Copy

Output

Special Modes

File

Quick File

Touch the [Original] key.

**3**

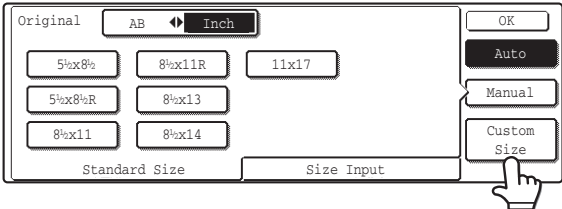

Original AB Inch

5½x8½

8½x11R

11x17

5½x8½R

8½x13

8½x11

8½x14

Standard Size

Size Input

OK

Auto

Manual

Custom Size

Touch the [Custom Size] key.

**4**

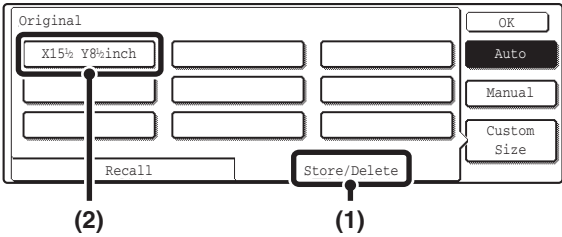

Original

X15% Y8%inch

Recall

Store/Delete

OK

Auto

Manual

Custom Size

(2)

(1)

Select the original size key that you wish to change.

- (1) Touch the [Store/Delete] tab.
- (2) Touch the original size key that you wish to change.

Touch the key ( X15% Y8%inch ) that shows the original size that you wish to change.

**5**



A custom size has already been stored in this location.

Cancel

Delete

Modify

Touch the [Modify] key.

6

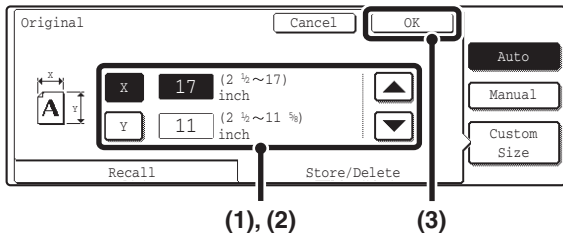

### Change the original size.

- (1) Enter the X (horizontal) dimension of the original.

With the [X] key highlighted, enter the X (horizontal) dimension of the original with the keys. A dimension from 2-1/2" to 17" (64 mm to 432 mm) can be entered.

- (2) Enter the Y (vertical) dimension of the original.

Touch the [Y] key and enter the Y (vertical) dimension of the original with the keys. A dimension from 2-1/2" to 11-5/8" (64 mm to 297 mm) can be entered.

- (3) Touch the [OK] key.

7

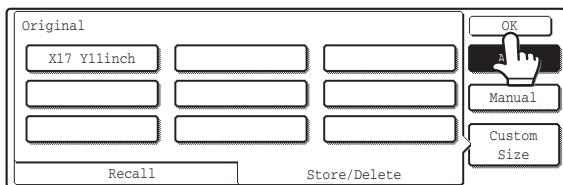

### Touch the [OK] key.



#### To cancel the operation...

Press the [CLEAR ALL] key ().



# Deleting a stored original size

**1**

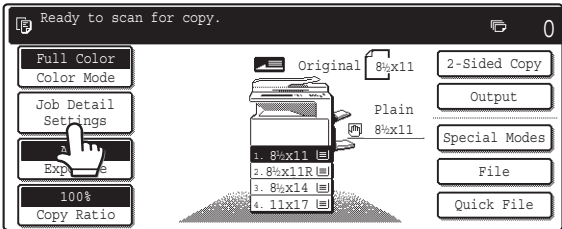

Ready to scan for copy.

Full Color  
Color Mode

Job Detail Settings

EXPOSURE

100%  
Copy Ratio

Original 8½x11

2-Sided Copy

Output

Plain 8½x11

Special Modes

File

Quick File

1. 8½x11

2. 8½x11R

3. 8½x14

4. 11x17

Touch the [Job Detail Settings] key.

**2**

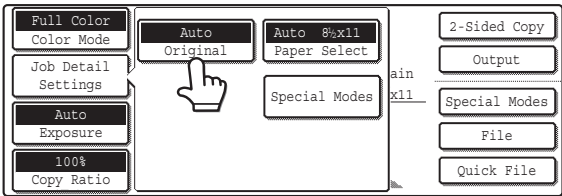

Full Color  
Color Mode

Auto Original

Auto 8½x11  
Paper Select

2-Sided Copy

Output

Job Detail Settings

Plain 8½x11

Special Modes

Special Modes

File

Quick File

Auto Exposure

100%  
Copy Ratio

Touch the [Original] key.

**3**

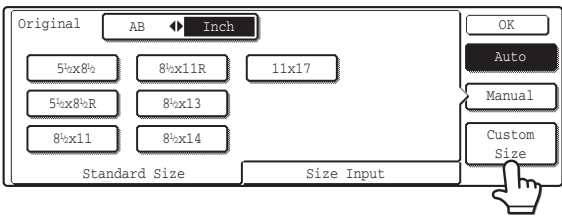

Original AB Inch

OK

Auto

Manual

Custom Size

5½x8½

8½x11R

11x17

5½x8½R

8½x13

8½x11

8½x14

Standard Size

Size Input

Touch the [Custom Size] key.

**4**

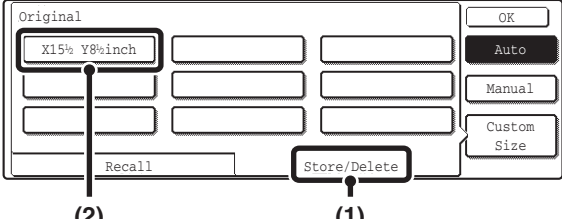

Original

OK

Auto

Manual

Custom Size

Recall

Store/Delete

X15½ Y8½inch

(2)

(1)

Select the original size key that you wish to delete.

- (1) Touch the [Store/Delete] tab.
- (2) Touch the original size key that you wish to delete.

Touch the key ( X15½ Y8½inch ) that shows the original size that you wish to delete.

**5**



A custom size has already been stored in this location.

Cancel

Delete

Modify

Touch the [Delete] key.

**6**

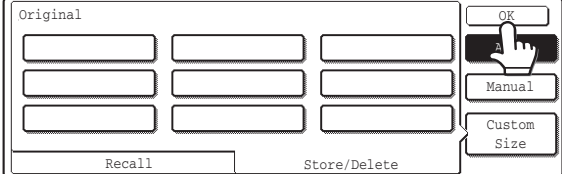

Original

OK

Manual

Custom Size

Recall

Store/Delete

Touch the [OK] key.

 To cancel the operation...  
Press the [CLEAR ALL] key ( CA ).

# OUTPUT

To select output functions and the output tray, touch the [Output] key in the base screen of copy mode. Output functions that can be selected are sort, group, offset, staple sort, saddle stitch, and punch. All settings are explained in this section based on the assumption that a saddle stitch finisher, punch module and right tray are installed.

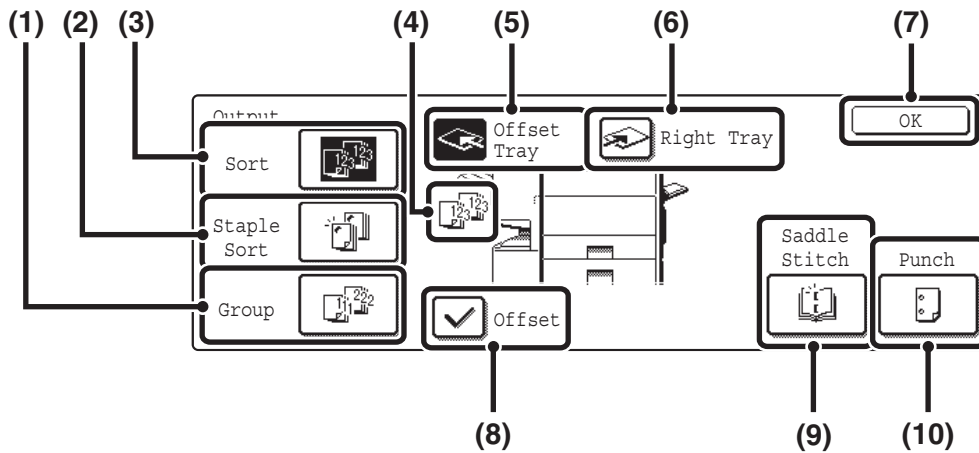

- (1) **[Group] key**  
This is used to group copies by page.  
➤ [Group mode](#) (page 43)
- (2) **[Staple Sort] key**  
This is used to sort the output into sets, staple each set, and deliver the sets to the tray. (Note that the sets will not be offset in the output tray.) When this function is selected, three keys will appear for selecting the staple position.  
➤ [Staple sort function / Saddle stitch function](#) (page 44)
- (3) **[Sort] key**  
This is used to sort (collate) output into sets.  
➤ [Sort mode](#) (page 43)
- (4) **Output display**  
An icon will appear to indicate the output mode.
- (5) **[Offset Tray] key ([Center Tray] key\*)**  
This is used to offset each set of output from the previous set in the offset tray (center tray). The [Offset Tray] key is automatically selected when the [Staple Sort] key is selected.  
\* When only a right tray is installed, this appears as the "Center tray".
- (6) **[Right Tray] key**  
Select this key to have output delivered to the right tray. When the right tray is selected, offset, staple sort, saddle stitch, and punch cannot be selected.
- (7) **[OK] key**  
Touch this key to close the output screen and return to the base screen.
- (8) **[Offset] key**  
This is used to offset each set of output from the previous set. The offset function operates when the checkbox is selected  and does not operate when the checkbox is not selected . (The offset checkmark is automatically cleared when the staple sort function is selected.)  
➤ [Offset function](#) (page 43)
- (9) **[Saddle Stitch] key**  
This is used to staple and fold each set of copies at the centerline.  
➤ [Staple sort function / Saddle stitch function](#) (page 44)  
When this key is touched, the saddle stitch setting screen appears. (Only when "Automatic Saddle Stitch" is enabled in the system settings (administrator).)
- (10) **[Punch] key**  
This is used to punch holes in the output.  
➤ [Punch function](#) (page 45)

The keys that appear and that can be selected will vary depending on what peripheral devices are installed. Depending on what peripheral devices are installed, it may not be possible to select certain keys. If your screen is different from the above screen, see the screens below.

### Display example 1

The screen when a right tray, finisher, and saddle finisher are not installed.



### Display example 2

The screen when a right tray is installed.

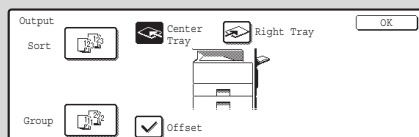

### Display example 3

The screen when a right tray, finisher and punch module are installed.



# OUTPUT MODES

This section explains the output functions.

## Sort mode

This is used to sort (collate) output into sets.

**Example: Sorting the originals into 5 sets**

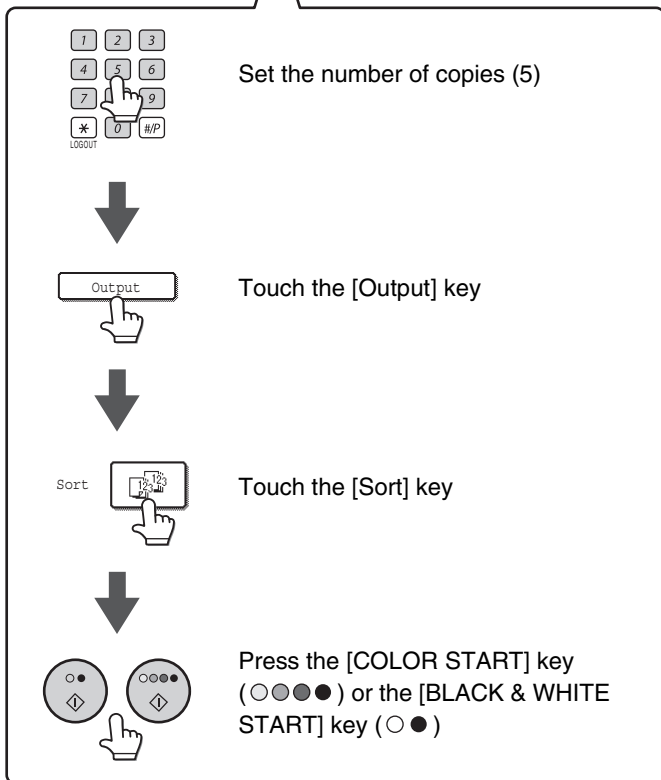
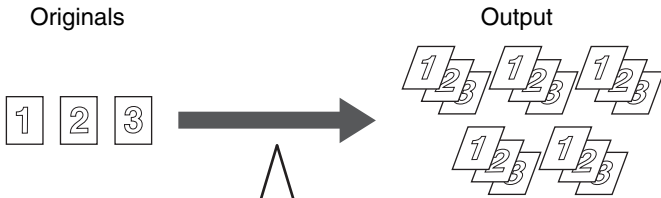



-  • The sort function is automatically selected when originals are placed in the automatic document feeder.
- When the Quick File Folder for document filing is full, copying of a large number of originals using the sort function will be affected. Delete unneeded files from the Quick File Folder.

## Group mode

This function groups copies by page.

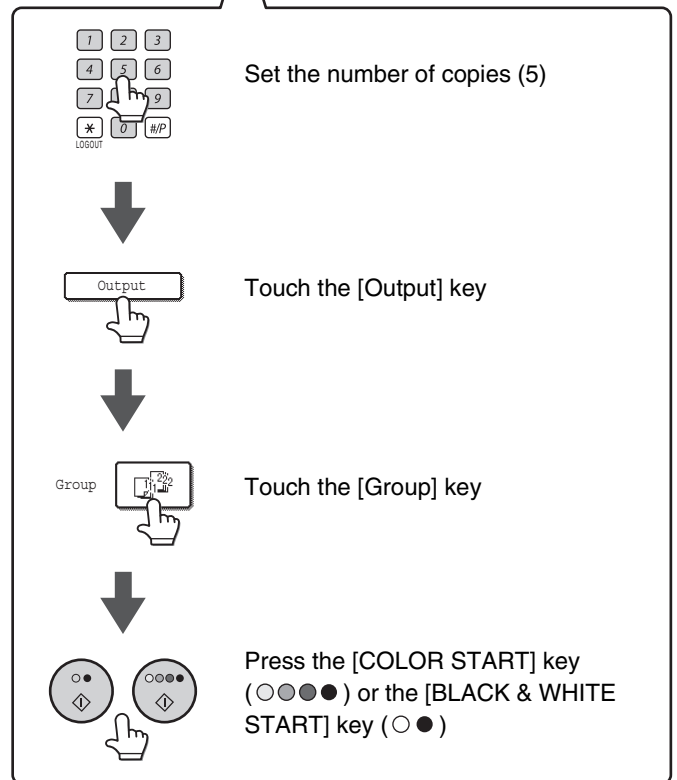
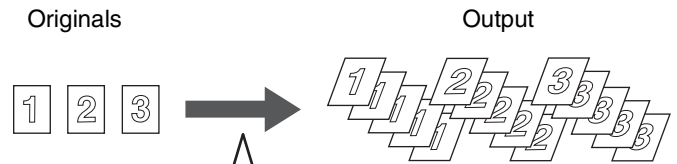
**Example: Groups of 5 copies of each page**



-  • The group function is automatically selected when an original is placed on the document glass.

## Offset function

This function offsets each set of copies from the previous set in the output tray, making it easy to separate sets of copies.

Offset function "ON"

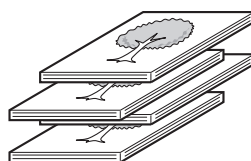

Offset function "OFF"

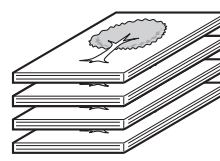

-  • The offset function cannot be used in the right tray.
- The offset function cannot be selected when the staple sort function is selected.









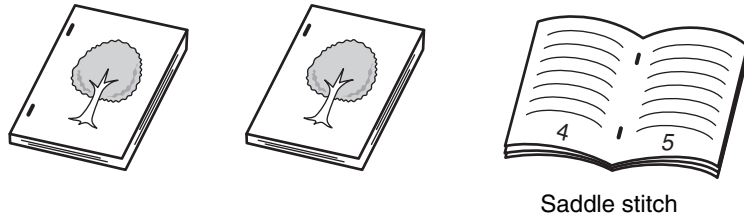

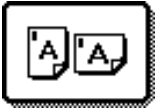
## Staple sort function / Saddle stitch function

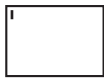
The staple sort function sorts output into sets, staples each set, and delivers the sets to the tray. The saddle stitch function staples each set in 2 places at the centerline and folds the stapled set.

The relations between the stapling positions, paper orientation, permitted paper sizes for stapling, and number of sheets that can be stapled are shown below.

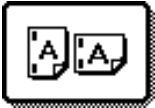
For original placement orientations, see "[Original placement orientation \(for the staple sort and punch functions\)](#)" (page 45).

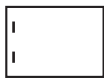

Stapling positions	Vertically-oriented paper		Horizontally-oriented paper	
1 staple at top left corner 		<b>Applicable paper sizes</b> 8-1/2" x 11", A4, B5, 16K <b>Number of sheets that can be stapled:</b> Max. 50 sheets* • Saddle stitch finisher Max. 30 sheets* • Finisher Max. 50 sheets*		<b>Applicable paper sizes</b> 11" x 17", 8-1/2" x 14", 8-1/2" x 13", 8-1/2" x 11"R, A3, B4, A4R, 8K, 16KR <b>Number of sheets that can be stapled:</b> 11" x 17", 8-1/2" x 14", 8-1/2" x 13" A3, B4, 8K: Max. 30 sheets* 8-1/2" x 11"R, A4R, 16KR: • Saddle stitch finisher Max. 30 sheets* • Finisher Max. 50 sheets*
1 staple at bottom left corner 				
2 staples at left edge 				
Saddle stitch (only with saddle stitch finisher) 			Saddle stitch cannot be used when the paper is oriented vertically	

\* Two 56 lbs. (209 g/m<sup>2</sup>) sheets can be inserted as covers and stapled (only 1 sheet when saddle stitch is used). When this is done, the number of sheets that can be used is two less (one less for saddle stitch) than the stated maximum.

-  When Mixed Size Original in the special modes is used with the "Same Width" setting, the maximum number of sheets that can be stapled is 25 regardless of the paper size.
- The saddle stitch function can only be used when a saddle stitch finisher is installed.

## Punch function

If an optional punch module is installed, holes can be punched in output.

Paper that can be punched is 11" x 17" to 8-1/2" x 11" (16 lbs. to 56 lbs.) (A3 to B5R (60 g/m<sup>2</sup> to 209 g/m<sup>2</sup>)). 12" x 18" (A3W) sized paper, transparency film and other special types of paper cannot be used.

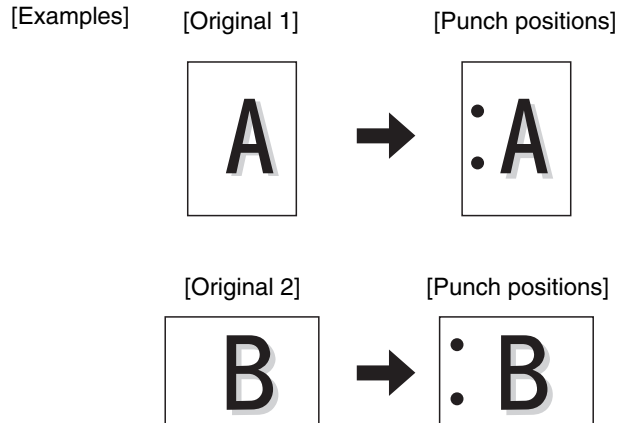

The saddle stitch and hole punch functions cannot be selected at the same time.

## Original placement orientation (for the staple sort and punch functions)

When using the staple sort function or the punch function, the original must be placed as shown below to enable stapling or punching in the desired position on the paper.

Staple sort		Punch	
Document feeder tray	Document glass	Document feeder tray	Document glass
		/	

# MAKING COPIES USING THE BYPASS TRAY (Copying on special papers)

In addition to plain paper, the bypass tray allows you to make copies on transparency film, postcards, tab paper, and other special papers.

For detailed information on paper that can be loaded in the bypass tray, see the Safety Guide. For precautions and other important information when loading paper in the bypass tray, see "LOADING PAPER IN THE BYPASS TRAY" in the User's Guide.

1

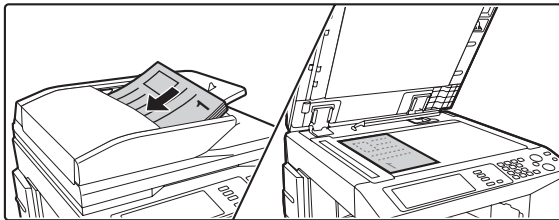

## Place the original.

Place the original face up in the document feeder tray, or face down on the document glass.

2

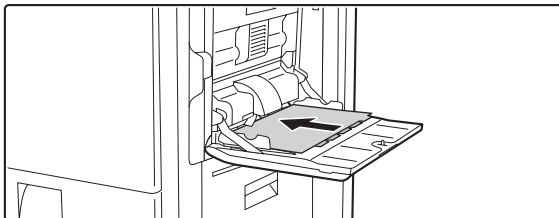

## Place paper in the bypass tray.

Insert the paper with print side face down.

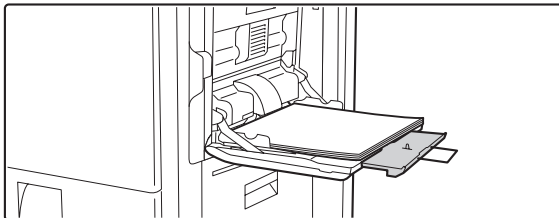

When loading paper larger than 8-1/2" x 11"R or A4R, be sure to pull out the bypass tray extension. Pull the bypass tray extension all the way out. If the bypass tray extension is not pulled all the way out, the size of the loaded paper will not be correctly displayed.

3

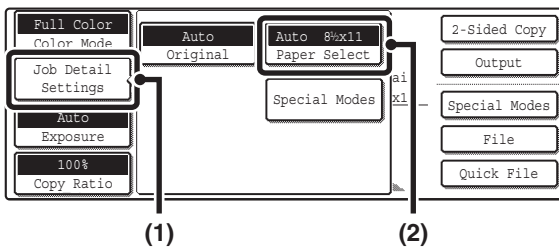

## Open the paper settings screen.

- (1) Touch the [Job Detail Settings] key.
- (2) Touch the [Paper Select] key.

4

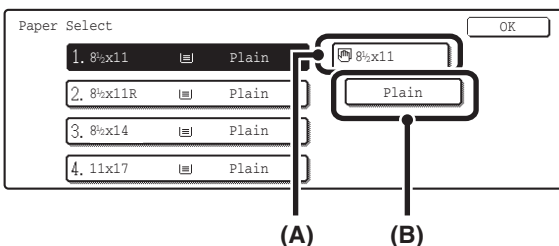

## Set the type and size of paper loaded in the bypass tray.

- (A) Shows the size of paper loaded in the bypass tray.
- (B) The currently selected paper type will be displayed.

If you wish to use the paper size and paper type shown in (A) and (B), touch (A) and touch the [OK] key. Go to step 8. To change the paper size or paper type, touch (B) and go to the next step.

5

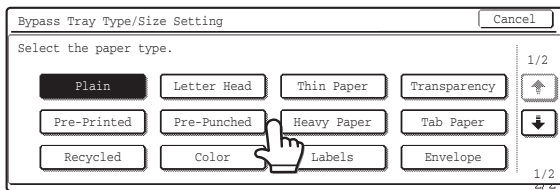

## Select the type of paper used in the bypass tray.

Select the paper type used.

6

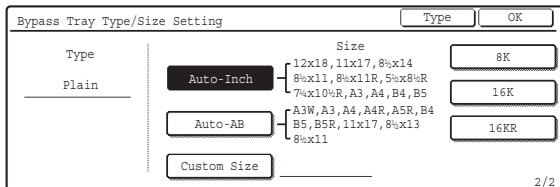

## Set the paper size.

Touch the [Auto-Inch] key, the [Auto-AB] key, or the [Custom Size] key. To use a paper size used in China, touch [8K], [16K], or [16KR]. After selecting the setting, touch the [OK] key.

### [Auto-Inch] key

Touch this key when the loaded paper is an inch size (8-1/2" x 11", etc.). When the paper placed in the bypass tray is an inch size, the paper size will be detected automatically and an appropriate size set.

### [Auto-AB] key

Touch this key when the loaded paper is an AB size (A4, etc.). When the paper inserted in the bypass tray is an AB size, the paper size will be detected automatically and an appropriate size set.

### [Custom Size] key

Touch this key when you know the size of the inserted paper but it is not one of the inch or AB sizes.

When the key is touched, the paper size entry screen appears. To set a paper size in inches, touch the [Inch] tab.

To set a paper size in millimeters, touch the [AB] tab.

Touch the [X] key and enter the horizontal dimension of the paper with the  $\downarrow$   $\uparrow$  keys, and then touch the [Y] key and enter the vertical dimension. When finished, touch the [OK] key.

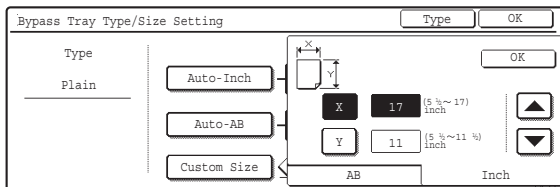

7

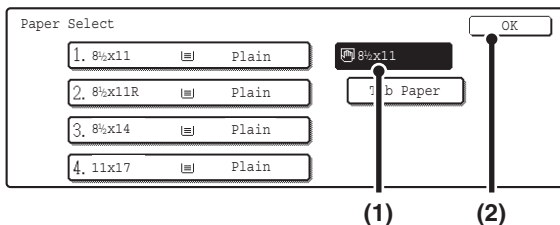

## Select the bypass tray.

(1) Touch the paper size key of the bypass tray.

(2) Touch the [OK] key.

When the [OK] key is touched, you will return to the job detail setting screen. Touch the [Job Detail Setting] key to return to the base screen of copy mode.

8

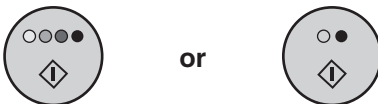

## Press the [COLOR START] key (○●●●) or the [BLACK & WHITE START] key (○●).

Scanning begins.

- If the originals were placed in the document feeder tray, the originals are copied.
- If you placed the original on the document glass, scan each page one page at a time. If you are using the sort function or other function that requires all originals to be scanned before the copies are printed, you must use the same [START] key that you used to scan the first original to scan each of the remaining originals.



To cancel scanning of the original and copying...

Press the [STOP] key (◀).

# INTERRUPTING A COPY RUN (Interrupt copy)

When you need to make an urgent copy and the machine is busy with a long copy run or other job, use interrupt copy. Interrupt copy temporarily stops the job in progress and lets you perform the interrupt copy job.

1

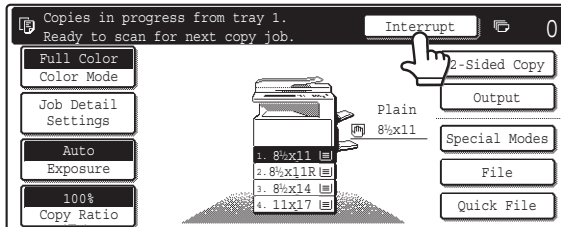

Touch the [Interrupt] key.

2

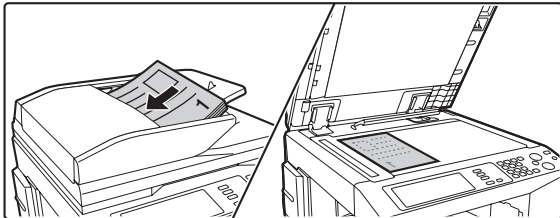

Place the original.

Place the original face up in the document feeder tray, or face down on the document glass.

3

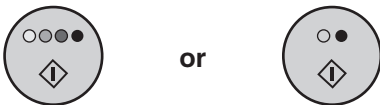

Select copy settings for the interrupt copy job and start copying.

The interrupt copy job begins.

4

 To cancel scanning of the original and copying...  
Press the [STOP] key (.

After the interrupt copy job is printed, the job that was interrupted resumes.

- If user authentication is enabled, the login screen will appear when the [Interrupt] key is pressed. Enter your user name and password to log in. The number of copies made will be added to the count of the user that logged in.
- Depending on the settings of the job in progress, the [Interrupt] key may not appear.
- Depending on the settings of the job in progress, the [Reserve] key may appear instead of the [Interrupt] key. Unlike interrupt copy, reserve copy does not temporarily stop the job in progress. Instead, the reserve copy job begins when the job in progress is finished.
- If the document glass is used for an interrupt copy job, 2-sided copying, sort copying, and staple sort copying cannot be selected. If any of these functions are necessary, use the automatic document feeder.



# JOB STATUS SCREEN

The job status screen is displayed when the [JOB STATUS] key on the operation panel is pressed. The job status screen shows the status of jobs by mode. When the [JOB STATUS] key is pressed, the job status screen of the mode that was being used before the key was pressed appears.

**Example: Pressing the key in copy mode**

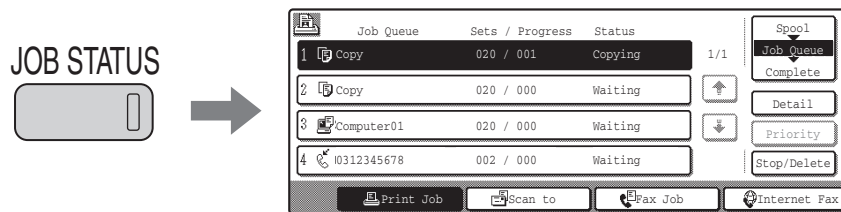

The left edge of the job status screen appears at the left edge of the touch panel screen. The left edge of the job status screen can be touched to display the job status screen.

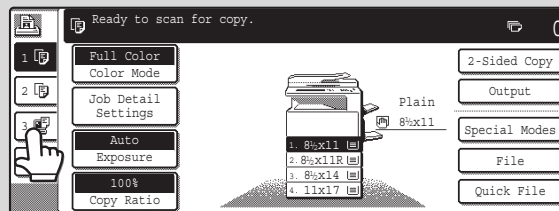

# JOB QUEUE SCREEN AND COMPLETED JOB SCREEN

The job status screen consists of the job queue screen that shows copy and print jobs waiting to be printed and the job currently in progress, the completed job screen that shows jobs that have been completed, and the spool screen that shows print jobs that have been spooled and encrypted PDF jobs that are waiting to be printed. This section explains the job queue screen and the completed jobs screen, which are related to copy mode. The job status screen switches between the job queue screen and the completed jobs screen each time the job status screen selector key is touched.

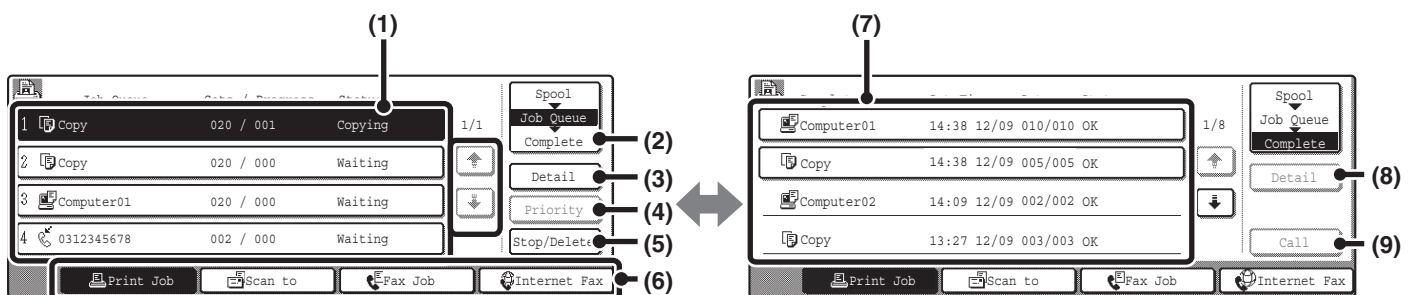

**(1) Job list (job queue screen)**

This shows the jobs that are waiting to be printed and the job in progress as keys (job keys). The jobs are printed in order from the job at the top of the queue. Each job key shows information on the job and the current status of the job.

**(2) Job status screen selector key**

Touch this key to switch through the job queue screen, the completed jobs screen, and the spool screen.

**(3) [Detail] key (job queue screen)**

Touch this key to display detailed information on a job.

**(4) [Priority] key**

Touch this key to give priority to a selected job.

**(5) [Stop/Delete] key**

Touch this key to stop or delete a selected job.

**(6) Mode switch keys**

Use these keys to select the mode that is shown in the job status screen.  
The status of copy jobs can be checked by touching the [Print Job] key.

**(7) Job list (completed jobs screen)**

This shows up to 99 completed jobs. The result (status) of each completed job is shown. Copy jobs that used the document filing function are indicated as keys.

**(8) [Detail] key (completed jobs screen)**

When a job is shown as a key in the job list, the [Detail] key can be touched to show detailed information on the job.

**(9) [Call] key**

Touch this key to call up and use a copy job stored using the document filing function.



For information on the spool screen, see the Printer Guide.

## Job key display

Each job key shows the position of the job in the job queue and the current status of the job.

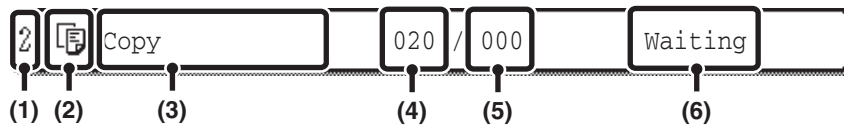

**(1) Indicates the number (position) of the job in the job queue.**

When the job currently being printed is finished, the job moves up 1 position in the job queue.

**(2) Mode icon**

The icon appears when the job is a copy job.

**(3) Job name**

"Copy" appears for a copy job.  
When user authentication is enabled, the name of the user that performed the job appears.

**(4) Number of copies (sets) entered**

This shows the number of copies (sets) specified.

**(5) Number of completed copies**

This shows the number of copies (sets) completed.  
"000" appears while the job is waiting in the job queue.

**(6) Job Status**

Shows the job status.

Message	Status
"Copying"	Copying is in progress.
"Waiting"	The job is waiting to be printed.
"Paper Empty"	The paper used for the job has run out. Add paper or change to a different paper tray.
"Error"	An error occurred while the job was being executed. Clear the error condition.

## Canceling a job that is waiting in the queue

To cancel a job that is waiting in the queue, touch the job key and then the [Stop/Delete] key. The following screen will appear. Touch the [Yes] key.

The job will be deleted from the queue.

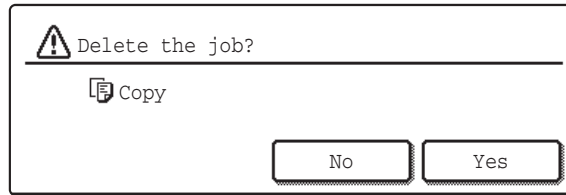

If the job in progress is a copy job, you can also press the [STOP] key (⏹) to display the above screen. To cancel, touch the [Yes] key.

## Giving priority to a job in the queue

If a copy job is performed when there are already multiple jobs in the queue, the copy job will appear at the end of the queue. However, if you have an urgent copy job, you can give priority to the job and have it executed first.

Touch the key of the urgent job and then touch the [Priority] key. The job will move to the top of the queue and copying will begin.

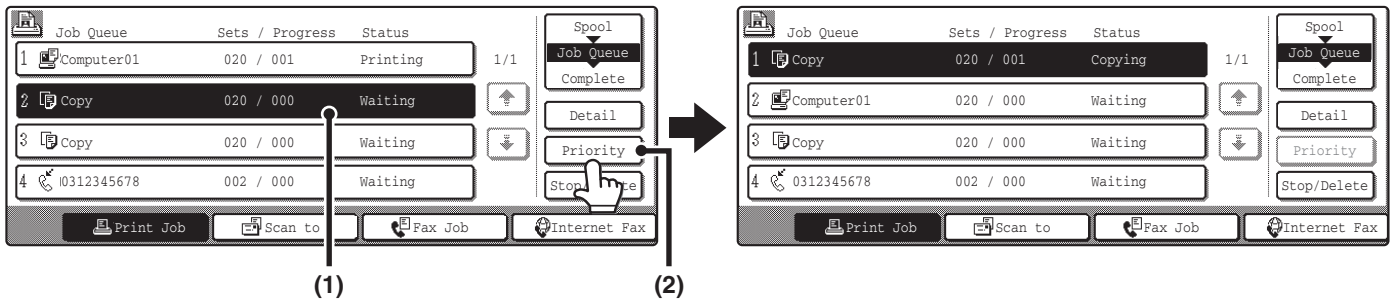

The job that was in progress will be moved to the second position in the queue and will wait. The job will resume when the priority job is finished.

## Checking information on a copy job waiting in the queue

Detailed information can be displayed on a copy job waiting in the queue.

Touch the key of the job that you wish to check and then touch the [Detail] key. The job information screen will appear.

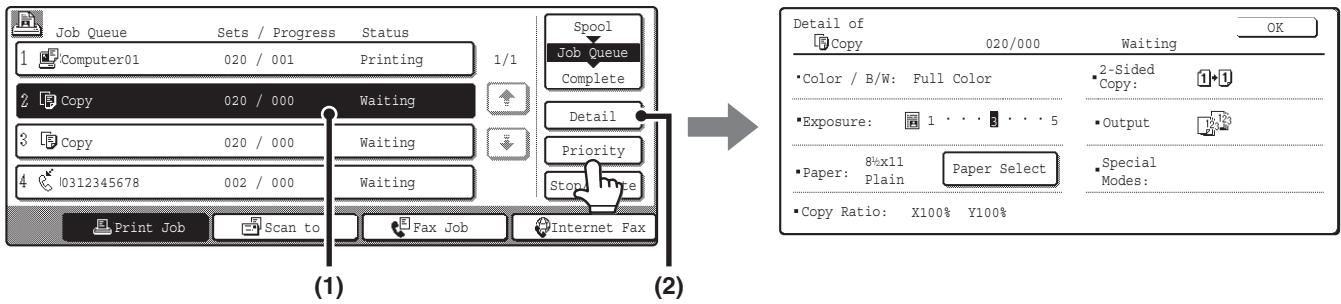

### [Paper Select] key

If a copy job is stopped because the paper ran out, the [Paper Select] key can be pressed to change to a different paper tray.

When the [Paper Select] key is pressed, the paper tray selection screen appears.

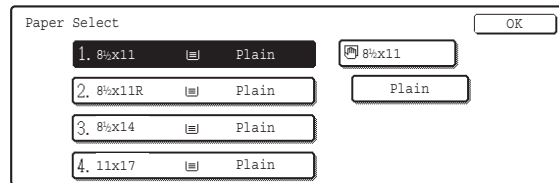

Touch the tray that has the size of paper that you wish to use and then touch the [OK] key. The stopped copy job will resume.

# WHEN THE DOCUMENT FILING FUNCTION IS USED

When a copy job has been saved using the [Quick File] key or [File] key of the document filing function, the job can be called up and reused from the job status screen.

Touch the job status screen selector key to display the completed jobs screen.

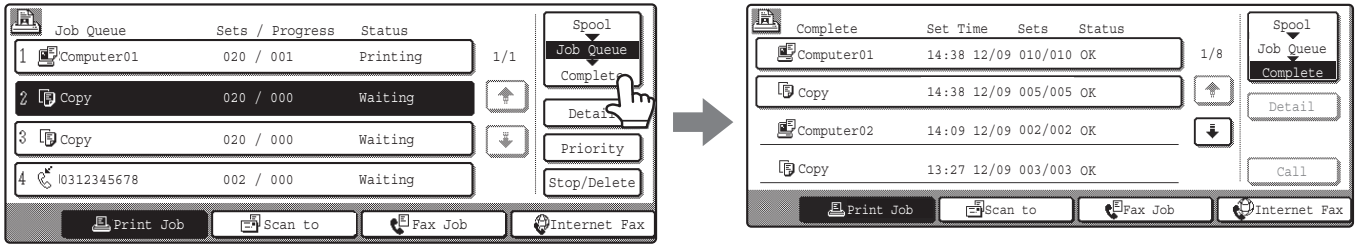

Copy jobs saved with the document filing function will appear as keys. To call up and reuse a job, touch the job key and then the [Call] key. The job selection screen of the document filing function will appear.

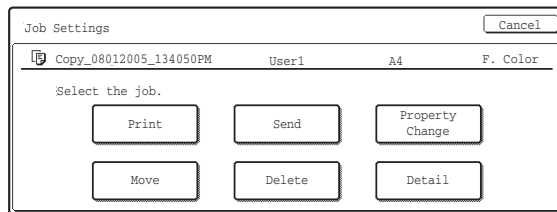

Manipulate the job from this screen. For more information on manipulating called up jobs, see the Document Filing Guide.



If you touch a key in the job list followed by the [Detail] key, the following screen will appear.

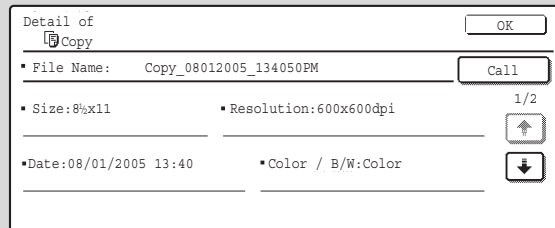

The [Call] key can be touched in this screen to open the job selection screen of the document filing function.

# 2

# CONVENIENT COPY FUNCTIONS

This chapter explains special-purpose functions, storing of copy settings, and other convenient functions.

## SPECIAL MODES

There are 2 ways to open the special modes screen from the base screen of copy mode.

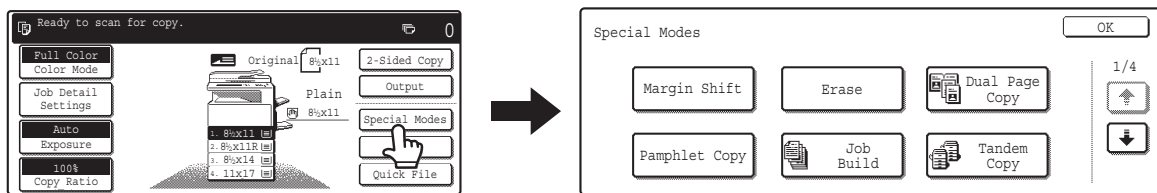

### 1. Touch the [Special Modes] key in the base screen of copy mode.

The explanations in this guide generally assume that this method is used.

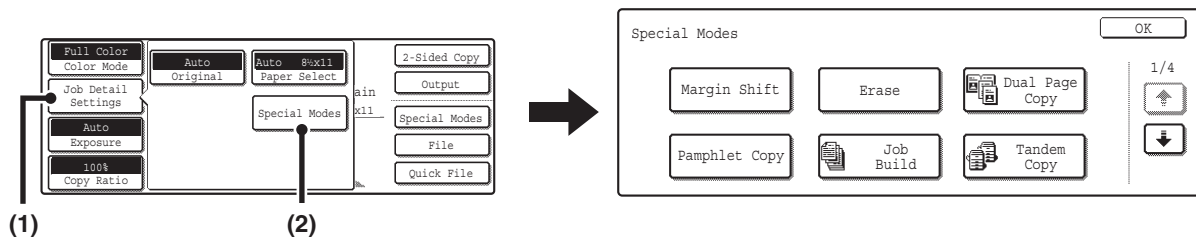

### 2. Touch the [Job Detail Settings] key in the base screen of copy mode and then touch the [Special Modes] key in the job detail settings screen.



Use either method to open the special modes screen. The same screen appears regardless of which method is used. The special modes screen consists of four screens. Use the   keys to switch through the screens.

## 1st screen

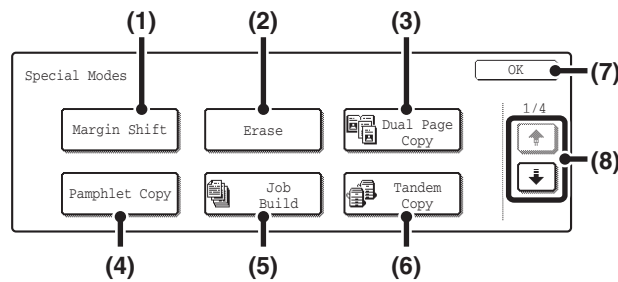

### (1) [Margin Shift] key

Use this to shift the image on the paper to create binding margins.

➤ [ADDING MARGINS \(Margin Shift\)](#) (page 59)

### (2) [Erase] key

This is used to erase peripheral shadows that occur when making copies of books and thick originals.

➤ [ERASING PERIPHERAL SHADOWS \(Erase\)](#) (page 61)

### (3) [Dual Page Copy] key

This is used to make separate copies of the left and right pages of a book or other bound document.

➤ [COPYING EACH FACING PAGE OF A BOUND DOCUMENT \(Dual Page Copy\)](#) (page 63)

### (4) [Pamphlet Copy] key

This is used to make pamphlet-style copies of 1-sided or 2-sided originals.

➤ [MAKING COPIES IN PAMPHLET FORMAT \(Pamphlet Copy\)](#) (page 65)

### (5) [Job Build] key

When you have a very large number of originals, this can be used to scan the originals in separate sets.

➤ [COPYING A LARGE NUMBER OF ORIGINALS AT ONCE \(Job Build\)](#) (page 69)

### (6) [Tandem Copy] key

Two machines connected to the same network can be used to run a large copy job in parallel.

➤ [USING TWO MACHINES TO COPY A LARGE NUMBER OF ORIGINALS \(Tandem Copy\)](#) (page 71)

### (7) [OK] key

Touch this to close the special modes screen.

### (8) [Up/Down] keys

Touch these to switch through the special modes screens.

## 2nd screen

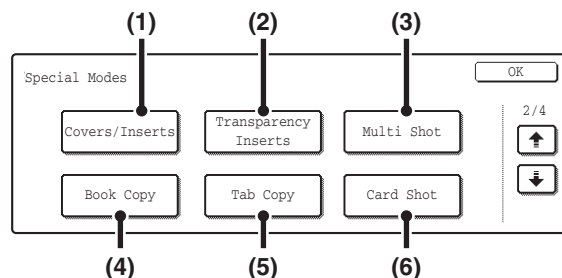

### (1) [Covers/Inserts] key

Front covers, back covers, and inserts can be added. The covers and inserts can be copied on.

➤ [USING A DIFFERENT PAPER TYPE FOR COVERS \(Covers/Inserts\)](#) (page 74)

### (2) [Transparency Inserts] key

Inserts can be automatically inserted between sheets of transparency film.

➤ [ADDING INSERTS WHEN COPYING ON TRANSPARENCY FILM \(Transparency Inserts\)](#) (page 85)

### (3) [Multi Shot] key

Multiple original pages can be copied onto a single sheet of paper in a uniform layout.

➤ [COPYING MULTIPLE PAGES ONTO ONE SHEET OF PAPER \(Multi Shot\)](#) (page 88)

### (4) [Book Copy] key

Books and other bound originals can be copied pamphlet style.

➤ [COPYING A PAMPHLET \(Book Copy\)](#) (page 91)

### (5) [Tab Copy] key

Use this to copy on the tabs of tab paper.

➤ [COPYING CAPTIONS ONTO TAB PAPER \(Tab Copy\)](#) (page 95)

### (6) [Card Shot] key

The front and reverse sides of a card can be copied onto one sheet of paper.

➤ [COPYING BOTH SIDES OF A CARD ON ONE SHEET OF PAPER \(Card Shot\)](#) (page 99)

## 3rd screen

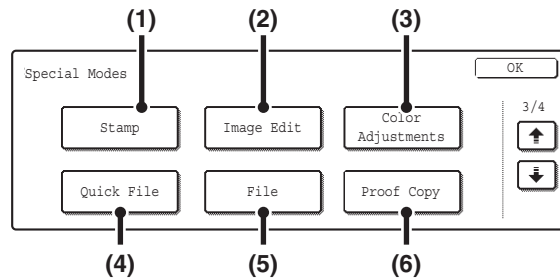

### (1) [Stamp] key

Use this to print the date, a stamp, the page number and/or text on copies.

➤ [PRINTING THE DATE AND A STAMP ON COPIES \(Stamp\)](#) (page 102)

### (2) [Image Edit] key

Touch this key to display the image edit menu screen. This allows you to select special image editing functions.

➤ [\[Image Edit\] KEY AND \[Color Adjustments\] KEY](#) (page 57)

### (3) [Color Adjustments] key

Touch this key to display the color adjustment menu screen. This allows you to select special color adjustment functions when making color copies.

➤ [\[Image Edit\] KEY AND \[Color Adjustments\] KEY](#) (page 57)

### (4) [Quick File] key

This saves a job in the Quick File folder of the document filing function. For more information on Quick File, see the Document Filing Guide.

### (5) [File] key

This saves a job in a folder of the document filing function. For more information on File, see the Document Filing Guide.

### (6) [Proof Copy] key

This feature prints only one set of copies, regardless of how many sets have been specified. After the first set is checked for errors, the remaining sets can be printed.

➤ [CHECKING COPIES BEFORE PRINTING \(Proof Copy\)](#) (page 151)

## 4th screen

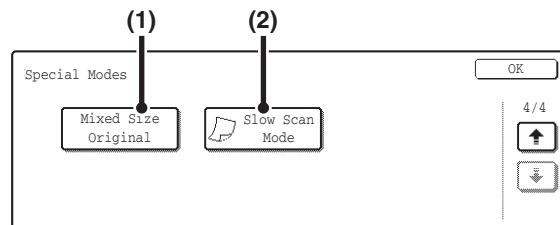

### (1) [Mixed Size Original] key

This is used to make copies of mixed size originals. The mixed size originals can be inserted together in the automatic document feeder.

➤ [COPYING ORIGINALS OF DIFFERENT SIZES \(Mixed Size Original\)](#) (page 154)

### (2) [Slow Scan Mode] key

This is used to copy thin-paper originals using the automatic document feeder.

➤ [COPYING THIN ORIGINALS \(Slow Scan Mode\)](#) (page 157)



Special modes can generally be combined with other special modes, however, there are some combinations that are not possible. If a prohibited combination of special modes is selected, a message will appear on the touch panel.



# [Image Edit] KEY AND [Color Adjustments] KEY

A menu screen appears when the [Image Edit] key or [Color Adjustments] key is touched in the 3rd special modes screen.

## Image edit menu screen

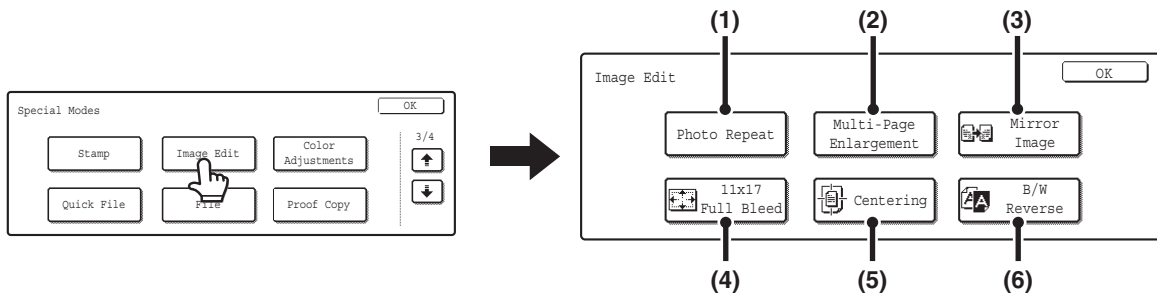

### (1) [Photo Repeat] key

This prints repeated copies of a photo on a single sheet of paper.

☞ [REPEATING PHOTOS ON A COPY \(Photo Repeat\)](#) (page 124)

### (2) [Multi-Page Enlargement] key

This enlarges an original image and prints it as a composite image using multiple sheets of paper.

☞ [CREATING A LARGE POSTER \(Multi-Page Enlargement\)](#) (page 127)

### (3) [Mirror Image] key

This is used to print a mirror image of the original.

☞ [INVERTING THE IMAGE \(Mirror Image\)](#) (page 130)

### (4) [11x17 Full Bleed] key

This is used to copy an entire 11" x 17" (A3) original at full size without the cutting off the edges.

☞ [COPYING AN 11" x 17" SIZE ORIGINAL WITHOUT CUTTING OFF THE EDGES \(11x17 Full Bleed\)](#) (page 132)

### (5) [Centering] key

This is used to center the copied image on the paper.

☞ [COPYING IN THE CENTER OF THE PAPER \(Centering\)](#) (page 135)

### (6) [B/W Reverse] key

This is used to reverse black and white in a copy to create a negative image. This function can only be used for black and white copying.

☞ [REVERSING WHITE AND BLACK IN A COPY \(B/W Reverse\)](#) (page 137)

## Color adjustments menu screen

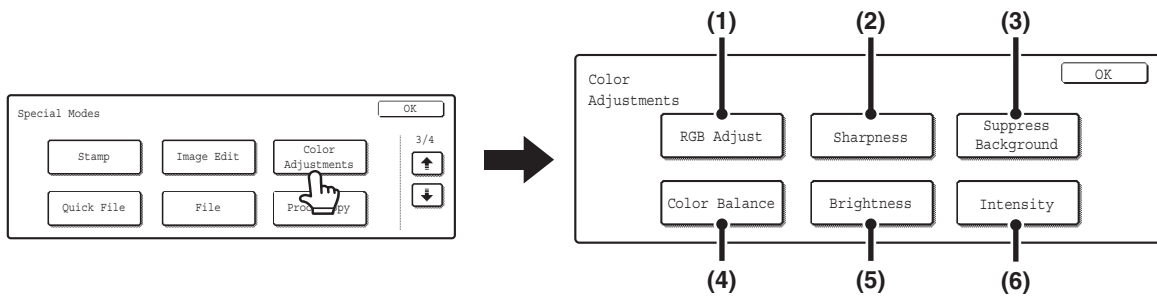

### (1) [RGB Adjust] key

This is used to strengthen or weaken one of the three primary colors, red (R), green (G), or blue (B).

☞ [ADJUSTING RED/GREEN/BLUE IN COPIES \(RGB Adjust\)](#) (page 139)

### (2) [Sharpness] key

This is used to sharpen an image or make it softer.

☞ [ADJUSTING THE SHARPNESS OF AN IMAGE \(Sharpness\)](#) (page 141)

### (3) [Suppress background] key

This is used to suppress unwanted light background areas on copies.

☞ [WHITENING FAINT COLORS IN COPIES \(Suppress Background\)](#) (page 143)

### (4) [Color Balance] key

The color, tone, and density of color copies can be adjusted.

☞ [ADJUSTING THE COLOR \(Color Balance\)](#) (page 145)

### (5) [Brightness] key

This is used to adjust the brightness of color images.

☞ [ADJUSTING THE BRIGHTNESS OF A COPY \(Brightness\)](#) (page 147)

### (6) [Intensity] key

This is used to adjust the intensity (saturation) of color images.

☞ [ADJUSTING THE INTENSITY OF A COPY \(Intensity\)](#) (page 149)

## [OK] keys in the special modes screen

Two [OK] keys may appear in the special modes screen. The [OK] keys are used as follows:

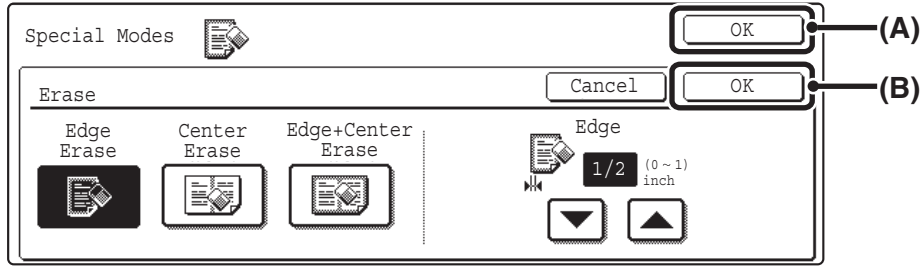

- (A) Enter the selected special mode settings and return to the base screen of copy mode or to the job detail settings screen.
- (B) Enter the selected special mode settings and return to the special modes menu screen. Touch this key when you wish to continue selecting other special mode settings.

## Checking which special modes are selected

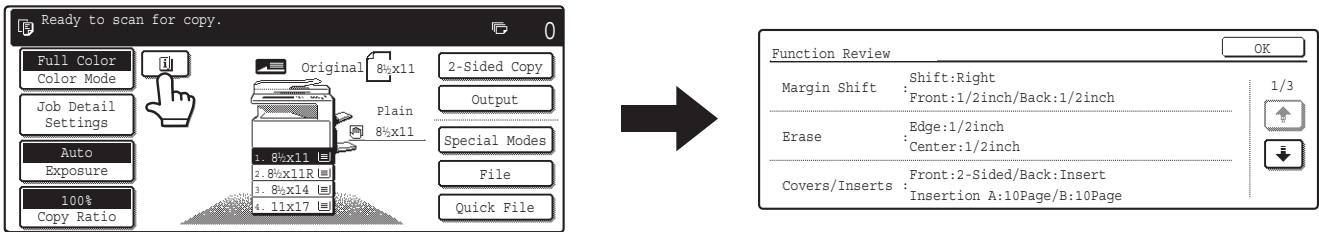

When one or more special modes are selected, the  key appears in the base screen.

The  key can be touched to display a list of the selected special modes.

# ADDING MARGINS (Margin Shift)

This function is used to shift the copy image right, left or down to adjust the margin. This is convenient when you wish to bind the copies with a string or in a binder.

**Shifting the image to the right so the copies can be bound at the left edge with a string**

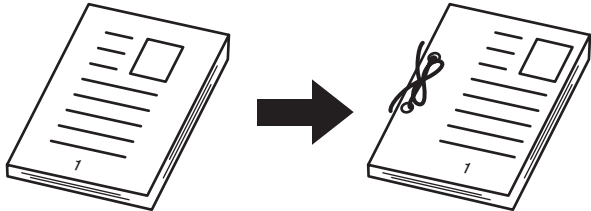

Not using margin shift	Using margin shift
<p>The punch holes cut off part of the image</p>	<p>The image is shifted to the right to allow space for the string holes so the image is not cut off.</p>

## Margin shift positions

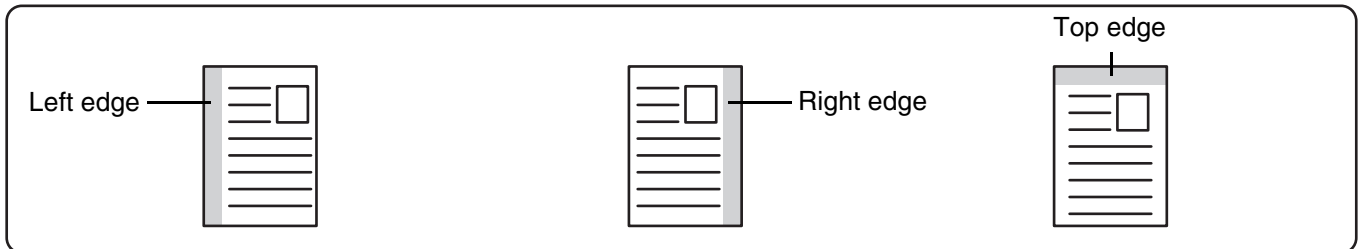

1

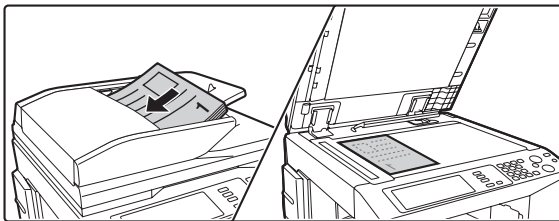

### Place the original.

Place the original face up in the document feeder tray, or face down on the document glass.

2

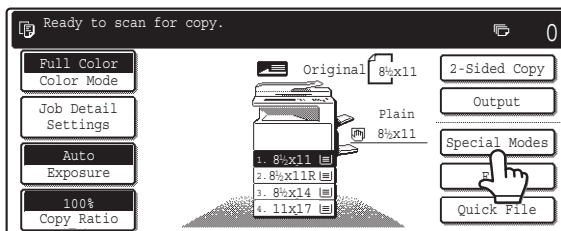

### Touch the [Special Modes] key.

3

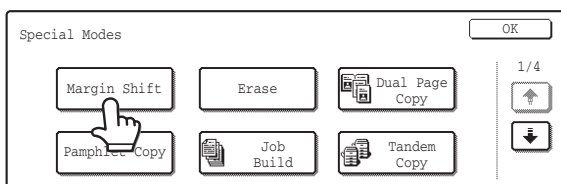

### Touch the [Margin Shift] key.

4

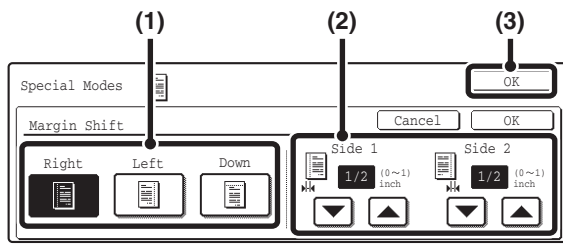

## Set the margin shift.

### (1) Touch the margin shift position.

Select one of the three positions.

### (2) Set the amount of the margin shift with



0" to 1" (0 mm to 20 mm) can be entered.

### (3) Touch the [OK] key.

You will return to the base screen of copy mode.

5

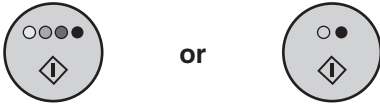

or

## Press the [COLOR START] key (○●●●) or the [BLACK & WHITE START] key (●●).

Copying will begin.

- If the originals were placed in the document feeder tray, the originals are copied.
- If you are using the document glass, copy each page one page at a time. If you are using the sort function or other function that requires all originals to be scanned before the copies are printed, you must use the same [START] key that you used to scan the first original to scan each of the remaining originals.



### To cancel scanning of the original and copying...

Press the [STOP] key (⊘).



Rotation copy cannot be used in combination with margin shift.



### To cancel the margin shift setting...

Touch the [Cancel] key in the screen of step 4.



### System Settings (Administrator): Initial Margin Shift Setting

The default margin shift setting can be set from 0" to 1" (0 mm to 20 mm). The factory default setting is "1/2" (10 mm)".

# ERASING PERIPHERAL SHADOWS (Erase)

The erase function is used to erase shadows around the edges of copies that occur when copying thick originals or books.

When a thick book is copied...

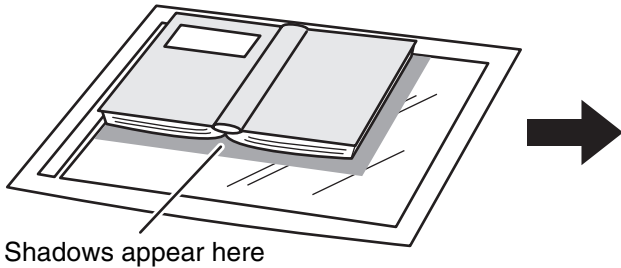

Not using the erase function	Using the erase function
<p>Shadows appear on the copy.</p>	<p>Shadows do not appear on the copy.</p>

## Erase modes

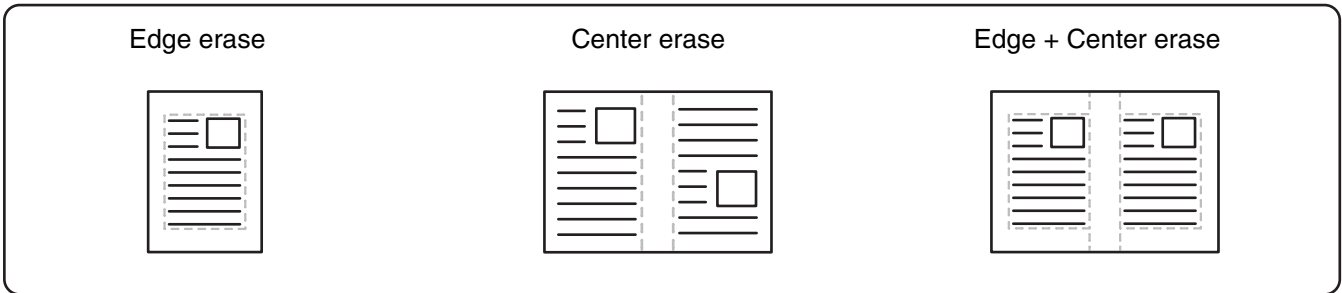

1

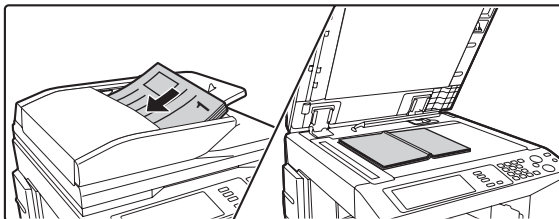

### Place the original.

Place the original face up in the document feeder tray, or face down on the document glass.

2

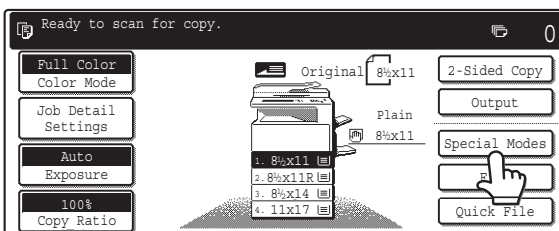

### Touch the [Special Modes] key.

3

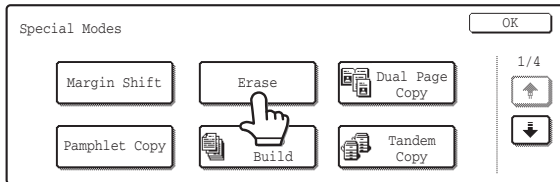

Touch the [Erase] key.

4

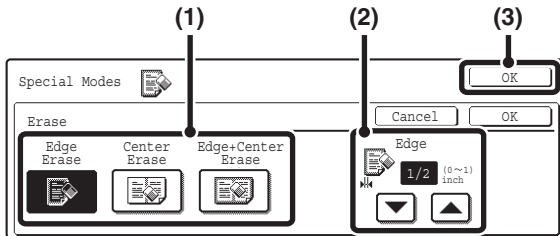

Select the erase settings.

(1) Touch the desired erase mode.

Select one of the three positions.

(2) Set the erasure width with .

0" to 1" (0 mm to 20 mm) can be entered.

(3) Touch the [OK] key.

You will return to the base screen of copy mode.

5

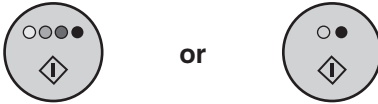

Press the [COLOR START] key (●●●●) or the [BLACK & WHITE START] key (●●).

Copying will begin.

- If the originals were placed in the document feeder tray, the originals are copied.
- If you are using the document glass, copy each page one page at a time. If you are using the sort function or other function that requires all originals to be scanned before the copies are printed, you must use the same [START] key that you used to scan the first original to scan each of the remaining originals.



**To cancel scanning of the original and copying...**

Press the [STOP] key (⊘).



When the erase function is used, erase takes place at the edges of the original image. If you also use a ratio setting, the erase width will change according to the selected ratio. For example, if the erase width setting is 1" (20 mm) and the copy is reduced to 50%, the erase width will be 1/2" (10 mm).



**To cancel the erase setting...**

Touch the [Cancel] key in the screen of step 4.



**System Settings (Administrator): Erase Width Adjustment**

The default erase width can be set from 0" to 1" (0 mm to 20 mm). The factory default setting is "1/2" (10 mm)".

# COPYING EACH FACING PAGE OF A BOUND DOCUMENT (Dual Page Copy)

The dual page copy function produces separate copies of 2 document pages placed side by side on the document glass. This function is useful when making copies of the facing pages of a book or other bound document.

## Copying the facing pages of a book or bound document

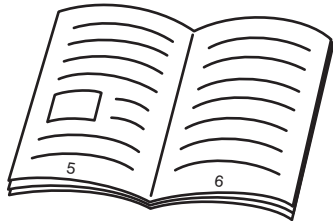

Book or bound document

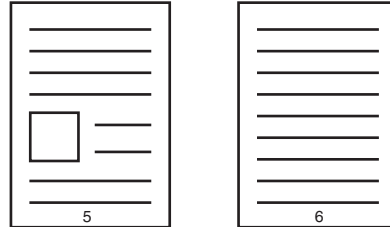

The facing pages are separated into 2 copy pages.

1

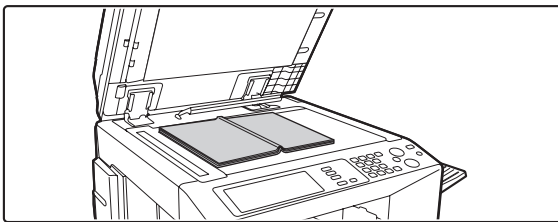

Place the original on the document glass.

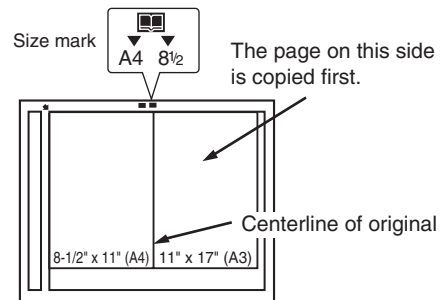

Place the original with the page that you wish to copy first on the right. Align the centerline of the original with the size mark.

2

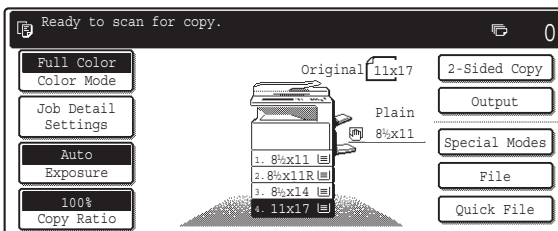

Select 8-1/2" x 11" (A4) size paper.

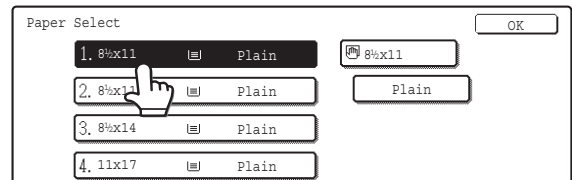

3

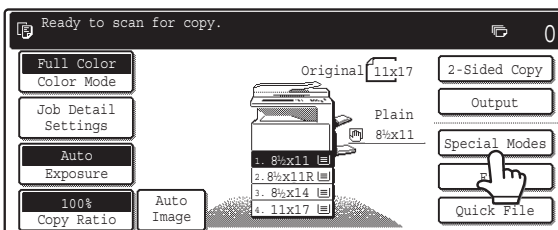

Touch the [Special Modes] key.

4

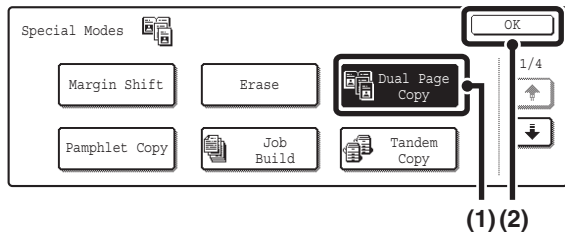

### Select Dual Page Copy.

(1) Touch the [Dual Page Copy] key so that it is highlighted.

(2) Touch the [OK] key.

You will return to the base screen of copy mode.

5

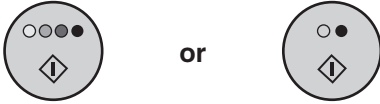

Press the [COLOR START] key (○●●●) or the [BLACK & WHITE START] key (○●).

Copying will begin.

If you are using the document glass, copy each page one page at a time. If you are using the sort function or other function that requires all originals to be scanned before the copies are printed, you must use the same [START] key that you used to scan the first original to scan each of the remaining originals.



**To cancel scanning of the original and copying...**

Press the [STOP] key (⊘).



- When using dual page copy, the original must be placed on the document glass.
- Only 8-1/2" x 11" (A4) paper can be used.
- To erase shadows caused by the binding of a book or other bound document, use the erase function.  
Note that the center erase and edge + center erase modes of the erase function cannot be used with dual page copy.



**To cancel dual page copy...**

Touch the [Dual Page Copy] key in the screen of step 4 so that it is not highlighted.



# MAKING COPIES IN PAMPHLET FORMAT (Pamphlet Copy)

This function copies 2 original pages onto the front side and 2 original pages onto the reverse side of each sheet of paper so that the copies can be folded at the centerline to form a pamphlet.

This function is convenient for arranging copies into an attractive booklet or pamphlet.

## Pamphlet copy using 8 original pages

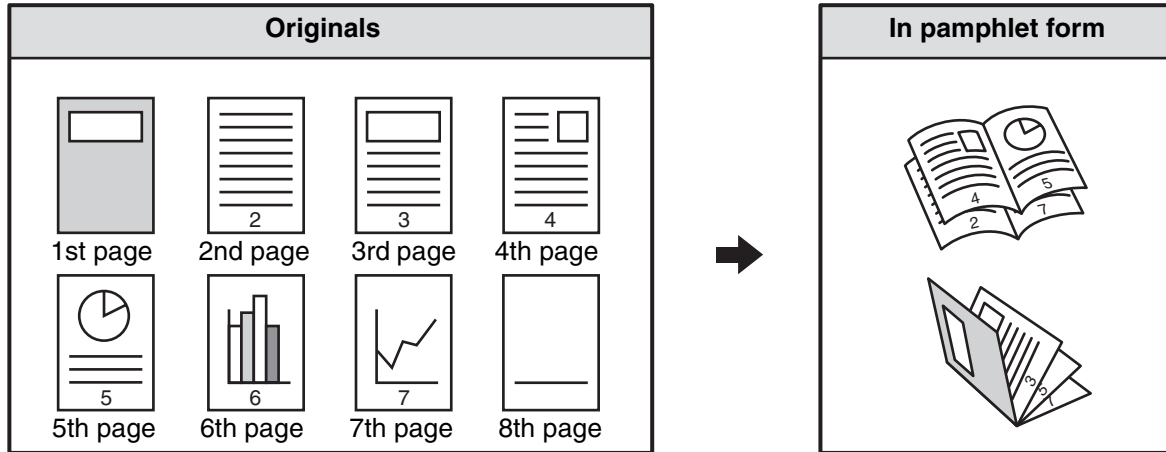

## Binding side

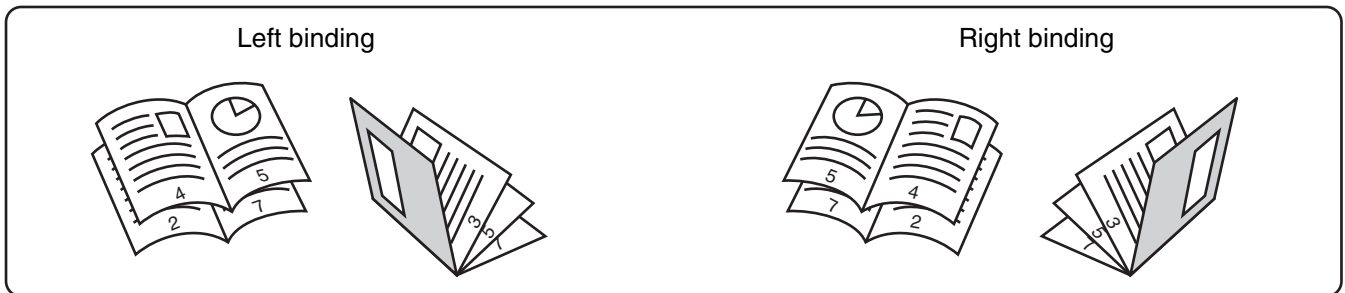

1

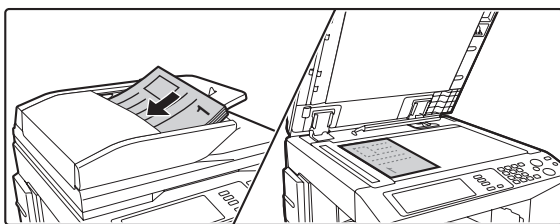

## Place the original.

Place the original face up in the document feeder tray, or face down on the document glass.



If the originals are 2-sided, place them in the document feeder tray.

2

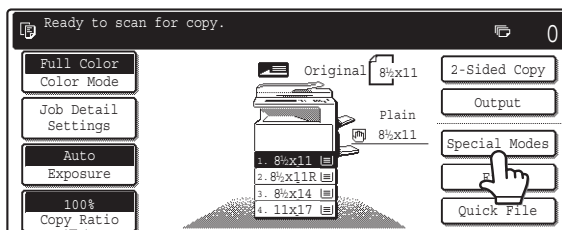

## Touch the [Special Modes] key.

3

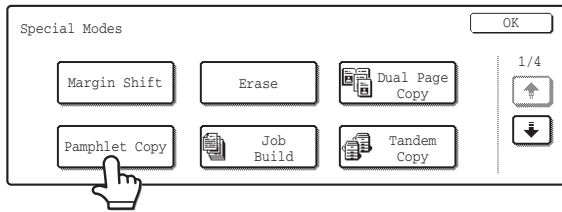

Touch the [Pamphlet Copy] key.

4

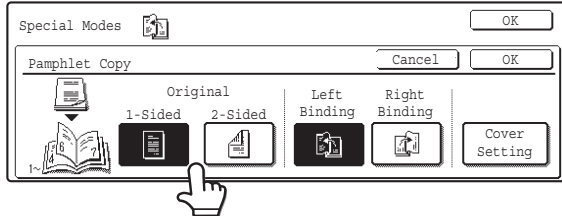

Specify whether the original is a 1-sided or 2-sided original.

When using the document feeder tray, select the [2-Sided] key.

5

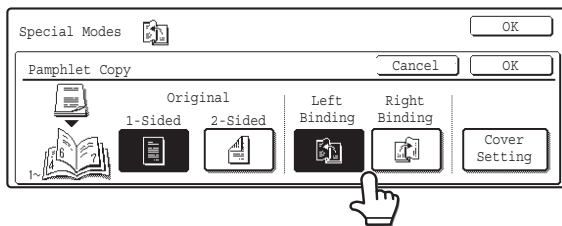

Select the binding edge ([Left Binding] or [Right Binding]).

6

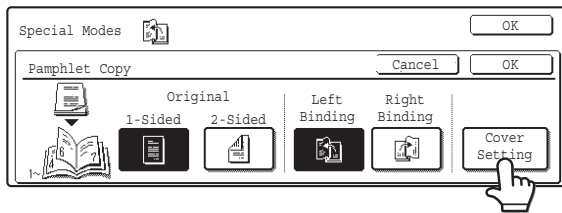

Specify whether or not a cover will be added.

If a different type of paper will be used for the cover, touch the [Cover Setting] key.

If a cover will not be added, go to step 10.

7

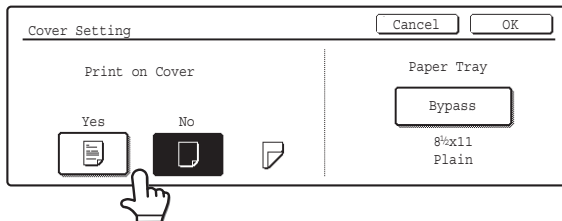

If the cover sheet will be copied on, touch the [Yes] key. Otherwise, touch the [No] key.

8

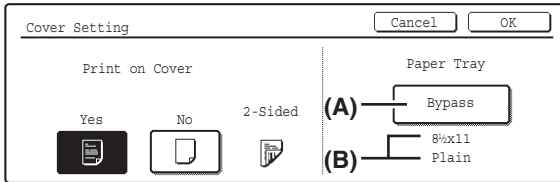

### Select the paper tray for the cover.

- (A) The currently selected paper tray for the cover is displayed.
- (B) The size and type of paper in the currently selected tray is displayed.

In the example screen, 8-1/2" x 11" (A4) size plain paper is loaded in the bypass tray.

To change the paper tray for the cover, touch the tray selection key. (In the screen example, the "Bypass" display is the tray selection key.)

The tray selection screen appears when the tray selection key is touched. Select the paper tray for the cover in the tray selection screen and touch the [OK] key.

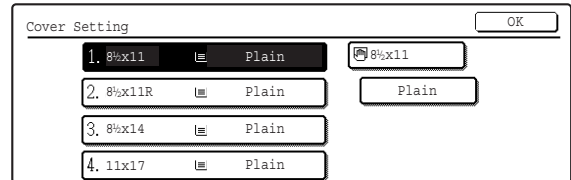

If the cover will be copied on, label sheets, transparency film, and tab paper cannot be used.

9

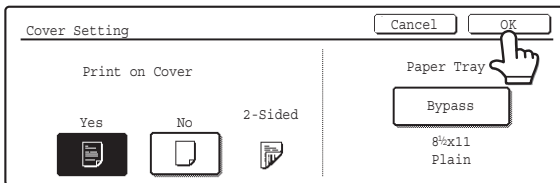

### Touch the [OK] key.



To cancel cover settings... Touch the [Cancel] key.

10

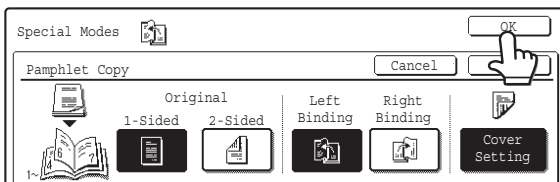

### Touch the [OK] key.

You will return to the base screen of copy mode.

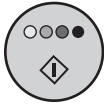

or

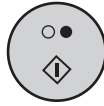

Press the [COLOR START] key (○●●●) or the [BLACK & WHITE START] key (○●).

Copying will begin.

- If the originals were placed in the document feeder tray, the originals are copied.
- If you are using the document glass, copy each page one page at a time. If you are using the sort function or other function that requires all originals to be scanned before the copies are printed, you must use the same [START] key that you used to scan the first original to scan each of the remaining originals.



#### To cancel scanning of the original and copying...

Press the [STOP] key (⊘).



- To make pamphlet copies of a book or other bound original, use the book copy function.
- When the pamphlet copy function is selected, 2-sided copying mode is automatically selected. When settings are selected that prevent 2-sided copying, the pamphlet copy function cannot be used.
- Scan the originals in order from the first page to the last page. The order of copying will be automatically adjusted by the machine. Four original pages will be copied onto each sheet of paper. Blank pages may be automatically produced at the end depending on the number of original pages.
- When a saddle stitch finisher is installed, saddle stitch can be used. When pamphlet copy is used in combination with the saddle stitch function and the number of originals is greater than the number of sheets that can be stapled, a message will appear showing the [Cancel] key, the [Continue] key, and the [Divide] key. To cancel the job, touch the [Cancel] key. To make pamphlet copies without stapling, touch the [Continue] key. To divide the pages into sets that can be stapled, touch the [Divide] key.  
If you selected settings for adding a cover, it will not be possible to select "Divide". You can either continue pamphlet copying without stapling, or cancel the job.



#### To cancel pamphlet copy...

Touch the [Cancel] key in the screen of step 4.



#### System Settings (Administrator): Automatic Saddle Stitch

When a saddle stitch finisher is installed, this setting can be enabled to have saddle stitch take place automatically when the pamphlet copy function is selected.

# COPYING A LARGE NUMBER OF ORIGINALS AT ONCE (Job Build)

When copying a very large number of originals, this function allows you to divide the originals into sets and feed each set through the automatic document feeder one set at a time.

Use this function when you wish to copy all of the originals as a single job but the number of originals exceeds the maximum number that can be inserted.

This function is convenient when you wish to sort copies of a large number of originals into multiple sets because all originals are copied as a single job, which saves you the trouble of sorting the copies that would be required if the originals were divided into separate copy jobs.

When scanning the original in sets, divide the sheets so that no set has more than 100 sheets, and then scan from the set with the first page. The settings that you select for the first set can be used for all remaining sets.

## Sorting the copies of a large number of originals into 2 sets

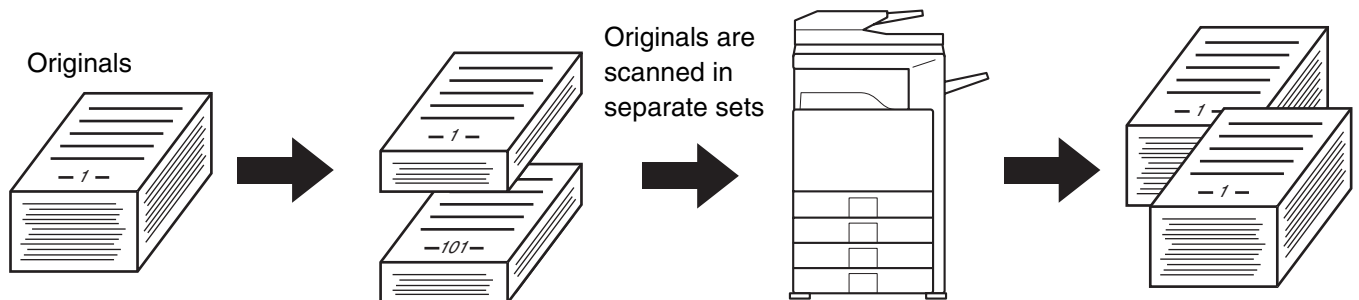

1

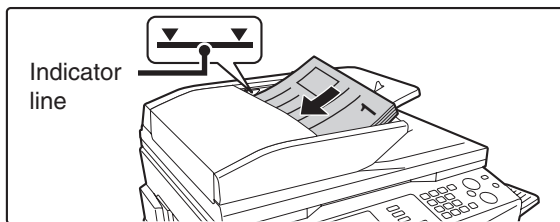

**Place the originals face up in the document feeder tray with the edges aligned evenly.**

Place the originals face up. Insert the originals all the way into the document feeder tray. The stack must not be higher than the indicator line (no more than 100 sheets).

2

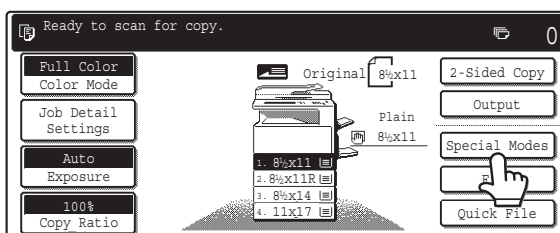

**Touch the [Special Modes] key.**

3

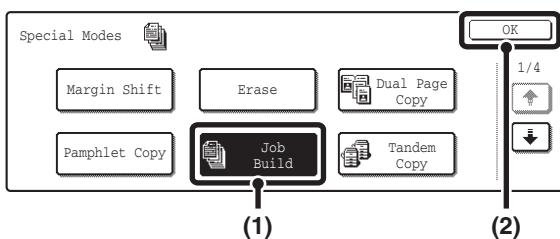

**Select Job Build.**

**(1) Touch the [Job Build] key so that it is highlighted.**

**(2) Touch the [OK] key.**

You will return to the base screen of copy mode.

4

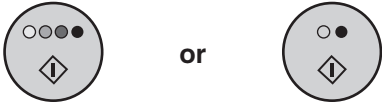

Press the [COLOR START] key (○●●●) or the [BLACK & WHITE START] key (○●) to scan the first set of originals.

Scanning begins.



**To cancel scanning...**

Press the [STOP] key (⊘).

5

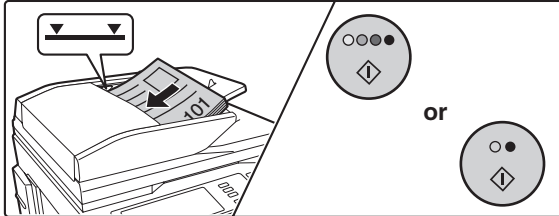

Insert the next set of originals and press the [COLOR START] key (○●●●) or the [BLACK & WHITE START] key (○●).

You must use the same [START] key that you used to scan the first set of originals to scan each of the remaining sets. Repeat this step until all originals have been scanned.



**To cancel scanning...**

Press the [STOP] key (⊘).

6

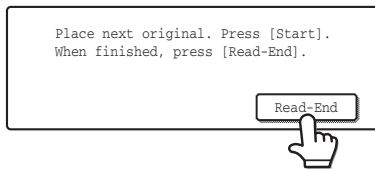



Touch the [Read-End] key.



**To cancel copying...**

Press the [STOP] key (⊘).

 If the Quick File Folder of the document filing function is full, copying in job build mode will be affected. Delete unneeded files from the Quick File Folder.

 **To cancel the job build setting....** Touch the [Job Build] key in the screen of step 3 so that it is not highlighted.

# USING TWO MACHINES TO COPY A LARGE NUMBER OF ORIGINALS (Tandem Copy)

Two machines connected to the same network can be used to run a large copy job in parallel. Each machine prints half of the copies, reducing the time required to complete the job.

## Master machine and slave machine

In the following explanation, the master machine is the machine that is used to scan the originals. The slave machine is another machine specified in the master machine that only helps print the copies; it is not used to scan the originals.

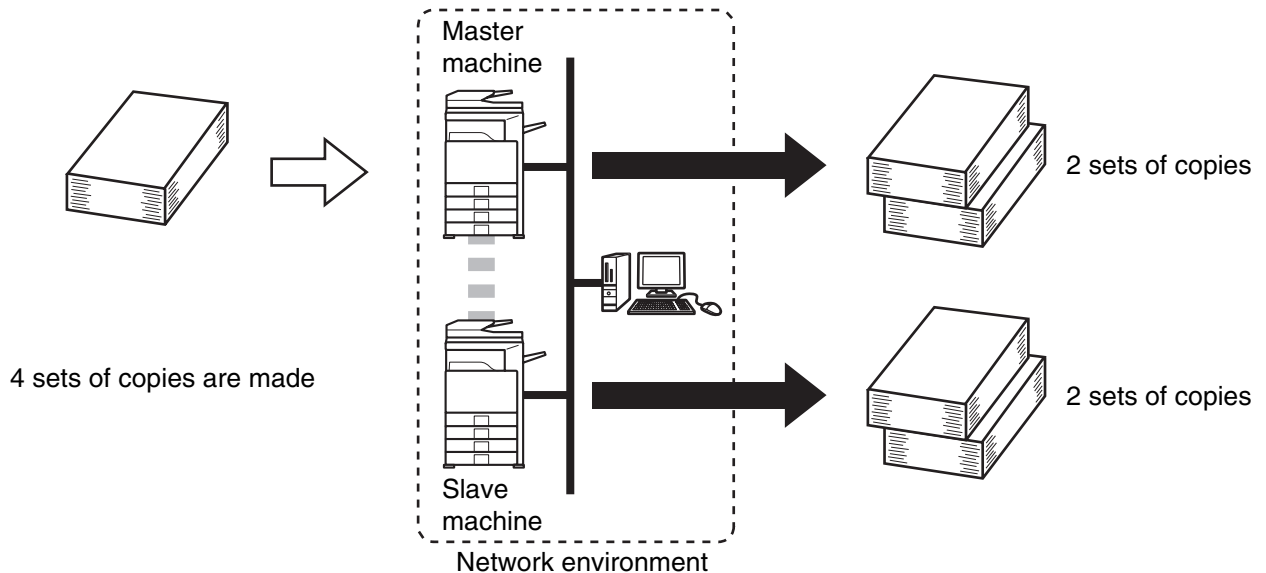

## Before using tandem copy

- To use this function, two machines must be connected to your network. Even if more machines are connected to the network, this function can only be used to have one other machine share a job.
- To use the tandem copy function, "Tandem Connection Setting" must be configured in the system settings (administrator).
- When configuring the system settings in the master machine, the IP address of the slave machine is required. For the port number, it is best to use the initial setting (50001). Unless you experience difficulty with this setting, do not change the port number. The tandem settings should be configured by your network administrator. If the master machine and slave machine will change roles, configure the IP address information of the master machine in the slave machine. Both machines can use the same port number.

1

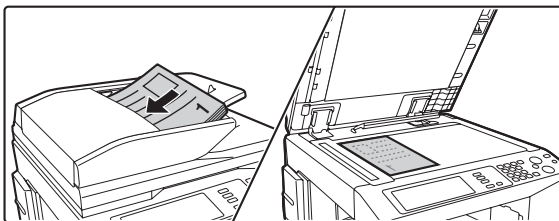

## Place the original.

Place the original face up in the document feeder tray, or face down on the document glass.

2

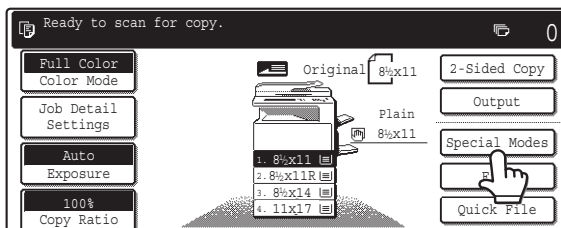

## Touch the [Special Modes] key.

3

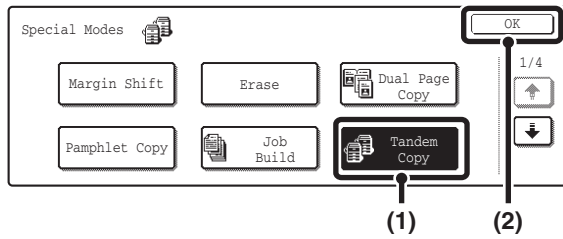

### Select tandem copy.

- (1) Touch the [Tandem Copy] key so that it is highlighted.
- (2) Touch the [OK] key.

You will return to the base screen of copy mode.

4



### Set the number of copies with the numeric keys.

Up to 999 can be set. When the [COLOR START] key (○●●●) or the [BLACK & WHITE START] key (○●) is pressed, the copies will automatically be divided between the master and slave machines.

If an odd number of copies is set, the master machine will print the extra set.



#### If an incorrect number of copies is set...

Press the [CLEAR] key (□) and then enter the correct number.

5

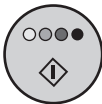

or



### Press the [COLOR START] key (○●●●) or the [BLACK & WHITE START] key (○●).

Copying will begin.

- If the originals were placed in the document feeder tray, the originals are copied.
- If you are using the document glass, copy each page one page at a time. If you are using the sort function or other function that requires all originals to be scanned before the copies are printed, you must use the same [START] key that you used to scan the first original to scan each of the remaining originals.

The following screen appears when the [START] key is pressed.

Starting tandem operation.  
Please wait.

After the message appears, tandem copying begins.

If tandem copying is not possible, the following screen appears.

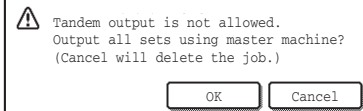

To have the master machine make all copies, touch the [OK] key. To cancel the job, touch the [Cancel] key.



#### To cancel scanning...

Press the [STOP] key (⊙).

#### To cancel tandem copying...

Touch the [STOP] keys (⊙) on both the master machine and the slave machine.





#### **In this situation...**

##### **A saddle stitch finisher is installed on the master machine but not on the slave machine.**

- Copying without stapling: tandem copy is possible.
- Copying with stapling: tandem copy is not possible.

In this way, if tandem copying is executed using a function that the slave machine does not have, a message will appear. To have the master machine make all copies, touch the [OK] key. To cancel the job, touch the [Cancel] key.

##### **If a machine runs out of paper**

If either the master machine or the slave machine run out of paper, the machine that ran out of paper will hold the job while the machine that still has paper continues the job. When paper is added to the machine that ran out, the job resumes.

##### **When user authentication is enabled**

User authentication is enabled in the master machine: tandem copying is possible.

User authentication is enabled in the slave machine but not in the master machine: tandem copying is not possible.



#### **To cancel tandem copy...**

Touch the [Tandem Copy] key in the screen of step 3 so that it is not highlighted.



#### **System Settings (Administrator): Tandem Connection Setting**

This must be configured to use the tandem function. This can also be used to disable the tandem function.

---

---

# USING A DIFFERENT PAPER TYPE FOR COVERS (Covers/Inserts)

A different type of paper can be inserted in positions corresponding to front and back covers of a copy job when the automatic document feeder is used. A different type of paper can also be automatically added as an insert at specified pages.

Example of adding covers

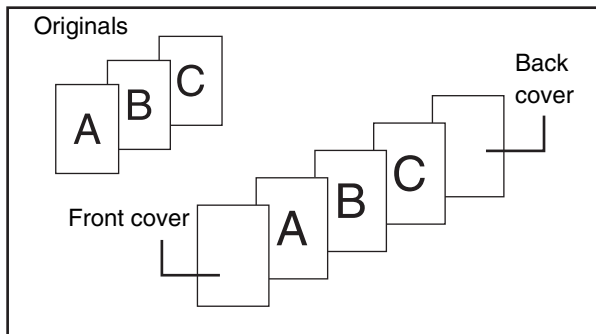

Example of adding inserts

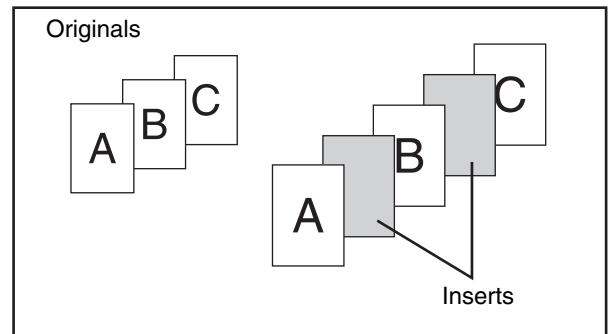

Example of adding covers/inserts

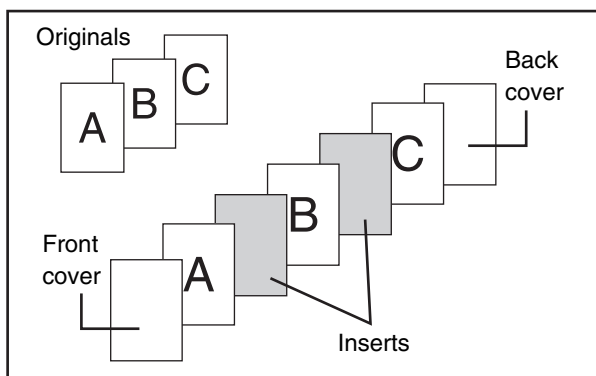

## About the explanations of covers and inserts

There are various ways of using covers and inserts. To keep the explanations simple, covers and inserts are explained separately. Refer to "[Examples of covers and inserts](#)" (page 163) as needed.

## Preparations for using covers and inserts

- Load the cover/insert paper in the tray before using the cover/insert function.
- Before selecting the cover/insert function, place the originals in the document feeder tray, select 1-sided or 2-sided copying, and select the number of copies and any other desired copy settings. When these settings have been completed, perform the procedure to select covers/inserts.
- The originals must be scanned using the automatic document feeder. The document glass cannot be used.
- Up to 100 cover/insert sheets can be inserted. Note that two insert sheets cannot be inserted between the same pages.
- This function cannot be used in combination with the saddle stitch function.
- When performing 2-sided copying of 2-sided originals, an insert cannot be added between the front and reverse sides of an original page.

# INSERTING COVERS IN COPIES (Cover Settings)

A different type of paper can be inserted at the positions corresponding to the front and back covers of a copy job. This is useful for arranging documents in an attractive format and for using a different type of paper as a cover on an estimate sheet.

Covers can be used in combination with inserts.

## Copying on a front cover and inserting together with a back cover

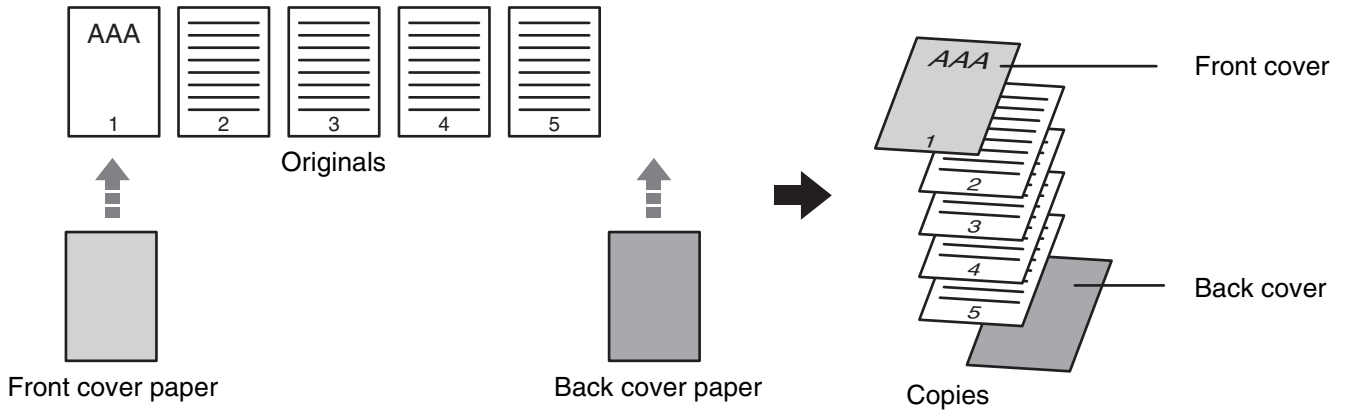

1

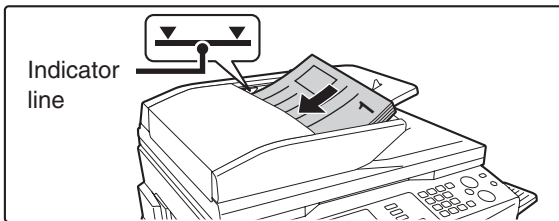

**Place the originals face up in the document feeder tray with the edges aligned evenly.**

Place the originals face up. Insert the originals all the way into the document feeder tray. The stack must not be higher than the indicator line (no more than 100 sheets).



The document glass cannot be used.

2

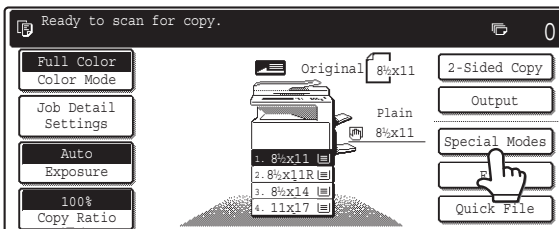

**Touch the [Special Modes] key.**

3

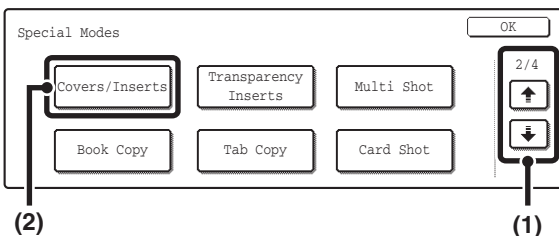

**Select Covers/Inserts.**

(1) Touch the keys to switch through the screens.

(2) Touch the [Covers/Inserts] key.

4

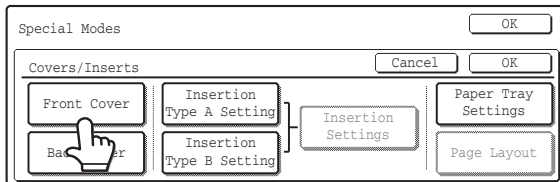

Touch the [Front Cover] key.

5

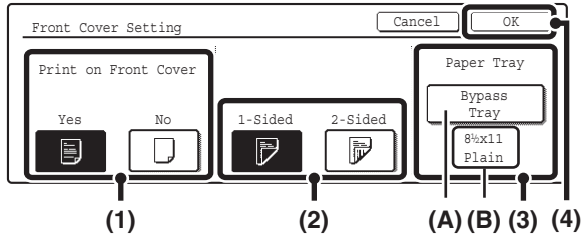

Select front cover settings.

In the example screen, 8-1/2" x 11" (A4) size plain paper in the bypass tray is selected.

- (1) If you wish to copy on the front cover, touch the [Yes] key.
- (2) If you touched [Yes] in (1), touch the [1-Sided] key if copying will be 1-sided or the [2-Sided] key if copying will be 2-sided.
- (3) To change the paper tray used for the front cover, touch the tray select key.

(A) The currently selected paper tray for the cover is displayed.

(B) The size and type of paper in the currently selected tray is displayed.

In the example screen, 8-1/2" x 11" (A4) size plain paper is loaded in the bypass tray.

To change the paper tray for the cover, touch the tray selection key. (In the screen example, the "Bypass Tray" display is the tray selection key.)

The tray selection screen appears when the tray selection key is touched. Select the paper tray for the cover in the tray selection screen and touch the [OK] key.

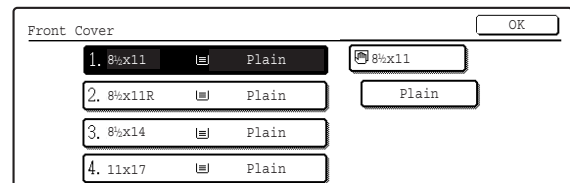

- (4) Touch the [OK] key.



If both sides of the cover will be copied on, label sheets, transparency film, and tab paper cannot be used.

6

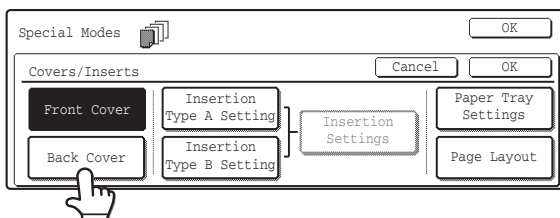

If you wish to insert a back cover, touch the [Back Cover] key.

The screen of step 5 appears. The procedures are the same as for the front cover. Follow the procedures in step 5.

When following the procedures, substitute "Back Cover" for "Front Cover".

7

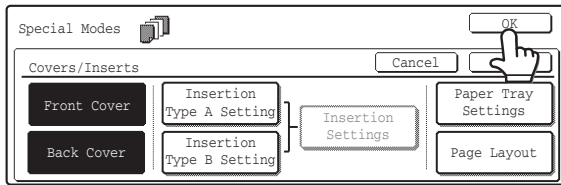

### Touch the [OK] key.

You will return to the base screen of copy mode.  
To check your settings, touch the [Page Layout] key.

➔ [CHANGING COVER/INSERT SETTINGS \(Page Layout\)](#)  
(page 81)

8

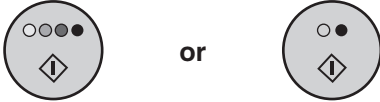

### Press the [COLOR START] key (○●●●) or the [BLACK & WHITE START] key (○●).

Copying of the originals in the document feeder tray begins.



#### To cancel scanning of the original and copying...

Press the [STOP] key (⊞).



- This function cannot be used in combination with the saddle stitch function.
- The document glass cannot be used.
- Cover settings cannot be selected if insertion of covers and inserts is disabled in the System Settings (Administrator).



#### To cancel cover sheet insertion...

Touch the [Cancel] key in the screen of step 4.

# INSERTING INSERT SHEETS IN COPIES (Insert Settings)

You can have different paper automatically inserted as an insert at specified pages of copies. Two types of paper can be used as inserts, and the insertion positions can be specified separately for each.

Covers can be used in combination with inserts.

**Example: Insert A after page 3 and insert B after page 5.**

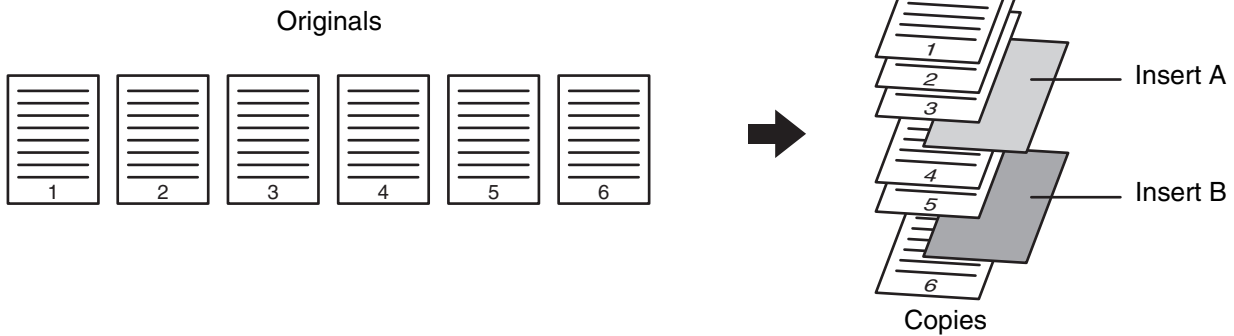

1

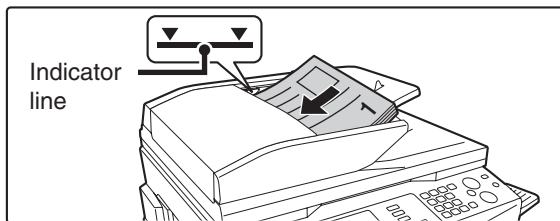

**Place the originals face up in the document feeder tray with the edges aligned evenly.**

Place the originals face up. Insert the originals all the way into the document feeder tray. The stack must not be higher than the indicator line (no more than 100 sheets).



The document glass cannot be used.

2

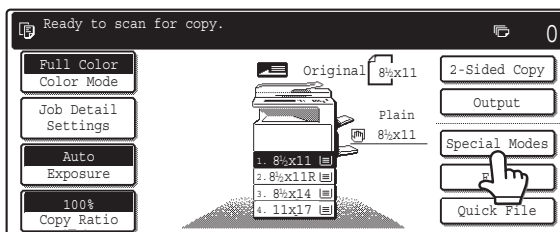

**Touch the [Special Modes] key.**

3

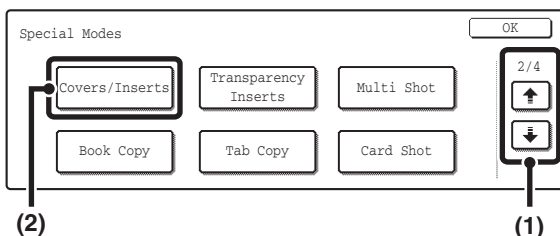

**Select Covers/Inserts.**

(1) Touch the keys to switch through the screens.

(2) Touch the [Covers/Inserts] key.

4

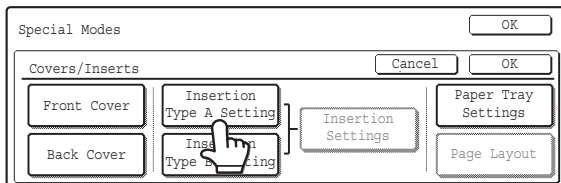

Touch the [Insertion Type A Settings] key.

5

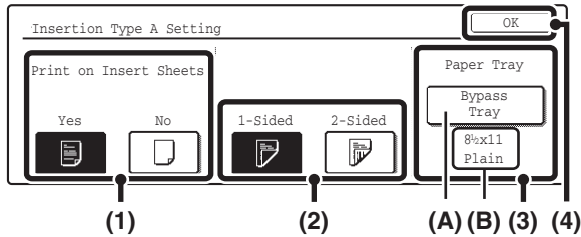

### Select settings for insert type A.

In the example screen, 8-1/2" x 11" (A4) size plain paper in the bypass tray is selected.

- (1) If you wish to copy on insert type A, touch the [Yes] key.
- (2) If you selected [Yes] in (1), touch the [1-Sided] key if copying will be 1-sided or the [2-Sided] key if copying will be 2-sided.
- (3) To change the paper tray used for insert type A, touch the tray select key.

(A) The currently selected paper tray for the insert is displayed.

(B) The size and type of paper in the currently selected tray is displayed.

In the example screen, 8-1/2" x 11" (A4) size plain paper is loaded in the bypass tray.

To change the paper tray for the inserts, touch the tray selection key. (In the screen example, the "Bypass Tray" display is the tray selection key.)

The tray selection screen appears when the tray selection key is touched. Select the paper tray for the inserts in the tray selection screen and touch the [OK] key.

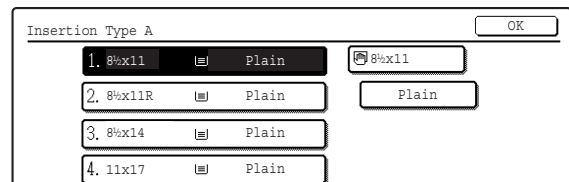

- (4) Touch the [OK] key.



If both sides of the insert will be copied on, label sheets, transparency film, and tab paper cannot be used.

6

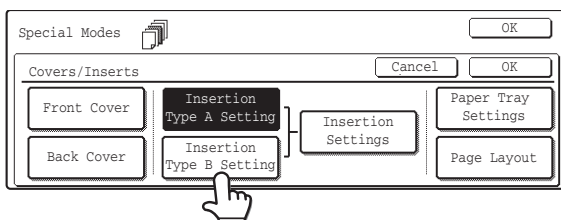

If you wish to insert a different type of insert sheet, touch the [Insertion Type B Setting] key.

The screen of step 5 appears. Settings are selected in the same way as for insert type A. Follow the procedures in step 5. When following the procedures, substitute "Insert Type B" for "Insert Type A".

7

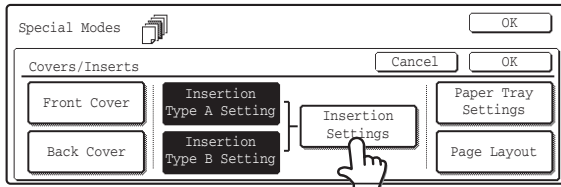

Touch the [Insertion Settings] key.

8

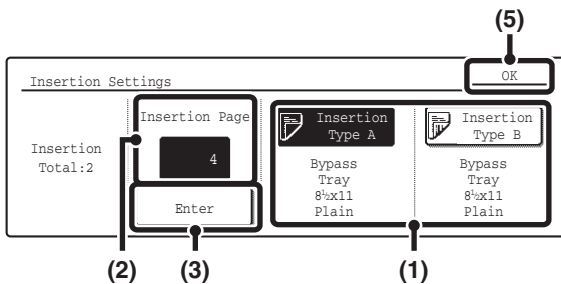

Specify the pages where inserts A and B will be inserted.

(1) Touch the [Insertion Type A] key or the [Insertion Type B] key.

Specify the page where the highlighted insert will be inserted.

(2) Enter the page number where the insert sheet will be inserted with the numeric keys.

The example screen shows Insertion A inserted as the 4th page following the 3rd original page.

(3) Touch the [Enter] key.

(4) To insert another insert sheet, repeat steps (1) to (3).

(5) Touch the [OK] key.

### ● Insertion settings screen

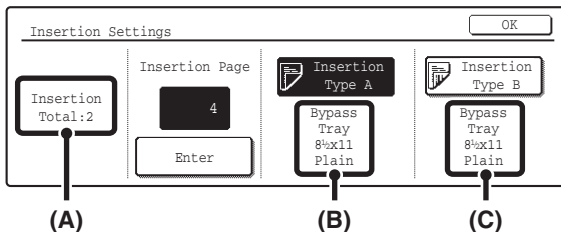

(A) This shows the total number of inserts. Up to 100 insert sheets can be inserted. To insert multiple inserts, touch the [Enter] key after entering each insertion page number (insertion position) with the numeric keys.

(B) This shows the tray selected for insert type A and the paper size and type.

(C) This shows the tray selected for insert type B and the paper size and type.

When the [Insertion Type A] key is highlighted, the insert settings are applied to [Insertion Type A Settings]. When the [Insertion Type B] key is highlighted, the insert settings are applied to [Insertion Type B Settings].



If both sides of the insert will be copied on, label sheets, transparency film, and tab paper cannot be used.

9

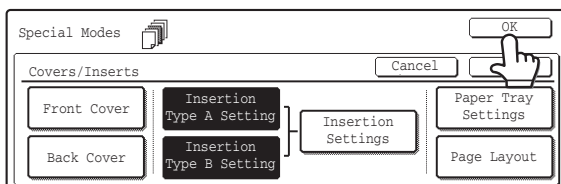

Touch the [OK] key.

You will return to the base screen of copy mode.

To check your settings, touch the [Page Layout] key.

➡ [CHANGING COVER/INSERT SETTINGS \(Page Layout\)](#) (page 81)



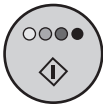

or



Press the [COLOR START] key (○●●●) or the [BLACK & WHITE START] key (○●).

Copying of the originals in the document feeder tray begins.



**To cancel scanning of the original and copying...**

Press the [STOP] key (⏹).



- Use the same size of paper for the inserts as for the copies.
- Up to 100 insert sheets can be added. Note that two insert sheets cannot be inserted between the same pages.
- When performing 2-sided copying of 2-sided originals, an insert cannot be added between the front and reverse sides of an original page.
- This function cannot be used in combination with the saddle stitch function.
- Insert settings cannot be selected if insertion of covers and inserts is disabled in the system settings (administrator).



**To cancel insert sheet insertion...**

Touch the [Cancel] key in the screen of step 4.

## CHANGING COVER/INSERT SETTINGS (Page Layout)

Cover settings and insert settings can be combined.

This section explains how to check cover and insert insertion pages, and change or delete insertion pages.

### Changing insert A from page 4 to page 5

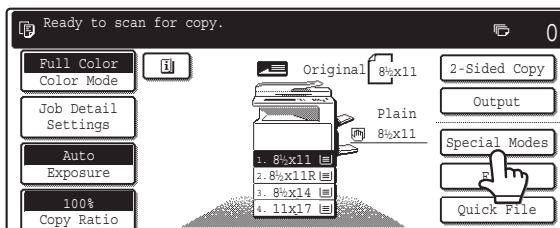
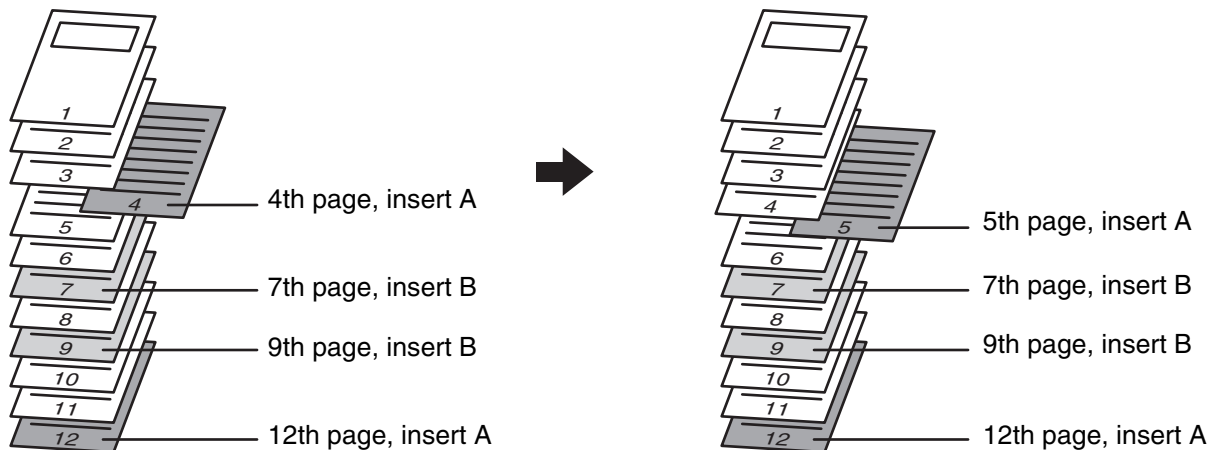

Touch the [Special Modes] key.

2

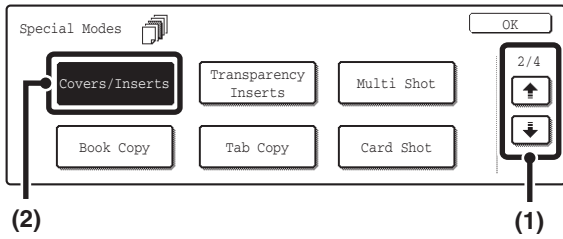

### Select Covers/Inserts.

- (1) Touch the keys to switch through the screens.
- (2) Touch the [Covers/Inserts] key.

3

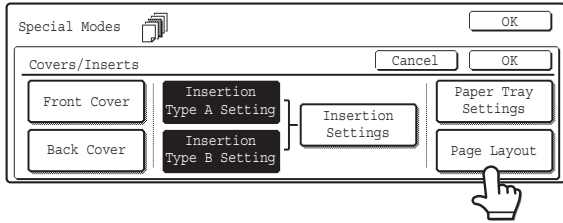

### Touch the [Page Layout] key.

4

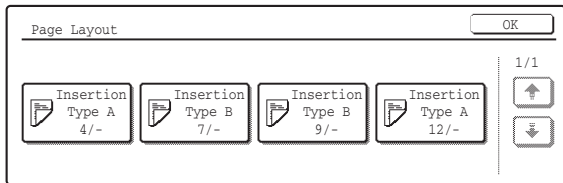

### Check the currently specified cover/insert page layout.

Each key shows a print image icon and the insertion page. If there are multiple screens, touch the keys to change screens.

If you are only checking the layout, touch the [OK] key and go to step 8.

#### ● Icons

- : Copy on front side only
- : Copy on reverse side only
- : 2-sided copy
- : Do not copy

For inserts, the insertion page also appears.

\* represents a page number.

- \*/-: Copy only on front side at page \*
- \*/\*: 2-sided copy at page \*/\*
- <\*: Insert without copying at page \*

5

#### Example: Touch insert A at page 4

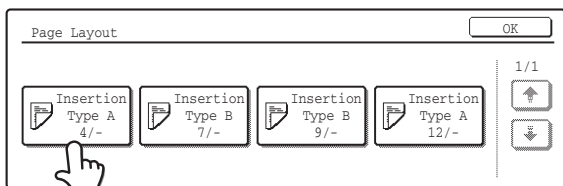

### Touch the key of the page that you wish to delete or change.

The following screen will appear.

- To delete the page, touch the [Delete] key. After deleting the key, touch the [OK] key and go to step 8.
- To change the page, touch the [Modify] key. To change a cover, go to step 6. To change an insert, go to step 7.
- To cancel, touch the [Cancel] key.

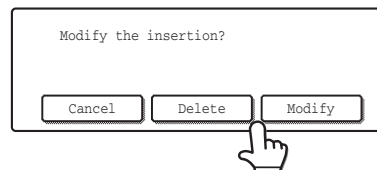

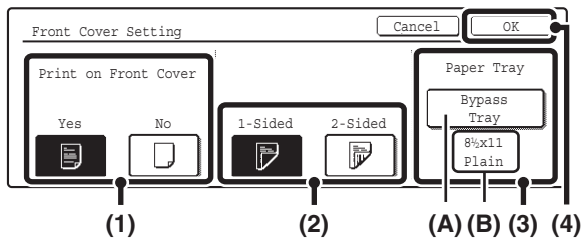

## Change the cover settings.

The procedure for changing a front cover is explained below. A back cover is changed in the same way.

- (1) If you wish to copy on the front cover, touch the [Yes] key.
- (2) If you touched [Yes] in (1), touch the [1-Sided] key if copying will be 1-sided or the [2-Sided] key if copying will be 2-sided.
- (3) To change the paper tray used for the front cover, touch the tray select key.

(A) The currently selected paper tray for the cover is displayed.

(B) The size and type of paper in the currently selected tray is displayed.

In the example screen, 8-1/2" x 11" (A4) size plain paper is loaded in the bypass tray.

To change the paper tray for the cover, touch the tray selection key. (In the screen example, the "Bypass Tray" display is the tray selection key.)

The tray selection screen appears when the tray selection key is touched. Select the paper tray for the cover in the tray selection screen and touch the [OK] key.

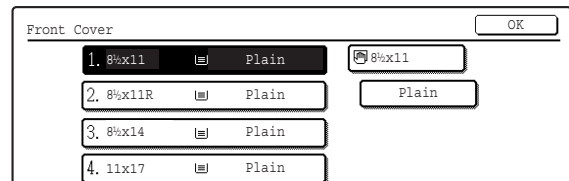

- (4) Touch the [OK] key.

You will return to the screen of step 5.



If both sides of the cover will be copied on, label sheets, transparency film, and tab paper cannot be used.

**Example: Changing the insertion page from page 4 to page 5**

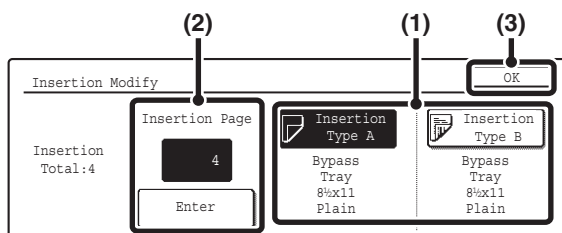

## Change the insert settings

- (1) If you wish to change to the other insert type, touch the [Insertion Type A] key or the [Insertion Type B] key.

The paper setting for insert A and insert B cannot be changed.

- (2) If you wish to change the insertion page of the insert, enter the desired page number with the numeric keys and touch the [Enter] key.

- (3) Touch the [OK] key.

You will return to the screen of step 5.

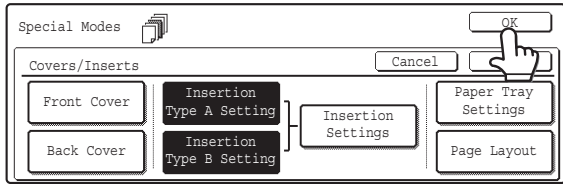

**Touch the [OK] key.**

You will return to the base screen of copy mode.

---

---

# ADDING INSERTS WHEN COPYING ON TRANSPARENCY FILM (Transparency Inserts)

When copying on transparency film, the sheets may stick together due to static electricity. The transparency inserts function can be used to automatically insert a sheet of paper between each sheet of transparency film, making the sheets easy to handle.

It is also possible to copy on the inserts.

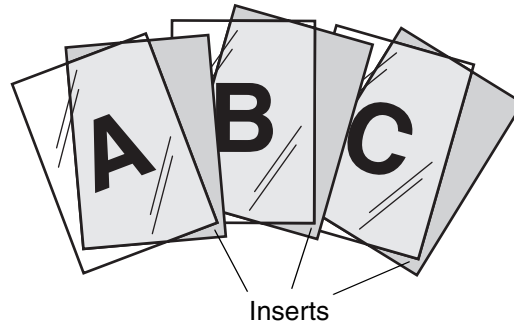

1

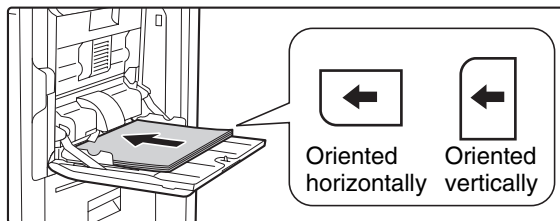

## Place the transparency film in the bypass tray.

Place the transparency film face down on the bypass tray. Transparency film can only be placed in the bypass tray. When transparency film is oriented horizontally, the rounded corner should be at the front left. When oriented vertically, the round corner should be at the rear left.

2

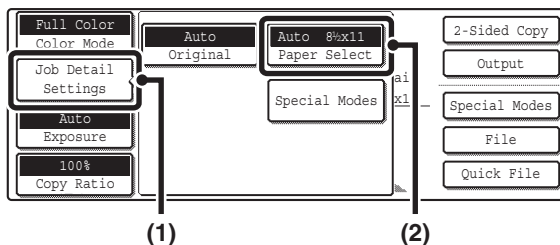

## Open the paper settings screen.

- (1) Touch the [Job Detail Settings] key.
- (2) Touch the [Paper Select] key.

3

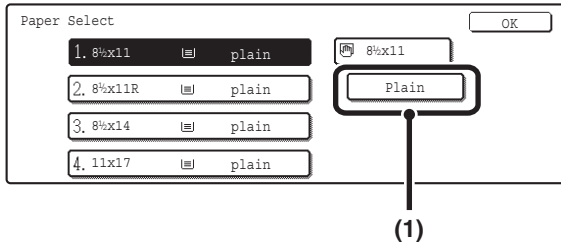

### Select the settings for using transparency film.

- (1) Touch the appropriate paper type key.
- (2) Touch the [Transparency] key.

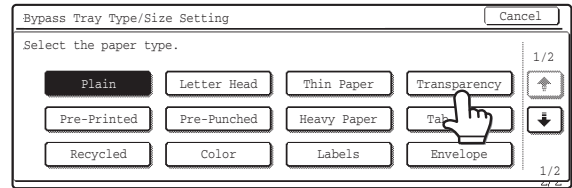

- (3) Specify the size of the transparency film.

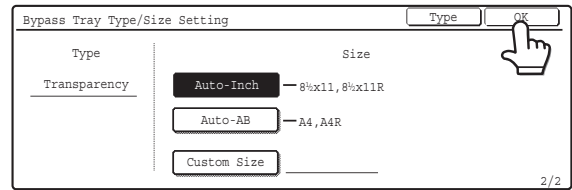

4

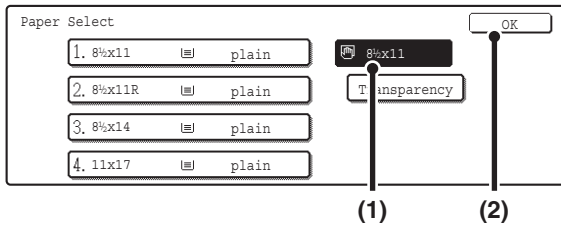

### Select the bypass tray.

- (1) Touch the paper size key of the bypass tray.
- (2) Touch the [OK] key.

When the [OK] key is touched, you will return to the job detail setting screen. Touch the [Job Detail Setting] key to return to the base screen of copy mode.

5

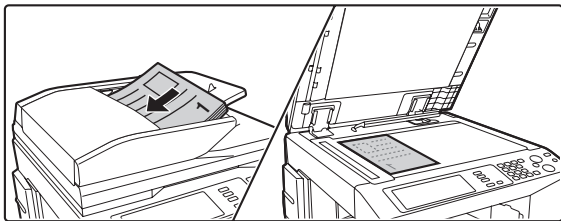

### Place the original.

Place the original face up in the document feeder tray, or face down on the document glass.

6

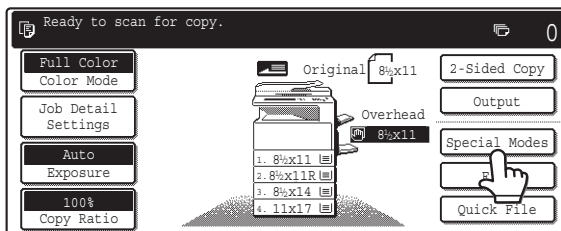

### Touch the [Special Modes] key.

7

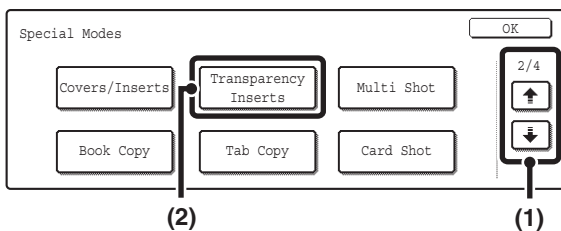

### Select Transparency Inserts.

- (1) Touch the keys to switch through the screens.
- (2) Touch the [Transparency Inserts] key.

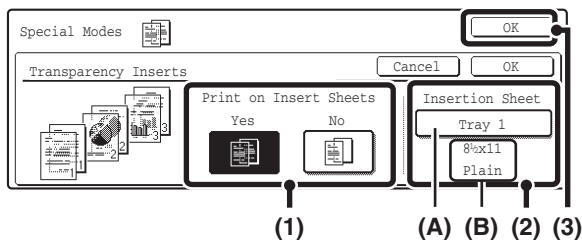

## Set the insertion conditions for the inserts.

- (1) Select whether or not the insert paper will be copied on ([Yes] or [No]).
- (2) Specify the tray name (tray position) selected for the inserts, the paper size, and the paper type.

(A) The currently selected paper tray for the insert is displayed.

(B) The size and type of paper in the currently selected tray is displayed.

In the example screen, 8-1/2" x 11" (A4) size plain paper is loaded in tray 1.

To change the paper tray for the inserts, touch the tray selection key. (In the screen example, the "Tray 1" display is the tray selection key.)

The tray selection screen appears when the tray selection key is touched. Select the paper tray for the inserts in the tray selection screen and touch the [OK] key.

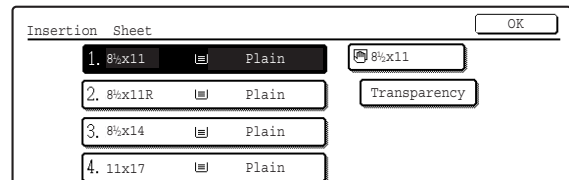

- (3) Touch the [OK] key.

You will return to the base screen of copy mode.



Select insert paper that is the same size as the transparency film.

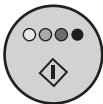

or

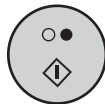

## Press the [COLOR START] key (○●●●) or the [BLACK & WHITE START] key (○●).

Copying will begin.

- If the originals were placed in the document feeder tray, the originals are copied.
- If you are using the document glass, copy each page one page at a time. If you are using the sort function or other function that requires all originals to be scanned before the copies are printed, you must use the same [START] key that you used to scan the first original to scan each of the remaining originals.



### To cancel scanning of the original and copying...

Press the [STOP] key (◻).



- The number of copies cannot be selected in this mode.
- When performing 2-sided copying, only "2-sided to 1-sided" mode can be used.



### To cancel the transparency inserts setting...

Touch the [Cancel] key in the screen of step 8.

# COPYING MULTIPLE PAGES ONTO ONE SHEET OF PAPER (Multi Shot)

Multiple original pages can be copied onto a single sheet of paper in a uniform layout. Select 2in1 to copy two original pages onto one sheet, or 4in1 to copy four original pages onto one sheet. This function is convenient when you wish to present multiple pages in a compact format, or show a view of all pages in a document. This function can also be used with 2-sided originals.

## 2in1 copying

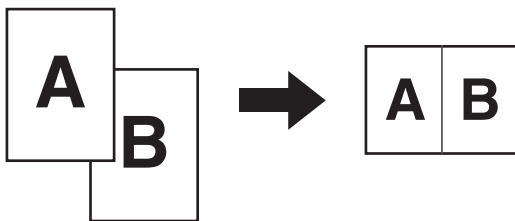

## 4in1 copying

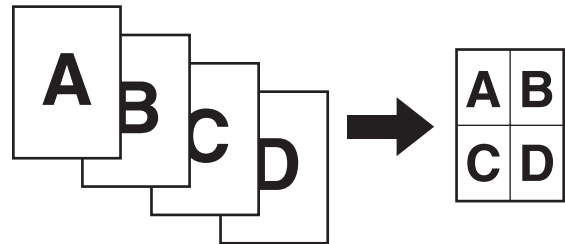

1

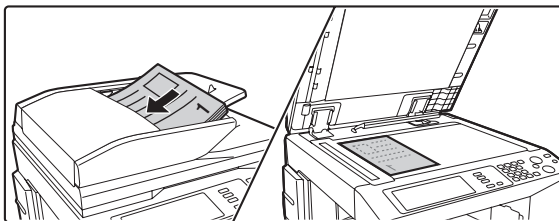

### Place the original.

Place the original face up in the document feeder tray, or face down on the document glass.

2

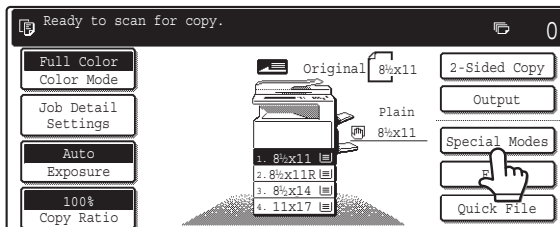

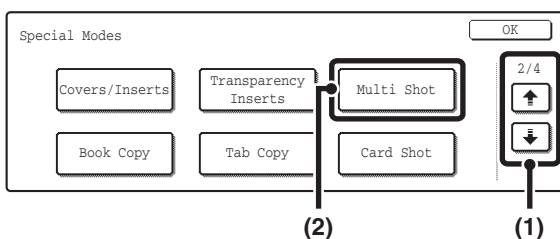

### Touch the [Special Modes] key.

3



### Select Multi Shot.

- (1) Touch the   keys to switch through the screens.
- (2) Touch the [Multi Shot] key.



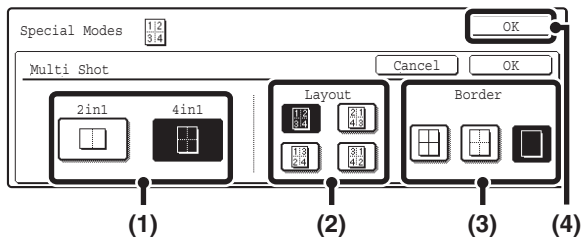

Select the number of originals to be copied onto one sheet of paper, the layout, and the border.

(1) Touch the [2in1] or the [4in1] key.

If needed, the images will be rotated.

(2) Select the layout.

Select the order in which the originals will be arranged on the copy.

Shot number	Layout
2in1	
4in1	

The arrows in the above diagram indicate how the images are arranged.

(3) Select the border.

Solid lines, broken lines, or no lines can be selected.

(4) Touch the [OK] key.

You will return to the base screen of copy mode.

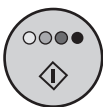

or



Press the [COLOR START] key (●●●●) or the [BLACK & WHITE START] key (●●).

Copying will begin.

- If the originals were placed in the document feeder tray, the originals are copied.
- If you are using the document glass, copy each page one page at a time. If you are using the sort function or other function that requires all originals to be scanned before the copies are printed, you must use the same [START] key that you used to scan the first original to scan each of the remaining originals.



To cancel scanning of the original and copying...

Press the [STOP] key (◻).



When using the multi shot function, the appropriate copy ratio will be automatically set based on the original size, paper size, and the number of originals to be copied onto one sheet. The minimum possible reduction ratio is 25%. The original size, paper size, and selected number of original pages may require that the ratio be less than 25%. As copying will take place at 25% in this case, part of the original images may be cut off.



**To cancel the multi shot setting...**

Touch the [Cancel] key in the screen of step 4.

# COPYING A PAMPHLET (Book Copy)

This function is used to make a copy of the two facing pages of an open book or other bound document. Copies made with this function can be folded at the center to create a booklet.

This function is convenient for arranging copies into an attractive booklet or pamphlet.

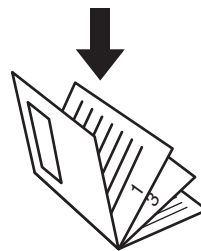
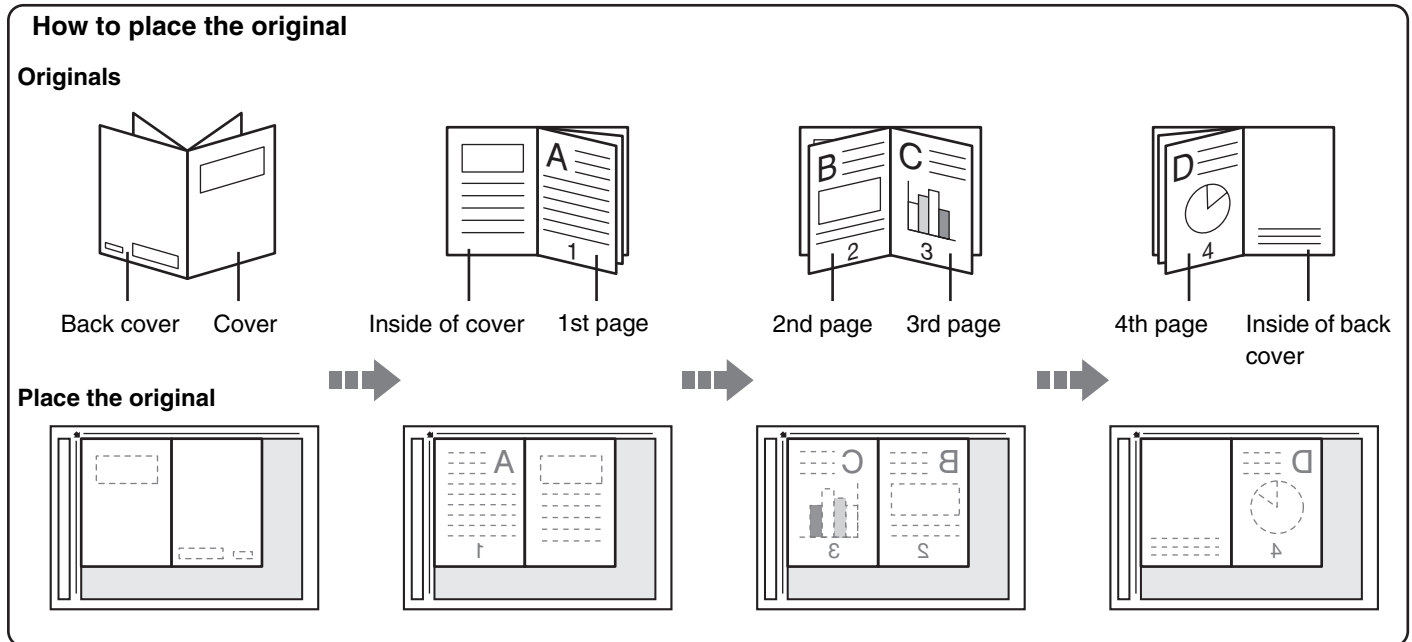

The copies are in the same layout as the original.

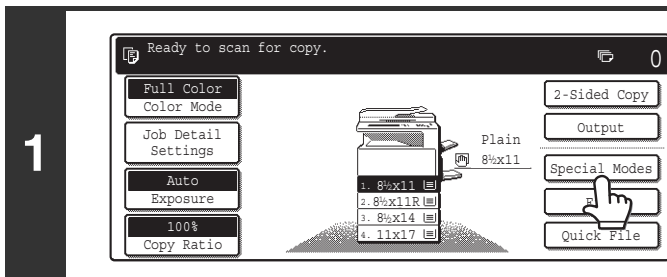

Touch the [Special Modes] key.

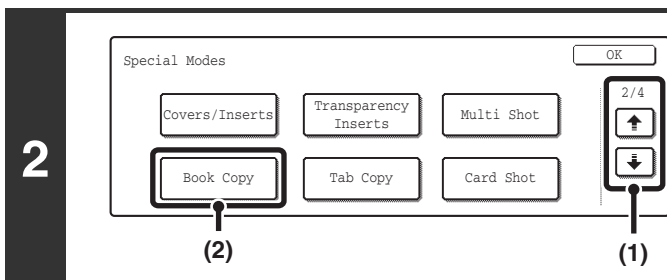

Select Book Copy.

- (1) Touch the keys to switch through the screens.
- (2) Touch the [Book Copy] key.

3

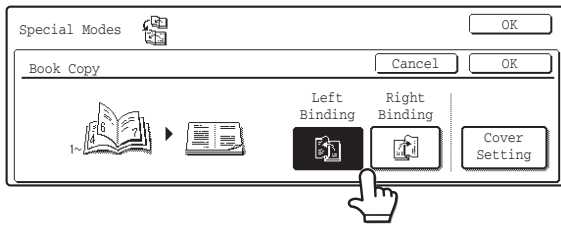

Select the binding position ([Left Binding] or [Right Binding]).

4

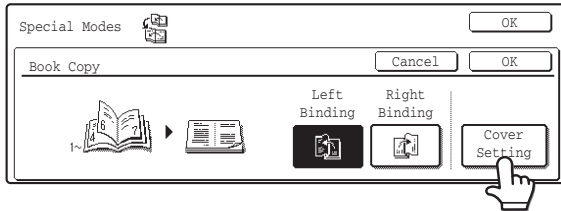

Select cover settings if needed.

If a different type of paper will be used for the cover, touch the [Cover Setting] key. If a cover will not be added, go to step 8.



Cover settings cannot be selected if insertion of covers and inserts is disabled in the system settings (administrator).

5

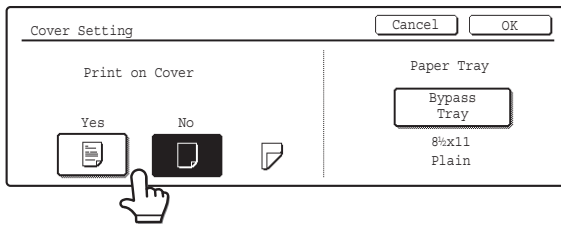

If the cover sheet will be copied on, touch the [Yes] key. Otherwise, touch the [No] key.

6

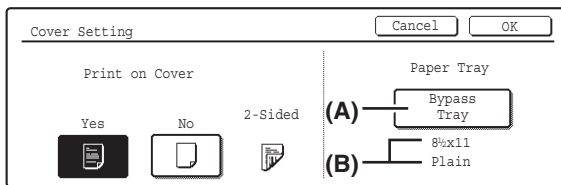

Select the paper tray for the cover.

(A) The currently selected paper tray for the cover is displayed.  
(B) The size and type of paper in the currently selected tray is displayed.

In the example screen, 8-1/2" x 11" (A4) size plain paper is loaded in the bypass tray.

To change the paper tray for the cover, touch the tray selection key. (In the screen example, the "Bypass Tray" display is the tray selection key.)

The tray selection screen appears when the tray selection key is touched. Select the paper tray for the cover in the tray selection screen and touch the [OK] key.

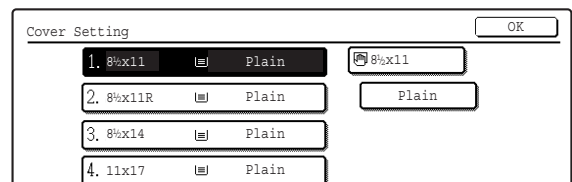

If the cover will be copied on, label sheets, transparency film, and tab paper cannot be used.

7



Touch the [OK] key.



To cancel cover settings...

Touch the [Cancel] key.

8

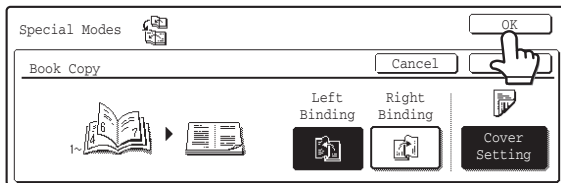

Touch the [OK] key.

You will return to the base screen of copy mode.

9

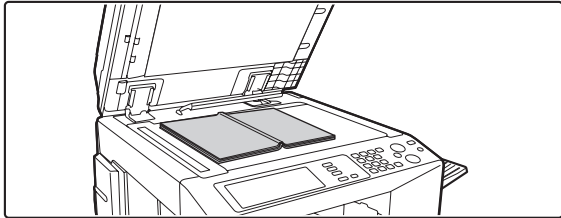

Place the original face down on the document glass.

Place the opened front cover and back cover face down.

10

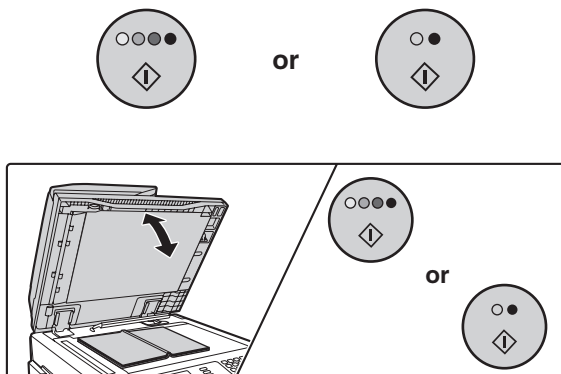

Scan the original.

- (1) Press the [COLOR START] key (●●●●) or the [BLACK & WHITE START] key (●●).
- (2) Place the next opened pages and press the [COLOR START] key (●●●●) or the [BLACK & WHITE START] key (●●).

You must use the same [START] key that you used to scan the first set of originals to scan each of the remaining sets. Repeat this step until all original pages have been scanned.

Scan the original pages in the following order:

Opened inside of front cover and 1st page

Opened 2nd and 3rd page

⋮

Opened last page and inside of back cover

Place next original. Press [Start].  
When finished, press [Read-End].

Read-End



## Touch the [Read-End] key.

Copying will begin.



### To cancel scanning of the original and copying...

Press the [STOP] key (⏹).



- Scan the originals from the first page to the last page. The order of copying will be automatically adjusted by the machine.
- Four original pages will be copied onto each sheet of paper. Blank pages may be automatically added at the end depending on the number of original pages.
- If a saddle stitch finisher is installed, the book copy function can be used in combination with the saddle stitch function.
- When book copy is selected, 2-sided copying is automatically selected. When settings that prevent 2-sided copying are selected, the book copy function cannot be used.



### To cancel book copy...

Touch the [Cancel] key in the screen of step 3.

# COPYING CAPTIONS ONTO TAB PAPER (Tab Copy)

Captions can be copied onto the tabs of tab paper. Prepare appropriate originals for the tab captions.

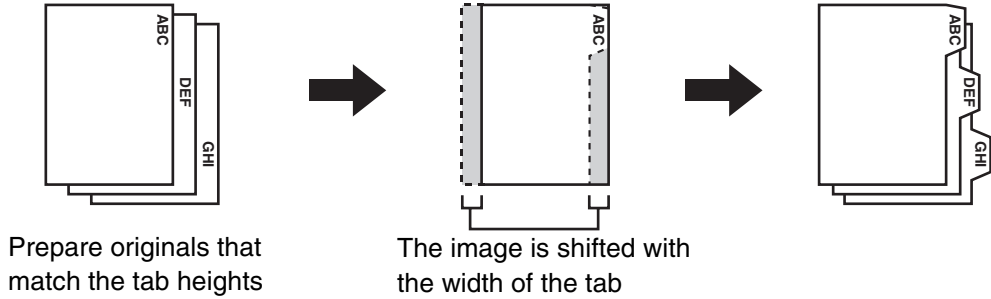

## RELATION BETWEEN THE ORIGINALS AND THE TAB PAPER

### Tab copying with a left binding

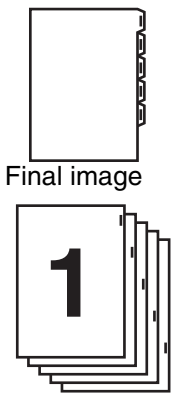
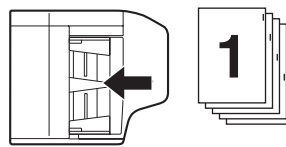
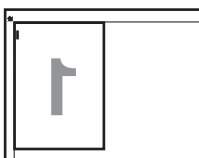
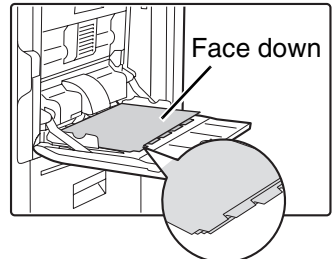
Originals	Placing the originals	Loading tab paper
 <p>Final image</p> <p>Originals</p>	<ul style="list-style-type: none"> <li>Document feeder tray</li> </ul>  <p>Insert the originals so that the side with no tab text enters first</p> <ul style="list-style-type: none"> <li>Document glass</li> </ul>  <p>Place so that the side with the tab text is on the left</p>	 <p>Face down</p> <p>Load the tab paper so that the tab on the first sheet is toward you.</p>

# Tab copying with a right binding

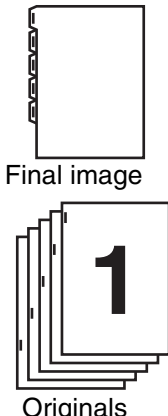
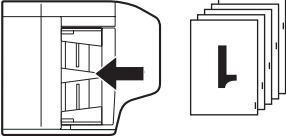
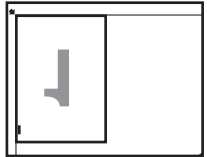
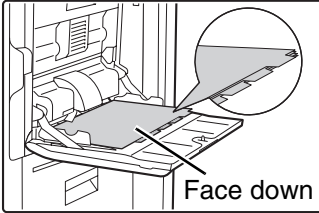
Originals	Placing the originals	Loading tab paper
 <p>Final image</p> <p>Originals</p>	<ul style="list-style-type: none"> <li>Document feeder tray            <p>Insert the originals so that the side with no tab text enters first</p> </li> <li>Document glass            <p>Place so that the side with the tab text is on the left</p> </li> </ul>	 <p>Face down</p> <p>Load the tab paper so that the tab on the first sheet is away from you.</p>

1

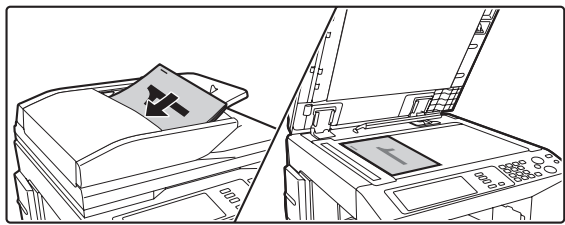

**Place the original.**

Place the original face up in the document feeder tray, or face down on the document glass.

2

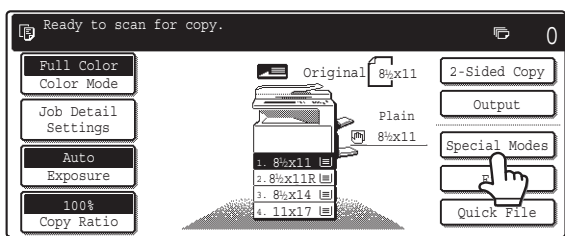

**Touch the [Special Modes] key.**

3

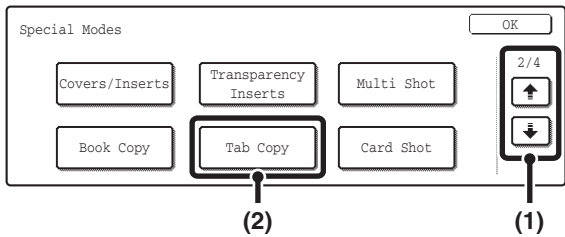

**Select Tab Copy.**

(1) Touch the key.

(2) Touch the [Tab Copy] key.



4

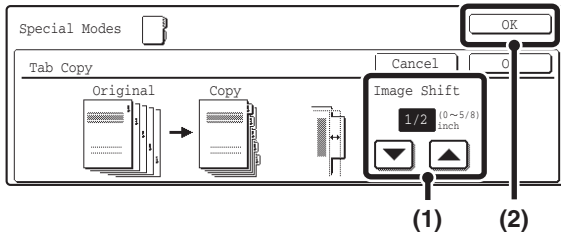

### Set the tab width.

(1) Set the image shift width (tab width) with the keys.

0" to 5/8" (0 mm to 20 mm) can be entered.

(2) Touch the [OK] key.

You will return to the base screen of copy mode.

5

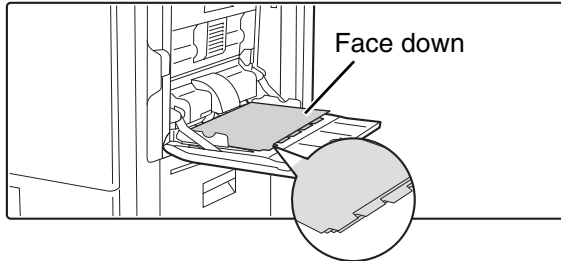

### Place tab paper in the bypass tray.

Place tab paper face down on the bypass tray.

Tab paper can only be placed in the bypass tray. Place the paper so that the sides with the tabs enter the machine last.



The width of the tab paper can be up to the width of 8-1/2" x 11" paper (8-1/2") plus 5/8" (or A4 width (210 mm) plus 20 mm).

6

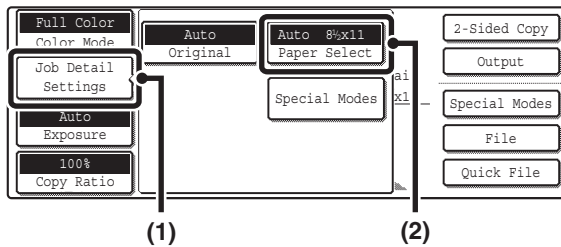

### Open the paper settings screen.

(1) Touch the [Job Detail Settings] key.

(2) Touch the [Paper Select] key.

7

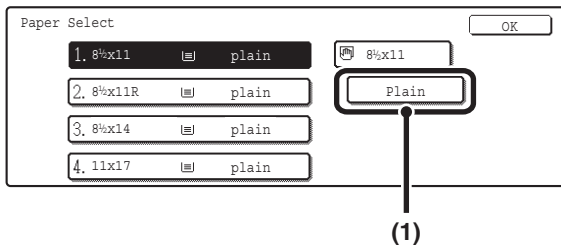

### Select settings for using tab paper.

(1) Touch the appropriate paper type key.

(2) Touch the [Tab Paper] key.

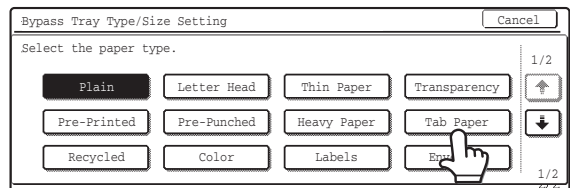

(3) Specify the size of the tab paper.

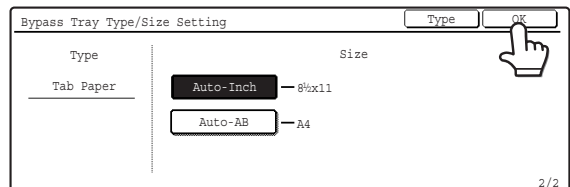

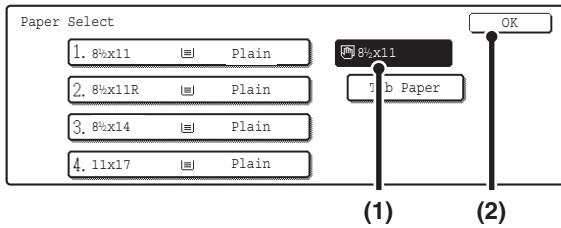

## Select the bypass tray.

- (1) Touch the paper size key of the bypass tray.
- (2) Touch the [OK] key.

When the [OK] key is touched, you will return to the job detail setting screen. Touch the [Job Detail Setting] key to return to the base screen of copy mode.

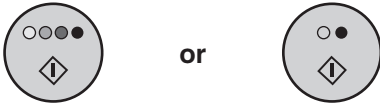

## Press the [COLOR START] key (○●●●) or the [BLACK & WHITE START] key (○●).

Copying will begin.

- If the originals were placed in the document feeder tray, the originals are copied.
- If you are using the document glass, copy each page one page at a time.

If you are using the sort function or other function that requires all originals to be scanned before the copies are printed, you must use the same [START] key that you used to scan the first original to scan each of the remaining originals.



### To cancel scanning of the original and copying...

Press the [STOP] key (⊘).



### To cancel tab copy...

Touch the [Cancel] key in the screen of step 4.



### System Settings (Administrator): Initial Tab Copy Setting

The default image shift width can be set from 0" to 5/8" (0 mm to 20 mm). The factory default setting is "1/2" (10 mm)".

# COPYING BOTH SIDES OF A CARD ON ONE SHEET OF PAPER (Card Shot)

When copying a card, this function allows you to copy the front and reverse sides together onto a single sheet of paper. This function is convenient for making copies for identification purposes and helps save paper.

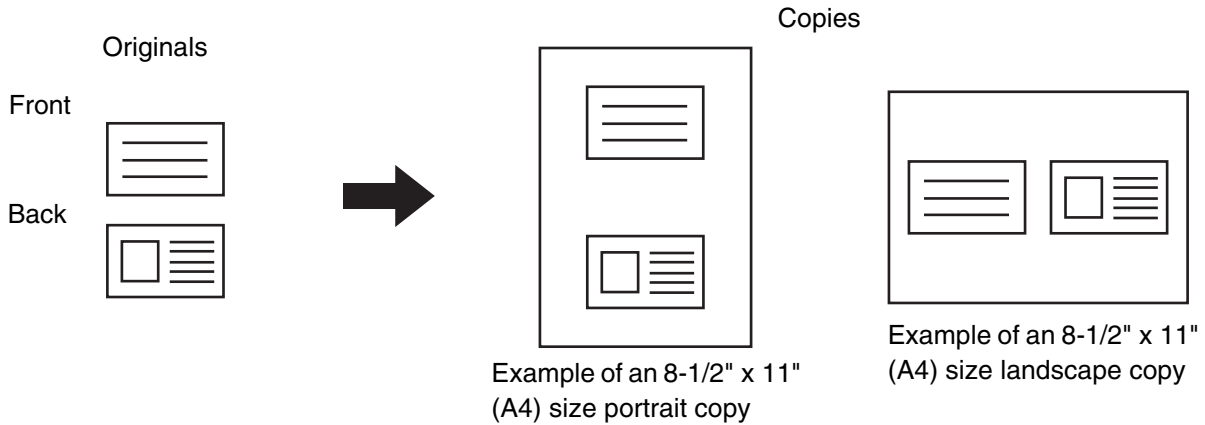

1

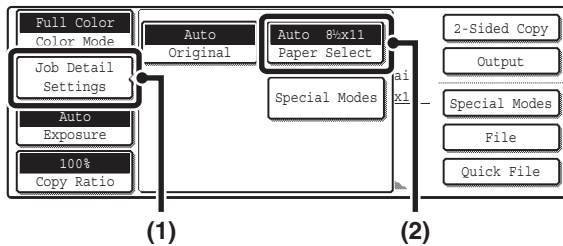

**Open the paper settings screen.**

- (1) Touch the [Job Detail Settings] key.
- (2) Touch the [Paper Select] key.

2

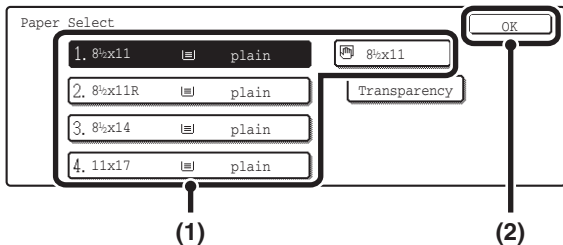

**Select the paper to be used.**

- (1) Touch the key of the desired paper size.
- (2) Touch the [OK] key.

When the [OK] key is touched, you will return to the job detail setting screen. Touch the [Job Detail Setting] key to return to the base screen of copy mode.

3

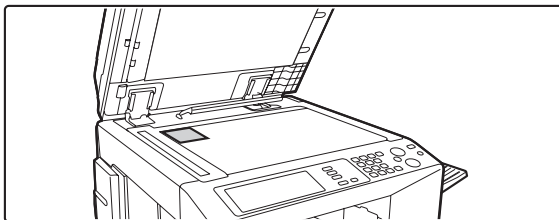

**Place the original face down on the document glass.**

4

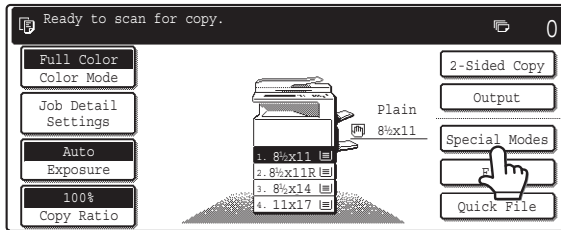

Touch the [Special Modes] key.

5

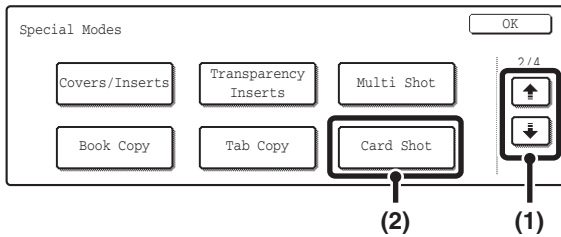

Select Card Shot.

- (1) Touch the keys to switch through the screens.
- (2) Touch the [Card Shot] key.

6

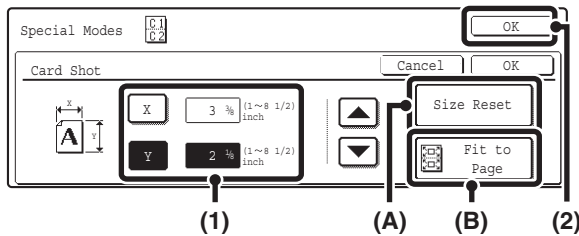

Specify the original size.

- (1) Enter the original size.

With the [X] key highlighted, enter the X (horizontal) dimension of the original with the keys. Touch the [Y] key and enter the Y (vertical) dimension of the original with the keys.

- (A) The [Size Reset] key can be pressed to return the horizontal and vertical dimensions to the values set in "Card Shot Settings" in the system settings (administrator).
- (B) To enlarge or reduce the images to fit the paper based on the entered original size, touch the [Fit to Page] key.

- (2) Touch the [OK] key.

You will return to the base screen of copy mode. "Extra" will appear in the original size display in the base screen.

7

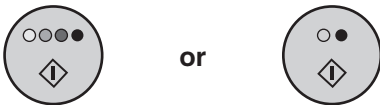

Press the [COLOR START] key (●●●●) or the [BLACK & WHITE START] key (○●) to scan the front of the card.



To cancel scanning...

Press the [STOP] key (⏹).

8

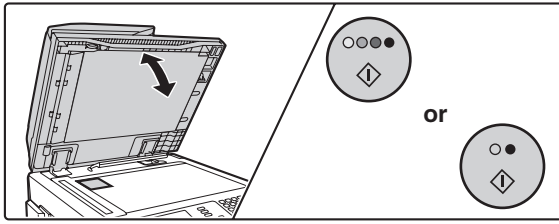

Press the [COLOR START] key (○●●●) or the [BLACK & WHITE START] key (○●) to scan the back of the card.

Use the same [START] key that you used for the front side of the card.



**To cancel scanning...**

Press the [STOP] key (Ⓢ).

9

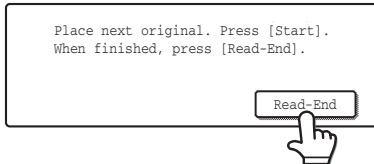

**Touch the [Read-End] key.**

Copying will begin.



**To cancel copying...**

Press the [STOP] key (Ⓢ).



- The original must be placed on the document glass.
- Copying is only possible on standard size paper.
- XY Zoom cannot be used when using this function.
- The image cannot be rotated when using this function.



**To cancel card shot...**

Touch the [Cancel] key in the screen of step 6.



**System Settings (Administrator): Card Shot Settings**

This is used to set the values to which the size returns when the [Size Reset] key is pressed. 1" to 8-1/2" (25 mm to 210 mm) can be entered for both the horizontal and vertical dimensions.

The factory default settings are 3-3/8" (86 mm) for X (the width) and 2-1/8" (54 mm) for Y (the height).

# PRINTING THE DATE AND A STAMP ON COPIES (Stamp)

Use this function to print the date, a stamp, the page number, and text on copies.

Six printing positions are available: top left, top center, top right, bottom left, bottom center, and bottom right.

The printing positions are separated into areas that are used for the date, page number and text (A below), and areas that are used for a stamp (B below).

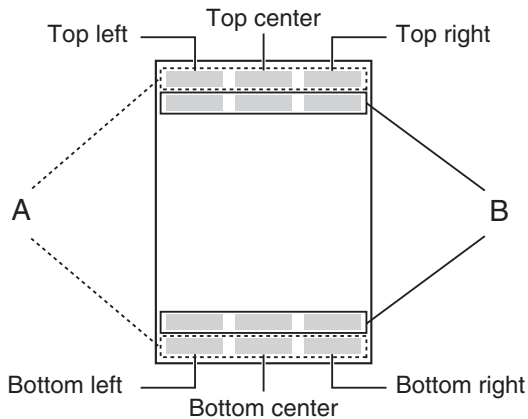

Stamp	Print area	Maximum number of positions
Date	A	1 position only
Stamp	B	6 positions
Page Numbering	A	1 position only
Text	A	6 positions

- In the event that one print item overlaps another print item, the order of placement will be as follows: item on the right side at the front, item on the left side behind the right item, item at the center behind the left item. Only the content that is at the front will be printed. Content that is hidden due to overlapping will not be printed.
- Text will be printed at the preset size regardless of the copy ratio or paper size setting.
- Text will be printed at the preset exposure regardless of the exposure setting.
- Depending on the size of the paper, some printed content may be cut off or shifted out of position.

## When used in combination with other special modes

When the Stamp is used in combination with other special modes, the special modes are reflected in the printed items.

Special Modes	Printing
Margin Shift	The printed item is shifted the amount of the margin width along with the image.
Dual Page Copy	The item is printed on each copy sheet.
Pamphlet Copy Book Copy	The item is printed on each page of the resulting pamphlet or book.
Multi Shot Card Shot	The item is printed on each copy sheet.
Covers/Inserts	Use the stamp to select whether or not the item is printed on inserted covers/inserts.

- When used in combination with "Erase", "Job Build", "Mirror Image", or "B/W Reverse", the item is printed in the set position as usual.

# ADDING THE DATE TO COPIES (Date)

The date can be printed on copies. The position of the date, color, format, and page (first page only or all pages) can be selected.

**Example: Printing AUG 1, 2005 in the top right corner of the paper.**

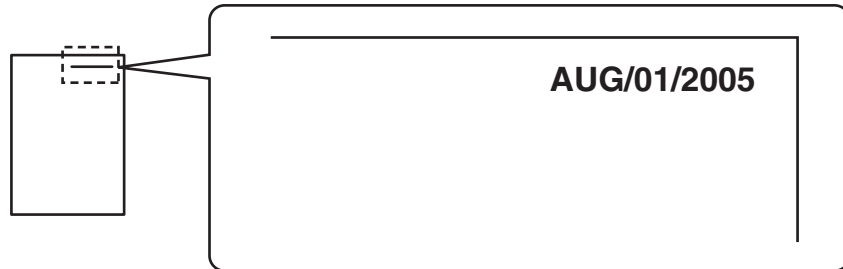

1

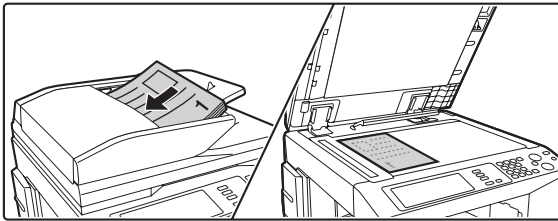

## Place the original.

Place the original face up in the document feeder tray, or face down on the document glass.

2

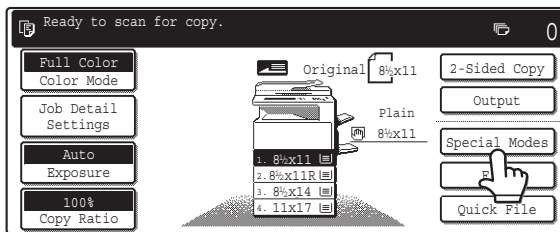

## Touch the [Special Modes] key.

3

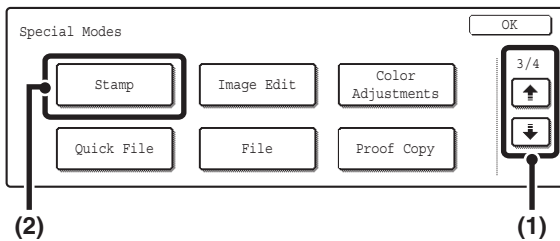

## Select Stamp.

(1) Touch the   keys to switch through the screens.

(2) Touch the [Stamp] key.

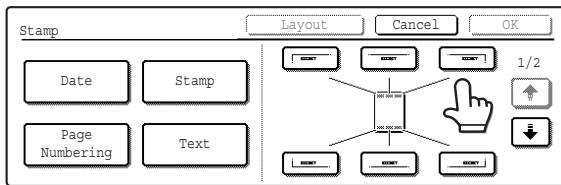

## Select the print position.

Select from 6 positions: top left, top center, top right, bottom left, bottom center, bottom right.

The keys that show the print positions will appear as follows depending on the state of the settings.

	Not selected, stamp setting has not been selected.
	Selected during selection of the stamp setting.
	Not selected, stamp setting has already been selected.

The above key is the top left key. The appearance of the keys varies by position.



- The "Date" cannot be set in a position that already has "Page Numbering" and "Text" settings.
- The "Date" cannot be set in multiple positions. If the "Date" has already been set and the [Date] key is touched at a different position, a message will appear asking you if you wish to move the date to the selected position. If you wish to move the date, touch the [Yes] key. If not, press the [No] key.
- If the "Date" is set without selecting a position, the date will be printed in the top right position.

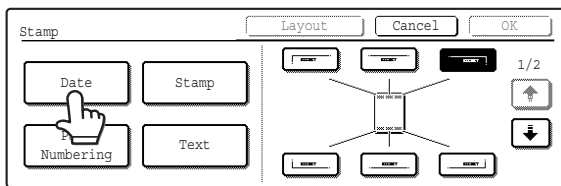

## Touch the [Date] key.

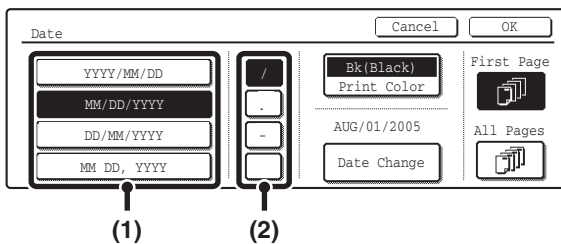

## Set the date format.

- (1) Touch the key that shows the desired date format.
- (2) If you selected [YYYY/MM/DD], [MM/DD/YYYY], or [DD/MM/YYYY], touch the [/], [.] , [-], or [ ] key to select the separator.



7

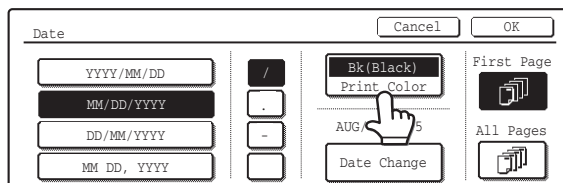

**Touch the [Print Color] key and select the print color.**

Touch the desired color and touch the [OK] key.

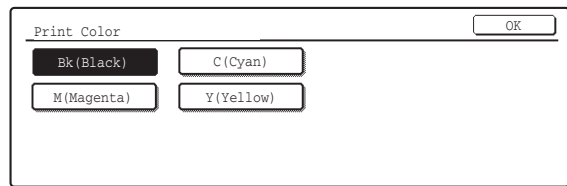

If you selected a color other than [Bk (Black)], press the [COLOR START] key (○●●●). Pressing the [BLACK & WHITE START] key (○●) will print the date in black and white.

8

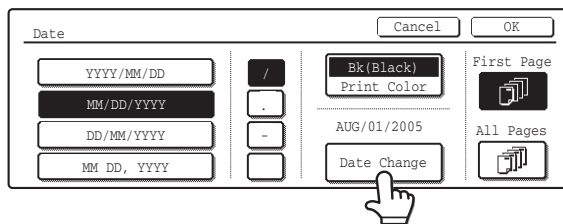

**Check the displayed date. If you need to change the date, touch the [Date Change] key.**

Set the date that you wish to use and touch the [OK] key.

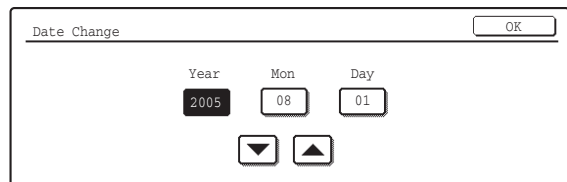

- If you select a date that does not exist (such as Feb. 30), the [OK] key will be grayed out to prevent entry.
- Changing the date here will not change the date that is set in the machine using "Clock" in the system settings.

9

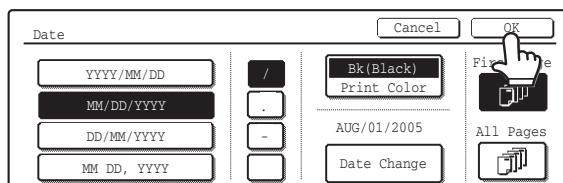

**Select the pages that the date will be printed on and touch the [OK] key.**

Select printing on the first page only, or printing on all pages.

10

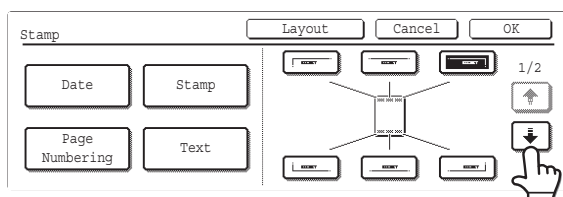

**Touch the [Original Orientation] key.**

11

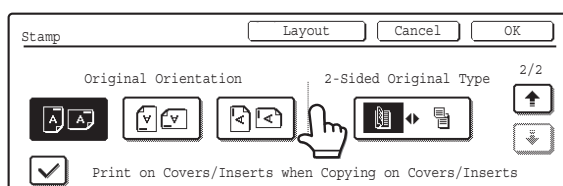

**Touch the [Original Orientation] key and specify the orientation of the placed original.**

If 2-sided originals have been placed, touch the [2-Sided Original Type] key and specify the binding position (booklet binding or tablet binding) of the originals.

12

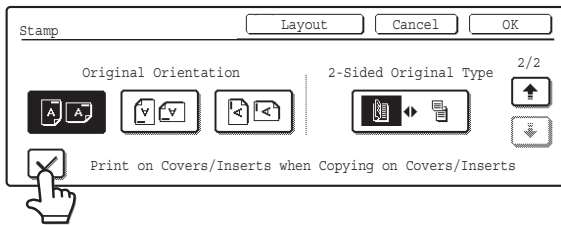

**If covers/inserts will be inserted, select whether or not you want the stamp printed on the covers/inserts.**

If not, touch the checkbox to remove the checkmark .



- When copying on covers/inserts is not selected, printing will not take place even if a checkmark appears.
- This setting cannot be selected if insertion of covers and inserts is disabled in the system settings (administrator).

13

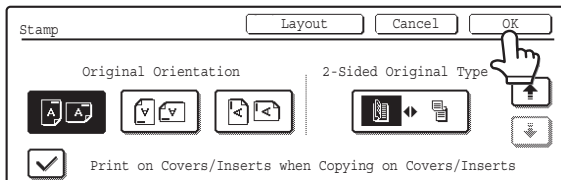

**Touch the [OK] key.**

You will return to the base screen of copy mode.

14

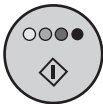

or



**Press the [COLOR START] key (○●●●) or the [BLACK & WHITE START] key (○●).**

Copying will begin.

- If the originals were placed in the document feeder tray, the originals are copied.
- If you are using the document glass, copy each page one page at a time.

If you are using the sort function or other function that requires all originals to be scanned before the copies are printed, you must use the same [START] key that you used to scan the first original to scan each of the remaining originals.



- If you selected printing in color, press the [COLOR START] key (○●●●). Even if color is selected, pressing the [BLACK & WHITE START] key (○●) will print the date in black and white.
- If the date is printed in color on a black and white copy, the copy will be included in the full color count.



**To cancel scanning of the original and copying...**

Press the [STOP] key (⏏).



**To cancel the stamp...**

Touch the [Cancel] key in the screen of step 4.

**To cancel the date print setting...**

Touch the [Cancel] key in the screen of step 6.

# STAMPING COPIES (Stamp)

Text such as "CONFIDENTIAL" can be printed in white on a dark background as a "Stamp" on copies. The position, color, size, density, and pages (first page only or all pages) can be selected for a stamp.

## Printing "CONFIDENTIAL" in the top left corner of a copy

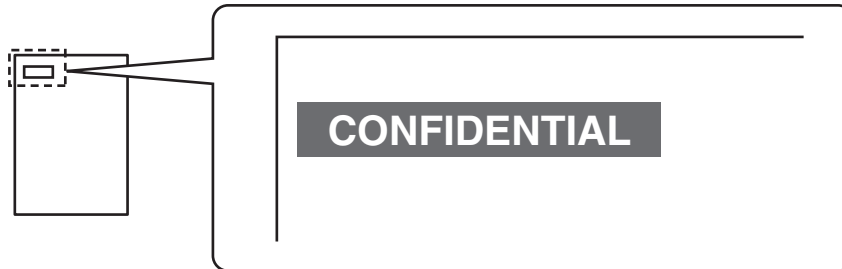

The following 12 selections are available for the stamp text.

CONFIDENTIAL	PRIORITY	PRELIMINARY	FINAL
FOR YOUR INFO.	DO NOT COPY	IMPORTANT	COPY
URGENT	DRAFT	TOP SECRET	PLEASE REPLY

3 levels can be selected for the density of the stamp background.

4 colors can be selected for the stamp color.

2 stamp sizes can be selected.

1

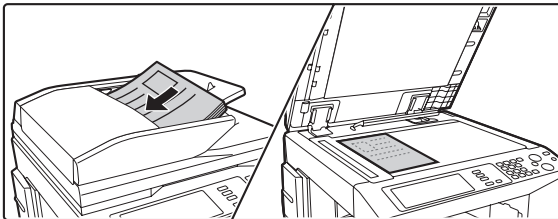

### Place the original.

Place the original face up in the document feeder tray, or face down on the document glass.

2

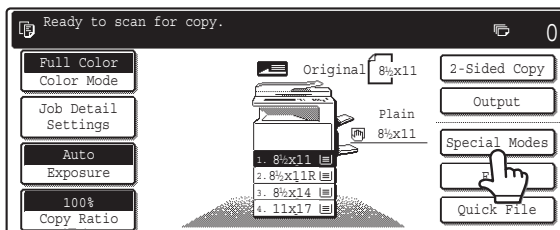

### Touch the [Special Modes] key.

3

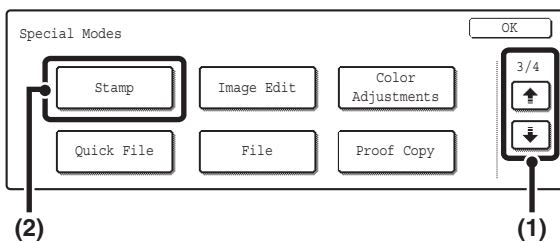

### Select Print Menu.

(1) Touch the keys to switch through the screens.

(2) Touch the [Print Menu] key.

4

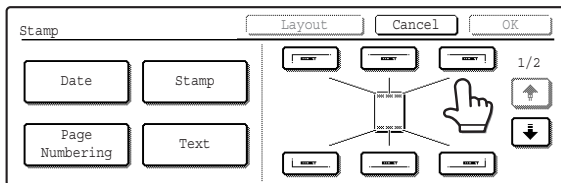

### Select the print position.

Select from 6 positions: top left, top center, top right, bottom left, bottom center, bottom right.

The keys that show the print positions will appear as follows depending on the state of the settings.

	Not selected, stamp setting has not been selected.
	Selected during selection of the stamp setting.
	Not selected, stamp setting has already been selected.

The above key is the top left key. The appearance of the keys varies by position.



If a "Stamp" is set without selecting a position, the stamp will be printed in the top left position.

5

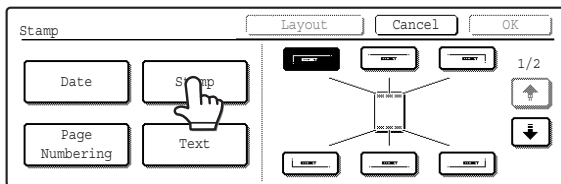

### Touch the [Stamp] key.

6

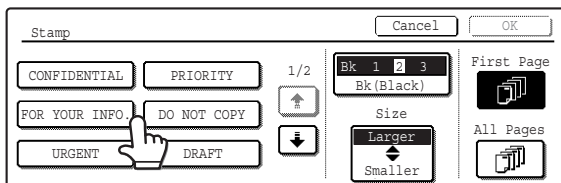

### Touch the key of the stamp that you wish to use.

7

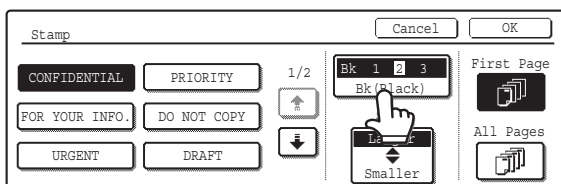

### Touch the [Print Color] key and set the color and density.

Touch the color that you wish to use.

If you wish to darken the selected color, touch the key.

If you wish to lighten the selected color, touch the key.

When you have finished the settings, touch the [OK] key.

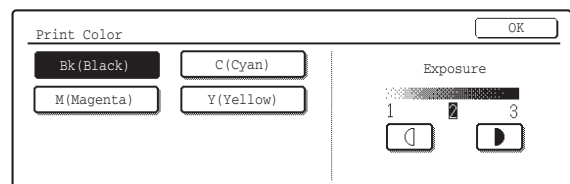

If you selected a color other than [Bk (Black)], press the [COLOR START] key (○●●●). Pressing the [BLACK & WHITE START] key (○●) will print the stamp in black and white.

8

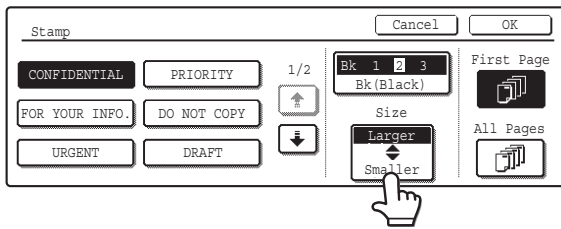

Touch the [Larger ◀ Smaller] key to select the size of the stamp.

9

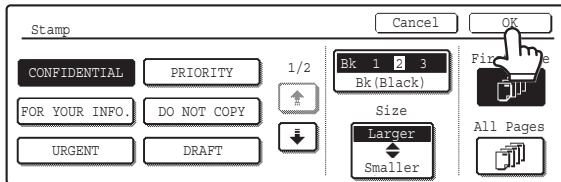

Select the pages that the stamp will be printed on and touch the [OK] key.  
Select printing on the first page only, or printing on all pages.

10

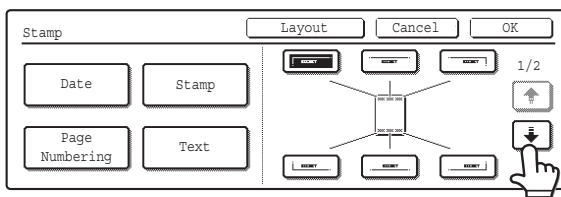

Touch the [Layout] key.

11

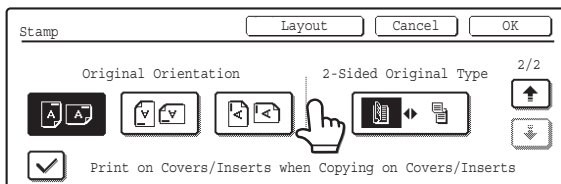

Touch the [Original Orientation] key and specify the orientation of the placed original.

If 2-sided originals have been placed, touch the [2-Sided Original Type] key and specify the binding position (booklet binding or tablet binding) of the originals.

12

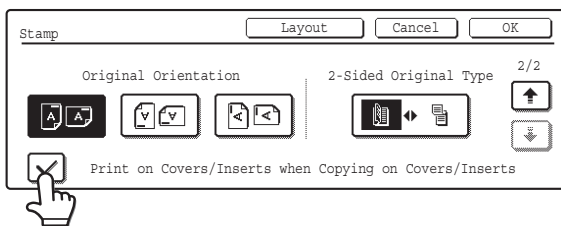

If covers/inserts will be inserted, select whether or not you want the stamp printed on the covers/inserts.

If not, touch the checkbox to remove the checkmark .



- When copying on covers/inserts is not selected, printing will not take place even if a checkmark appears.
- This setting cannot be selected if insertion of covers and inserts is disabled in the system settings (administrator).

13

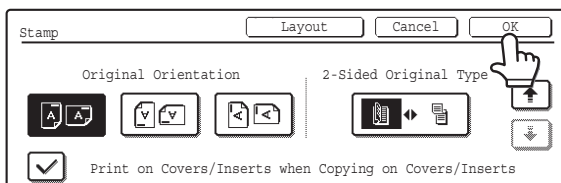

Touch the [OK] key.

You will return to the base screen of copy mode.

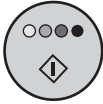

or



Press the [COLOR START] key (○●●●) or the [BLACK & WHITE START] key (○●).

Copying will begin.

- If the originals were placed in the document feeder tray, the originals are copied.
- If you are using the document glass, copy each page one page at a time.

If you are using the sort function or other function that requires all originals to be scanned before the copies are printed, you must use the same [START] key that you used to scan the first original to scan each of the remaining originals.



- If you selected printing in color, press the [COLOR START] key (○●●●). Even if color is selected, pressing the [BLACK & WHITE START] key (○●) will print the stamp in black and white.
- If the stamp is printed in color on a black and white copy, the copy will be included in the full color count.



**To cancel scanning of the original and copying...**

Press the [STOP] key (⏏).



The stamp text cannot be edited.



- **To cancel the stamp...**  
Touch the [Cancel] key in the screen of step 4.
- **To cancel the stamp setting...**  
Touch the [Cancel] key in the screen of step 6.

## PRINTING PAGE NUMBERS ON COPIES (Page Numbering)

Page numbers can be printed on copies.

The position, color, format, and page number can be selected for page numbering.

### Printing the page number at the bottom center of the paper.

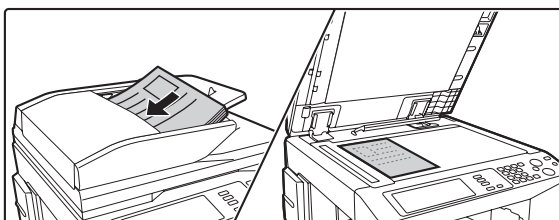
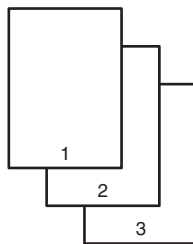

### Place the original.

Place the original face up in the document feeder tray, or face down on the document glass.

2

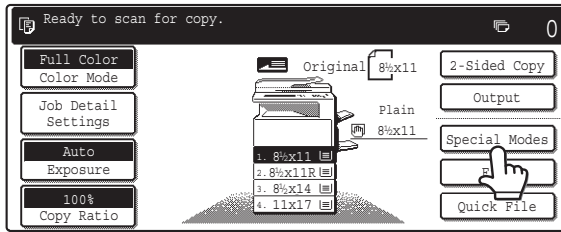

Touch the [Special Modes] key.

3

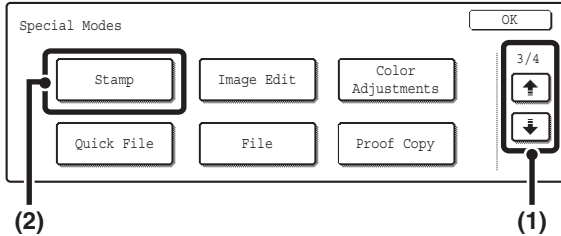

Select Stamp.

- (1) Touch the keys to switch through the screens.
- (2) Touch the [Stamp] key.

4

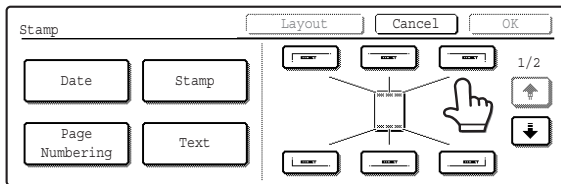

Select the print position.

Select from 6 positions: top left, top center, top right, bottom left, bottom center, bottom right.

The keys that show the print positions will appear as follows depending on the state of the settings.

	Not selected, stamp setting has not been selected.
	Selected during selection of the stamp setting.
	Not selected, stamp setting has already been selected.

The above key is the top left key. The appearance of the keys varies by position.



- "Page Numbering" cannot be configured in a position that already has "Date" and "Text" settings.
- "Page Numbering" cannot be selected in multiple positions. If the [Page Numbering] key is touched when Page Numbering has already been set, a message will appear asking you if you wish to move the page numbers to the selected position. If you wish to move the page numbers, touch the [Yes] key. If not, press the [No] key.
- If "Page Numbering" is set without selecting a position, the page numbers will be printed in the bottom center position.

5

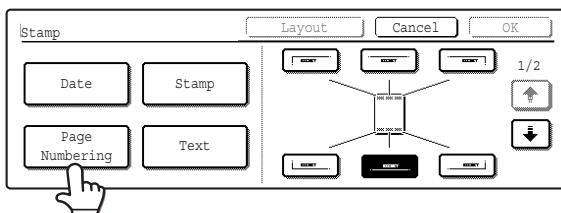

Touch the [Page Numbering] key.

6

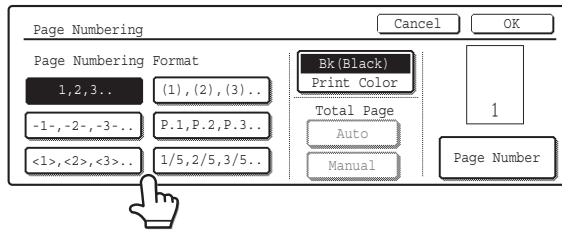

## Select a format for the page number.

If "1/5, 2/5, 3/5" is selected,

"Page number / Total pages" will be printed. "Auto" is initially selected for the total pages, which means that the number of scanned original pages is automatically set as the total pages. If you need to set the total pages manually, such as when a large number of originals are divided into sets for scanning, touch the [Manual] key to display the total pages entry screen.

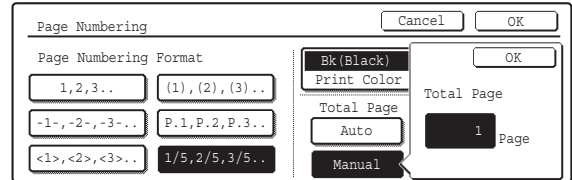

Enter the total pages (1 to 999) with the numeric keys and touch the [OK] key.



- When 2-sided copying is performed, the total pages is the total number of sides of the paper. If the final page is blank, it is not counted. However, if a back cover will be added and the [Count Back Cover] checkbox is selected , the final page is counted. (See step 11.)
- When used in combination with "Dual Page Copy", "Multi Shot", or "Card Shot", the number of sides of the paper copied on is the total pages.
- When used in combination with "Pamphlet Copy" or "Book Copy", the total number of pages in the resulting pamphlet or booklet is the total pages.

7

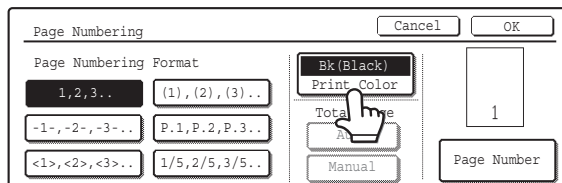

## Touch the [Print Color] key.

Touch the color that you wish to use.  
Touch the [OK] key.

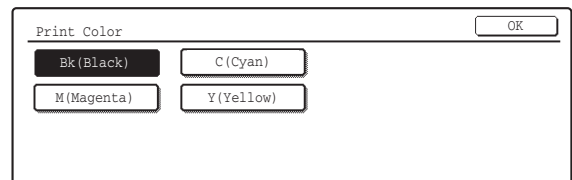

If you selected a color other than [Bk (Black)], press the [COLOR START] key (○●●●). Pressing the [BLACK & WHITE START] key (○●) will print the page numbers in black and white.

8

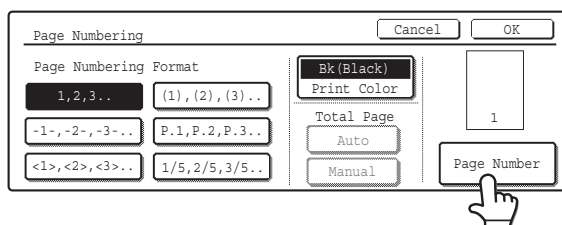

To change the first number or last number of page numbering, the page from which printing begins, or the insert printing setting, touch the [Page Number] key.



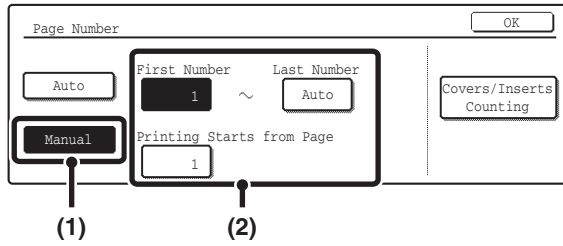

## Select page number settings.

- (1) Touch the [Manual] key.
- (2) Set the first number, the last number, and the "Printing Starts from Page" number.

Touch each key and enter a number with the numeric keys. (1 to 999)

The [CLEAR] key ( $\square$ ) can be pressed to return the setting of the selected item to the default value. If you make a mistake, press the [CLEAR] key ( $\square$ ) and then enter the correct number.



- A last number smaller than the first number cannot be set.
- The "Last Number" is initially set to "Auto", which means that page numbers are automatically printed through the last page based on the "First Number" and "Printing Start from Page" settings.
- If the last number is set to a smaller number than the total pages, page numbers are not printed on pages after the page set as the last number.
- Set a page number in "Printing Starts from Page". For example, if "3" is set and one-sided copying is being performed, page numbers will be printed beginning from the 3rd copy sheet (the 3rd original page). If two-sided copying is being performed, page numbers will be printed beginning from the front side of the 2nd copy sheet (the 3rd original page).

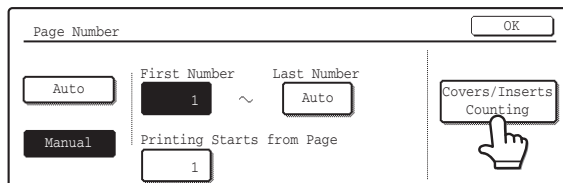

If covers/inserts will be inserted, touch the [Covers/Inserts Counting] key if you want the covers/inserts to be counted in the page numbers.

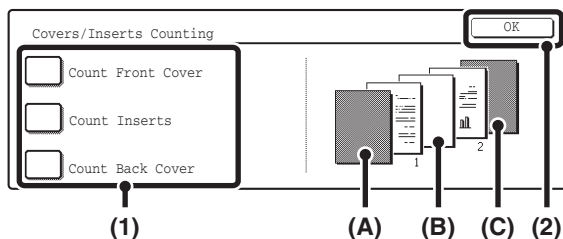

Touch each item that you want counted in the page numbers so that a checkmark appears , and then touch the [OK] key.

Items with a checkmark  will be reflected in the print image on the right side of the screen.

- (A): Front cover image  
 (B): Insert image  
 (C): Back cover image



- When the checkboxes are selected , each inserted sheet of paper (front cover, insert, or back cover) will be counted as one page in the case of 1-sided copying, or two pages in the case of 2-sided copying. However, when the body sheets are 1-sided copies and the inserted sheets are 2-sided copies, each body sheet is counted as one page and each inserted sheet is counted as 2 pages.
- Page numbers are printed on covers/inserts if the covers/inserts are counted and if they are copied on.

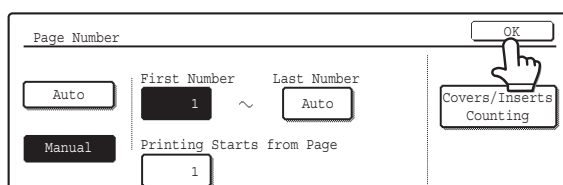

Touch the [OK] key.

13

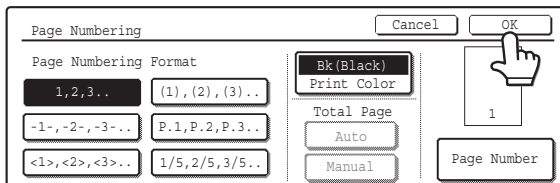

Touch the [OK] key.

14

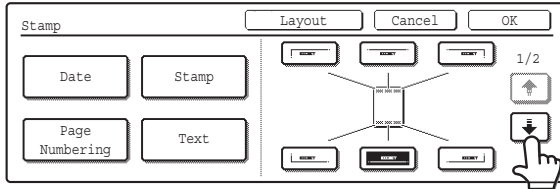

Touch the  key.

15

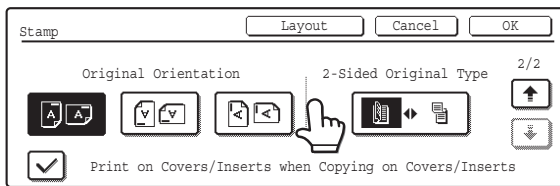

Touch the [Original Orientation] key and specify the orientation of the placed original.

If 2-sided originals have been placed, touch the  key and specify the binding position (booklet binding or tablet binding) of the originals.

16

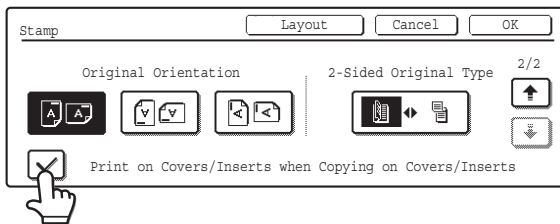

If covers/inserts will be inserted, select whether or not you want the text printed on the covers/inserts.

If not, touch the checkbox to remove the checkmark .



- When copying on covers/inserts is not selected, printing will not take place even if a checkmark appears.
- Page numbers are never printed on front and back covers, regardless of this setting.
- This setting cannot be selected if insertion of covers and inserts is disabled in the system settings (administrator).

17

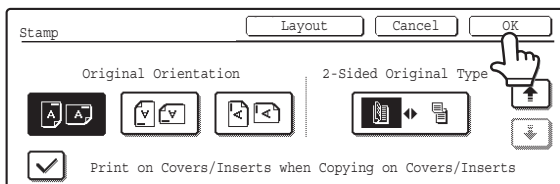

Touch the [OK] key.

You will return to the base screen of copy mode.

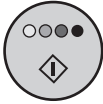

or



Press the [COLOR START] key (○●●●) or the [BLACK & WHITE START] key (○●).

Copying will begin.

- If the originals were placed in the document feeder tray, the originals are copied.
- If you are using the document glass, copy each page one page at a time.

If you are using the sort function or other function that requires all originals to be scanned before the copies are printed, you must use the same [START] key that you used to scan the first original to scan each of the remaining originals.



- If you selected printing in color, press the [COLOR START] key (○●●●). Even if color is selected, pressing the [BLACK & WHITE START] key (○●) will print the page numbers in black and white.
- If page numbers are printed in color on black and white copies, the copies will be included in the full color count.



**To cancel scanning of the original and copying...**

Press the [STOP] key (⏹).



- When "Page Numbering" is selected, copying in group mode is not possible. The mode automatically changes to sort mode.
- When the page number printing position is set to the right side or left side and pamphlet copy or book copy is used, the print position is changed so that the page numbers always appear on the outer side of each opened page (the left and right sides of the opened pages). If a stamp is set in the area where page numbering is set, the position of the stamp changes together with the page number.

If another print item is set in this changing position, the page numbers will alternate sides with the stamp.

A stamp item that is in a position not affected by the changing page number position will be printed in its set position.

Example: When four pages are copied using pamphlet copy and the page number format is "1, 2, 3...", the result is as follows:

In this example, the page number is set at the bottom of the page and the date is set at the top, and thus the date does not move.

**Print settings**

Date	
Stamp No.	Text



**Side 1**

AUG/01/2005	AUG/01/2005
CONFIDENTIAL	CONFIDENTIAL
4 AAA	AAA 1

**Side 2**

AUG/01/2005	AUG/01/2005
CONFIDENTIAL	CONFIDENTIAL
2 AAA	AAA 3



- **To cancel the stamp...**  
Touch the [Cancel] key in the screen of step 4.
- **To cancel the page numbering setting...**  
Touch the [Cancel] key in the screen of step 6.

# PRINTING TEXT ON COPIES (Text)

Entered text can be printed on copies. A maximum of 50 characters can be printed.  
Up to 30 frequently used text strings can be stored.

**Example: Printing "August 2005 Planning Meeting" in the top left corner of the paper**

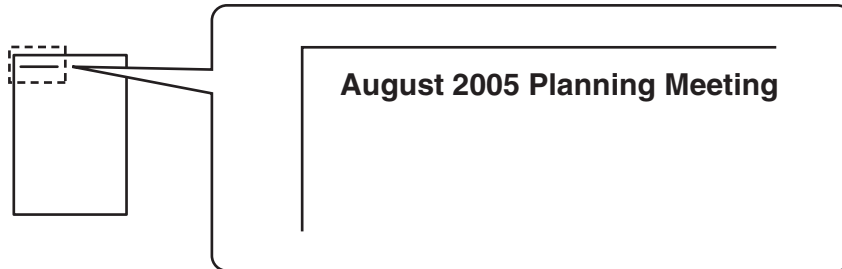

1

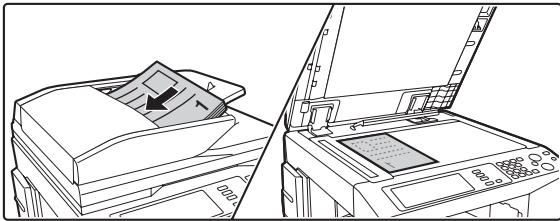

## Place the original.

Place the original face up in the document feeder tray, or face down on the document glass.

2

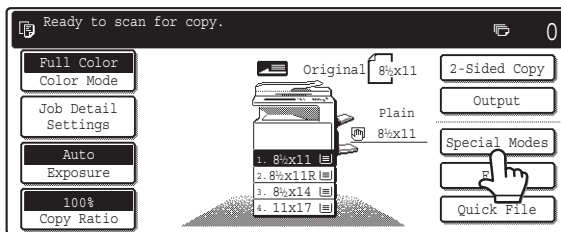

## Touch the [Special Modes] key.

3

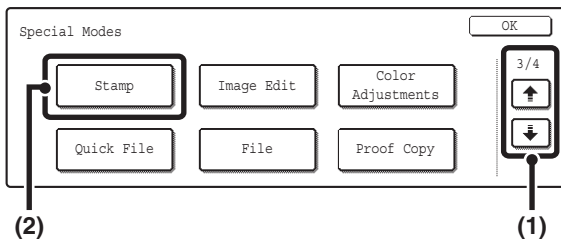

## Select Stamp.

(1) Touch the   keys to switch through the screens.

(2) Touch the [Stamp] key.

4

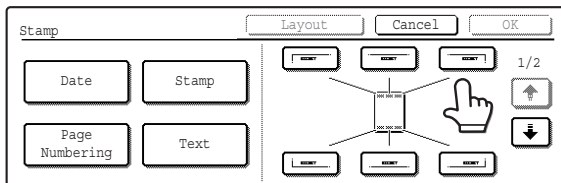

## Select the print position.

Select from 6 positions: Top left, top center, top right, bottom left, bottom center, bottom right. The touched key is highlighted.

The keys that show the print positions will appear as follows depending on the state of the settings.

	Not selected, stamp setting has not been selected.
	Selected during selection of the stamp setting.
	Not selected, stamp setting has already been selected.

The above key is the top left key. The appearance of the keys varies by position.



- "Text" cannot be configured in a position that already has "Date" and "Page Numbering" settings.
- If "Text" is configured without selecting a position, the text will be printed in the top left position.

5

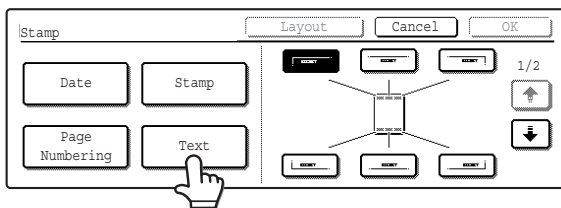

## Touch the [Text] key.

6

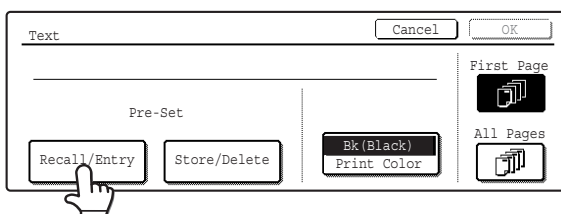

## Touch the [Recall/Entry] key.

To store or delete a text string, touch the [Store/Delete] key.  
[Storing, editing, and deleting text strings](#) (page 120)

7

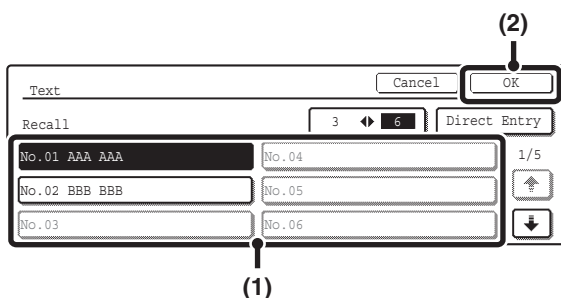

## Specify the text to be printed.

The [Direct Entry] key can be touched to display the text entry screen. To enter text, see "6. ENTERING TEXT" in the User's Guide. When all characters have been entered, touch the [OK] key.

### (1) Touch the text string that you wish to select.

The [3 ◀ 6] key can be touched to switch between 3-item display and 6-item display. When 3-item display is selected, the entire text string appears in each key.

### (2) Touch the [OK] key.

8

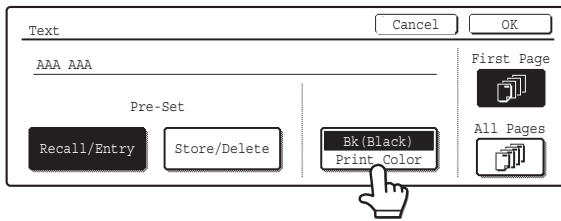

## Touch the [Print Color] key.

Touch the color that you wish to use. Touch the [OK] key.

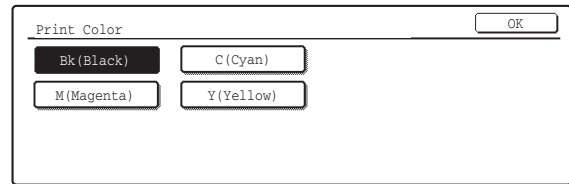

If you selected a color other than [Bk (Black)], press the [COLOR START] key (○●●●). Pressing the [BLACK & WHITE START] key (○●) will print the text in black and white.

9

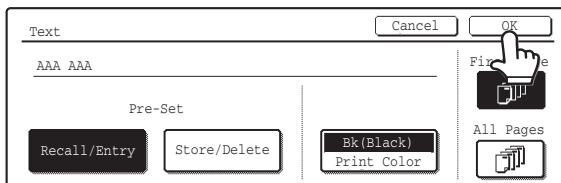

## Select the pages that the text will be printed on and touch the [OK] key.

Select printing on the first page only, or printing on all pages.

10

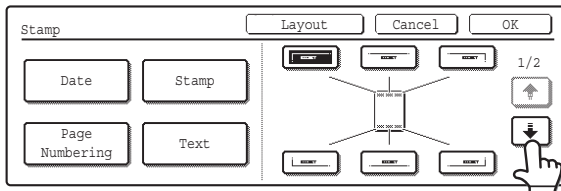

## Touch the key.

11

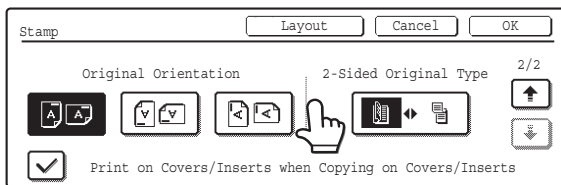

## Touch the [Original Orientation] key and specify the orientation of the placed original.

If 2-sided originals have been placed, touch the  key and specify the binding position (booklet binding or tablet binding) of the originals.

12

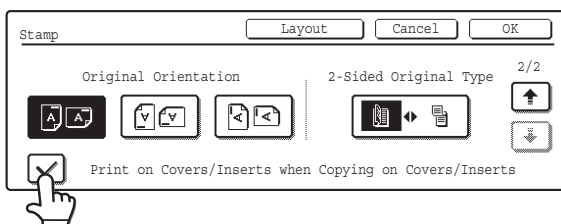

## If covers/inserts will be inserted, select whether or not you want the text printed on the covers/inserts.

If not, touch the checkbox to remove the checkmark .



- When copying on covers/inserts is not selected, printing will not take place even if a checkmark appears.
- This setting cannot be selected if insertion of covers and inserts is disabled in the system settings (administrator).

13

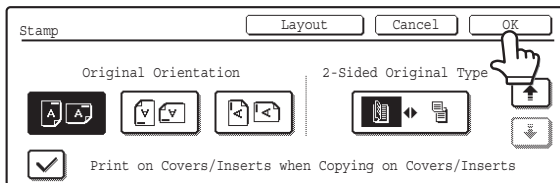

## Touch the [OK] key.

You will return to the base screen of copy mode.

14



or



## Press the [COLOR START] key (●●●●) or the [BLACK & WHITE START] key (●●).

Copying will begin.

- If the originals were placed in the document feeder tray, the originals are copied.
- If you are using the document glass, copy each page one page at a time.

If you are using the sort function or other function that requires all originals to be scanned before the copies are printed, you must use the same [START] key that you used to scan the first original to scan each of the remaining originals.



- If you selected printing in color, press the [COLOR START] key (●●●●). Even if color is selected, pressing the [BLACK & WHITE START] key (●●) will print the text in black and white.
- If the text is printed in color on a black and white copies, the copies will be included in the full color count.



### To cancel scanning of the original and copying...

Press the [STOP] key (⏏).



Text settings can also be configured in the Web pages. Click [Application Settings], [Copy Settings] and then [Text Settings (Stamp)] in the Web page menu.



### • To cancel the stamp...

Touch the [Cancel] key in the screen of step 4.

### • To cancel the text setting...

Touch the [Cancel] key in the screen of step 6.

# Storing, editing, and deleting text strings

**1**

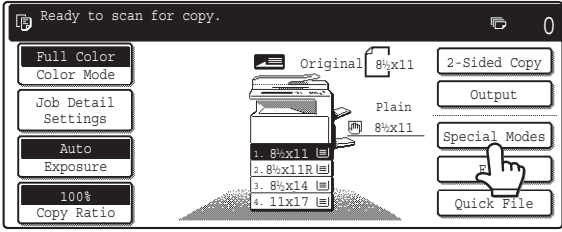

Ready to scan for copy.

Full Color Color Mode

Job Detail Settings

Auto Exposure

100% Copy Ratio

Original 8 1/2 x 11

Plain 8 1/2 x 11

2-Sided Copy

Output

Special Modes

Quick File

1. 8 1/2 x 11

2. 8 1/2 x 11 R

3. 8 1/2 x 14

4. 11 x 17

Touch the [Special Modes] key.

**2**

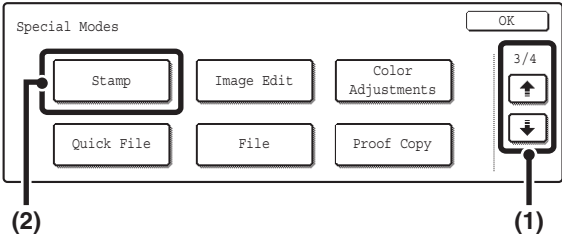

Special Modes

Stamp

Image Edit

Color Adjustments

Quick File

File

Proof Copy

OK

3/4

(2)

(1)

Select Stamp.

(1) Touch the   keys to switch through the screens.

(2) Touch the [Stamp] key.

**3**

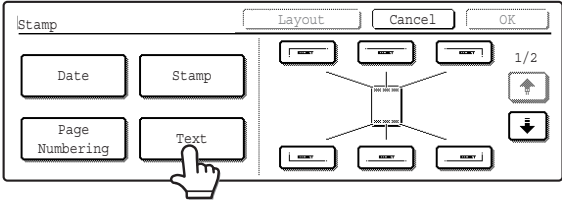

Stamp

Date

Stamp

Page Numbering

Text

Layout

Cancel

OK

1/2

Touch the [Text] key.

**4**



Text

Pre-Set

Recall/Entry

Store/Delete

Bk (Black) Print Color

First Page

All Pages

Cancel

OK

Touch the [Store/Delete] key.



## Store a text string, or edit/delete a stored text string.

### ● Storing a text string

#### (1) Touch a key that has not been stored.

A text entry screen appears. Enter the text string (maximum of 50 characters). To enter text, see "6. ENTERING TEXT" in the User's Guide. When you have finished entering the text, touch the [OK] key. The text entry screen will close.

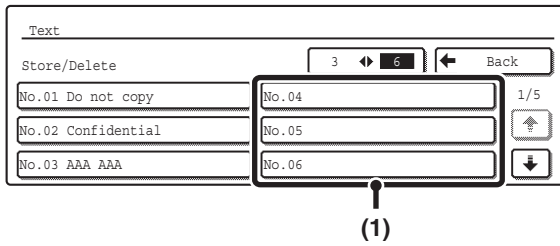

### ● Editing/deleting a text string

#### (1) Touch the key that has the text that you wish to edit or delete.

#### (2) To edit the text, touch the [Modify] key. To delete the text, touch the [Delete] key.

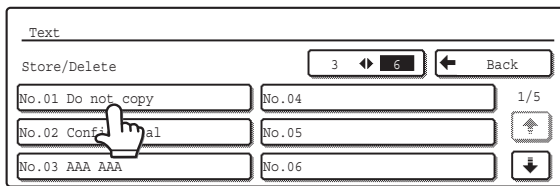

When the [Modify] key is touched, a text entry screen appears. The selected text string is entered in the screen. To enter text, see "6. ENTERING TEXT" in the User's Guide. When you have finished editing the text, touch the [OK] key. The text entry screen will close.



Text settings can also be configured in the Web pages. Click [Application Settings], [Copy Settings] and then [Text Settings (Stamp)] in the Web page menu.

# CHECKING THE STAMP LAYOUT (Layout)

After stamp items have been selected, you can check the print layout, change the print position, and delete print items.

1

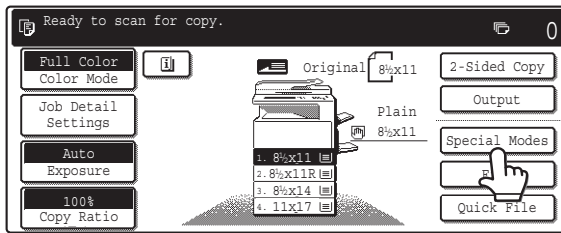

Touch the [Special Modes] key.

2

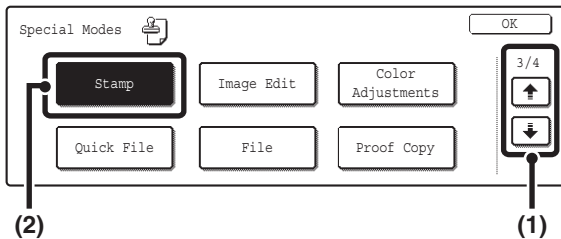

Select Stamp.

(1) Touch the keys to switch through the screens.

(2) Touch the [Print Menu] key.

3

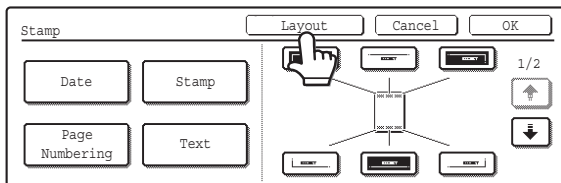

Touch the [Layout] key.

If the layout is correct, touch the [OK] key.



The [Layout] key can only be touched when stamp items have been selected.

4

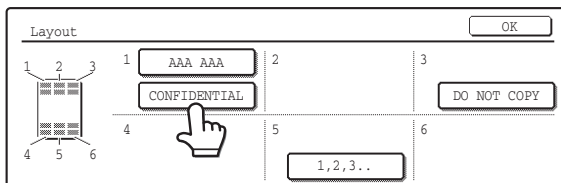

Touch the key of the print item that you want to delete or whose position you want to change.



A maximum of 14 characters appear in each key.

5



To change the position of the print item, touch the [Move] key. To delete the item, touch the [Delete] key.

If the [Move] key is touched, a screen for selecting the destination position appears.

If the [Delete] key is touched, the print item is deleted. (Go to step 8.)

6

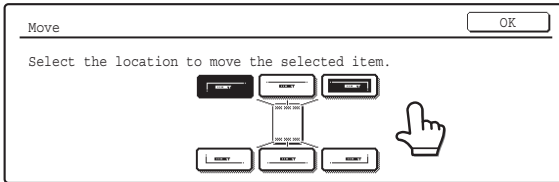

**Touch the key of the desired destination position.**

The touched position key is highlighted and the print position changes.

The keys that show the print positions will appear as follows depending on the state of the settings.

	Not selected, stamp setting has not been selected.
	Selected during selection of the stamp setting.
	Not selected, stamp setting has already been selected.

The above key is the top left key. The appearance of the keys varies by position.



If you wish to swap the position of the selected print item with the position of another print item, temporarily move either one of the print items to an unoccupied position and then switch the print positions.

7

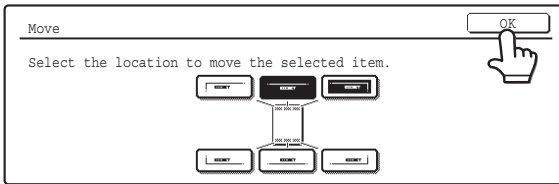

**Touch the [OK] key.**

If you attempt to move the print item to a position that is already occupied by another print item, a message will appear asking you if you wish to overwrite the other print item. To overwrite the other print item, touch the [Yes] key. To cancel the move, touch the [No] key.

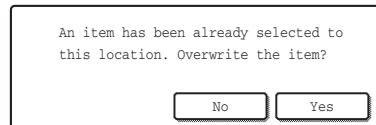

8

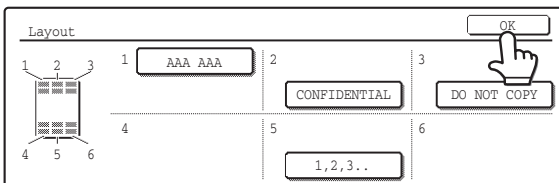

**Touch the [OK] key.**

9

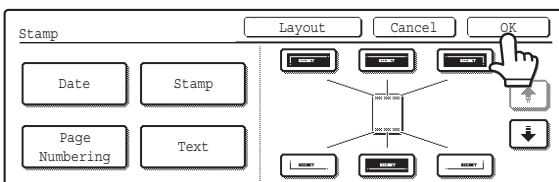

**Touch the [OK] key.**

# REPEATING PHOTOS ON A COPY

## (Photo Repeat)

Photo Repeat is used to create repeated images of a photo-size original (3" x 5" size, 5" x 7" size, 2-1/2" x 4" size or 2-1/2" x 2-1/2" size or 2-1/8" x 3-5/8" size (130 x 90 mm size, 100 x 150 mm size, 70 x 100 mm size, 65 x 70 mm size or 57 x 100 mm size)) on a single sheet of copy paper as shown below. Up to 24 images (when the image is 2-1/2" x 2-1/2" size (65 x 70 mm size)) can be repeated on a single sheet of paper.

• **Original size (to 3" x 5" (130 x 90 mm))**

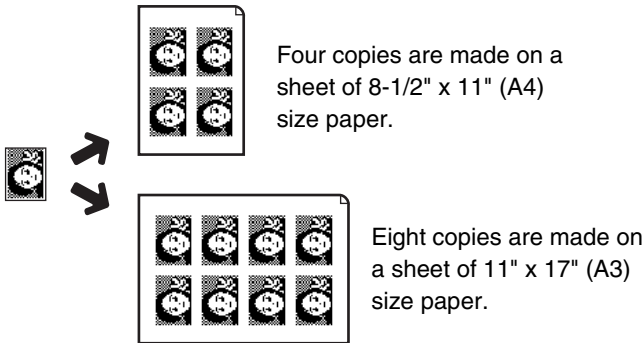

• **Original size (to 5" x 7" (100 x 150 mm))**

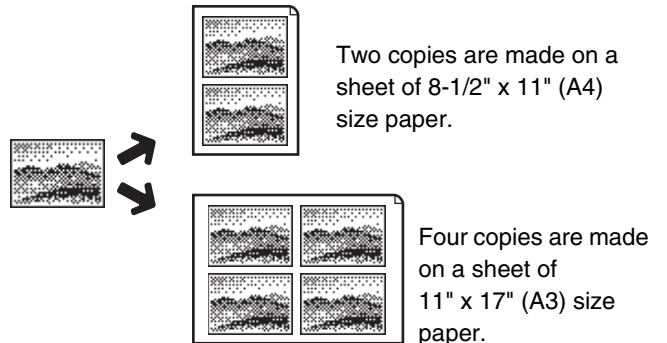

• **Original size (to 2-1/2" x 4" (70 x 100 mm))**

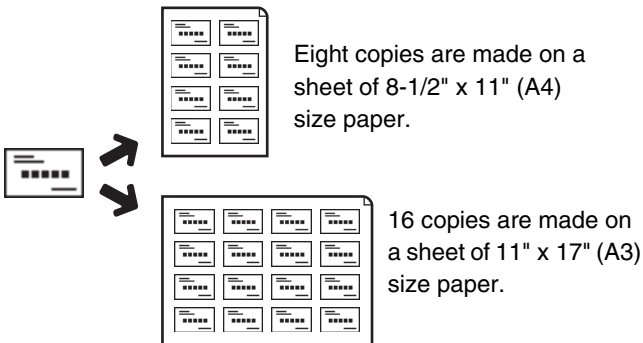

• **Original size (to 2-1/2" x 2-1/2" (65 x 70 mm))**

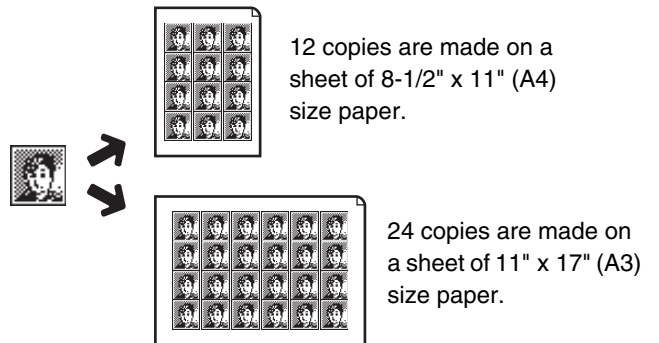

• **Original size (to 2-1/8" x 3-5/8" (57 x 100 mm))**

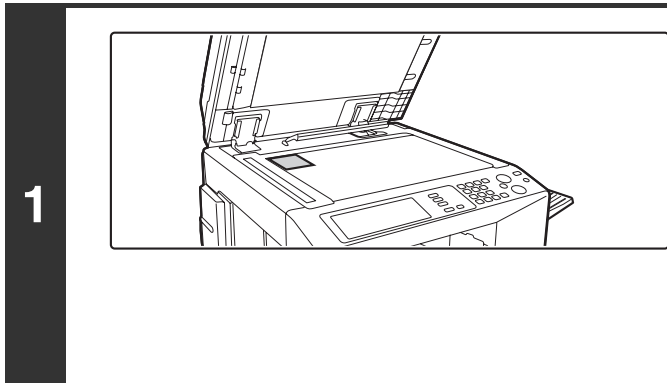
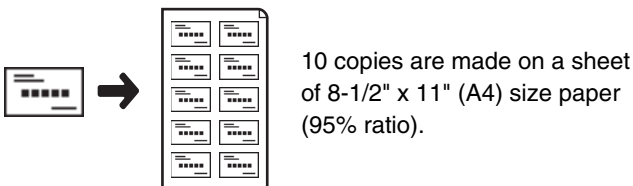

**Place the original face down on the document glass.**

- When placing an 3" x 5", 5" x 7", 2-1/2" x 4", 2-1/2" x 2-1/2" or 2-1/8" x 3-5/8" (130 x 90 mm, 100 x 150 mm, 70 x 100 mm, 65 x 70 mm or 57 x 100 mm) photo size original, place the original with the long side aligned against the left side of the document glass.
- When placing a business card size original, place the original with the long side aligned against the far side of the document glass.

2

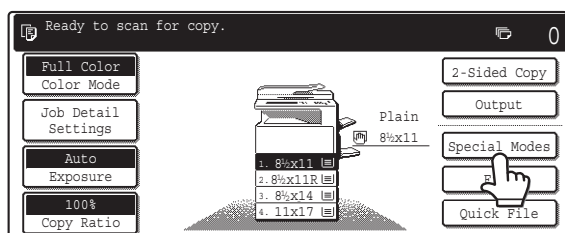

Touch the [Special Modes] key.

3

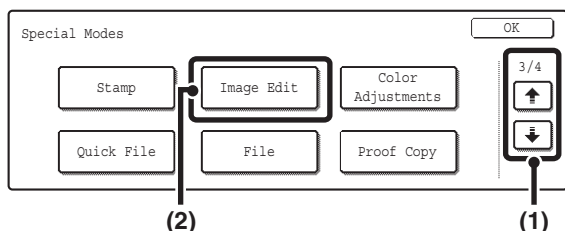

Select Image Edit.

(1) Touch the keys to switch through the screens.

(2) Touch the [Image Edit] key.

4

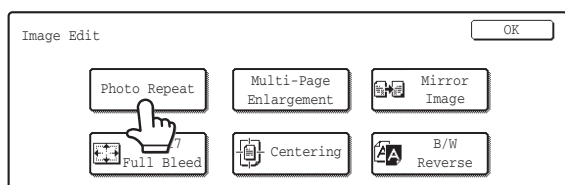

Touch the [Photo Repeat] key.

5

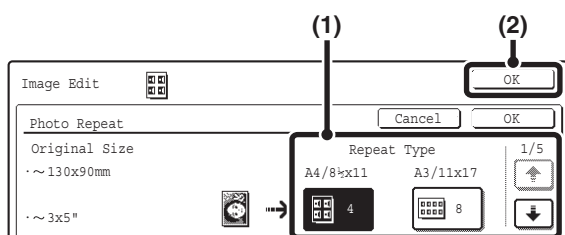

(1) Touch the key showing the original type and paper size combination that you wish use.

Touch the keys to switch through the screens and touch the desired repeat type key (8-1/2" x 11" or 11" x 17") (A4 or A3).

(2) Touch the [OK] key.

When the [OK] key is touched, you will return to the special mode screen. Touch the [OK] key to return to the base screen of the copy mode.



When making repeat copies of a business card size original (up to 2-1/8" x 3-5/8" (57 x 100 mm)), only 8-1/2" x 11" (A4) can be selected for the paper size.

6

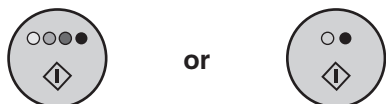

Press the [COLOR START] key (●●●●) or the [BLACK & WHITE START] key (●●).

Copying of the original on the document glass begins.

If you are using the sort function or other function that requires all originals to be scanned before the copies are printed, you must use the same [START] key that you used to scan the first original to scan each of the remaining originals.



To cancel scanning of the original and copying...

Press the [STOP] key (⊘).



- The original must be placed on the document glass.
- Only 8-1/2" x 11" (A4) or 11" x 17" (A3) size paper can be used.
- The copy ratio is 100% when this function is used. (The ratio cannot be changed.) However, for a business card size original (up to 2-1/8" x 3-5/8" (57 x 100 mm)), the images are reduced to 95%.



**To cancel the photo repeat setting...**

Touch the [Cancel] key in the screen of step 5.

# CREATING A LARGE POSTER (Multi-Page Enlargement)

This function is used to enlarge an image of an original and print it as a composite image using multiple sheets of paper.

Original (8-1/2" x 11" (A4) size)

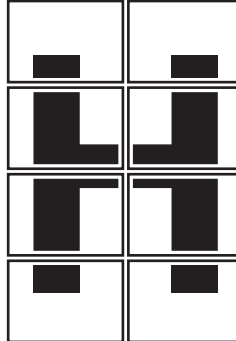

Copy (enlarged image on 8 sheets of 11" x 17" (A3) paper)

1

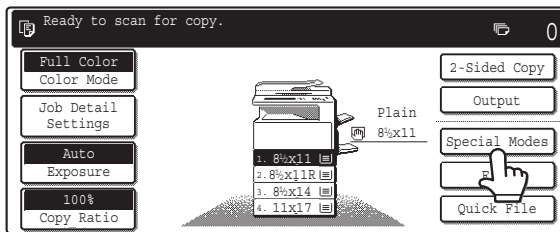

Touch the [Special Modes] key.

2

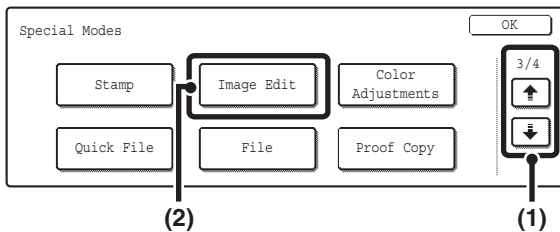

Select Image Edit.

- (1) Touch the keys to switch through the screens.
- (2) Touch the [Image Edit] key.

3

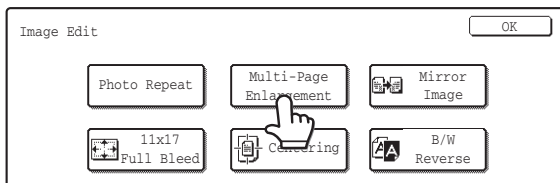

Touch the [Multi-Page Enlargement] key.

### Inch sizes

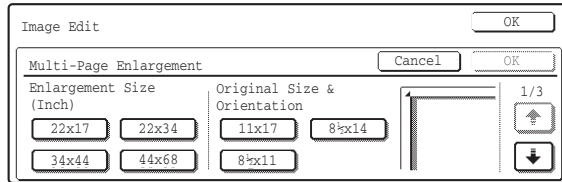

### A sizes

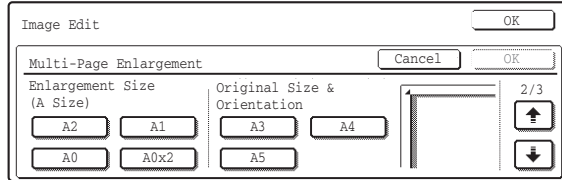

### B sizes

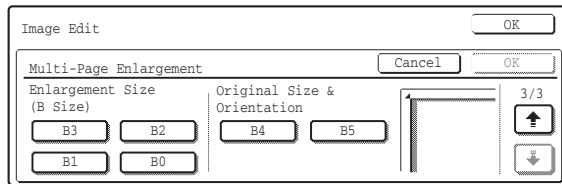

## Select the size system that you wish to use for multi-page enlargement.

Touch the keys to display the screen that shows the desired group of sizes.

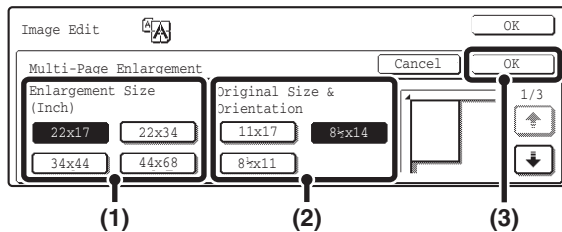

## Set the enlargement size and the original size.

- (1) Select the enlargement size.
- (2) Select the size of the original to be used.

A suitable original placement orientation and the number of sheets of paper required for the enlarged image are displayed based on the selected original size and enlargement size. Check the placement orientation and the number of sheets of paper to be used for the enlarged image.

- (3) Touch the [OK] key.

The following combinations of original sizes and enlargement sizes are possible for multi-page enlargement.

Enlargement size ↔ Original size	
Inch system	22" x 17" ↔ 11" x 17", 8-1/2" x 14", 8-1/2" x 11"
	22" x 34" ↔ 11" x 17", 8-1/2" x 14", 8-1/2" x 11"
	34" x 44" ↔ 11" x 17", 8-1/2" x 14", 8-1/2" x 11"
	44" x 68" ↔ 11" x 17"
A system	A2 ↔ A3, A4, A5
	A1 ↔ A3, A4, A5
	A0 ↔ A3, A4
	A0 x 2* ↔ A3
B system	B3 ↔ B4, B5
	B2 ↔ B4, B5
	B1 ↔ B4, B5
	B0 ↔ B4

\* The size that is twice A0 size.



An A size original cannot be enlarged to a B size, and a B size original cannot be enlarged to an A size.



6

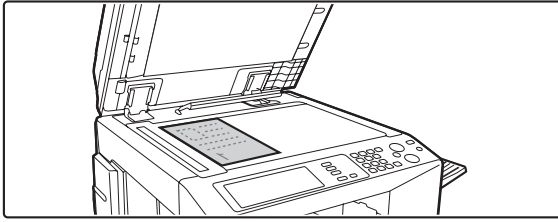

Place the original face down on the document glass in the orientation indicated in the screen.

7

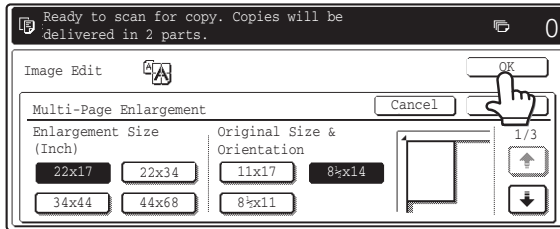

Touch the [OK] key.

When the [OK] key is touched, you will return to the special mode screen. Touch the [OK] key to return to the base screen of the copy mode.

8

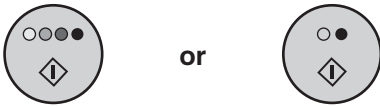

Press the [COLOR START] key (○●●●) or the [BLACK & WHITE START] key (○●).

Copying of the original on the document glass begins. If you are using the sort function or other function that requires all originals to be scanned before the copies are printed, you must use the same [START] key that you used to scan the first original to scan each of the remaining originals.



**To cancel scanning of the original and copying...**

Press the [STOP] key (⏹).



- Overlap of sections of image
  - There will be a margin around the edges of each copy.
  - Areas for overlapping the copies will be created at the leading and trailing edges of each copy.
- If an original size is selected first, a message will appear indicating the enlargement sizes that can be selected. If an enlargement size is selected first, a message will appear indicating the original sizes that can be selected.
- If a combination of settings is selected for which multi-page enlargement is not possible, invalid selection beeps will sound.
- The paper size, number of sheets required for the enlarged image, and the ratio are automatically selected based on the selected original size and enlargement size. (The paper size and ratio cannot be selected manually.)
- If no paper trays have the size of paper that was automatically selected, "Load XXX paper" will appear. Change the paper in one of the trays or the bypass tray to the indicated size of paper.
- The original must be placed on the document glass.



**To cancel the multi-page enlargement setting...**

Touch the [Cancel] key in the screen of step 5.

# INVERTING THE IMAGE (Mirror Image)

This feature is used to make a copy that is a mirror image of the original.

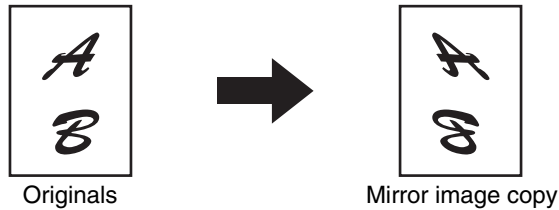

Originals

Mirror image copy

1

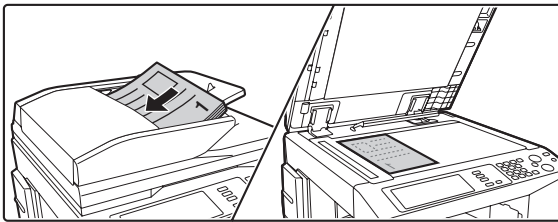

## Place the original.

Place the original face up in the document feeder tray, or face down on the document glass.

2

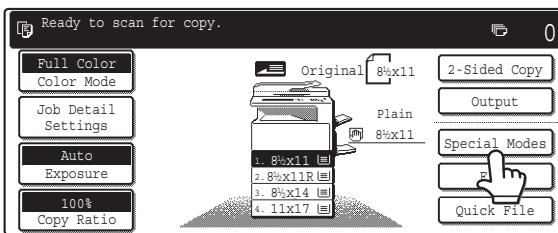

## Touch the [Special Modes] key.

3

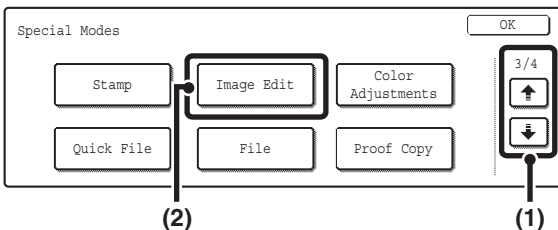

## Select Image Edit.

- (1) Touch the   keys to switch through the screens.
- (2) Touch the [Image Edit] key.

4

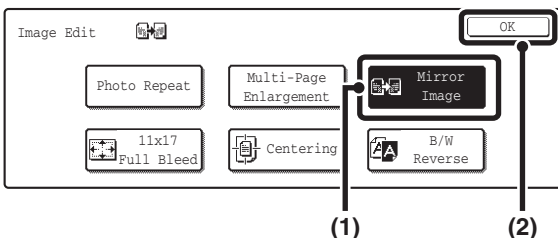

## Select Mirror Image.

- (1) Touch the [Mirror Image] key so that it is highlighted.
- (2) Touch the [OK] key.

When the [OK] key is touched, you will return to the special mode screen. Touch the [OK] key to return to the base screen of the copy mode.

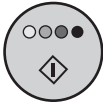

or



Press the [COLOR START] key (○●●●) or the [BLACK & WHITE START] key (○●).

Copying will begin.

- If the originals were placed in the document feeder tray, the originals are copied.
- If you are using the document glass, copy each page one page at a time.

If you are using the sort function or other function that requires all originals to be scanned before the copies are printed, you must use the same [START] key that you used to scan the first original to scan each of the remaining originals.



**To cancel scanning of the original and copying...**

Press the [STOP] key (⏏).



**To cancel the mirror image setting...**

Touch the [Mirror Image] key in the screen of step 4 so that it is not highlighted.

# COPYING AN 11" x 17" SIZE ORIGINAL WITHOUT CUTTING OFF THE EDGES (11x17 Full Bleed)

This feature lets you copy an entire 11" x 17" (A3) size original at full size with no image cut-off at the edges. 12" x 18" (A3W) size is used, which is slightly larger than 11" x 17" (A3) size.

11" x 17" (A3) size original

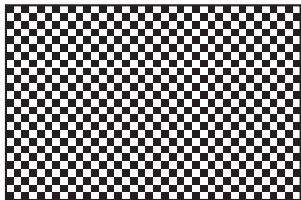

12" x 18" (A3) full bleed copy

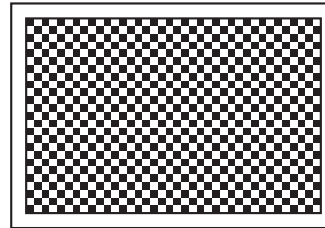

1

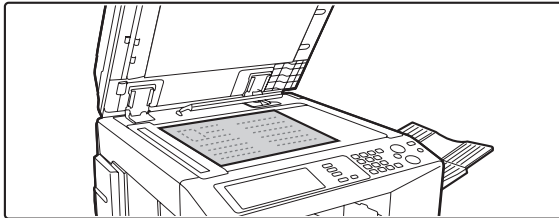

Place the original face down on the document glass.

2

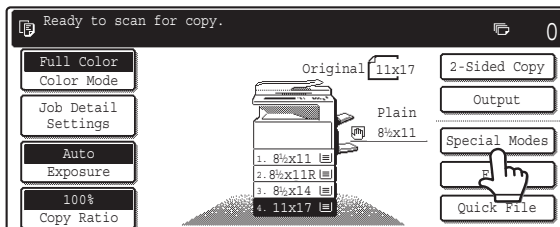

Touch the [Special Modes] key.

3

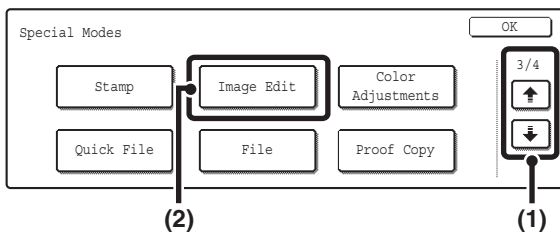

Select Image Edit.

(1) Touch the keys to switch through the screens.

(2) Touch the [Image Edit] key.

4

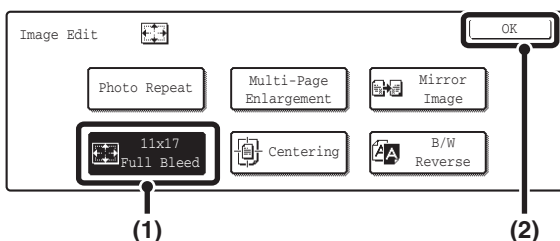

Select 11x17 Full Bleed.

(1) Touch the [11x17 Full Bleed] key so that it is highlighted.

(2) Touch the [OK] key.

When the [OK] key is touched, you will return to the special mode screen. Touch the [OK] key to return to the base screen of the copy mode.

5

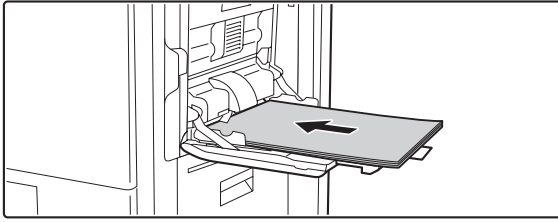

## Place 12" x 18" (A3W) paper in the bypass tray.

Pull out the extension tray, adjust the guides to the width of 12" x 18" (A3W) paper, and place the paper in the bypass tray.

6

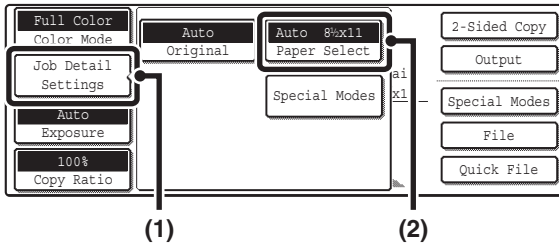

## Select the paper.

- (1) Touch the [Job Detail Settings] key.
- (2) Touch the [Paper Select] key.

7

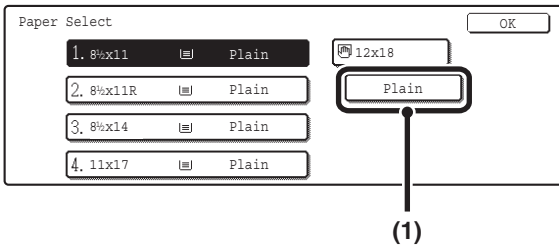

## Select settings for 12" x 18" (A3W) paper.

- (1) Touch the appropriate paper type key.

Touch the key that shows the type of 12" x 18" (A3W) paper you loaded.

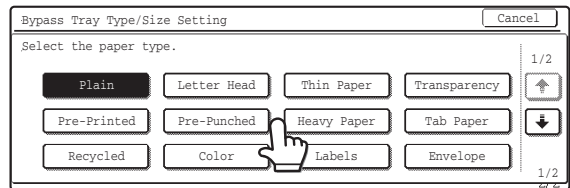

- (2) Touch the [Auto-Inch] key and then the [OK] key.

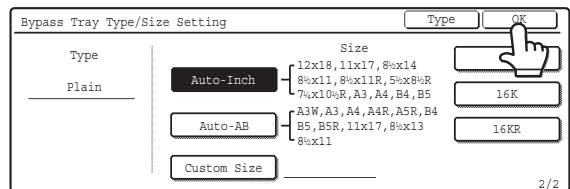

8

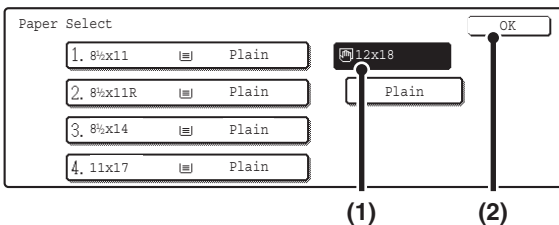

## Select the bypass tray.

- (1) Touch the paper size key of the bypass tray.
- (2) Touch the [OK] key.

When the [OK] key is touched, you will return to the job detail setting screen. Touch the [Job Detail Setting] key to return to the base screen of copy mode.

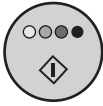

or



Press the [COLOR START] key (○●●●) or the [BLACK & WHITE START] key (○●).

Copying of the original on the document glass begins.

If you are using the sort function or other function that requires all originals to be scanned before the copies are printed, you must use the same [START] key that you used to scan the first original to scan each of the remaining originals.



**To cancel scanning of the original and copying...**

Press the [STOP] key (⊘).



- This function can be used when a right tray, a finisher, or a saddle stitch finisher is installed.
- The copy ratio is 100% when this function is used. The ratio cannot be changed.
- Automatic 2-sided copying is not possible.
- The punch function cannot be used.
- The original must be placed on the document glass.





**To cancel 11x17 Full Bleed...**

Touch the [11x17 Full Bleed] key in the screen of step 4 so that it is not highlighted.

# COPYING IN THE CENTER OF THE PAPER (Centering)

This is used to center the copied image on the paper.

This lets you place the image in the center of the paper when the original size is smaller than the paper size or when the image is reduced.

Not using the centering function	Using the centering function
	

1

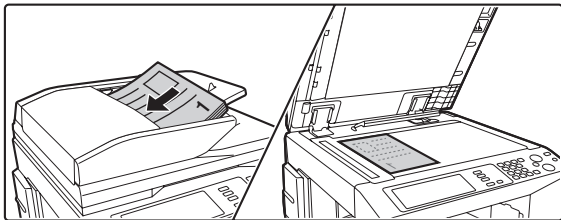

## Place the original.

Place the original face up in the document feeder tray, or face down on the document glass.

2

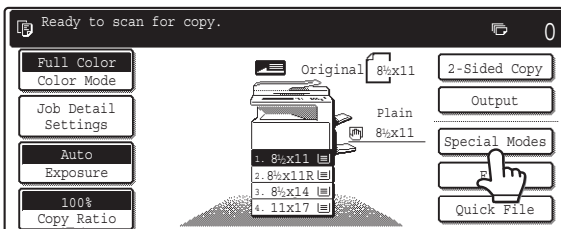

## Touch the [Special Modes] key.

3

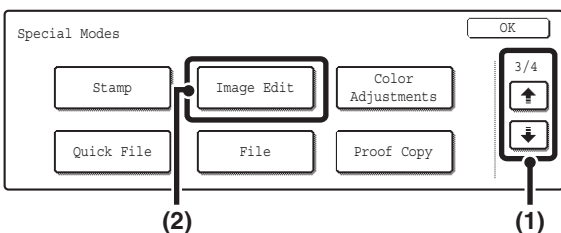

## Select Image Edit.

- (1) Touch the   keys to switch through the screens.
- (2) Touch the [Image Edit] key.

4

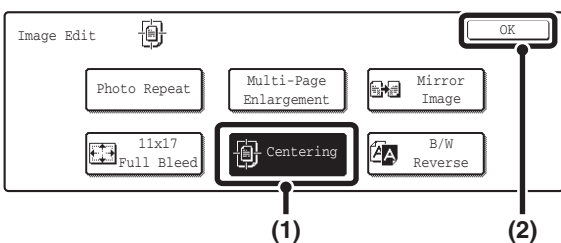

## Select Centering.

- (1) Touch the [Centering] key so that it is highlighted.
- (2) Touch the [OK] key.

When the [OK] key is touched, you will return to the special mode screen. Touch the [OK] key to return to the base screen of the copy mode.

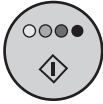

or



Press the [COLOR START] key (○●●●) or the [BLACK & WHITE START] key (○●).

Copying will begin.

- If the originals were placed in the document feeder tray, the originals are copied.
- If you are using the document glass, copy each page one page at a time.

If you are using the sort function or other function that requires all originals to be scanned before the copies are printed, you must use the same [START] key that you used to scan the first original to scan each of the remaining originals.



**To cancel scanning of the original and copying...**

Press the [STOP] key (⏹).



- The image can be reduced when using the Centering function, but not enlarged.
- When the original size or the paper size is displayed as a special size, this function cannot be used.



**To cancel centering...**

Touch the [Centering] key in the screen of step 4 so that it is not highlighted.



# REVERSING WHITE AND BLACK IN A COPY (B/W Reverse)

This is used to reverse black and white in a copy to create a negative image. This function can only be used for black and white copying.

Originals with large black areas (which use a large amount of toner) can be copied using Black/White Reverse to reduce toner consumption.

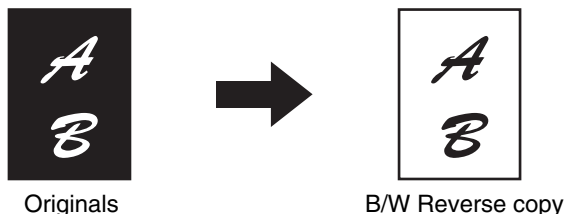

1

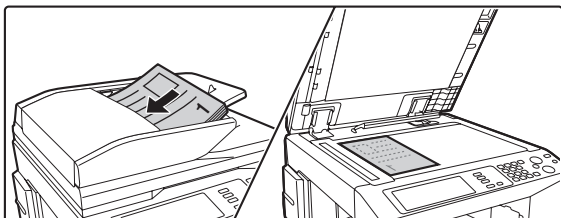

## Place the original.

Place the original face up in the document feeder tray, or face down on the document glass.

2

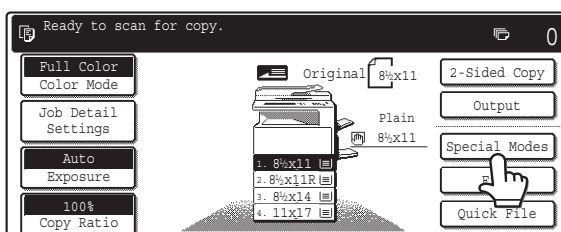

## Touch the [Special Modes] key.

3

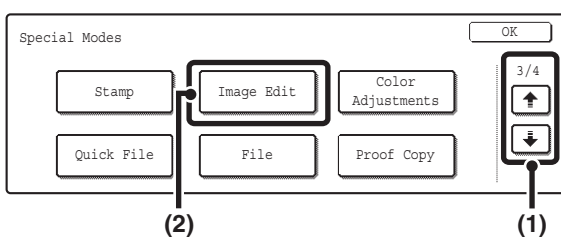

## Select Image Edit.

- (1) Touch the keys to switch through the screens.
- (2) Touch the [Image Edit] key.

4

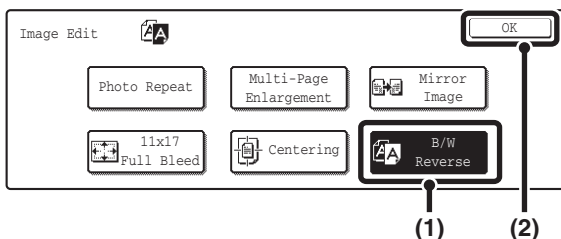

## Select B/W Reverse.

- (1) Touch the [B/W Reverse] key so that it is highlighted.
- (2) Touch the [OK] key.

When the [OK] key is touched, you will return to the special mode screen. Touch the [OK] key to return to the base screen of the copy mode.



## Press the [BLACK & WHITE START] key (○●).

Copying will begin.

- If the originals were placed in the document feeder tray, the originals are copied.
- If you are using the document glass, copy each page one page at a time.



When using this function, the [COLOR START] key (○●●●) cannot be used.



### To cancel scanning of the original and copying...

Press the [STOP] key (⊘).



When this function is selected, the exposure mode setting automatically changes to "Text".



### To cancel B/W reverse...

Touch the [B/W Reverse] key in the screen of step 4 so that it is not highlighted.

# ADJUSTING RED/GREEN/BLUE IN COPIES (RGB Adjust)

This feature is used to strengthen or weaken any one of the three color components R (red), G (green), or B (blue). For an image adjustment example, see "Adjusting red/green/blue in copies (RGB Adjust)" in the Quick Start Guide.

1

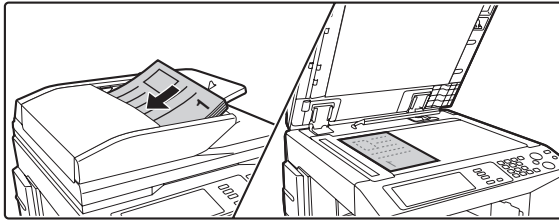

## Place the original.

Place the original face up in the document feeder tray, or face down on the document glass.

2

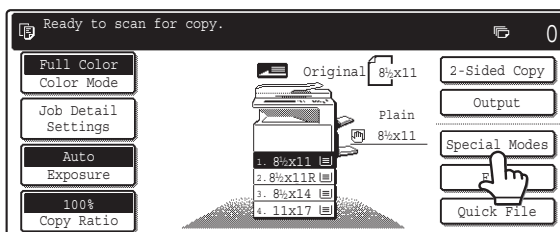

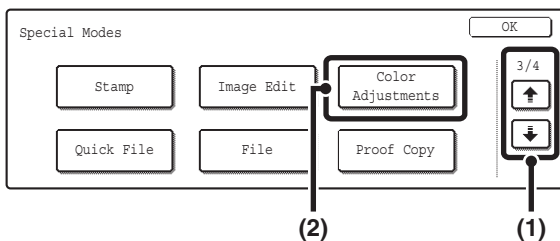

## Touch the [Special Modes] key.

3



## Select Color Adjustments.

- (1) Touch the   keys to switch through the screens.
- (2) Touch the [Color Adjustments] key.

4

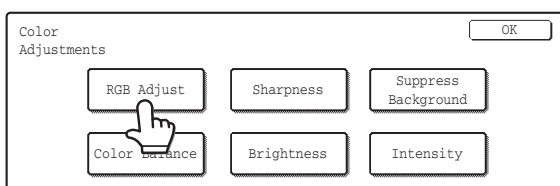

## Touch the [RGB Adjust] key.

5

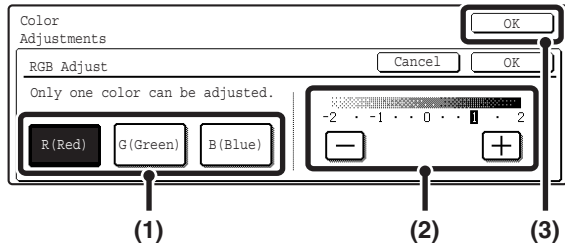

## Adjust red, green, or blue.

(1) Touch the key of the color that you wish to adjust: [R (Red)], [G (Green)], or [B (Blue)].

Only one color can be adjusted. (If you adjust one color and then adjust another color, the adjustment of the first color is canceled.)

(2) Adjust the selected color.

Touch the [+] key to strengthen the selected color, or touch the [-] key to weaken the color.

(3) Touch the [OK] key.

When the [OK] key is touched, you will return to the special mode screen. Touch the [OK] key to return to the base screen of the copy mode.

6

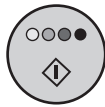

## Press the [COLOR START] key (○●●◇).

Copying will begin.

- If the originals were placed in the document feeder tray, the originals are copied.
- If you are using the document glass, copy each page one page at a time.



### To cancel scanning of the original and copying...

Press the [STOP] key (⊞).



### To cancel the RGB adjust setting...

Touch the [Cancel] key in the screen of step 5.

# ADJUSTING THE SHARPNESS OF AN IMAGE (Sharpness)

This is used to sharpen an image or make it softer.

For an image adjustment example, see "Adjusting the sharpness of an image (Sharpness)" in the Quick Start Guide.

1

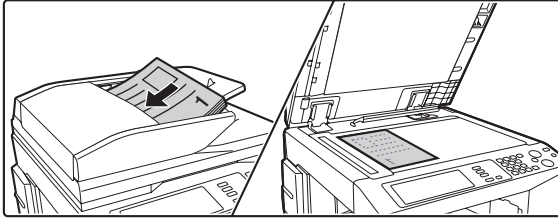

## Place the original.

Place the original face up in the document feeder tray, or face down on the document glass.

2

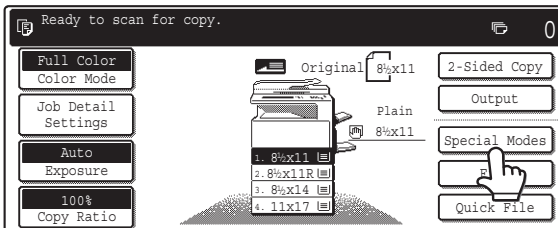

## Touch the [Special Modes] key.

3

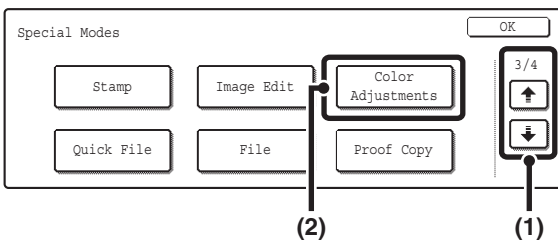

## Select Color Adjustments.

(1) Touch the   keys to switch through the screens.

(2) Touch the [Color Adjustments] key.

4

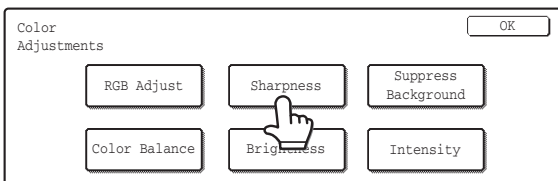

## Touch the [Sharpness] key.

5

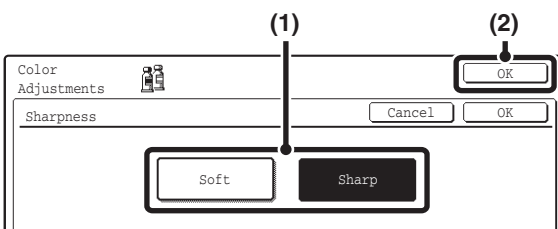

## Adjust the image.

(1) Touch the [Soft] key or the [Sharp] key.

(2) Touch the [OK] key.

When the [OK] key is touched, you will return to the special mode screen. Touch the [OK] key to return to the base screen of the copy mode.

6

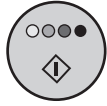

**Press the [COLOR START] key (○●●●).**

Copying will begin.

- If the originals were placed in the document feeder tray, the originals are copied.
- If you are using the document glass, copy each page one page at a time.



**To cancel scanning of the original and copying...**

Press the [STOP] key (⏹).



**To cancel the sharpness setting...**

Touch the [Cancel] key in the screen of step 5.

# WHITENING FAINT COLORS IN COPIES (Suppress Background)

This feature is used to suppress light background areas.

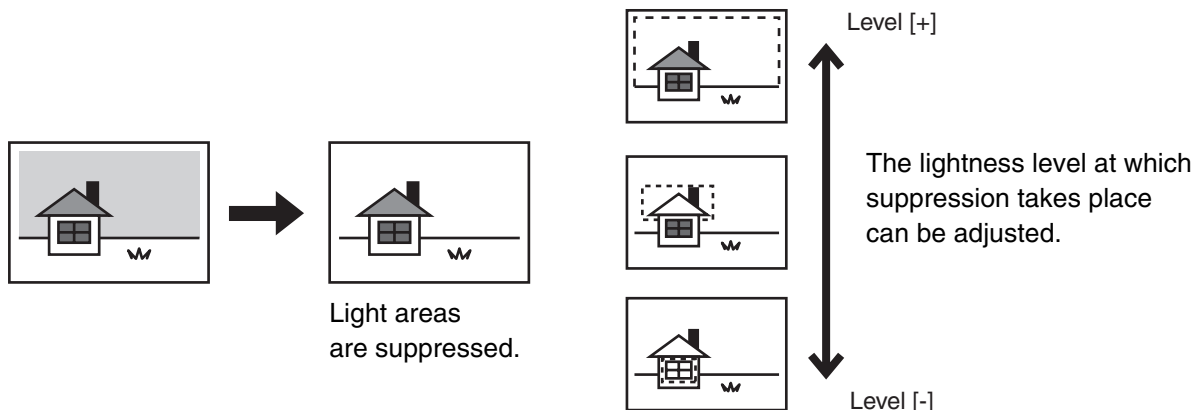

1

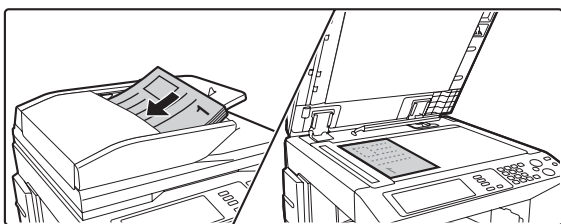

## Place the original.

Place the original face up in the document feeder tray, or face down on the document glass.

2

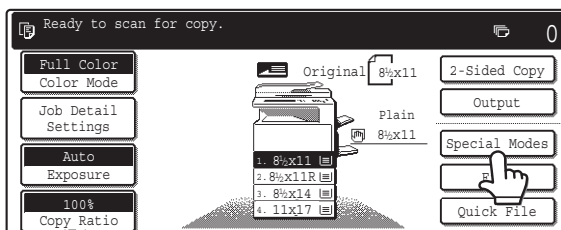

## Touch the [Special Modes] key.

3

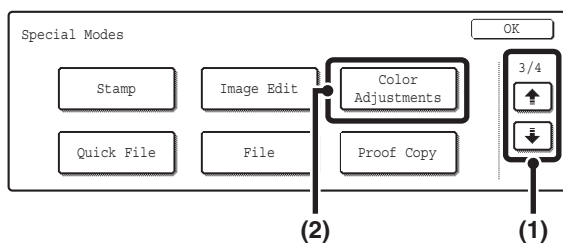

## Select Color Adjustments.

- (1) Touch the keys to switch through the screens.
- (2) Touch the [Color Adjustments] key.

4

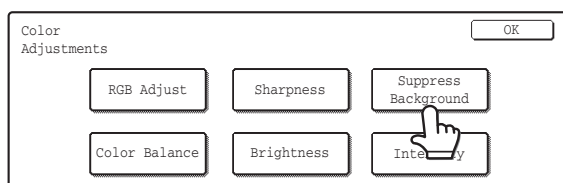

## Touch the [Suppress Background] key.

5

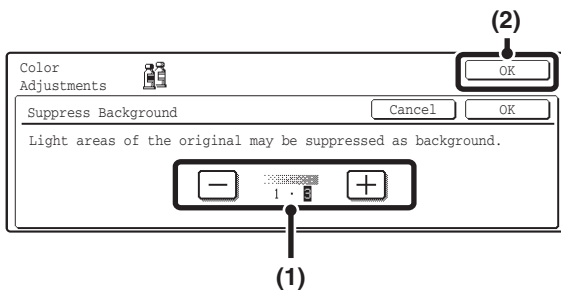

## Select suppress background settings.

### (1) Adjust the background suppression level.

To strengthen the background suppression level (suppress darker backgrounds), touch the [-] key. To weaken the level (suppress only light backgrounds), touch the [+] key.

### (2) Touch the [OK] key.

When the [OK] key is touched, you will return to the special mode screen. Touch the [OK] key to return to the base screen of the copy mode.

6

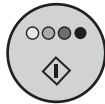

## Press the [COLOR START] key (○●●●).

Copying will begin.

- If the originals were placed in the document feeder tray, the originals are copied.
- If you are using the document glass, copy each page one page at a time.



### To cancel scanning of the original and copying...

Press the [STOP] key (⊘).



### To cancel the Suppress background setting...

Touch the [Cancel] key in the screen of step 5.



# ADJUSTING THE COLOR (Color Balance)

The color, tone, and density of color copies can be adjusted.

For an image adjustment example, see "Adjusting the color (Color Balance)" in the Quick Start Guide.

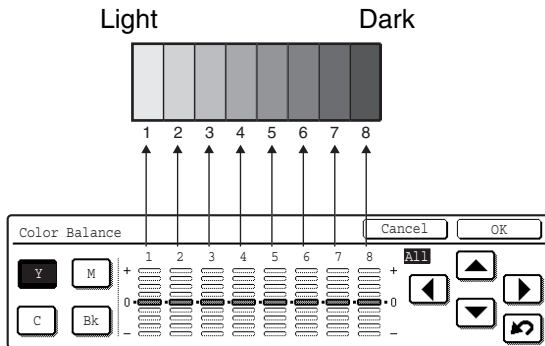

Each of the colors yellow, cyan, magenta, and black are divided into 8 gradations from light to dark, and the average density of each gradation can be adjusted. Each of the 8 gradations can be adjusted separately, or all eight gradations can be adjusted at once.

1

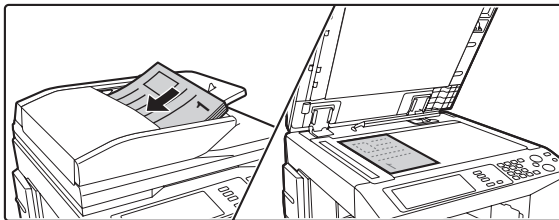

## Place the original.

Place the original face up in the document feeder tray, or face down on the document glass.

2

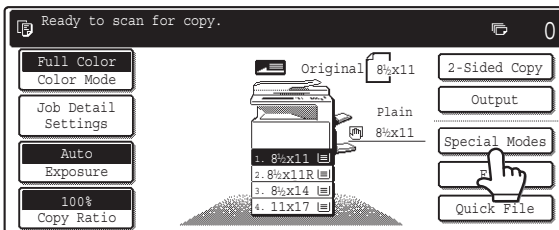

## Touch the [Special Modes] key.

3

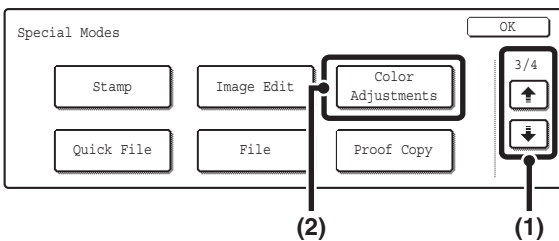

## Select Color Adjustments.

(1) Touch the  $\downarrow$   $\uparrow$  keys to switch through the screens.

(2) Touch the [Color Adjustments] key.

4

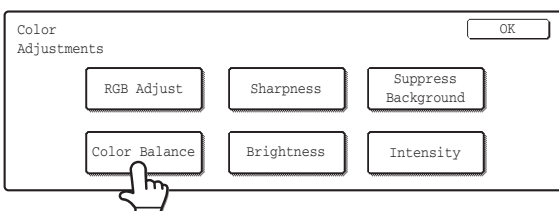

## Touch the [Color Balance] key.

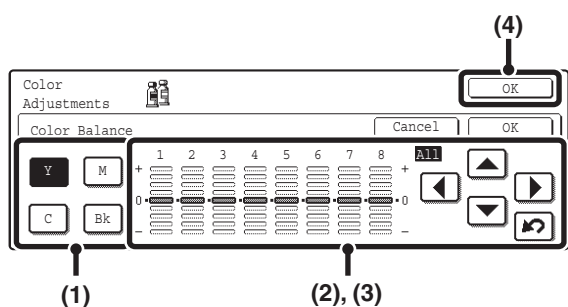

## Adjust the color balance.

### Examples of color balance adjustment

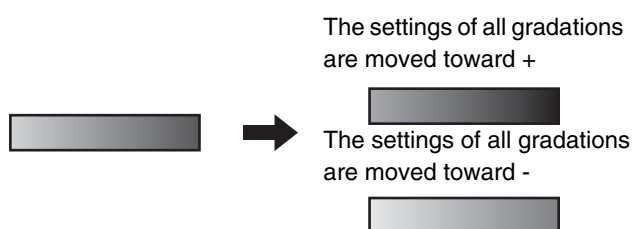

#### (1) Select the color to be adjusted.

Select [Y] (yellow), [M] (magenta), [C] (cyan), or [Bk] (black).

If only the rectangular area around the letter in a key is highlighted, the settings have been changed from the factory default settings.

#### (2) Select the gradation to be adjusted.

Select the gradation with the keys.

Touch the keys to move the highlighting to one of gradations "1" to "8" or "ALL".

To adjust all eight gradations at once, move the highlighting to "ALL".

#### (3) Adjust the density.

To darken the density of the selected gradation, touch the key. To lighten the density, touch the key. Each time one of the keys is touched, the indicator frame moves up or down one level.

#### (4) Touch the [OK] key.

When the [OK] key is touched, you will return to the special mode screen. Touch the [OK] key to return to the base screen of the copy mode.



#### To return the color balance values to the default settings...

Touch the key. The values of all 8 gradations return to the default color balance values.

The default color balance values are set in "Initial Color Balance Setting" in the system settings (administrator).

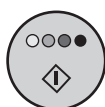

## Press the [COLOR START] key (○●●●).

Copying will begin.

- If the originals were placed in the document feeder tray, the originals are copied.
- If you are using the document glass, copy each page one page at a time.



#### To cancel scanning of the original and copying...

Press the [STOP] key ().



#### To cancel the color balance setting...

Touch the [Cancel] key in the screen of step 5.



#### System Settings (Administrator): Initial Color Balance Setting

This is used to set the default values to which the color balance values return when the key is pressed.

# ADJUSTING THE BRIGHTNESS OF A COPY (Brightness)

The brightness of color images can be adjusted.

For an image adjustment example, see "Adjusting the brightness of a copy (Brightness)" in the Quick Start Guide.

1

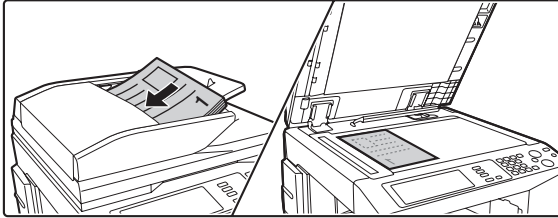

## Place the original.

Place the original face up in the document feeder tray, or face down on the document glass.

2

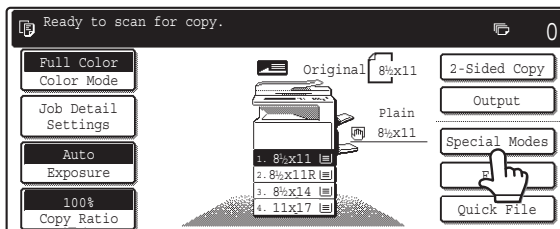

## Touch the [Special Modes] key.

3

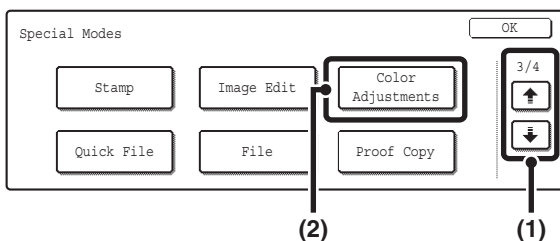

## Select Color Adjustments.

(1) Touch the   keys to switch through the screens.

(2) Touch the [Color Adjustments] key.

4

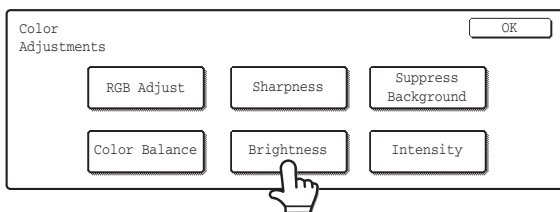

## Touch the [Brightness] key.

5

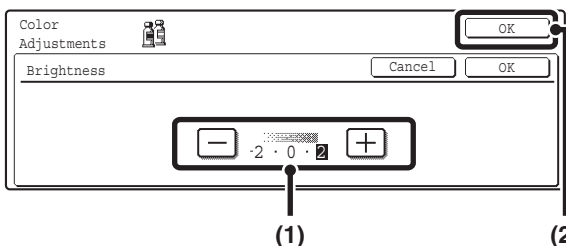

## Adjust the brightness.

(1) Adjust the brightness.

Touch the [+] key to make the image brighter, or the [-] key to make the image darker.

(2) Touch the [OK] key.

When the [OK] key is touched, you will return to the special mode screen. Touch the [OK] key to return to the base screen of the copy mode.

6

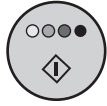

**Press the [COLOR START] key (○●●●).**

Copying will begin.

- If the originals were placed in the document feeder tray, the originals are copied.
- If you are using the document glass, copy each page one page at a time.



**To cancel scanning of the original and copying...**

Press the [STOP] key (⏏).



**To cancel the brightness setting...**

Touch the [Cancel] key in the screen of step 5.

# ADJUSTING THE INTENSITY OF A COPY (Intensity)

This is used to adjust the intensity (saturation) of color images.

For an image adjustment example, see "Adjusting the intensity of a copy (Intensity)" in the Quick Start Guide.

1

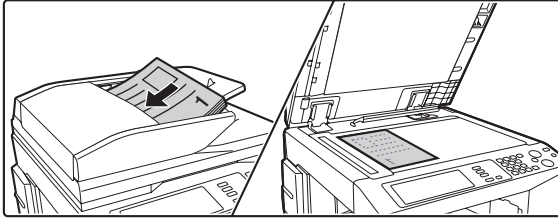

## Place the original.

Place the original face up in the document feeder tray, or face down on the document glass.

2

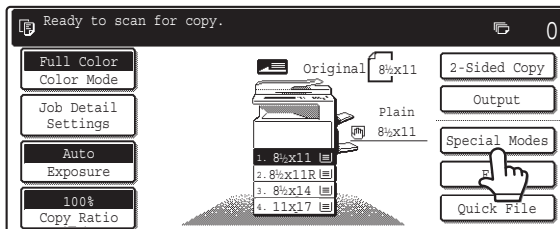

## Touch the [Special Modes] key.

3

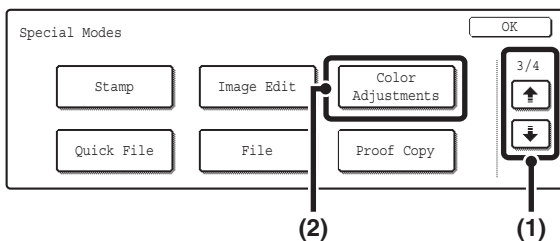

## Select Color Adjustments.

(1) Touch the  $\downarrow$   $\uparrow$  keys to switch through the screens.

(2) Touch the [Color Adjustments] key.

4

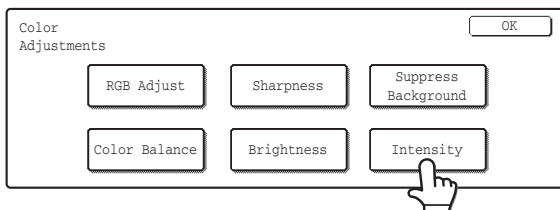

## Touch the [Intensity] key.

5

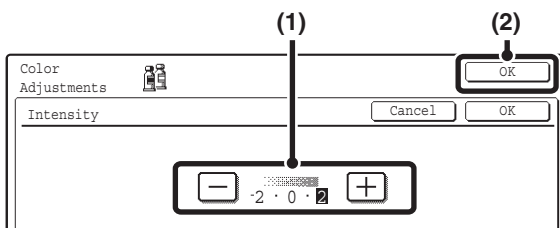

## Adjust the intensity.

(1) Adjust the intensity.

Touch the [+] key to strengthen the intensity, or the [-] key to weaken the intensity.

(2) Touch the [OK] key.

You will return to the base screen of copy mode.

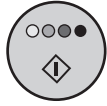

**Press the [COLOR START] key (○●●●).**

Copying will begin.

- If the originals were placed in the document feeder tray, the originals are copied.
- If you are using the document glass, copy each page one page at a time.



**To cancel scanning of the original and copying...**

Press the [STOP] key (◻).



This function cannot be used in combination with "Color Tone Enhancement" in the copy exposure settings.



**To cancel the intensity setting...**

Touch the [Cancel] key in the screen of step 5.

# CHECKING COPIES BEFORE PRINTING (Proof Copy)

This feature prints only one set of copies, regardless of how many sets have been specified. After the first set is checked for errors, the remaining sets can be printed. Normally it is necessary to re-scan the original each time changes to settings are required. However, this feature makes it possible to change settings for the scanned original without scanning it again, allowing you perform copying more efficiently.

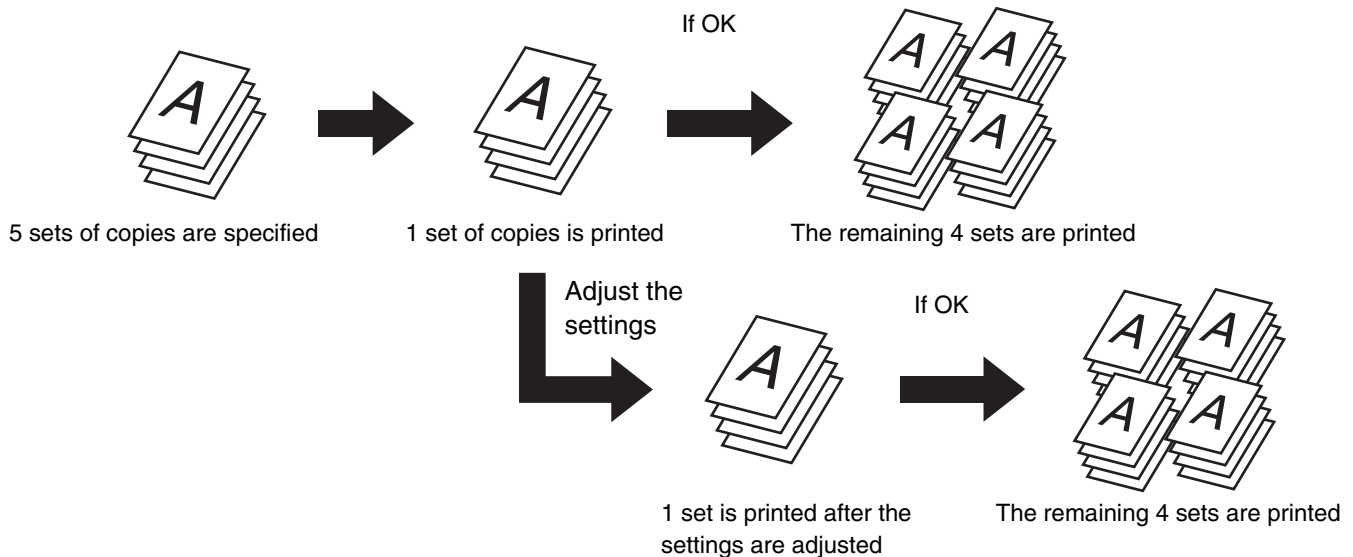

1

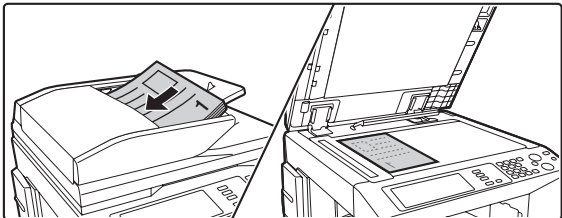

**Place the original.**

Place the original face up in the document feeder tray, or face down on the document glass.

2

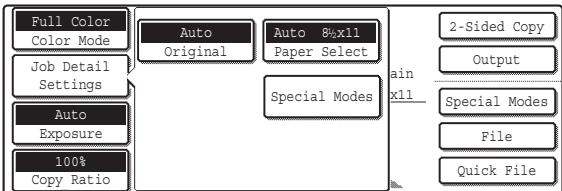

**Select copy settings.**

3

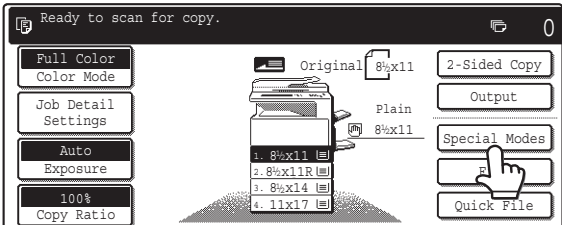

**Touch the [Special Modes] key.**

4

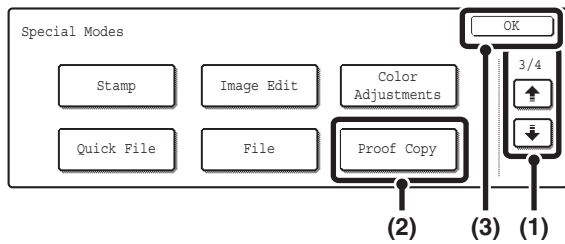

### Select Proof Copy.

- (1) Touch the keys to switch through the screens.
- (2) Touch the [Proof Copy] key.
- (3) Touch the [OK] key.

5

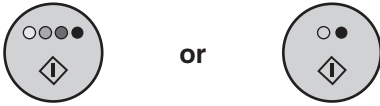

Press the [COLOR START] key (○●●●) or the [BLACK & WHITE START] key (○●).



#### To cancel copying...

Press the [STOP] key (⊘).

6

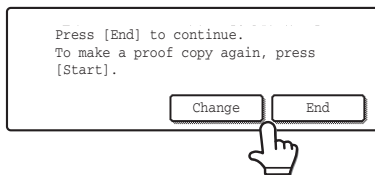

If there are no problems with the first set that is printed, touch the [End] key. If you need to make changes, touch the [Change] key.

If the [End] key is touched, the remaining sets are printed. If you touched the [Change] key, go to the next step.



#### To cancel copying...

Press the [STOP] key (⊘).

7

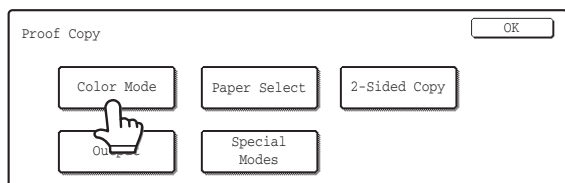

### Select the settings that you wish to change.

After changing a setting, touch the [OK] key in that screen. You will return to this screen.



- Special modes that can be adjusted are "Margin Shift", "Pamphlet Copy", "Tandem Copy", "Covers/Inserts", "Transparency Inserts", "Multi Shot", and "Stamp".
- For "Pamphlet Copy", "Covers/Inserts", and "Multi Shot", only changes to the settings of those functions can be made; neither of these functions can be newly added or deleted.

8

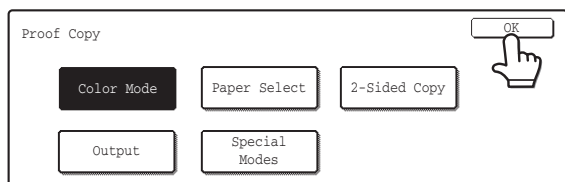

Touch the [OK] key.



9

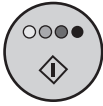

or



**Press the [COLOR START] key (○●●●) or the [BLACK & WHITE START] key (○●).**

One set of copies is printed again using the adjusted settings. The number of sets does not change at this time.

If settings must be adjusted again, repeat steps 6 through 9 until there are no problems.

When you are ready to print the remaining sets, go to the next step.

10

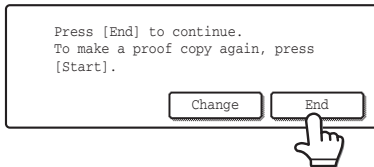

**Touch the [End] key.**

You will return to the base screen of copy mode and the remaining sets will be printed.



**To cancel scanning of the original and copying...**

Press the [STOP] key (⏹).



If proof copy is performed when the machine is already printing a copy job or other job, the job in progress will stop temporarily and the set of proof copies will be printed. The previous job will resume after the proof copies are printed. When the [End] key is touched, printing of the remaining sets will start after the copy job in progress is completed.

# COPYING ORIGINALS OF DIFFERENT SIZES (Mixed Size Original)

Originals of mixed sizes can be copied together, such as 11" x 17" (A3) originals mixed in with 8-1/2" x 14" (B4) originals. When scanning the originals, the machine automatically detects the size of each original and uses paper appropriate for that size.

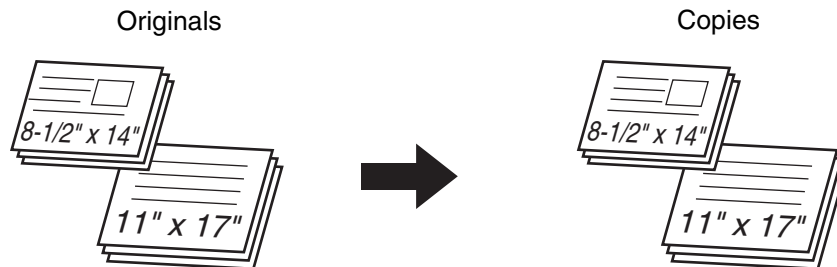

There are two settings for mixed size originals.

<p><b>Same Width</b></p>	<p>Use this setting for originals that are different sizes but have sides that are the same length. The originals are inserted in the document feeder tray with the sides that are the same length aligned together on the left. 11" x 17" and 8-1/2" x 11", 8-1/2" x 14" and 8-1/2" x 11"R, 8-1/2" x 14" and 5-1/2" x 8-1/2", 8-1/2" x 13" and 8-1/2" x 11"R, 8-1/2" x 13" and 5-1/2" x 8-1/2", 8-1/2" x 11"R and 5-1/2" x 8-1/2" (A3 and A4, B4 and B5, A4R and A5)</p>
<p><b>Different Width</b></p>	<p>Use this setting when the originals are different sizes and do not have sides that are the same length. This setting can only be used for the following combinations of sizes: 11" x 17" and 8-1/2" x 14", 11" x 17" and 8-1/2" x 13", 11" x 17" and 5-1/2" x 8-1/2" (A3 and B4, B4 and A4R, A4 and B5, B5 and A5)</p>

## Insert the originals face up in the document feeder tray.

### ● When "Same Width" is used

Place the originals with the sides that are the same length aligned on the left.

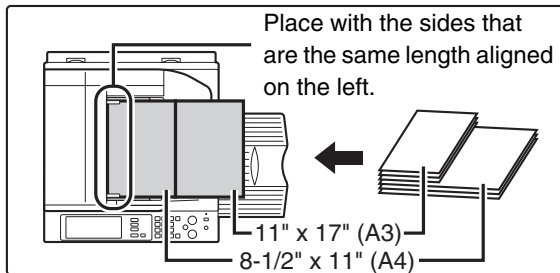

### ● When "Different Width" is used

Place the originals with the corners aligned in the far left corner of the document feeder tray.

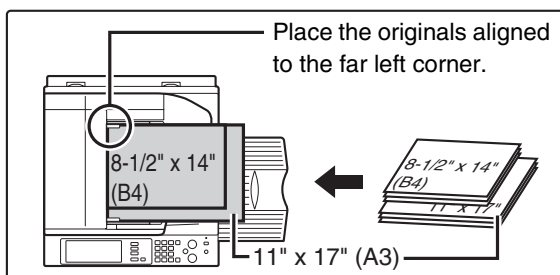

## Touch the [Special Modes] key.

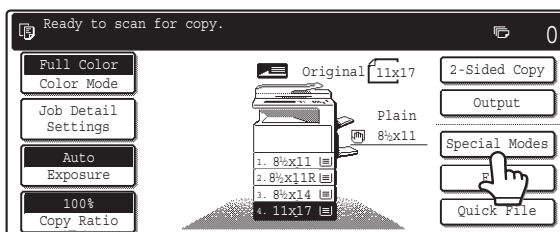

## Select Mixed Size Original.

(1) Touch the keys to switch through the screens.

(2) Touch the [Mixed Size Original] key.

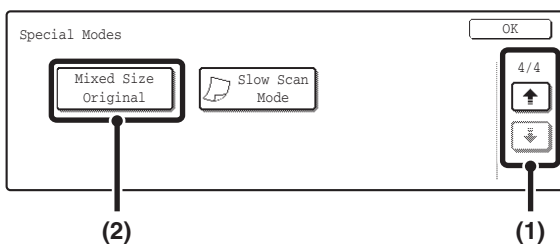

4

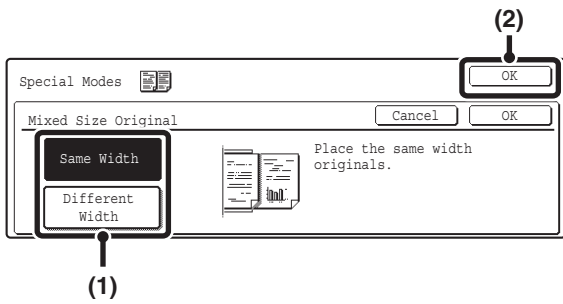

### Select Mixed Size Original settings.

(1) Touch the [Same Width] key or the [Different Width] key as appropriate for the originals.

(2) Touch the [OK] key.

You will return to the base screen of copy mode.

5

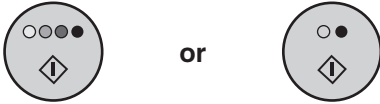

Press the [COLOR START] key (○●●●) or the [BLACK & WHITE START] key (○●).

Copying of the originals in the document feeder tray begins.



**To cancel scanning of the original and copying...**

Press the [STOP] key (⏹).



- When "Different Width" is used, 2-sided copying cannot be used.
- When "Different Width" is used, the staple function cannot be used.
- "Different Width" cannot be used to place the same size of originals in different orientations.



**To cancel the mixed size original setting...**

Touch the [Cancel] key in the screen of step 4.

# COPYING THIN ORIGINALS (Slow Scan Mode)

Use this function when you wish to scan thin originals using the automatic document feeder. This function helps prevent thin originals from misfeeding.

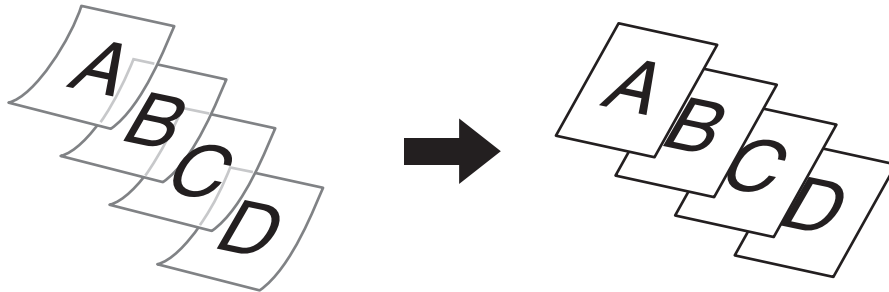

1

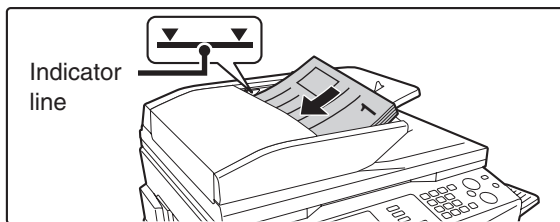

**Place the originals face up in the document feeder tray with the edges aligned evenly.**

Place the originals face up. Insert the originals all the way into the document feeder tray. The stack must not be higher than the indicator line (no more than 100 sheets).



If the originals are inserted with too much force, they may crumple and misfeed.

2

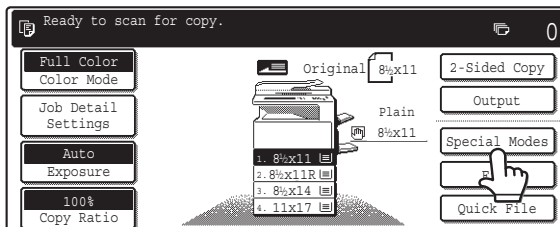

**Touch the [Special Modes] key.**

3

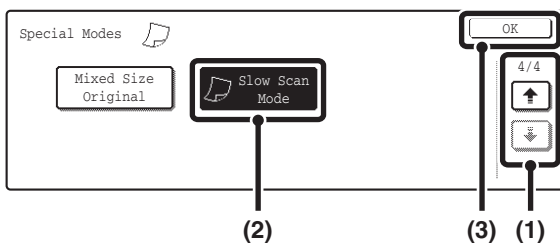

**Select Slow Scan Mode.**

- (1) Touch the keys to switch through the screens.
- (2) Touch the [Slow Scan Mode] key so that it is highlighted.
- (3) Touch the [OK] key.

You will return to the base screen of copy mode.

4

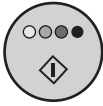

or



Press the [COLOR START] key (○●●●) or the [BLACK & WHITE START] key (○●).

Copying of the originals in the document feeder tray begins.



**To cancel scanning of the original and copying...**

Press the [STOP] key (⏹).



The "2-Side to 2-Side" and "2-Side to 1-Side" modes of automatic two-sided copying cannot be used.



**To cancel the slow scan mode setting...**

Touch the [Slow Scan Mode] key in the screen of step 3 so that it is not highlighted.

# STORING COPY OPERATIONS (Job Programs)

A job program is a group of copy settings stored together. When copy settings are stored in a job program, the settings can be called up and used for a copy job by means of a simple operation.

For example, suppose 11" x 17" (A3) size CAD drawings are copied once a month for archive purposes using the following settings:

- (1) The 11" x 17" (A3) size CAD drawings are reduced to 8-1/2" x 11"(A4) size.
- (2) The drawings have fine lines that do not show clearly, and thus a dark exposure setting (level 4) is used.
- (3) To reduce paper use by a half, 2-sided copying is used.
- (4) Margin shift is used so that holes can be punched for filing.

11" x 17" (A3) size CAD drawings

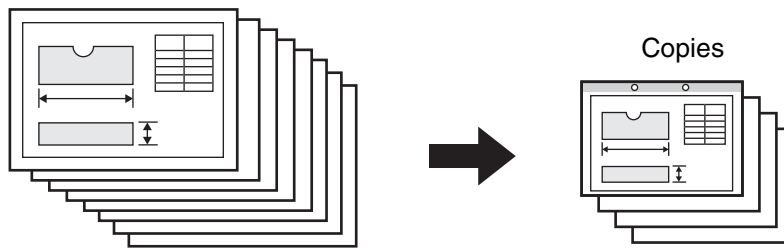

When a job program is not stored	When a job program is stored
<p>Set 11" x 17" (A3) to 8-1/2" x 11" (A4) reduction</p> <p style="text-align: center;">↓</p> <p>Change the exposure setting</p> <p style="text-align: center;">↓</p> <p>Select 2-sided copying</p> <p style="text-align: center;">↓</p> <p>Select margin shift</p> <p style="text-align: center;">↓</p> <p>Select punch hole settings</p> <p style="text-align: center;">↓</p> <div style="text-align: center;"> </div> <p>Press the [COLOR START] key or the [BLACK &amp; WHITE START] key.</p>	<p style="text-align: center;">#/P</p> <p style="text-align: center;">Press the [Program] key ( #/P ).</p> <p style="text-align: center;">↓</p> <div style="text-align: center;"> </div> <p style="text-align: center;">Touch the stored program key.</p> <p style="text-align: center;">↓</p> <div style="text-align: center;"> </div> <p>Press the [COLOR START] key or the [BLACK &amp; WHITE START] key.</p>
<p>Considerable time is required to copy the drawings each month because the above settings must be selected. In addition, mistakes are occasionally made when selecting the settings, so some copies must be redone.</p>	<p>The settings are stored in a job program, so they can be selected by the touch of a key. This is simple and takes no time. In addition, the settings are all stored so there are no chances for mistakes, and thus no need to redo copies due to setting mistakes.</p>

- Up to 48 job programs can be stored. The job programs are retained even if an interruption occurs in the power supply.
- Job programs can also be stored in the Web pages. Click [Job Program Registration] and then [Copy] in the Web page menu to store a job program.

# STORING A JOB PROGRAM

The procedure for storing copy settings in a job program is explained below.

1

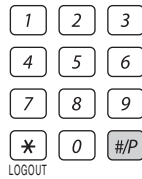

Press the [PROGRAM] key ( **#/P** ).

2

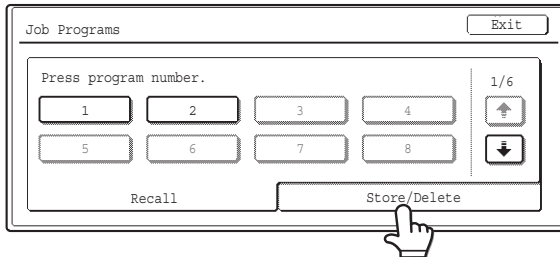

Touch the [Store/Delete] tab.

3

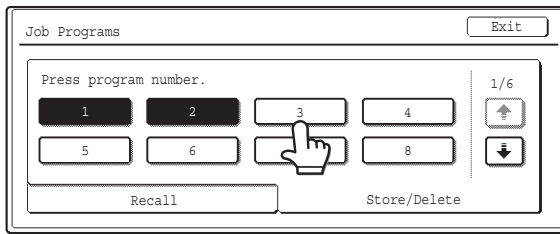

Touch a numeric key that is not highlighted.

Numeric keys in which job programs are already stored are highlighted.



If a highlighted numeric key is touched, the following screen appears. The [Store] key can be touched to delete the stored settings and store new settings.



When "Disabling Deletion of Job Programs" is enabled in the system settings (administrator), this function cannot be used.

4

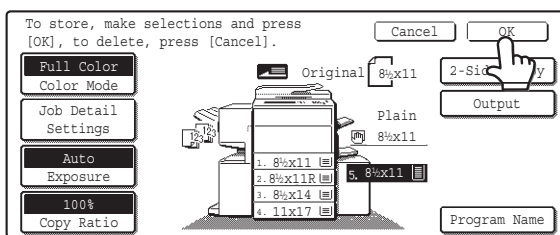

Select the copy settings that you wish to store in the job program and touch the [OK] key.

To assign a name to the program, touch the [Program Name] key. A text entry screen will appear.

Up to 10 characters can be entered for the name.

To enter text, see "6. ENTERING TEXT" in the User's Guide.

When you have finished entering the name, touch the [OK] key.



The number of copies cannot be stored.



5

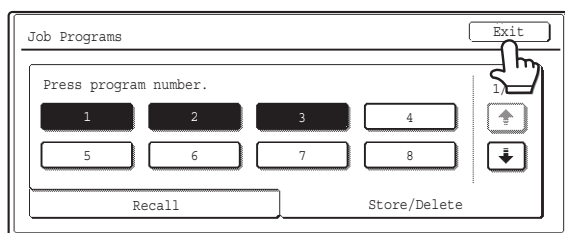

Touch the [Exit] key.

## DELETING A JOB PROGRAM

The procedure for deleting a job program is explained below.

1



Press the [PROGRAM] key (**#P**).

2

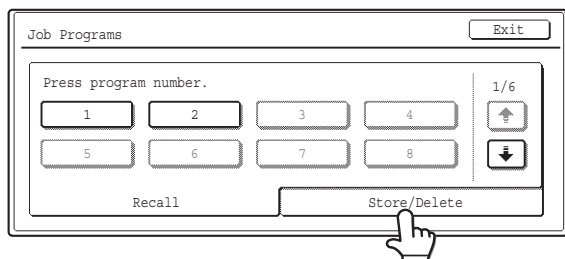

Touch the [Store/Delete] tab.

3

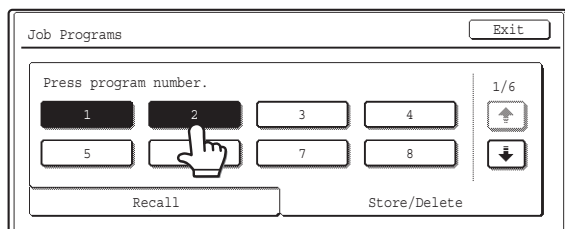

Touch the numeric key in which the job program that you wish to delete is stored.

4

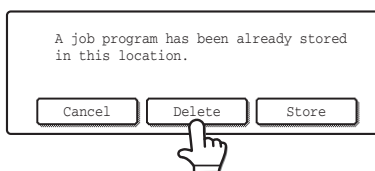

Touch the [Delete] key.

5

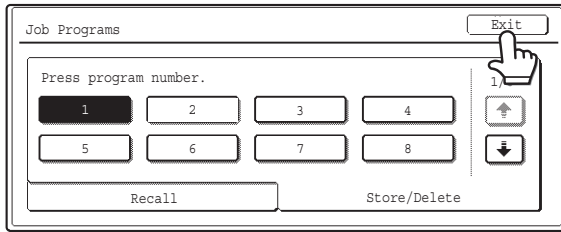

Touch the [Exit] key.



When "Disabling Deletion of Job Programs" is enabled in the system settings (administrator), this function cannot be used.

# APPENDIX

## Examples of covers and inserts

The relations between the originals and finished copies when covers or inserts are inserted are shown on the following pages.

### Covers

- 1-sided copying of 1-sided originals
- 1-sided copying of 2-sided originals
- 2-sided copying of 1-sided originals
- 2-sided copying of 2-sided originals

### Inserts

- 1-sided copying of 1-sided originals
- 1-sided copying of 2-sided originals
- 2-sided copying of 1-sided originals
- 2-sided copying of 2-sided originals

## Symbols used for covers and inserts

The following symbols are used to make the explanations easier to understand.



















The numbers that appear indicate what original a copy corresponds to, and will vary depending on the settings.

Type	Symbol	Meaning	Icon appearing in display	Type	Symbol	Meaning	Icon appearing in display
Front cover		Front cover when not copied on.		Inserts		Insert when not copied on.	
		Front cover when 1 side is copied on.				Insert when 1 side is copied on.	
		Front cover when a 2-sided original is copied on 1 side of the cover. (One page is not copied.)				Insert when a 2-sided original is copied on 1 side of the insert. (1 page is not copied.)	
		Front cover when both sides are copied on.				Insert when both sides are copied on.	
Back cover		Back cover when not copied on.		Other symbols		1-sided original or output page of regular 1-sided copying.	
		Back cover when a 1-sided original is copied on 1 side of the back cover.				2-sided original or output page of regular 2-sided copying.	
		Back cover when a 2-sided original is copied on 1 side of the back cover. (One page is not copied.)				1-sided original or output page of regular 1-sided copying.	
		Back cover when both sides are copied on.				Output page of 2-sided copying when only 1 side is copied on due to lack of originals.	

# Covers (1-sided copying of 1-sided originals)

1-sided copies are made of the following 1-sided originals.



1st page	2nd page	3rd page	4th page	5th page	6th page
1	2	3	4	5	6

Cover copying condition		Resulting copies							
Front cover	Back cover								
No copying	No copying		1	2	3	4	5	6	
1-sided copying	No copying		2	3	4	5	6		
2-sided copying	No copying		3	4	5	6			
No copying	1-sided copying		1	2	3	4	5		
No copying	2-sided copying		1	2	3	4			
1-sided copying	1-sided copying		2	3	4	5			
1-sided copying	2-sided copying		2	3	4				
2-sided copying	1-sided copying		3	4	5				
2-sided copying	2-sided copying		3	4					

# Covers (2-sided copying of 1-sided originals)

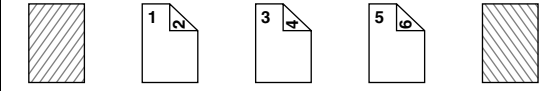
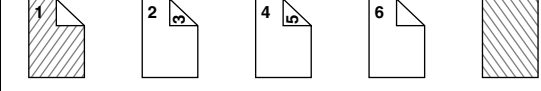
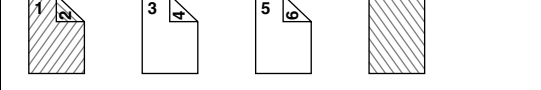
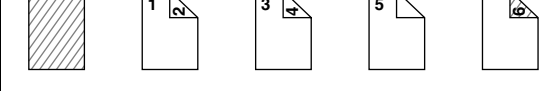
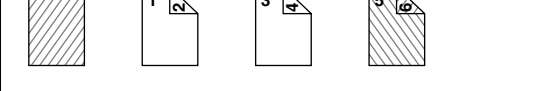
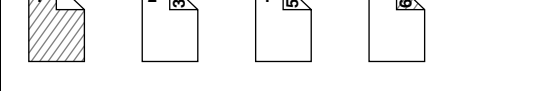
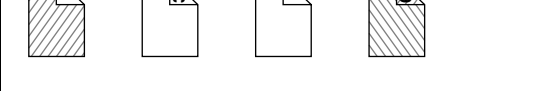
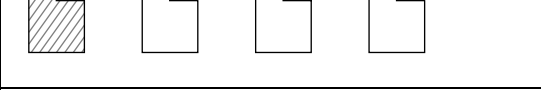

2-sided copies are made of the following 1-sided originals.























































1st page	2nd page	3rd page	4th page	5th page	6th page
1	2	3	4	5	6

Cover copying condition		Resulting copies
Front cover	Back cover	
No copying	No copying	
1-sided copying	No copying	
2-sided copying	No copying	
No copying	1-sided copying	
No copying	2-sided copying	
1-sided copying	1-sided copying	
1-sided copying	2-sided copying	
2-sided copying	1-sided copying	
2-sided copying	2-sided copying	

# Covers (1-sided copying of 2-sided originals)



1-sided copies are made of the following 2-sided originals.

































1st page	2nd page	3rd page
		

Cover copying condition		Resulting copies							
Front cover	Back cover								
No copying	No copying								
1-sided copying	No copying								
2-sided copying	No copying								
No copying	1-sided copying								
No copying	2-sided copying								
1-sided copying	1-sided copying								
1-sided copying	2-sided copying								
2-sided copying	1-sided copying								
2-sided copying	2-sided copying								

# Covers (2-sided copying of 2-sided originals)

2-sided copies are made of the following 2-sided originals.

1st page	2nd page	3rd page
		

Cover copying condition		Resulting copies
Front cover	Back cover	
No copying	No copying	    
1-sided copying	No copying	   
2-sided copying	No copying	   
No copying	1-sided copying	   
No copying	2-sided copying	   
1-sided copying	1-sided copying	  
1-sided copying	2-sided copying	  
2-sided copying	1-sided copying	  
2-sided copying	2-sided copying	  

## Inserts (copying of 1-sided originals)

1-sided and 2-sided copying is performed using the following 1-sided originals. The insert is added as the third page.

1st page	2nd page	3rd page	4th page	5th page	6th page
1	2	3	4	5	6

Insert copying condition	Resulting copies (one-sided copying)							Resulting copies (Two-sided copying)			
No copying	1	2		3	4	5	6	1		3	5
1-sided copying	1	2	3	4	5	6	1	3	4	6	
2-sided copying	1	2	3	5	6		1	3	5		

## Inserts (copying of 2-sided originals)

1-sided and 2-sided copying are performed using the following 2-sided originals.

1st page	2nd page	3rd page
1	3	5

Insert copying condition	Resulting copies (one-sided copying)							Resulting copies (Two-sided copying)			
No copying	1	2		3	4	5	6	1		3	5
1-sided copying	1	2	3	4	5	6	1	3	5		
2-sided copying	1	2	3	5	6		1	3	5		



**SHARP**<sup>®</sup>

MODEL: MX-2300N  
MX-2700N

# Printer Guide



---

---

# CONTENTS

ABOUT THIS MANUAL .....	3
• MANUALS PROVIDED WITH THE MACHINE ...	4
PRINTER FUNCTION OF THE MACHINE.....	5

## 1 PRINTING FROM WINDOWS

BASIC PRINTING PROCEDURE.....	6
• SELECTING THE PAPER .....	8
PRINTING WHEN THE USER AUTHENTICATION FUNCTION IS ENABLED.....	9
VIEWING PRINTER DRIVER HELP.....	11
SELECTING THE COLOR MODE .....	12
TWO-SIDED PRINTING .....	14
FITTING THE PRINT IMAGE TO THE PAPER .....	16
PRINTING MULTIPLE PAGES ON ONE PAGE .....	18
STAPLING OUTPUT/PUNCHING HOLES IN OUTPUT .....	20

## 2 CONVENIENT PRINTING FUNCTIONS IN WINDOWS

CONVENIENT FUNCTIONS FOR CREATING PAMPHLETS AND POSTERS.....	22
• CREATING A PAMPHLET (Pamphlet/Pamphlet Staple).....	22
• INCREASING THE MARGIN (Margin Shift).....	23
• CREATING A LARGE POSTER (Poster Printing) .....	23
FUNCTIONS TO ADJUST THE SIZE AND ORIENTATION OF DATA .....	24
• ROTATING THE PRINT IMAGE 180 DEGREES (Rotate 180 degrees).....	24
• ENLARGEMENT/REDUCTION (Zoom/XY-Zoom) .....	24
• REVERSING THE IMAGE (Mirror Image) .....	25
COLOR MODE ADJUSTMENT FUNCTION .....	26
• ADJUSTING THE BRIGHTNESS AND CONTRAST OF THE IMAGE (Color Adjustment) .....	26
• PRINTING LIGHT COLOR CHARACTERS OR LINES IN BLACK (Text To Black/Vector To Black) .....	26
• SELECTING COLOR SETTINGS TO MATCH THE IMAGE TYPE (Image Type).....	27

FUNCTIONS THAT COMBINE TEXT AND IMAGES .....	28
• ADDING A WATERMARK TO PRINTED PAGES (Watermark) .....	28
• PRINTING AN IMAGE OVER THE PRINT DATA (Image Stamp) .....	29
• CREATING OVERLAYS FOR PRINT DATA (Overlays).....	30
PRINT FUNCTIONS FOR SPECIAL PURPOSES ...	31
• PRINTING SPECIFIED PAGES ON DIFFERENT PAPER (Different Paper).....	31
• ADDING INSERTS WHEN PRINTING ON TRANSPARENCY FILM (Transparency Inserts) .....	32
• PRINTING A CARBON COPY (Carbon Copy)...	33
• PRINTING TEXT ON TABS OF TAB PAPER (Tab Printing) .....	34
CONVENIENT PRINTER FUNCTIONS .....	35
• USING TWO MACHINES TO PRINT A LARGE PRINT JOB (Tandem Print) .....	35
• USING THE DOCUMENT FILING FUNCTION (Retention/Document Filing).....	36
SAVING FREQUENTLY USED PRINT SETTINGS ..	37
• SAVING SETTINGS AT THE TIME OF PRINTING .....	37
• USING SAVED SETTINGS .....	39
CHANGING THE PRINTER DRIVER DEFAULT SETTINGS .....	40

## 3 PRINTING FROM A MACINTOSH

BASIC PRINTING PROCEDURE.....	42
• SELECT PAPER SETTINGS .....	42
• PRINT .....	43
• SELECTING THE PAPER .....	45
PRINTING WHEN THE USER AUTHENTICATION FUNCTION IS ENABLED.....	46

## **4 PRINTING WITHOUT THE PRINTER DRIVER**

<b>DIRECTLY PRINTING FROM THE MACHINE. . . . .</b>	<b>48</b>
• DIRECTLY PRINTING A FILE ON AN FTP SERVER. . . . .	48
• DIRECTLY PRINTING A FILE IN USB MEMORY . . . . .	50
<b>DIRECTLY PRINTING FROM A COMPUTER . . . . .</b>	<b>52</b>
• SUBMIT PRINT JOB . . . . .	52
• FTP PRINT . . . . .	52
• E-MAIL PRINT . . . . .	53
<b>PRINTING AN ENCRYPTED PDF FILE. . . . .</b>	<b>54</b>

## **5 CHANGING THE JOB QUEUE**

<b>GIVING A PRINT JOB PRIORITY / CANCELING A PRINT JOB . . . . .</b>	<b>55</b>
• GIVING A PRINT JOB PRIORITY . . . . .	55
• CANCELING A PRINT JOB . . . . .	56
<b>CHANGING TO ANOTHER PAPER SIZE AND PRINTING WHEN PAPER RUNS OUT . . . . .</b>	<b>57</b>

## **6 PRINTER DRIVER SPECIFICATIONS**

<b>PRINTER DRIVER SPECIFICATION LIST . . . . .</b>	<b>58</b>
--	-----------

---

---

# ABOUT THIS MANUAL

## Please note

---

- For information on installing the drivers and software cited in this manual, please refer to the separate Software Setup Guide.
- For information on your operating system, please refer to your operating system manual or the online Help function.
- The explanations of screens and procedures in this manual are primarily for Windows® XP in Windows® environments, and Mac OS X v10.3.9 in Macintosh environments. The screens may vary depending on the version of the operating system.
- Wherever "MX-xxxx" appears in this manual, please substitute your model name for "xxxx".
- Considerable care has been taken in preparing this manual. If you have any comments or concerns about the manual, please contact your dealer or nearest SHARP Service Department.
- This product has undergone strict quality control and inspection procedures. In the unlikely event that a defect or other problem is discovered, please contact your dealer or nearest SHARP Service Department.
- Aside from instances provided for by law, SHARP is not responsible for failures occurring during the use of the product or its options, or failures due to incorrect operation of the product and its options, or other failures, or for any damage that occurs due to use of the product.

## Warning

---

- Reproduction, adaptation or translation of the contents of the manual without prior written permission is prohibited, except as allowed under copyright laws.
- All information in this manual is subject to change without notice.

## Illustrations and the operation panel and touch panel shown in this manual

---

The peripheral devices are generally optional, however, some models include certain peripheral devices as standard equipment. The explanations in this manual assume that a right tray and stand/2 x 500 sheet paper drawer are installed. To further explain certain functions and uses, some explanations assume that additional peripheral devices are installed.

<p>The display screens, messages, and key names shown in this manual may differ from those on the actual machine due to product improvements and modifications.</p>
---

# MANUALS PROVIDED WITH THE MACHINE

Printed manuals and manuals stored in PDF format on the machine's hard drive are provided with the machine. When using the machine, read the appropriate manual for the feature you are using.

## Printed manuals

Manual name	Contents
<b>Safety Guide</b>	This manual contains instructions for using the machine safely and lists the specifications of the machine and its peripheral devices.
<b>Software Setup Guide</b>	This manual explains how to install the software and configure settings to use the machine as a printer or scanner.
<b>Quick Start Guide</b>	This manual provides easy-to-understand explanations of all the functions of the machine in a single volume. Detailed explanations of each of the functions can be found in the manuals in PDF format.
<b>Troubleshooting</b>	This manual explains how to remove paper misfeeds and provides answers to frequently asked questions regarding the operation of the machine in each mode. Refer to this manual when you have difficulty using the machine.
<b>Facsimile Quick Reference Guide</b>	This manual explains the basic procedures for using the fax function of the machine, and provides an overview of the features of the fax function, troubleshooting procedures, and specifications. For detailed information on using the fax function and the system settings for fax, see the "Facsimile Guide" in PDF format.





## Operation manuals in PDF format

The manuals in PDF format provide detailed explanations of the procedures for using the machine in each mode. To view the PDF manuals, download them from the hard drive in the machine. The procedure for downloading the manuals is explained in "How to download the manuals in PDF format" in the Quick Start Guide.

Manual name	Contents
<b>User's Guide</b>	This manual provides information, such as basic operation procedures, how to load paper, and machine maintenance.
<b>Copier Guide</b>	This manual provides detailed explanations of the procedures for using the copy function.
<b>Printer Guide (This manual)</b>	This manual provides detailed explanations of the procedures for using the printer function.
<b>Facsimile Guide</b>	This manual provides detailed explanations of the procedures for using the fax function and the "System Settings" that are related to fax.
<b>Scanner Guide</b>	This manual provides detailed explanations of the procedures for using the scanner function and the Internet fax function.
<b>Document Filing Guide</b>	This manual provides detailed explanations of the procedures for using the document filing function. The document filing function allows you to save the document data of a copy or fax job, or the data of a print job, as a file on the machine's hard drive. The file can be called up as needed.
<b>System Settings Guide</b>	This manual explains the "System Settings", which are used to configure a variety of parameters to suit the aims and the needs of your workplace. Current settings can be displayed or printed out from the "System Settings".

## Icons used in the manuals

The icons in the manuals indicate the following types of information:

	This alerts you to a situation where there is a risk of machine damage or failure.		This indicates the name of a system setting and provides a brief explanation of the setting. For detailed information on each system setting, see the System Settings Guide. <b>When "System Settings:" appears:</b> A general setting is explained. <b>When "System Settings (Administrator):" appears:</b> A setting that can only be configured by an administrator is explained.
	This provides a supplemental explanation of a function or procedure.		
	This explains how to cancel or correct an operation.		

---

---

# PRINTER FUNCTION OF THE MACHINE

This machine has a full color printing function which can be used in a Windows environment as a standard feature. The printer driver (PCL6 or PCL5c printer driver) can be installed from the provided CD-ROM to enable printing from your computer.

Expansion kits are available to enable the machine to be used in various environments.

For this reason, the following printer driver types are available for use with the machine. Please select a suitable printer driver depending on the expansion kits that are installed. The functions that are available vary depending on the printer driver type.

 [PRINTER DRIVER SPECIFICATION LIST](#) (page 58)

Environment	Printer driver type (machine configuration)	Remarks
Windows environment	PCL6, PCL5c (included standard with the machine)	The machine supports the Hewlett-Packard PCL6 and PCL5c printer control languages. It is recommended that you use the PCL6 printer driver. If you have a problem printing from older software using the PCL6 printer driver, use the PCL5c printer driver.
	PS (when the PS3 expansion kit is installed)	This printer driver supports the PostScript 3 page description language developed by Adobe Systems Incorporated and enables the machine to be used as a PostScript 3 compatible printer. (A PPD file is available if it is desired to use the Windows standard PS printer driver. To install the PPD file, see the Software Setup Guide.)
Macintosh environment		



The explanations in this manual of printing in a Windows environment generally use the PCL6 printer driver screens. The screens may vary slightly depending on the printer driver that you are using.

# 1

# PRINTING FROM WINDOWS

## BASIC PRINTING PROCEDURE

The following example explains how to print a document from "WordPad", which is a standard accessory program in Windows.

1

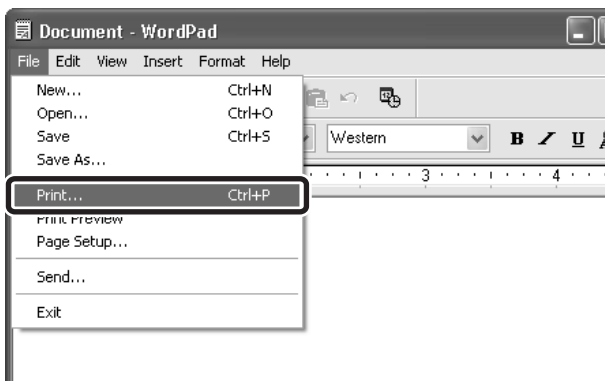

Select [Print] from the [File] menu of WordPad.



The menu used to execute printing may vary depending on the software application.

2

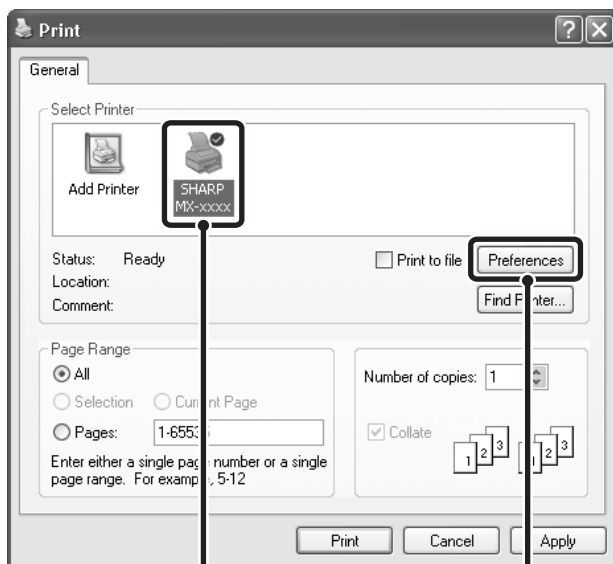

(1)

(2)

Open the printer driver properties window.

- (1) Select the printer driver of the machine.
  - If the printer drivers appear as icons, click the icon of the printer driver to be used.
  - If the printer drivers appear as a list, select the name of the printer driver to be used from the list.
- (2) Click the [Preferences] button.
  - In Windows 98/Me/NT 4.0, click the [Properties] button.
  - If you are using Windows 2000, the [Preferences] button does not appear. Click each tab in the "Print" dialog box to adjust the settings on that tab.



The button that is used to open the printer driver properties window (usually [Properties] or [Printing Preferences]) may vary depending on the software application.

3

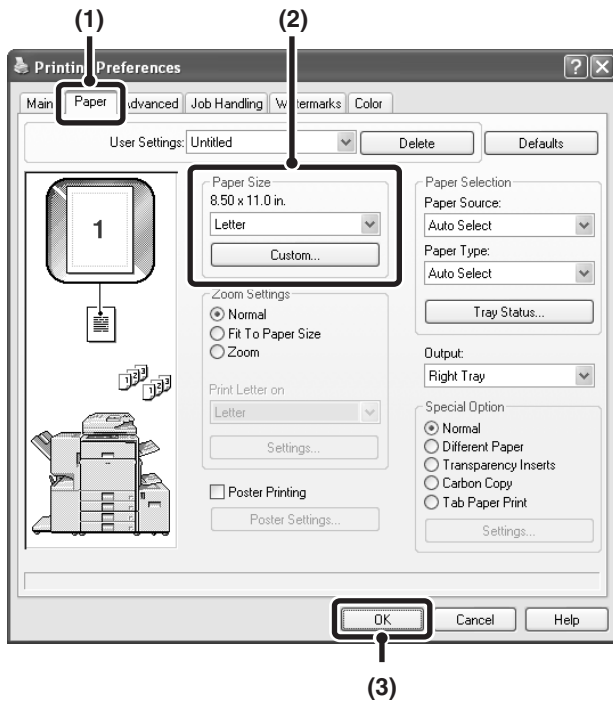

### Select print settings.

(1) Click the [Paper] tab.

(2) Select the paper size.

To select settings on other tabs, click the desired tab and then select the settings.

(3) Click the [OK] button.

4

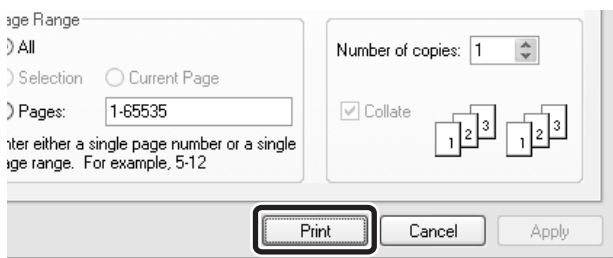

### Click the [Print] button.

Printing begins.

In Windows 98/Me/NT 4.0, click the [OK] button.



The print job is delivered to the output tray, with the position of the paper offset slightly from the previous job (other than the right tray).



# SELECTING THE PAPER

This section explains how to configure the "Paper Selection" setting on the [Paper] tab of the printer driver properties window.

Before printing, check the paper sizes, paper types, and paper remaining in the machine's trays. To view the most recent tray information, click the [Tray Status] button.

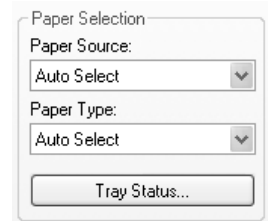

- **When [Auto Select] is selected in "Paper Source"**

The tray that has the size and type of paper selected in "Paper Size" and "Paper Type" on the [Paper] tab is automatically selected.

- **When other than [Auto Select] is selected in "Paper Source"**

The specified tray is used for printing regardless of the "Paper Size" setting.

- **When [Bypass Tray] is selected**

- Also select the "Paper Type". Check the bypass tray and make sure that the desired type of paper is loaded, and then select the appropriate "Paper Type" setting.



- Special media such as postcards or envelopes can also be placed in the bypass tray. For the procedure for loading paper and other media in the bypass tray, see "LOADING PAPER IN THE BYPASS TRAY" in the User's Guide.
- When "Enable Detected Paper Size in Bypass Tray" (disabled by factory default) or "Enable Selected Paper Type in Bypass Tray" (enabled by factory default) is enabled in the system settings (administrator), printing will not take place if the paper size or paper type specified in the printer driver is different from the paper size or paper type specified in the settings of the bypass tray.

- **When [Auto Select] is selected in "Paper Type"**

A tray with plain paper or recycled paper of the size specified in "Paper Size" is automatically selected. (The factory default setting is plain paper only.)

- **When other than [Auto Select] is selected in "Paper Type"**

A tray with the specified type of paper and the size specified in "Paper Size" is used for printing.



- **System Settings (Administrator): Exclude Bypass-Tray from Auto Paper Select**

- When [Auto Select] is selected in "Paper Selection", specify whether or not the paper in the bypass tray will be excluded from the paper that can be selected. This setting is disabled by factory default, and thus paper in the bypass tray is included in the paper that can be automatically selected. If special types of paper are frequently loaded in the bypass tray, it is recommended that this setting be enabled.

---

---

# PRINTING WHEN THE USER AUTHENTICATION FUNCTION IS ENABLED

When the user authentication function is enabled in the machine's system settings (administrator), your user information (login name, password, etc.) must be entered in the setup screen of the printer driver before you can print. The information that must be entered varies depending on the authentication method being used, so check with the administrator of the machine before printing.

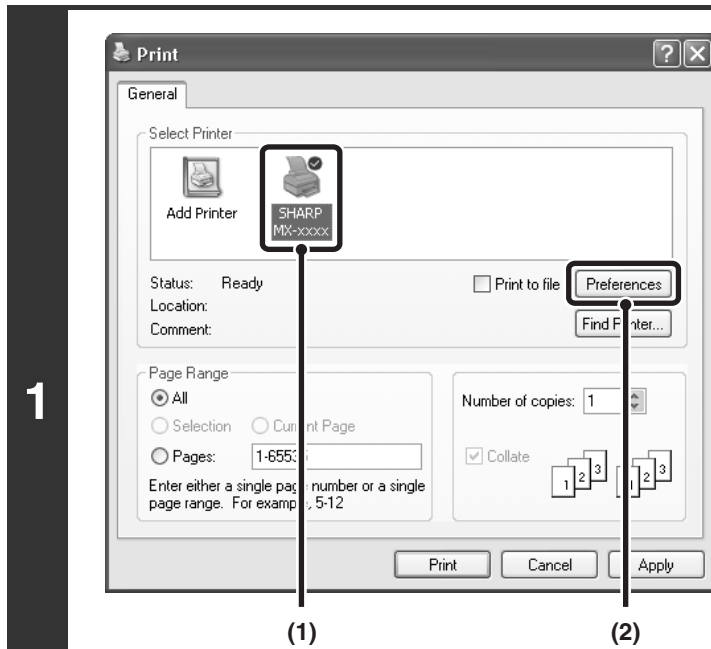

**Open the printer driver properties window from the print window of the software application.**

- (1) Select the printer driver of the machine.
- (2) Click the [Preferences] button.



The button that is used to open the printer driver properties window (usually [Properties] or [Printing Preferences]) may vary depending on the software application.

2

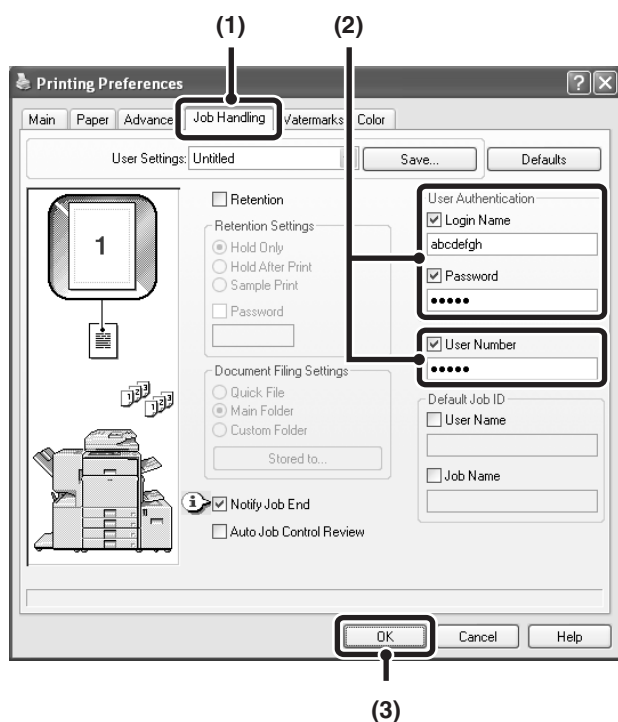

## Enter your login name and password.

(1) Click the [Job Handling] tab.

(2) Enter your user information.

- When authentication is by login name/password  
Select the [Login Name] and [Password] checkboxes so that checkmarks  appear, and enter your login name and password. Enter 1 to 32 characters for the password.
- When authentication is by user number  
Click the [User Number] checkbox  and enter a user number (5 to 8 digits).

(3) Click the [OK] button.



To have a confirmation window appear before printing starts, select the [Auto Job Control Review] checkbox so that a checkmark  appears.

3

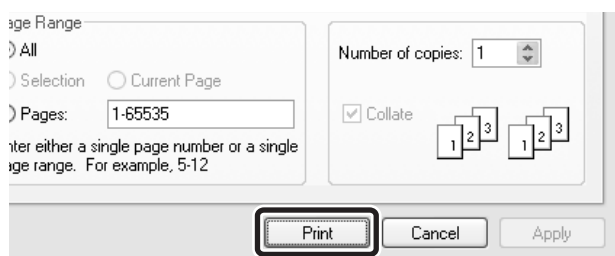

## Start printing.



- Normally printing is possible without entering your user information. (In this case, the printed pages will be added to the "Others" count.) When printing by invalid users is prohibited in the system settings (administrator), printing is not permitted when user information is not entered or incorrect information is entered.
  - The user authentication function of the machine cannot be used when the PPD file\* is installed and the Windows standard PS printer driver is used. For this reason, printing will not be possible if printing by invalid users is prohibited in the system settings (administrator).
- \* The PPD file enables the machine to print using the standard PS printer driver of the operating system.



### System Settings (Administrator): Disable Printing by Invalid User

This is used to prohibit printing of print jobs by users whose user information is not stored in the machine. When this function is enabled, printing is not allowed when user information is not entered or incorrect information is entered.

# VIEWING PRINTER DRIVER HELP

When selecting settings in the printer driver, you can display Help to view explanations of the settings.

**1**

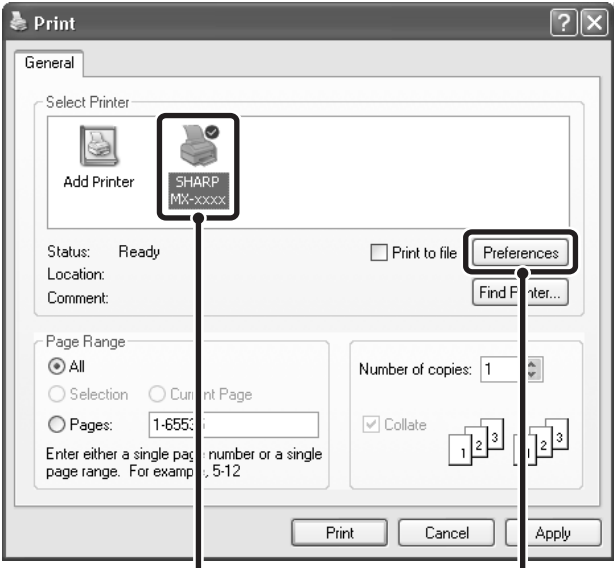

**Open the printer driver properties window from the print window of the software application.**

- (1) Select the printer driver of the machine.
- (2) Click the [Preferences] button.

 The button that is used to open the printer driver properties window (usually [Properties] or [Printing Preferences]) may vary depending on the software application.

**2**

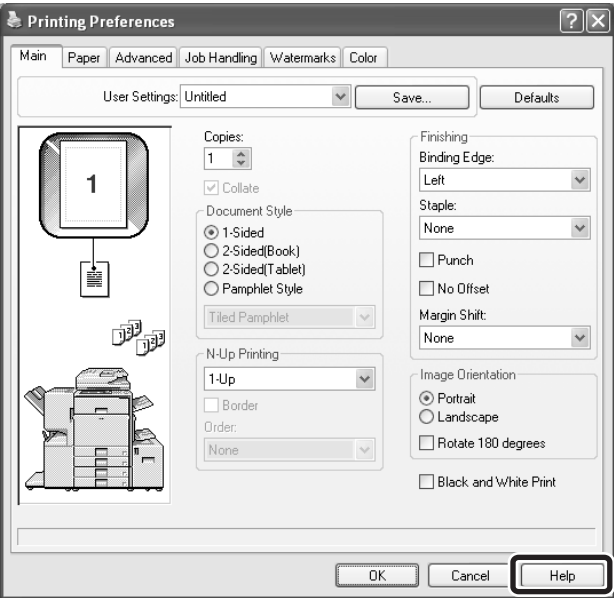

**Click the [Help] button.**

## Pop-up help

To view Help for a setting, click the  button in the upper right-hand corner of the window and then click the setting. You can also view the same Help by right-clicking the setting and clicking the Help box that appears.

## Information icon

Some restrictions exist on the combinations of settings that can be selected in the printer driver properties window. When a restriction exist on the selected setting, an information icon () will appear next to the setting. Click the icon to view an explanation of the restriction.

---

---

# SELECTING THE COLOR MODE

This section explains how to select the "Color Mode" on the [Color] tab of the printer driver properties window. The following three selections are available for the "Color Mode".

**Automatic:** The machine automatically determines whether each page is color or black and white and prints the page accordingly. Pages with colors other than black and white are printed using Y (Yellow), M (Magenta), C (Cyan) and Bk (Black) toner. Pages that are only black and white are printed using Bk (Black) toner only. This is convenient when printing a document that has both color and black and white pages, however, the printing speed is slower.

**Color:** All pages are printed in color. Both color data and black and white data are printed using Y (Yellow), M (Magenta), C (Cyan) and Bk (Black) toner.

**Black and White:** All pages are printed in black and white. Color data such as images or materials for a presentation are printed using black toner only. This mode helps conserve color toner when you do not need to print in color, such as when proofreading or checking the layout of a document.

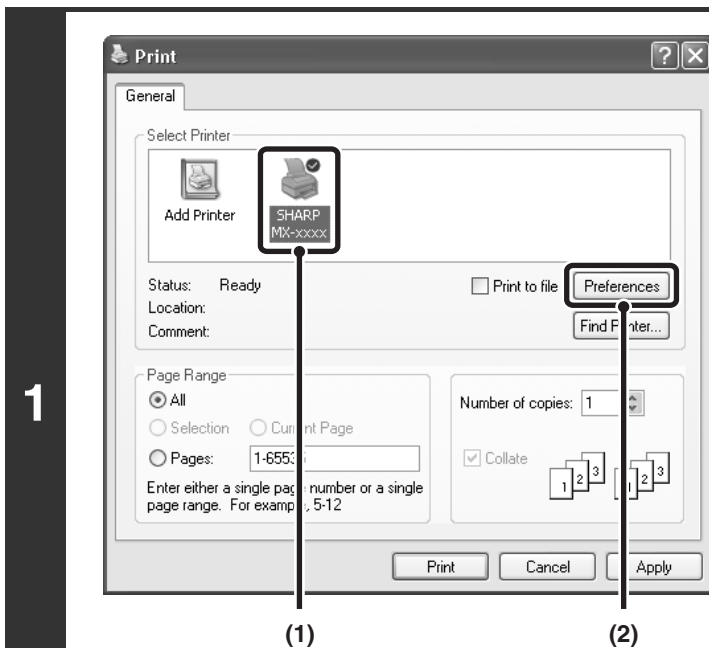

**Open the printer driver properties window from the print window of the software application.**

- (1) Select the printer driver of the machine.
- (2) Click the [Preferences] button.



The button that is used to open the printer driver properties window (usually [Properties] or [Printing Preferences]) may vary depending on the software application.

2

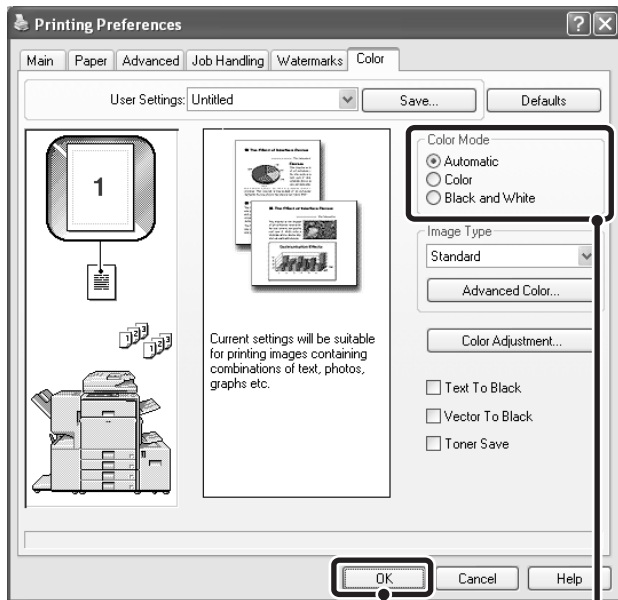

(2)

(1)

Select the color mode.

(1) Select the "Color Mode" that you wish to use.

(2) Click the [OK] button.

3

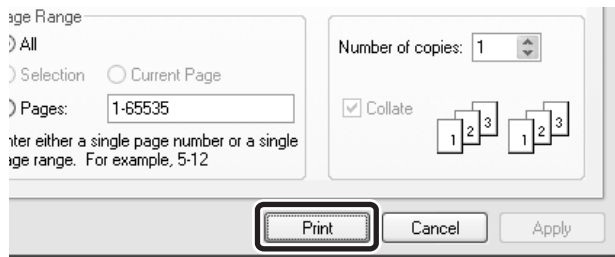

Start printing.

## BLACK AND WHITE PRINTING

Black and white printing can be selected on the [Main] tab as well as on the [Color] tab. Click the [Black and White Print] checkbox on the [Main] tab so that a checkmark appears .

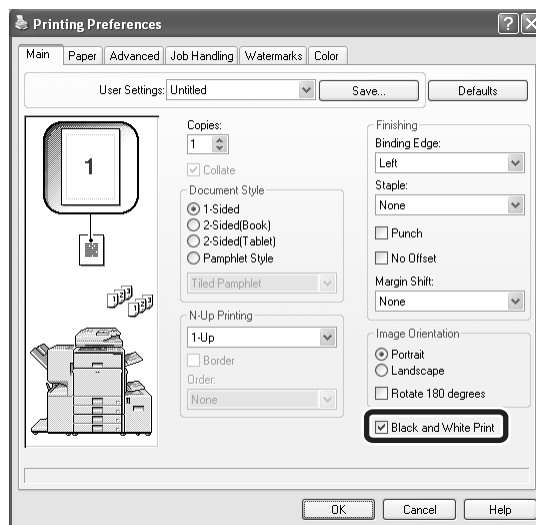

The [Black and White Print] checkbox on the [Main] tab and the "Color Mode" setting on the [Color] tab are linked together. When the [Black and White Print] checkbox is selected  on the [Main] tab, [Black and White] is also selected on the [Color] tab.

# TWO-SIDED PRINTING

The machine can print on both sides of the paper. This function is useful for many purposes, and is particularly convenient when you want to create a simple pamphlet. Two-sided printing also helps conserve paper.

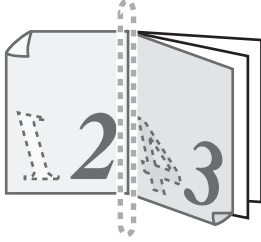
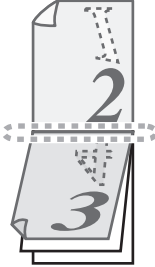
Printing result	
2-Sided (Book)	2-Sided (Tablet)
	
The pages are printed so that they can be bound at the side.	The pages are printed so that they can be bound at the top.

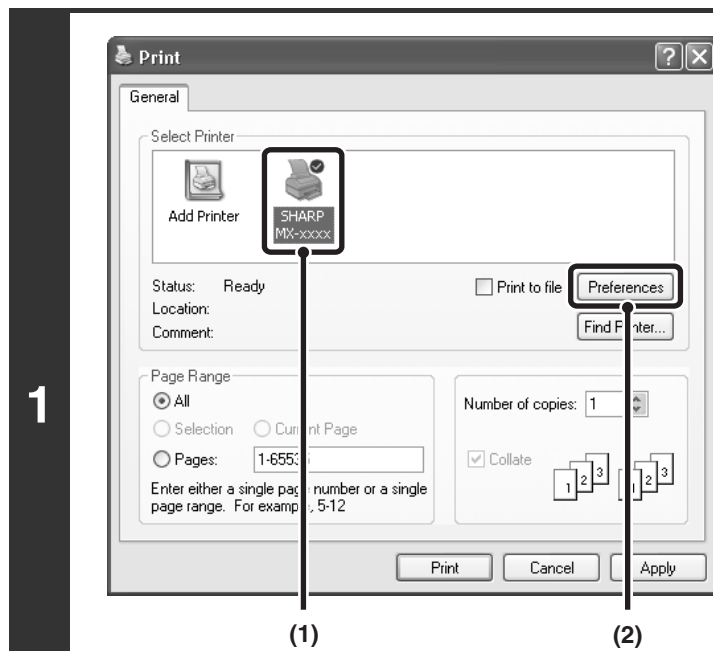

**Open the printer driver properties window from the print window of the software application.**

- (1) Select the printer driver of the machine.
- (2) Click the [Preferences] button.



The button that is used to open the printer driver properties window (usually [Properties] or [Printing Preferences]) may vary depending on the software application.

2

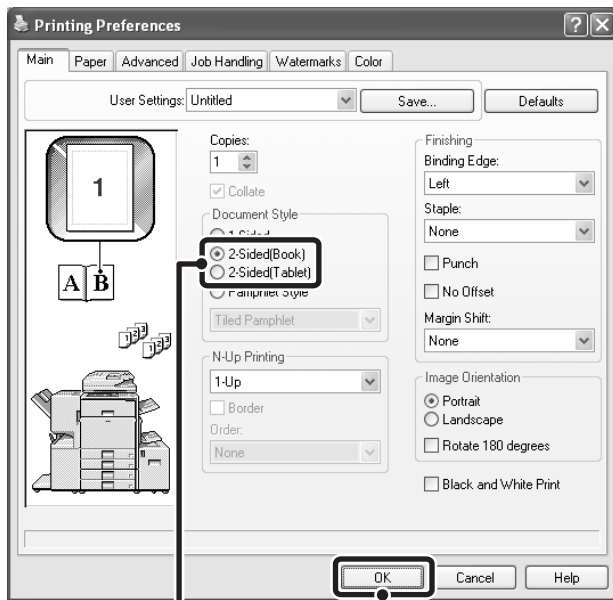

(1)

(2)

### Select 2-sided printing.

(1) Select [2-Sided(Book)] or [2-Sided(Tablet)].

(2) Click the [OK] button.

3

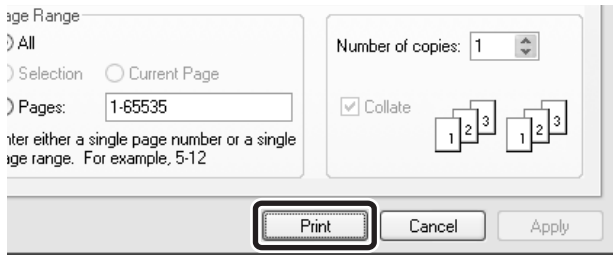

### Start printing.



---

---

# FITTING THE PRINT IMAGE TO THE PAPER

This function is used to automatically enlarge or reduce the printed image to the size of the paper loaded in the machine. This is convenient for such purposes as enlarging a letter or A4 size document to ledger or A3 size paper to make it easier to view, and to print when the same size of paper as the document image is not loaded in the machine.

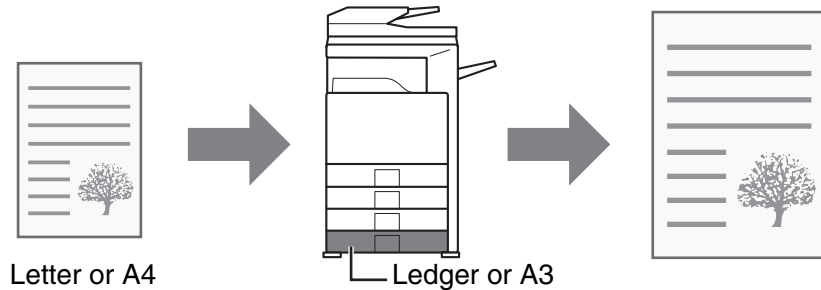

The explanation below assumes that you intend to print a letter size document on ledger size paper.

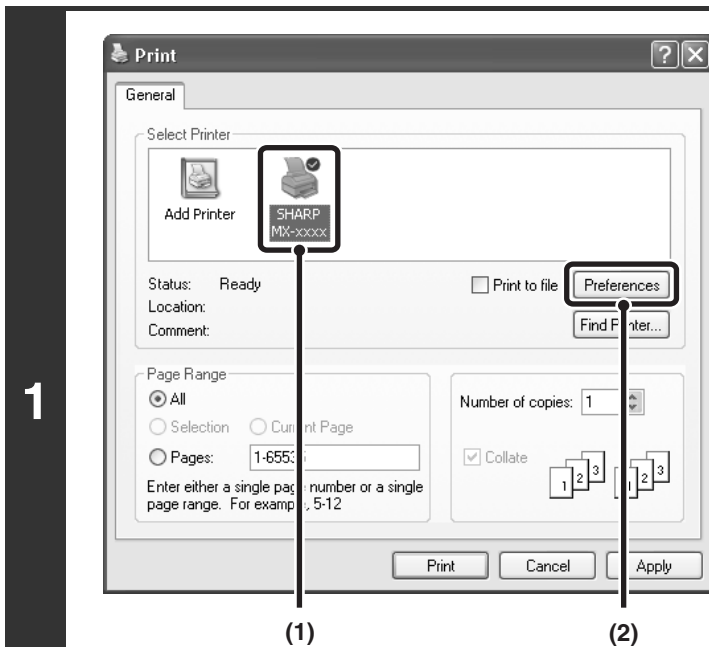

**Open the printer driver properties window from the print window of the software application.**

- (1) Select the printer driver of the machine.
- (2) Click the [Preferences] button.



The button that is used to open the printer driver properties window (usually [Properties] or [Printing Preferences]) may vary depending on the software application.

2

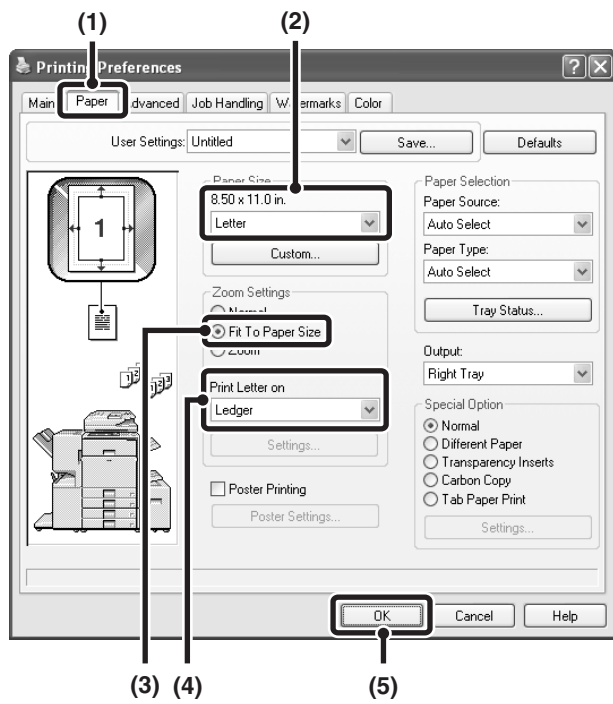

### Select Fit to Page.

- (1) Click the [Paper] tab.
- (2) Select the paper size of the print image (for example: Letter).
- (3) Select [Fit To Paper Size].
- (4) Select the actual paper size to be used for printing (for example: Ledger).
- (5) Click the [OK] button.

3

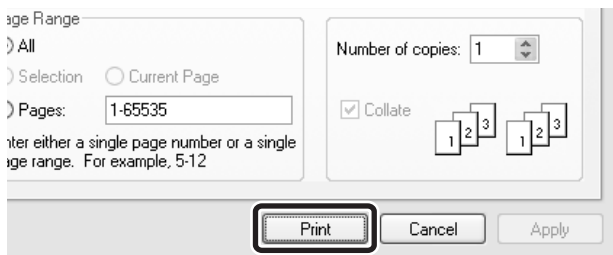

### Start printing.





# PRINTING MULTIPLE PAGES ON ONE PAGE

This function can be used to reduce a print image and print multiple pages on a single sheet of paper.

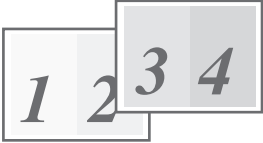
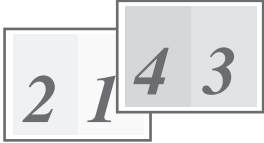
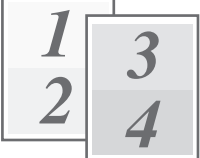
This is convenient when you want to print multiple images such as photos on a single sheet of paper, and when you want to conserve paper. This function can also be used in combination with 2-sided printing for maximum conservation of paper.

The print results of [2-Up] and [4-Up] are shown below for each selection in the "Order" menu.

N-Up	Print results		
	Left to Right	Right to Left	Top To Bottom (when the printing orientation is landscape)
[2-Up]			

N-Up	Right, and Down	Down, and Right	Left, and Down	Down, and Left
[4-Up]				



The order of 6-Up, 8-Up, 9-Up, and 16-Up is the same as 4-Up.  
The order can be viewed in the print image in the printer driver properties window.

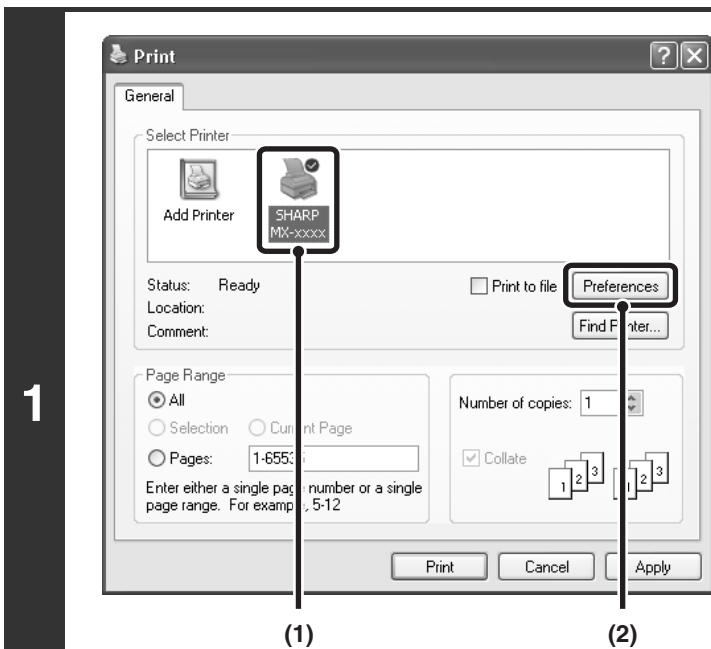

Open the printer driver properties window from the print window of the software application.

- (1) Select the printer driver of the machine.
- (2) Click the [Preferences] button.



The button that is used to open the printer driver properties window (usually [Properties] or [Printing Preferences]) may vary depending on the software application.

2

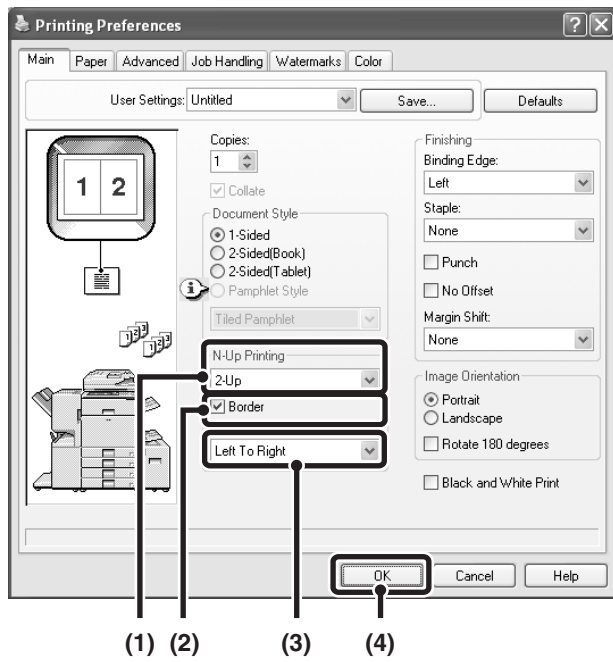

### Select N-Up Printing.

- (1) Select the number of pages per sheet.
- (2) If you wish to print borderlines, click the [Border] checkbox so that a checkmark  appears.
- (3) Select the order of the pages.
- (4) Click the [OK] button.

3

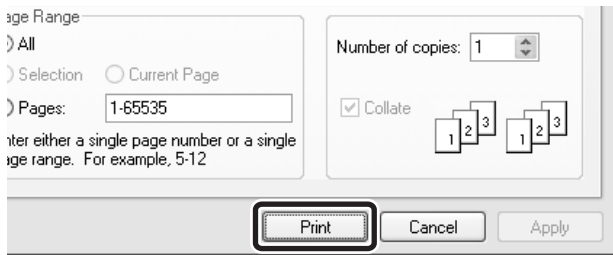

### Start printing.





# STAPLING OUTPUT/PUNCHING HOLES IN OUTPUT

## Staple function

The staple function can be used to staple output.

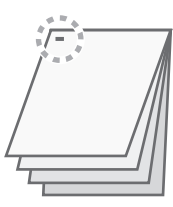

This function saves considerable time when preparing materials such as handouts for a meeting. The staple function can also be used in combination with 2-sided printing to create materials with a more sophisticated appearance.

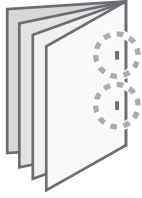
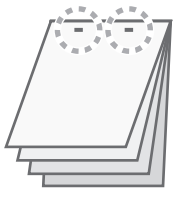
Stapling positions and the number of staples can be selected to obtain the following stapling results.

Staples	Left	Right	Top
[1 Staple]			
[2 Staples]			

## Punch function

To punch holes in the output, click the [Punch] checkbox so that a checkmark  appears. Punch hole positions can be set using [Binding Edge].

Left	Right	Top
		



- To use the staple function, a finisher or saddle stitch finisher is required.
- To use the punch function, a punch unit must be installed on the finisher or saddle stitch finisher.
- The number of holes that can be punched and the spacing between the holes varies depending on the installed punch module.
- The maximum number of sheets that can be stapled is 50 (25 sheets for Foolscap, B4, or larger sizes).
- The staple function and offset function cannot be used at the same time.
- When the finisher is disabled in the machine's system settings (administrator), the staple function and punch function cannot be used.
- When the staple function or the punch function is disabled in the machine's system settings (administrator), stapling or punching is not possible.
- For information on pamphlet stapling, see "[CREATING A PAMPHLET \(Pamphlet/Pamphlet Staple\)](#)" (page 22).

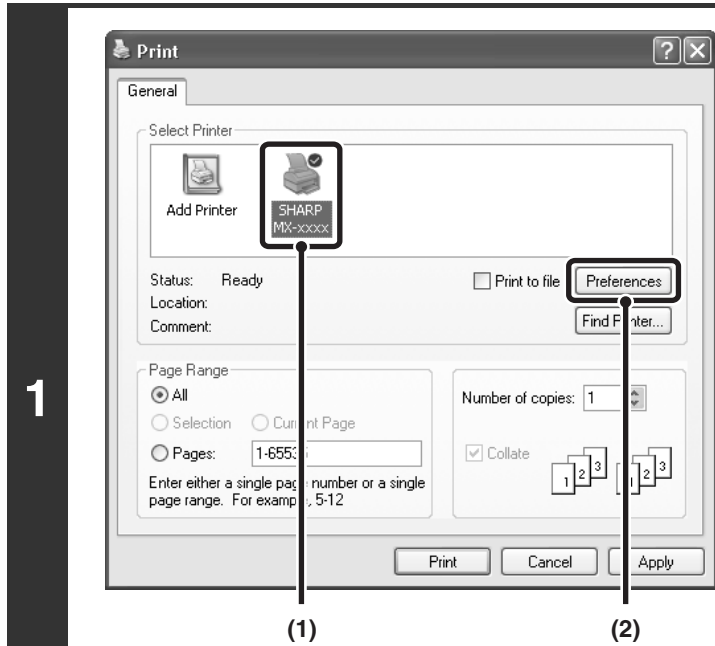

Open the printer driver properties window from the print window of the software application.

- (1) Select the printer driver of the machine.
- (2) Click the [Preferences] button.

The button that is used to open the printer driver properties window (usually [Properties] or [Printing Preferences]) may vary depending on the software application.

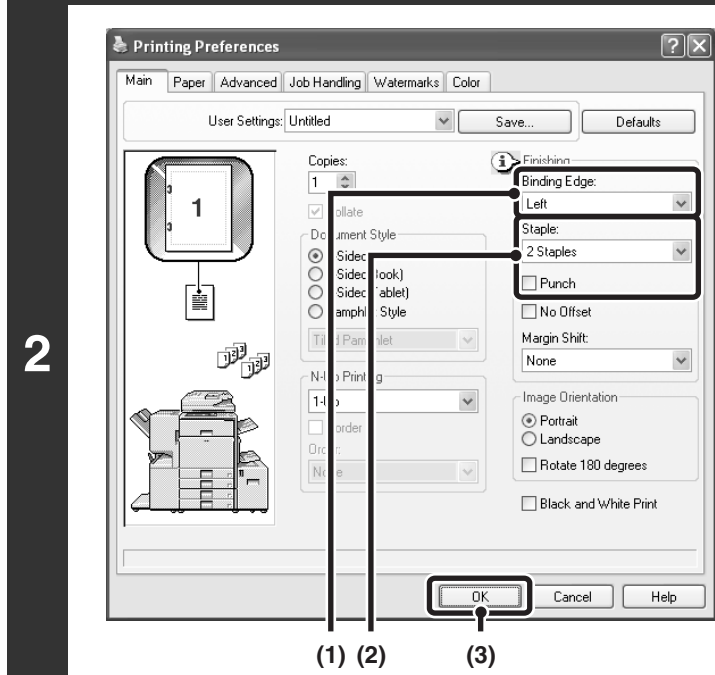

Select the staple function or the punch function.

- (1) Select the binding edge.
- (2) Select the staple function or the punch function.
  - For the staple function, select the number of staples in the "Staple" menu.
  - For the punch function, click the [Punch] checkbox so that a checkmark  appears.
- (3) Click the [OK] button.

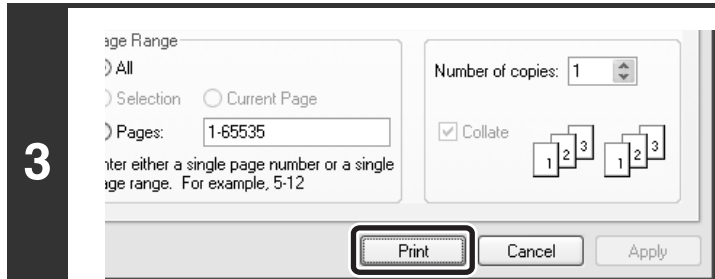

Start printing.

# 2

## CONVENIENT PRINTING FUNCTIONS IN WINDOWS

This section explains convenient functions for specific printing objectives. The procedures for selecting these functions assume that the printer driver properties window has been opened from the print window of your application and that basic settings such as the paper size have been selected. When the settings are completed, return to the print window and begin printing.

 [BASIC PRINTING PROCEDURE](#) (Page 6)



For details on printer driver settings used for each printing function, view printer driver Help.

## CONVENIENT FUNCTIONS FOR CREATING PAMPHLETS AND POSTERS

### CREATING A PAMPHLET (Pamphlet/Pamphlet Staple)

The pamphlet function prints on the front and back of each sheet of paper so that the sheets can be folded and bound to create a pamphlet. This is convenient when you wish to compile printed output into a pamphlet. When a saddle stitch finisher is installed and saddle stitch printing and the staple function are selected, the output is automatically folded at the center. This allows you to conveniently use the output as a handout or pamphlet without the need for any further work.

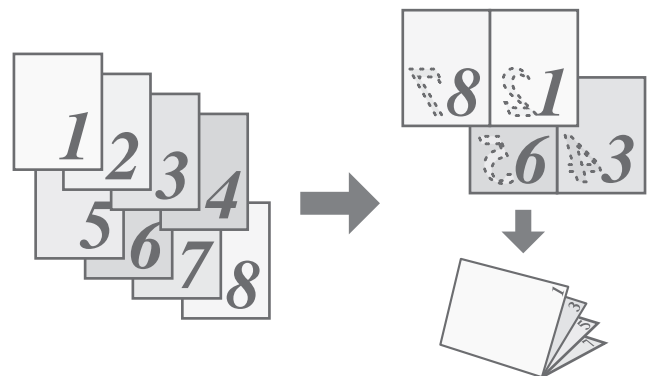

#### Selecting the settings:



The settings are on the [Main] tab.

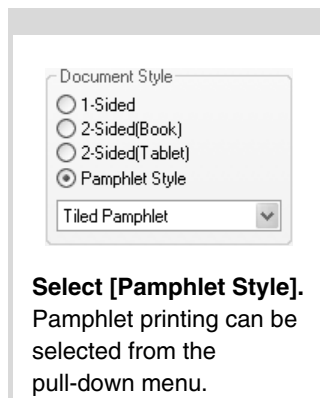

Select [Pamphlet Style]. Pamphlet printing can be selected from the pull-down menu.

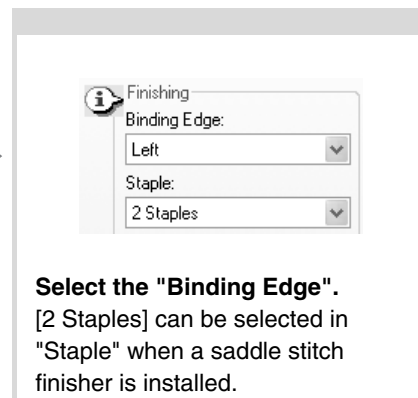

Select the "Binding Edge". [2 Staples] can be selected in "Staple" when a saddle stitch finisher is installed.

# INCREASING THE MARGIN (Margin Shift)

This function is used to shift the print image to increase the margin at the left, right, or top of the paper. This is convenient when you wish to staple or punch the output, but the binding position overlaps the text. When a finisher or saddle stitch finisher is installed, you can use the staple function or the punch function with this function.

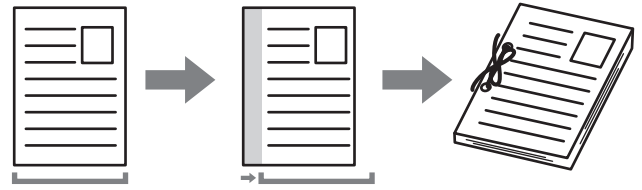

## Selecting the settings:

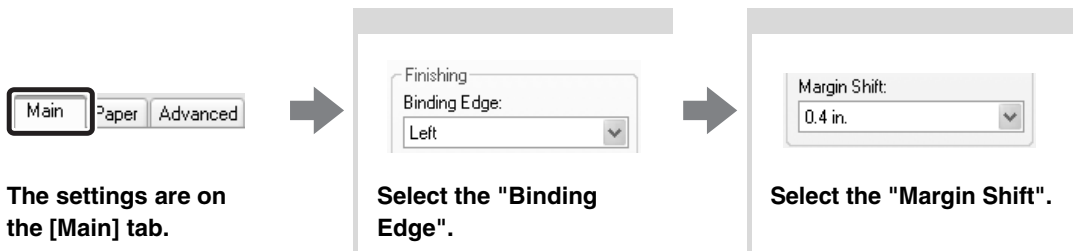

# CREATING A LARGE POSTER (Poster Printing)

One page of print data can be enlarged and printed in sections on multiple sheets of paper (4 sheets (2 x 2), 9 sheets (3 x 3) or 16 sheets (4 x 4)). This makes it possible to attach the sheets together to create a large poster. To enable precise alignment of the edges of the sheets during attachment, borderlines can be printed and overlapping edges can be created (overlap function).

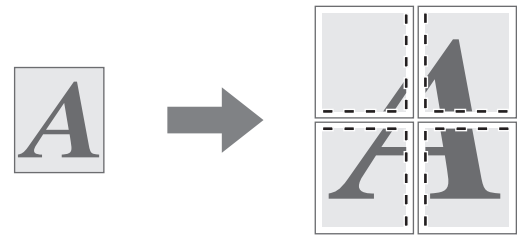

## Selecting the settings:

(This function can be used when the PCL6 or PS printer driver is used.)

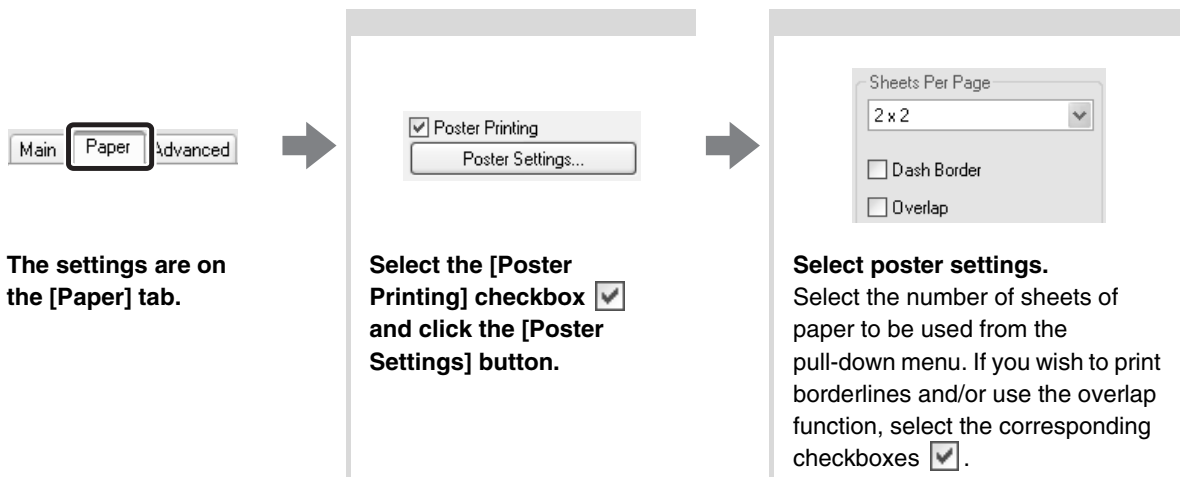



---

---

# FUNCTIONS TO ADJUST THE SIZE AND ORIENTATION OF DATA

## ROTATING THE PRINT IMAGE 180 DEGREES (Rotate 180 degrees)

This feature enables the image to be rotated 180 degrees so that it can be printed correctly on paper that can only be loaded in one orientation (such as envelopes or paper with punch holes).

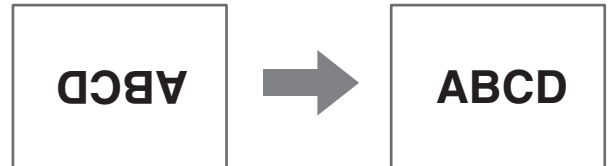

### Selecting the settings:

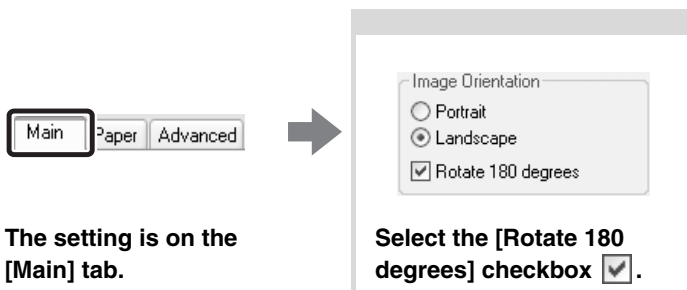

## ENLARGEMENT/REDUCTION (Zoom/XY-Zoom)

This function is used to enlarge or reduce the image to a selected percentage. This allows you to add margins to the paper by slightly reducing the image, or to enlarge a small image.

When using the PS printer driver, you can set the width and length percentages separately to change the proportions of the image. (XY-Zoom)

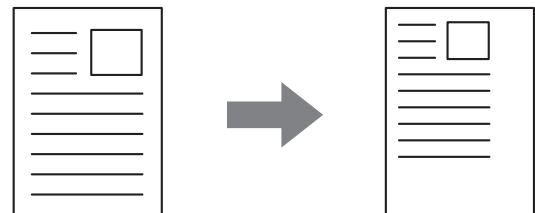

### Selecting the settings:

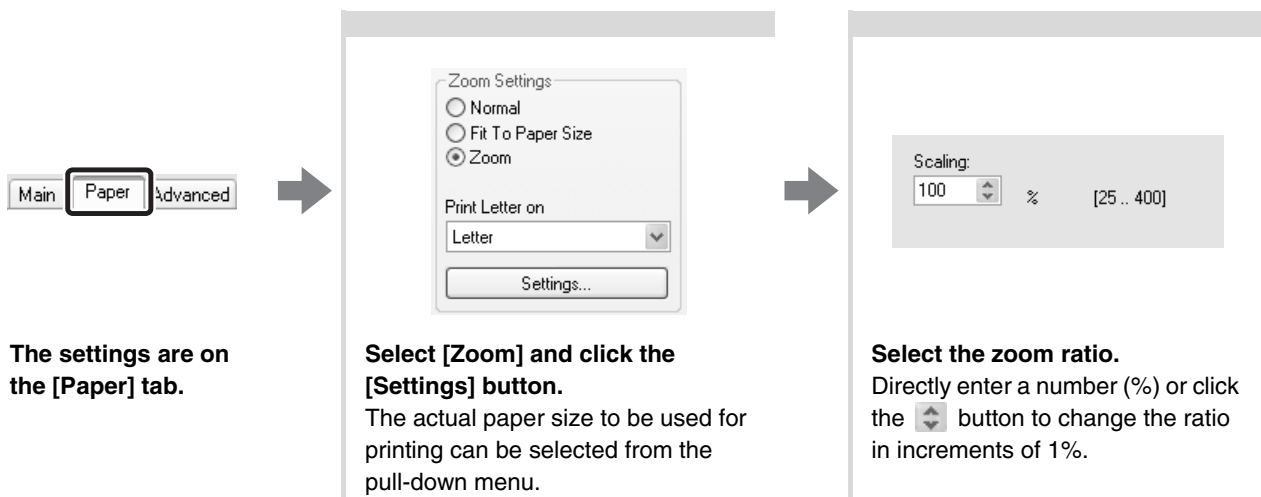

# REVERSING THE IMAGE (Mirror Image)

The image can be reversed to create a mirror image.  
This function can be used to conveniently print a design  
for a woodblock print or other printing medium.

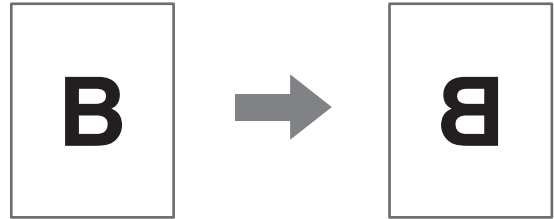

## Selecting the settings:

(This function can be used when the PS printer driver is used.)



The settings are on the  
[Advanced] tab.

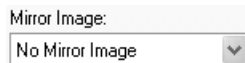

### Select the Mirror Image settings.

If you wish to reverse the image  
horizontally, select [Horizontal]. If  
you wish to reverse the image  
vertically, select [Vertical].

---

---

# COLOR MODE ADJUSTMENT FUNCTION

## ADJUSTING THE BRIGHTNESS AND CONTRAST OF THE IMAGE (Color Adjustment)

The brightness and contrast can be adjusted in the print settings when printing a photo or other image. These settings can be used for simple corrections when you do not have image editing software installed on your computer.

### Selecting the settings:

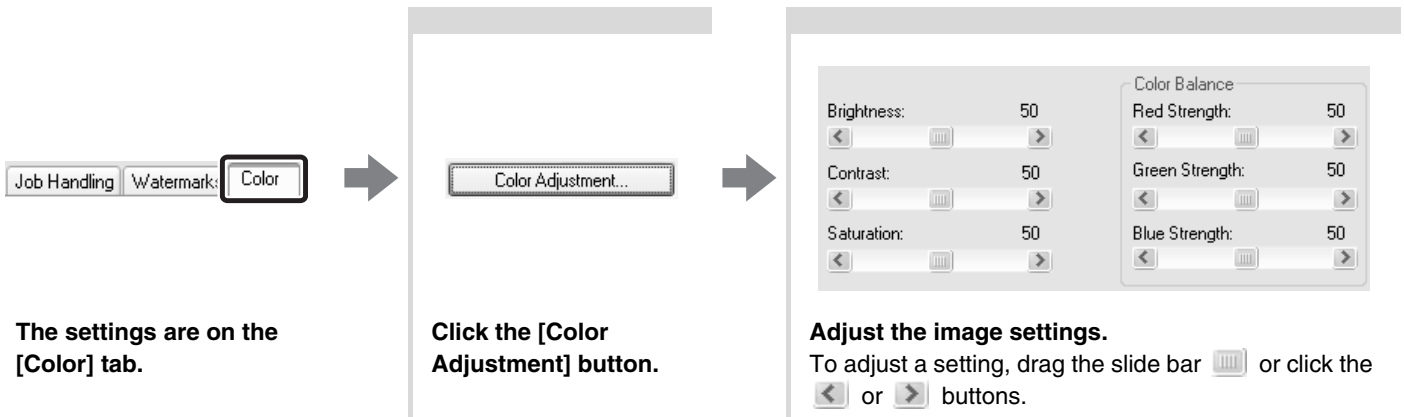

## PRINTING LIGHT COLOR CHARACTERS OR LINES IN BLACK (Text To Black/Vector To Black)

When printing a color image in grayscale, color text and lines that are faint can be printed in black. (Raster data such as bitmap images cannot be adjusted.) This allows you to bring out color text and lines that are faint and difficult to see when printed in grayscale.

- [Text To Black] can be selected to print all text other than white text in black.
- [Vector To Black] can be selected to print all vector graphics other than white lines and areas in black.

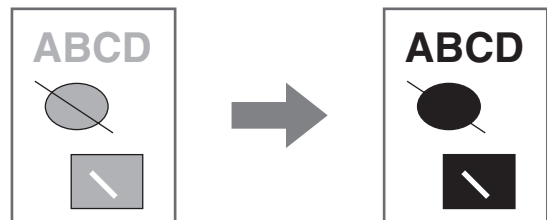

### Selecting the settings:

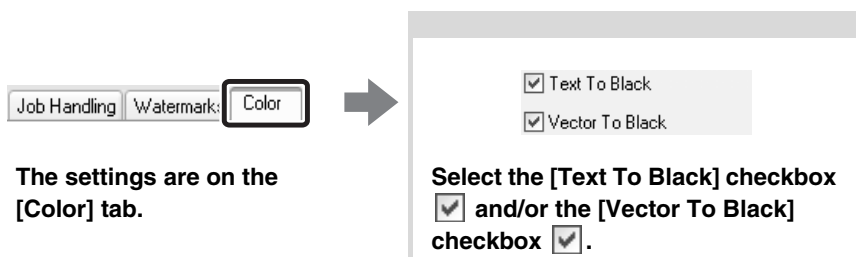

# SELECTING COLOR SETTINGS TO MATCH THE IMAGE TYPE (Image Type)

Preset color settings are available in the machine's printer driver for [Graphics], [Photo], and other image types. These enable printing using the most suitable color settings for the color image type.

If you wish to select advanced settings, click the [Advanced Color] button. The advanced color settings allow you to configure settings to match the printing purpose of the color image, such as color management settings and the screening setting that adjusts the expression of color tones.

The following items can be configured in the advanced color management settings:

- [Windows ICM] checkbox: Color management method
- "Source Profile": Select the color profile used to display the image on the computer screen.
- "Rendering Intent": Select the color profile used to display the image on the computer screen.
- "Screening": Select the most suitable image processing method for the image being printed.
- "Neutral Gray": Select the toner color used to print gray areas.
- "Print Priority": Select whether you wish to give priority to image quality or speed when printing.

## Selecting the settings:

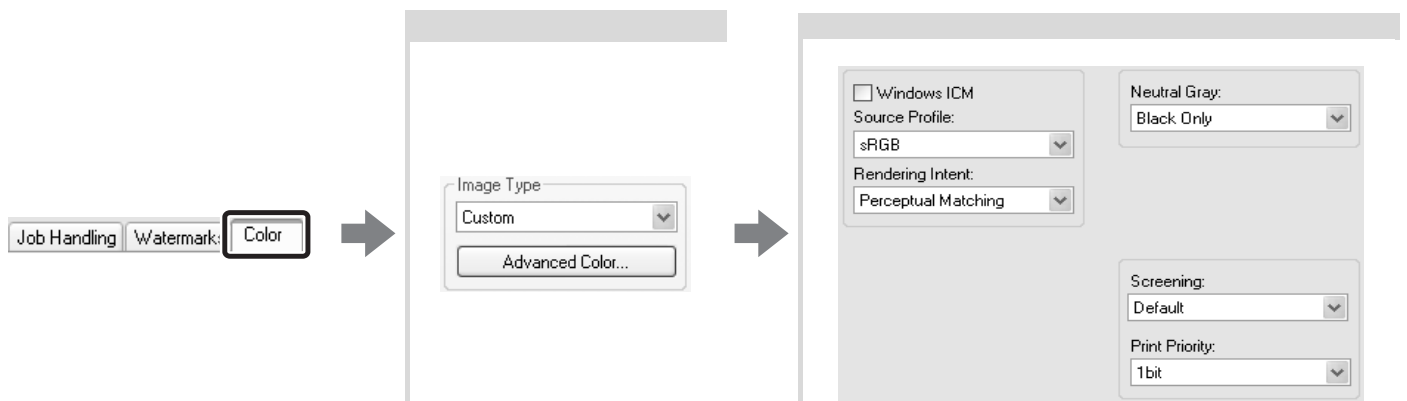

The settings are on the [Color] tab.

**Select the color image type.**  
A document type to match your purpose can be selected from the pull-down menu. If you wish to select advanced settings, click the [Advanced Color] button.

**Select the advanced color settings.**  
If you wish to perform color management using Windows ICM in your operating system, select the [Windows ICM] checkbox . To configure advanced color management settings such as "Source Profile", select the desired settings from the menus.

To configure all the advanced color settings, select [Custom] from the pull-down menu and then click the [Advanced Color] button.

The settings that can be selected vary depending on the printer driver type. The PS printer driver also allows you to select the Black Overprint function, which prevents whitening of the outline of black text, and the CMYK Simulation function, which allows you to perform color correction when using special colors.

---

---

# FUNCTIONS THAT COMBINE TEXT AND IMAGES

## ADDING A WATERMARK TO PRINTED PAGES (Watermark)

Faint shadow-like text can be added to the background of the printed image as a watermark. The size, color, density, and angle of the watermark text can be adjusted. The text can be selected from a pre-stored list, or entered to create an original watermark.

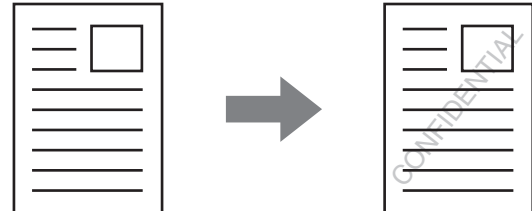

### Selecting the settings:

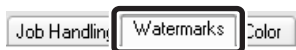
A screenshot of the 'Watermark' settings dialog box. It features a pull-down menu labeled 'Watermark' with 'None' selected. Below the menu are 'Add' and 'Delete' buttons. A 'Text:' label is followed by an empty text input field. At the bottom is an 'Edit...' button.

The settings are on the [Watermarks] tab.

#### Select the watermark setting.

Select a stored water mark from the pull-down menu. You can click the [Edit] button to edit the font color and select other detailed settings.



#### If you wish to create a new watermark...

Enter the text of the watermark in the text box and click the [Add] button.

# PRINTING AN IMAGE OVER THE PRINT DATA (Image Stamp)

A bitmap or JPEG image stored on your computer can be printed over the print data. The size, position, and angle of the image can be adjusted. This feature can be used to "stamp" the print data with a frequently used image or an icon of your own creation.

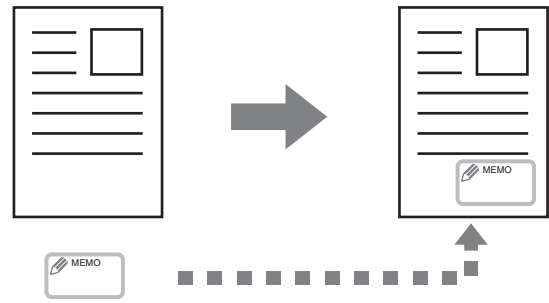

## Selecting the settings:

(This function can be used when the PCL6 or PS printer driver is used.)

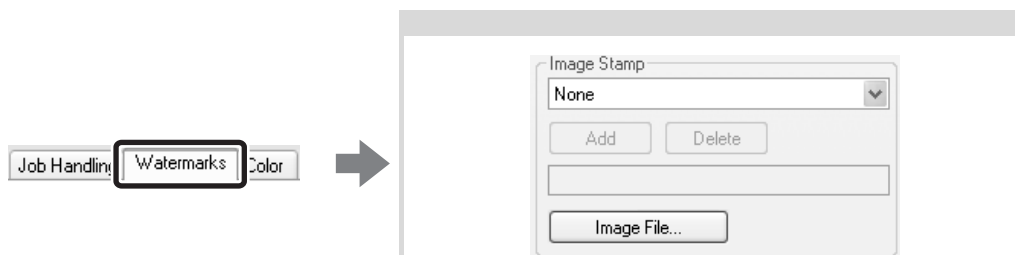

The settings are on the [Watermarks] tab.

**Select the image stamp setting.**  
Select a stored image stamp from the pull-down menu.

**If you wish to create a new image stamp...**  
Select an image file and then click the [Add] button.

# CREATING OVERLAYS FOR PRINT DATA (Overlays)

The print data can be printed in a previously created overlay. By creating table rulings or a decorative frame in an application different from the text and registering the data as an overlay file, an attractive print result can be easily obtained without the need for complex manipulations.

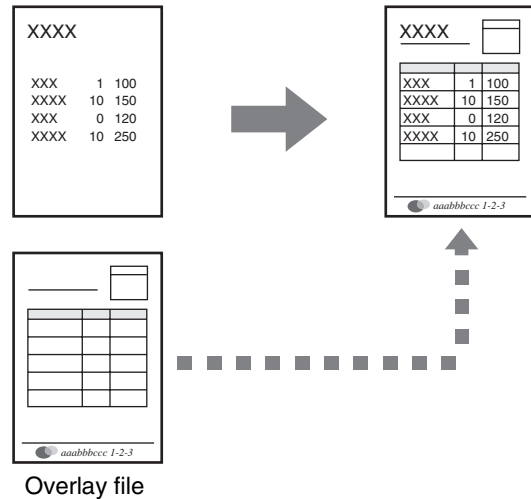

## Selecting the settings:

### Create an overlay file



The settings are on the **[Advanced]** tab. Configure the printer driver settings from the software application used to create the overlay file.

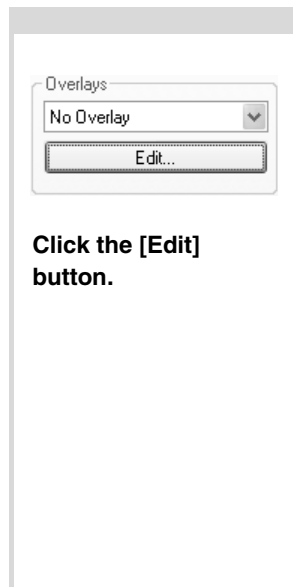

Click the **[Edit]** button.

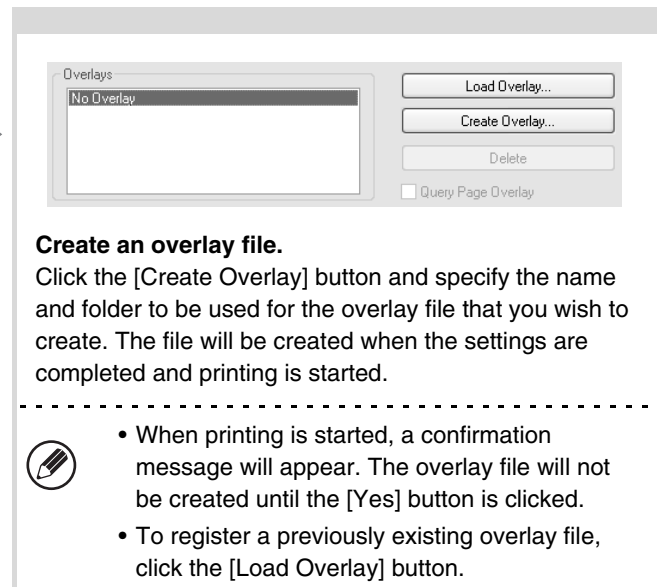

### Create an overlay file.

Click the **[Create Overlay]** button and specify the name and folder to be used for the overlay file that you wish to create. The file will be created when the settings are completed and printing is started.



- When printing is started, a confirmation message will appear. The overlay file will not be created until the **[Yes]** button is clicked.
- To register a previously existing overlay file, click the **[Load Overlay]** button.

### Print with an overlay file



The settings are on the **[Advanced]** tab. Configure the printer driver settings from the application that you wish to use to print using the overlay file.

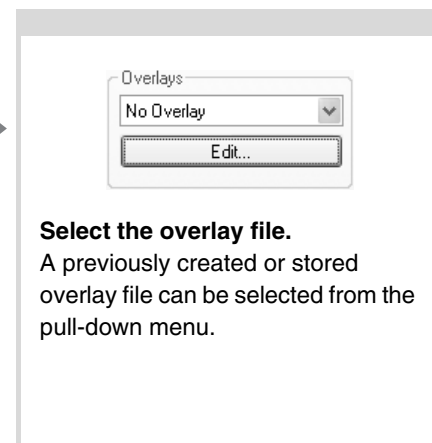

### Select the overlay file.

A previously created or stored overlay file can be selected from the pull-down menu.

# PRINT FUNCTIONS FOR SPECIAL PURPOSES

Print functions for special purposes can be found in the "Special Option" field on the [Paper] tab of the printer driver properties window.

Click the [Settings] button to display the setting screen of the selected print function.



- Select [Normal] when you do not wish to use a print function in "Special Option".
- The functions that are available vary depending on the printer driver type.

## PRINTING SPECIFIED PAGES ON DIFFERENT PAPER (Different Paper)

The front and back cover and specified pages of a document can be printed on paper that is different from the other pages. Use this function when you wish to print the front and back cover on heavy paper, or insert colored paper or a different paper type at specified pages. You can also insert paper as an insert without printing on it.

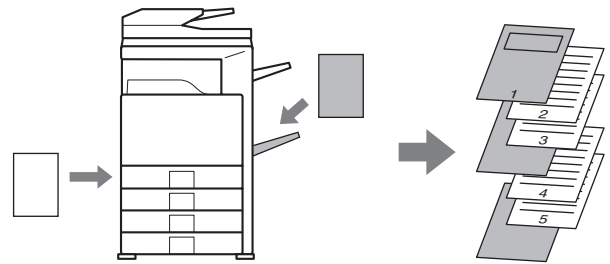

### Selecting the settings:

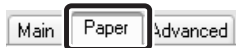

The settings are on the [Paper] tab.

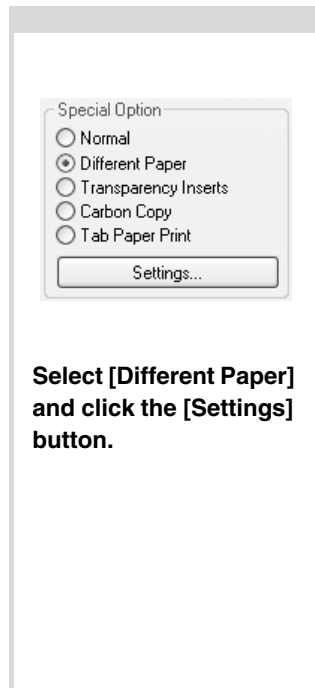

Select [Different Paper] and click the [Settings] button.

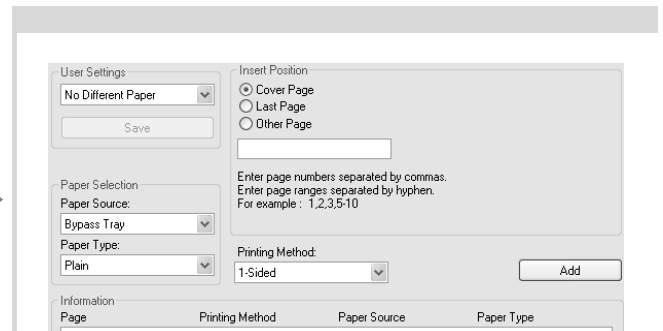

### Select insert settings

The paper setting, insertion position, and printing method can be selected. Settings configured here can be added by clicking the [Add] button. Saved settings can be checked in the "Information" list. Settings are added to this list when they are saved. When you have completed the settings, click the [Save] button.



When [Bypass Tray] is selected in "Paper Source", be sure to select the "Paper Type".



# ADDING INSERTS WHEN PRINTING ON TRANSPARENCY FILM (Transparency Inserts)

When printing on transparency film, this function helps prevent the sheets of transparency film from sticking together by inserting a sheet of paper between each sheet of film. It is also possible to print the same content on each inserted sheet of paper as is printed on the corresponding sheet of transparency film.

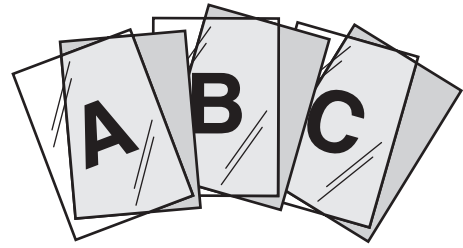

## Selecting the settings:

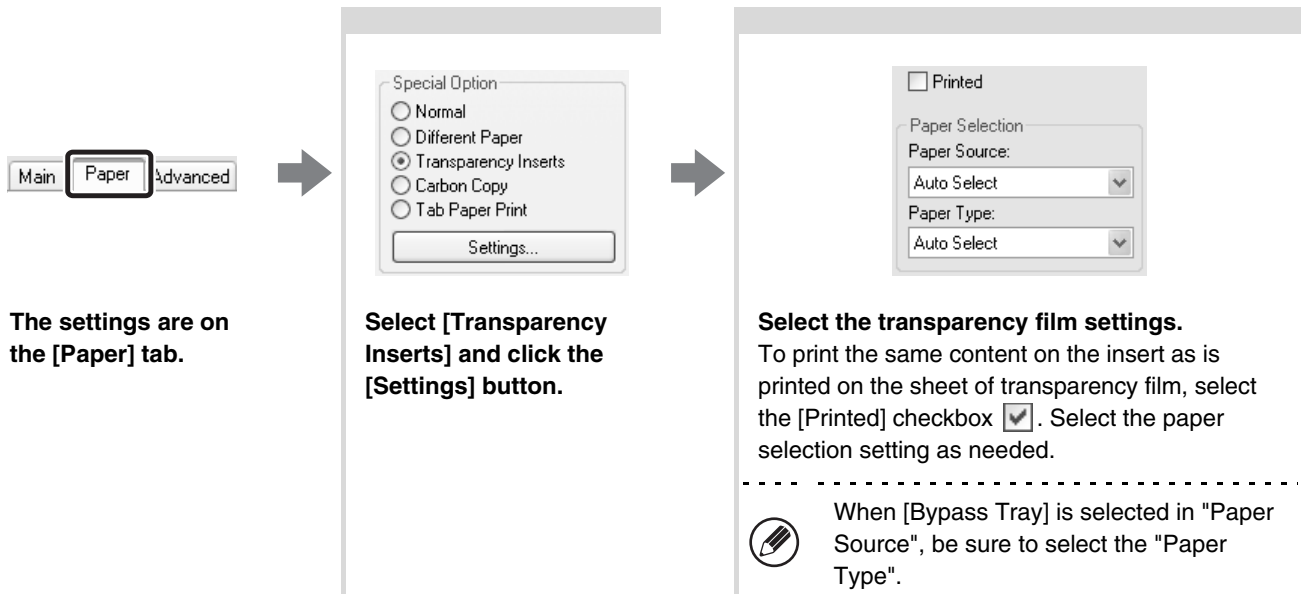

# PRINTING A CARBON COPY (Carbon Copy)

This function is used to print an additional copy of the print data on paper that is the same size but from a different paper tray.

For example, if carbon copy print is selected when standard paper is loaded in tray 1 and colored paper is loaded in tray 2, a print result similar to a carbon copy slip can be obtained by selecting the print command only once. As another example, if standard paper is loaded in tray 1 and recycled paper is loaded in tray 2, Carbon Copy can be used to simultaneously print one copy for presentation and one copy as a duplicate.

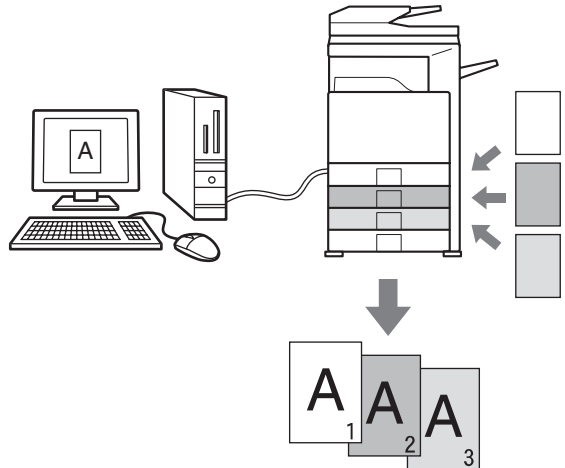

## Selecting the settings:

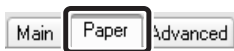

The settings are on the [Paper] tab.

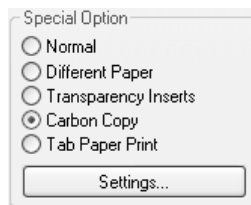

Select [Carbon Copy] and click the [Settings] button.

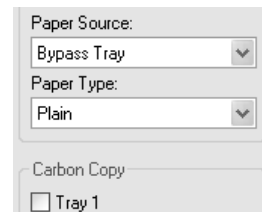

### Select the carbon copy settings.

Select the tray for the "Top Copy" and then select the tray for the carbon copy (or copies) in "Carbon Copy".



When the bypass tray is selected, be sure to select the "Paper Type".

# PRINTING TEXT ON TABS OF TAB PAPER (Tab Printing)

This function is used to print text on the tabs of tab paper.

## Printing tab data created in the printer driver (PCL6 only)

Enter the text to be printed on the tabs in [Tab Paper Print] on the [Paper] tab of the printer driver properties window, and configure detailed settings such as the size of the tabs, the starting position, the distance between tabs, and the page numbers where tab sheets will be inserted.

## Printing tab data created in a software application

After creating the text to be printed on the tabs in a software application, use [Tab Paper Settings] on the [Advanced] tab of the printer driver properties window to specify how far the text needs to be shifted for tab printing.

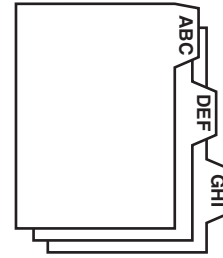

## Selecting the settings:

Printing tab data created in the printer driver (PCL6 only)

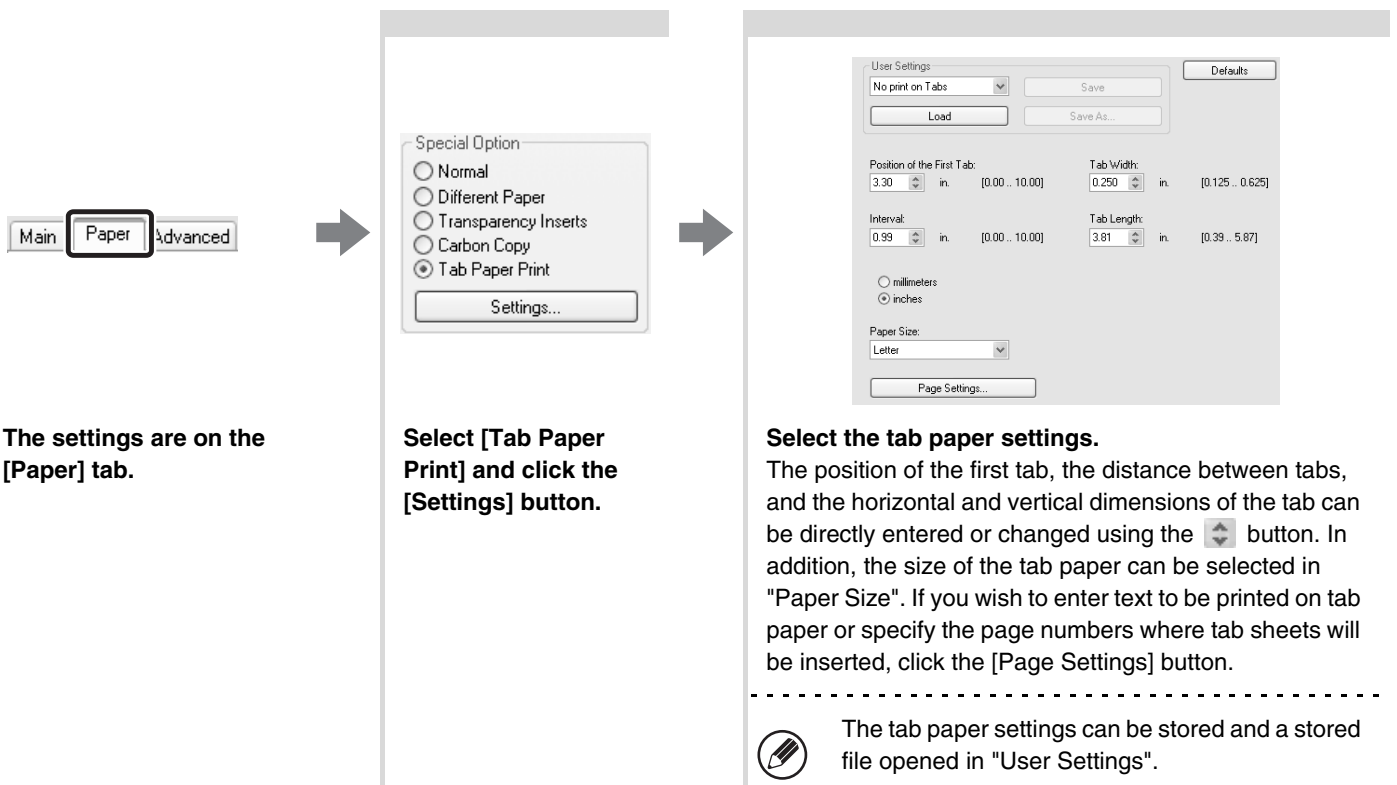

Printing tab data created in a software application

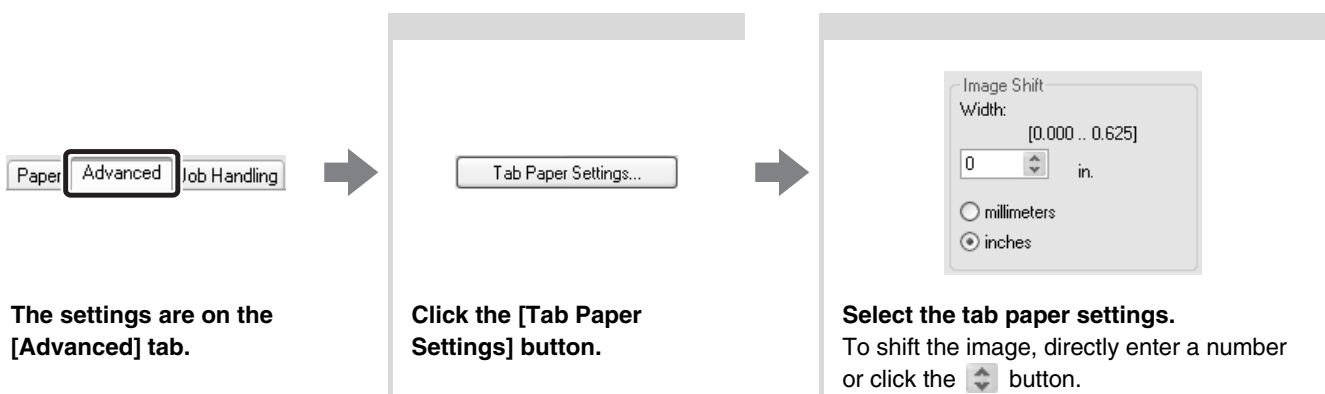

---

---

# CONVENIENT PRINTER FUNCTIONS

## USING TWO MACHINES TO PRINT A LARGE PRINT JOB (Tandem Print)

Two machines are required to use this function. Tandem Print allows you to divide a large print job between two machines connected to your network. The machines simultaneously print each half of the job, making it possible to shorten the printing time when printing a large number of sets.

To use Tandem Print, the IP address of the slave machine configured in "Tandem Connection Setting" of the machine's system settings (administrator) must be configured in the printer driver. This can be accomplished automatically by clicking the [Auto Configuration] button on the [Configuration] tab of the printer driver.

Tandem Print can only be used when the printer driver is installed using a "Standard installation" or a "Custom installation" with "LPR Direct Print" selected.

Example: Printing 4 sets of copies

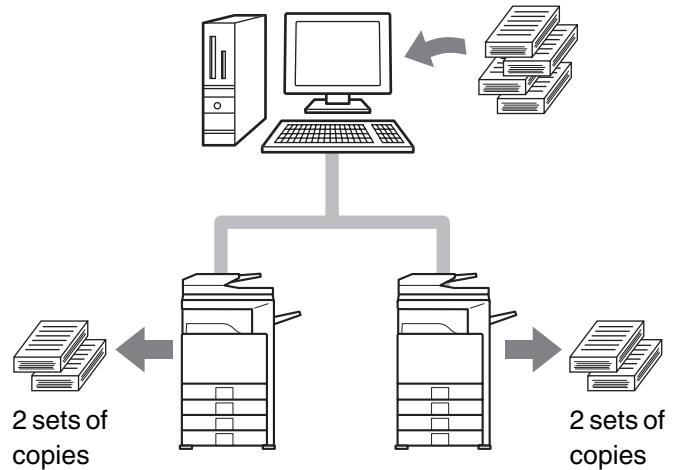

### Selecting the settings:



The setting is on the [Advanced] tab.



Tandem Print

Select the [Tandem Print] checkbox .

# USING THE DOCUMENT FILING FUNCTION (Retention/Document Filing)

This function is used to store a print job as a file on the machine's hard drive, allowing the job to be printed from the operation panel when needed. You can select a folder to keep the file from being mixed together with files of other users, and a password (from 5 to 8 digits number) can be established to prevent others from accessing the file.

To print a file stored with a password, the password must be entered on the machine.

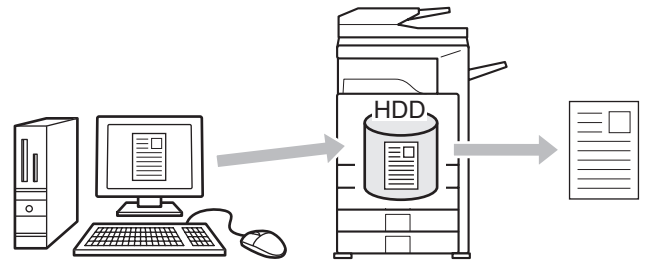

## Hold Only

This setting is used to hold a print job on the machine's hard drive without printing it.

## Hold After Print

This setting is used to hold a print job on the machine's hard drive after it is printed.

## Sample Print

When a print job is sent to the machine, only the first set of copies is printed. After checking the contents of the first set of copies, you can print the remaining sets from the operation panel of the machine. This prevents the occurrence of excessive misprints.

To print files stored on the machine's hard drive, see the Document Filing Guide.

## Selecting the settings:



The settings are on the [Job Handling] tab.

A screenshot of the 'Retention' settings screen. It features a 'Retention' checkbox which is checked. Below it is a 'Retention Settings' section containing three radio buttons: 'Hold Only' (selected), 'Hold After Print', and 'Sample Print'. At the bottom, there is a 'Password' checkbox which is checked, followed by a password input field containing six dots.

**Select the retention setting.**  
Select the [Retention] checkbox  and then select the retention method for the print job in "Retention Settings". To enter the password (from 5 to 8 digits number), click a [Password] checkbox .

A screenshot of the 'Document Filing Settings' screen. It shows three radio buttons: 'Quick File', 'Main Folder' (selected), and 'Custom Folder'. Below these is a 'Stored to...' button.

**Select document filing settings.**  
Select the folder for storing the file in "Document Filing Settings". If you selected [Custom Folder], click the [Stored to] button to select the folder.

---

- When [Quick File] is selected, "Retention Settings" will be set to [Hold After Print] only.
- When [Quick File] is selected, the password entered in "Retention Settings" is cleared and cannot be used.
- To store a file in a custom folder, the custom folder must first be created using "Document Filing Control" in the system settings (administrator). If a password has been established for a custom folder, enter the "Folder Password" in the folder selection screen.

---

---

# SAVING FREQUENTLY USED PRINT SETTINGS

Settings configured on each tab at the time of printing can be saved as user settings. Saving frequently used settings or complex color settings under an assigned name makes it easy to select those settings the next time you need to use them.

## SAVING SETTINGS AT THE TIME OF PRINTING

Settings can be saved from any tab of the printer driver properties window. Settings configured on each tab are listed at the time of saving, allowing you to check the settings as you save them.

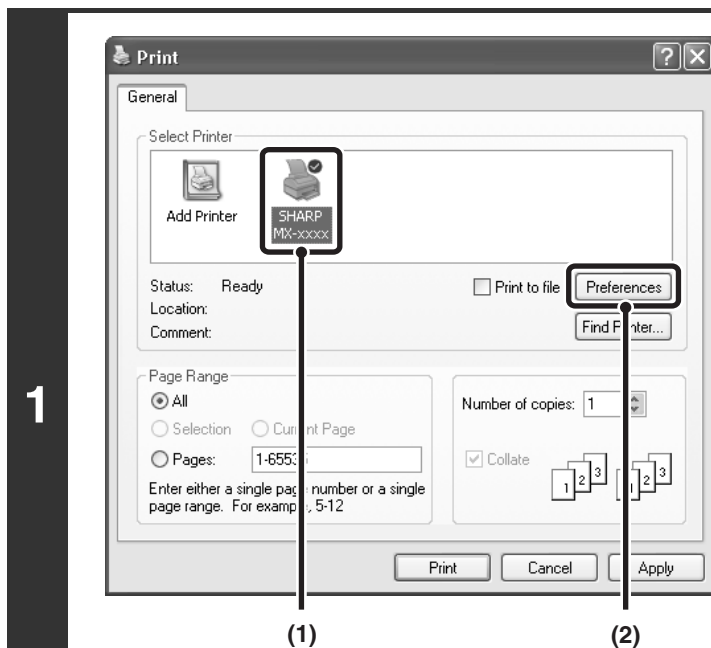

**Open the printer driver properties window from the print window of the software application.**

- (1) Select the printer driver of the machine.
- (2) Click the [Preferences] button.



The button that is used to open the printer driver properties window (usually [Properties] or [Printing Preferences]) may vary depending on the software application.

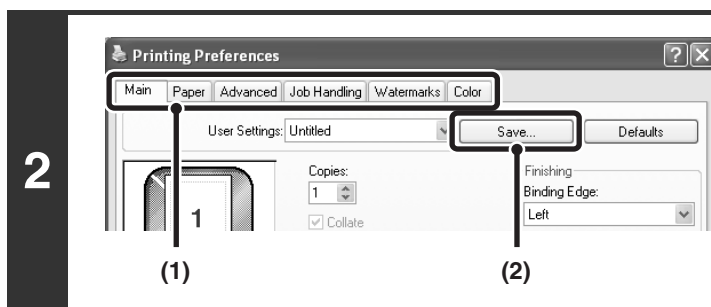

**Save the print settings.**

- (1) Configure print settings on each tab.
- (2) Click the [Save] button.

3

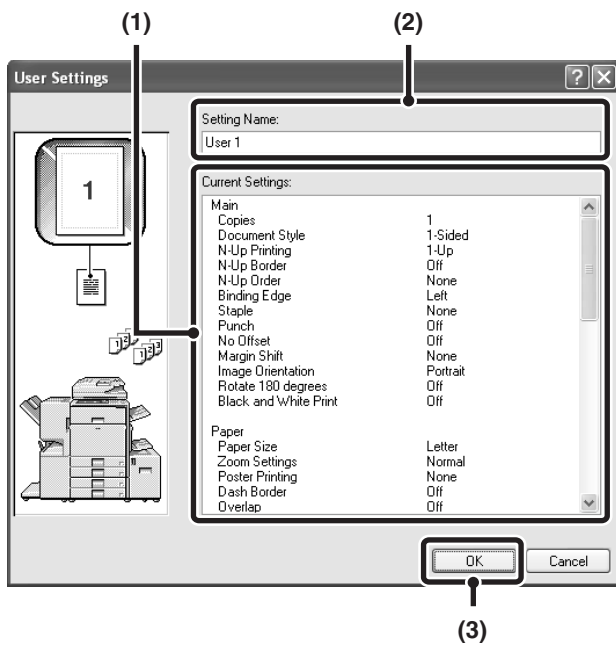

**Check and save the settings.**

- (1) Check the displayed settings.
- (2) Enter a name for the settings (maximum of 20 characters).
- (3) Click the [OK] button.

4

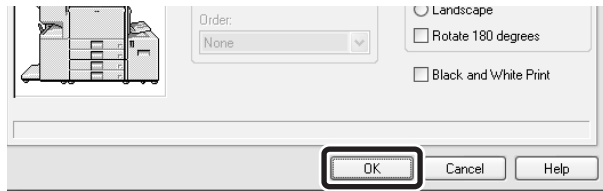

**Click the [OK] button.**

5

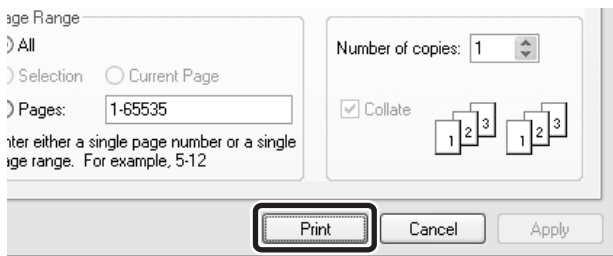

**Start printing.**



- Up to 30 sets of user settings can be saved.
- The following items cannot be saved in user settings.
  - A watermark that you created
  - Paper insertion settings
  - Overlay file
  - [Tab Paper Print] settings on the [Paper] tab (PCL6 only)
  - The login name, password, user name, and job name entered in the [Job Handling] tab

# USING SAVED SETTINGS

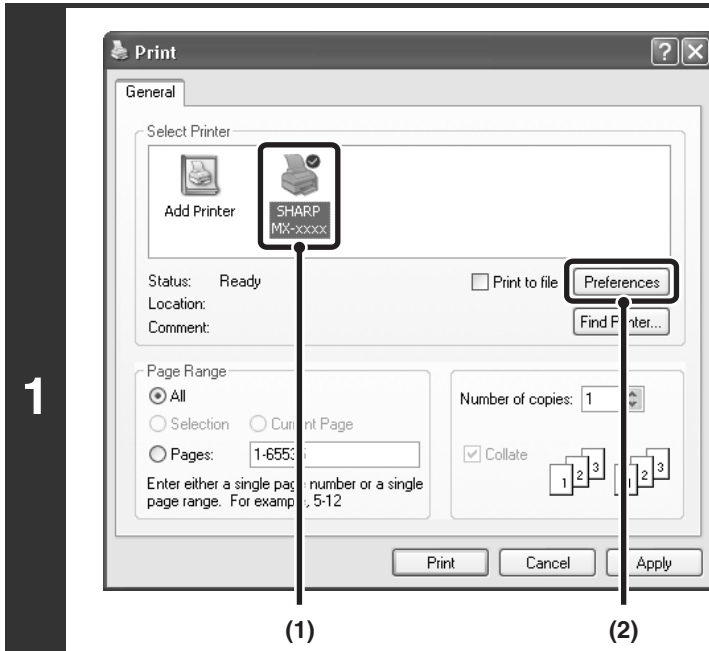

Open the printer driver properties window from the print window of the software application.

- (1) Select the printer driver of the machine.
- (2) Click the [Preferences] button.



The button that is used to open the printer driver properties window (usually [Properties] or [Printing Preferences]) may vary depending on the software application.

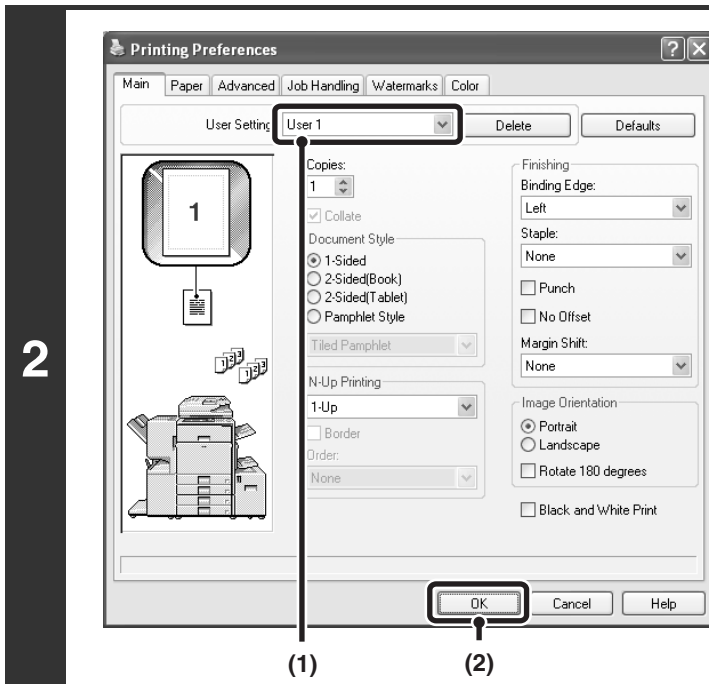

Select the print settings.

- (1) Select the user settings that you wish to use.
- (2) Click the [OK] button.

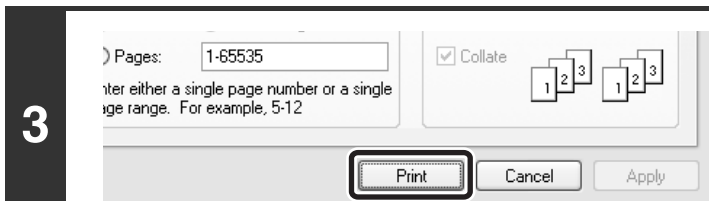

Start printing.

## Deleting saved settings

Select the user settings that you want to delete in the step 2 above, and click the [Delete] button.



---

---

# CHANGING THE PRINTER DRIVER DEFAULT SETTINGS

The default settings of the printer driver can be changed using the procedure below. The settings selected using this procedure are saved and become the default settings when printing from a software application. (Settings selected in the printer driver properties window when printing from an application remain in effect only while the application is in use.)

1

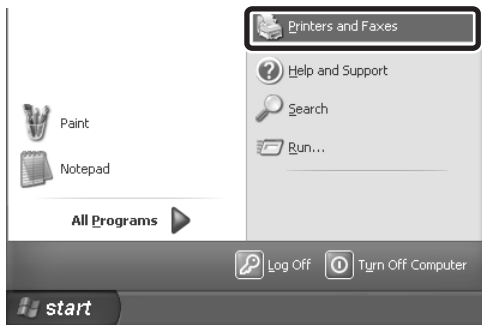

**Click the [start] button and then click [Printers and Faxes].**

In Windows 98/Me/NT 4.0/2000, click the [Start] button, point to [Settings], and then select [Printers].



In Windows XP, if [Printers and Faxes] does not appear in the [start] menu, select [Control Panel], select [Printers and Other Hardware], and then select [Printers and Faxes].

2

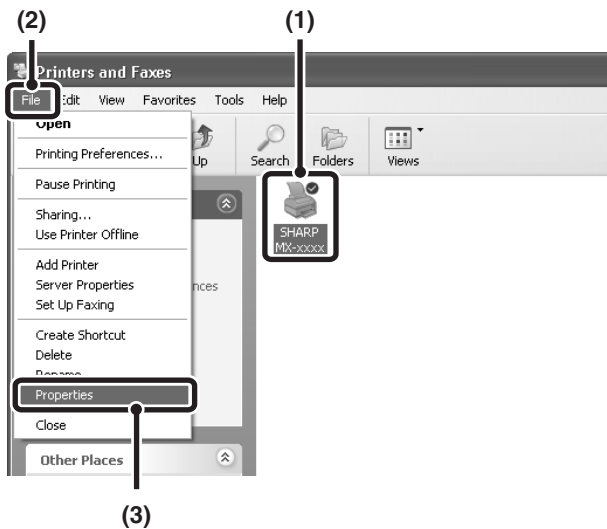

**Open the printer properties window.**

**(1) Click the icon of the printer driver of the machine.**

**(2) Click the [File] menu.**

**(3) Select [Properties].**

In Windows NT 4.0, select [Document Defaults] from the [File] menu to open the printer driver properties window. Go to step 4.

3

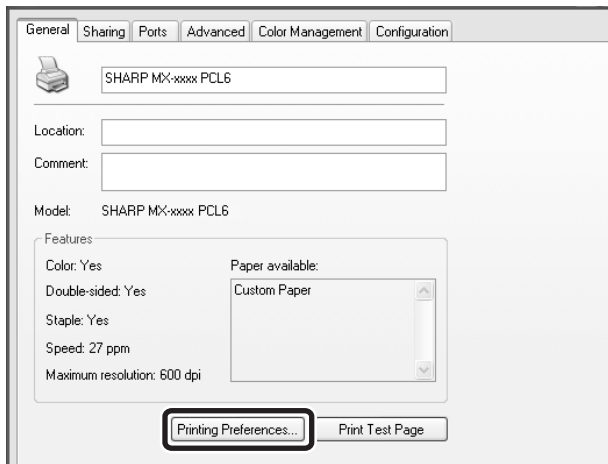

Click the [Printing Preferences] button on the [General] tab.

In Windows 98/Me, click the [Setup] tab.

4

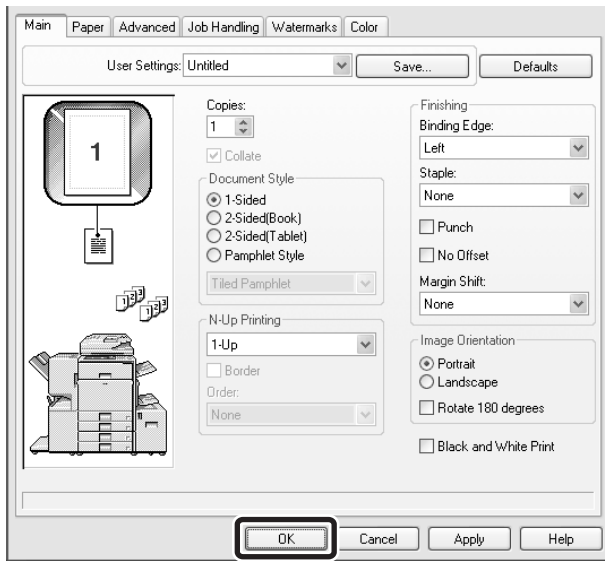

Configure the settings and click the [OK] button.

For explanations of the settings, see printer driver Help.

# 3

# PRINTING FROM A MACINTOSH

## BASIC PRINTING PROCEDURE

The following example explains how to print a document from "TextEdit", which is a standard accessory program in Mac OS X.



To use the machine as a printer for the Macintosh, the PS3 expansion kit must be installed and the machine must be connected to a network. To install the PPD file and configure the printer driver settings, see the Software Setup Guide.

## SELECT PAPER SETTINGS

Select paper settings in the printer driver before selecting the print command.

1



Select [Page Setup] from the [File] menu of TextEdit.

2

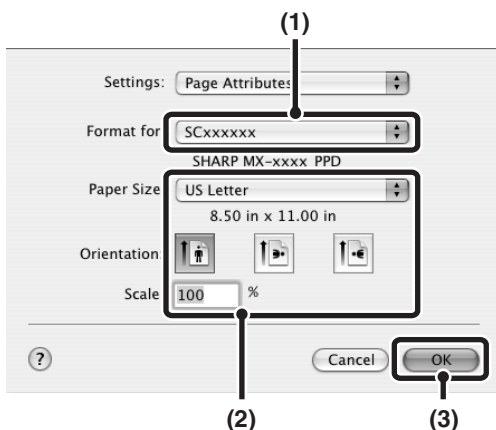

Select paper settings.

(1) Make sure that the correct printer is selected.

(2) Select paper settings.

The paper size, paper orientation, and enlarge/reduce can be selected.

(3) Click the [OK] button.



- The machine name that appears in the "Format for" menu is normally [SCxxxxxx]. ("xxxxxx" is a sequence of characters that varies depending on your machine model.)
- The contents of the screen and procedures for changing the settings vary depending on your operating system version, the printer driver version, and the software application.

# PRINT

1



Select [Print] from the [File] menu of TextEdit.

2

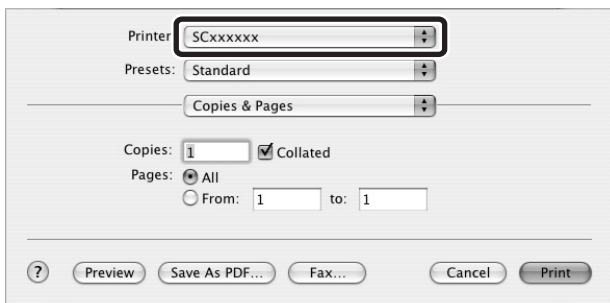

Make sure that the correct printer is selected.



- The machine name that appears in the "Printer" menu is normally [SCxxxxxx]. ("xxxxxx" is a sequence of characters that varies depending on the machine model.)
- The print window varies depending on the operating system version, the printer driver version, and the application.

3

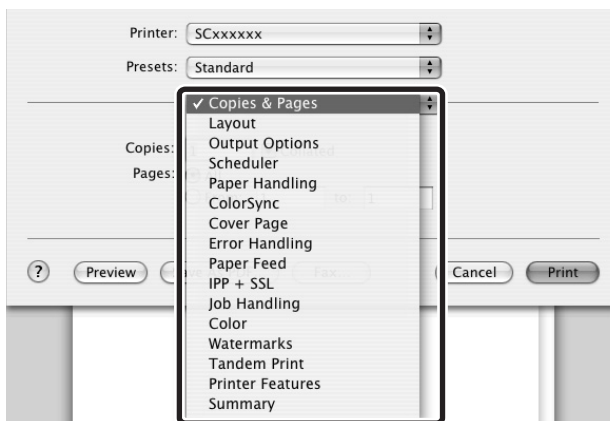

Select print settings.

Click [v] next to [Copies & Pages] ([General] in Mac OS 9.0 to 9.2.2) and select the settings that you wish to configure from the pull-down menu. The setting screen of each selected setting will appear.



- The settings vary depending on the operating system version, the printer driver version, and the application.

Printer: SCxxxxxx  
Presets: Standard  
Copies & Pages  
Copies: 1  Collated  
Pages:  All  
 From: 1 to: 1  
Buttons: ? Preview Save As PDF... Fax... Cancel **Print**

**Click the [Print] button.**

Printing begins.



The print job is delivered to the output tray, with the position of the paper offset slightly from the previous job (other than the right tray).

# SELECTING THE PAPER

This section explains the [Paper Feed] settings ([Paper Source] setting in "General" in Mac OS 9.0 to 9.2.2) in the print settings window.

- **When [Auto Select] is selected**

A tray with plain paper or recycled paper (the factory default setting is plain paper only) of the size specified in "Paper Size" in the page settings window is automatically selected.

- **When a paper tray is selected**

The specified tray is used for printing regardless of the "Paper Size" setting in the page settings window. A paper type can also be specified for the bypass tray. Check the bypass tray and make sure that the desired type of paper is loaded, and then select the appropriate paper type setting for the bypass tray.



- Special media such as postcards or envelopes can also be placed in the bypass tray. For the procedure for loading paper and other media in the bypass tray, see "LOADING PAPER IN THE BYPASS TRAY" in the User's Guide.
- When "Enable Detected Paper Size in Bypass Tray" (disabled by factory default) or "Enable Selected Paper Type in Bypass Tray" (enabled by factory default) is enabled in the system settings (administrator), printing will not take place if the paper size or paper type specified in the printer driver is different from the paper size or paper type specified in the settings of the bypass tray.

- **When a paper type is selected**

A tray with the specified type of paper and the size specified in "Paper Size" in the page settings window is used for printing.



**System Settings (Administrator): Exclude Bypass-Tray from Auto Paper Select**

When [Auto Select] is selected, specify whether or not the paper in the bypass tray will be excluded from the paper that can be automatically selected. This setting is disabled by factory default, and thus paper in the bypass tray is included in the paper that can be automatically selected. If special types of paper are frequently loaded in the bypass tray, it is recommended that this setting be enabled.

---

---

# PRINTING WHEN THE USER AUTHENTICATION FUNCTION IS ENABLED

When the user authentication function is enabled in the machine's system settings (administrator), your user information (login name, password, etc.) must be entered when you print. The information that must be entered varies depending on the authentication method being used, so check with the administrator of the machine before printing.

1

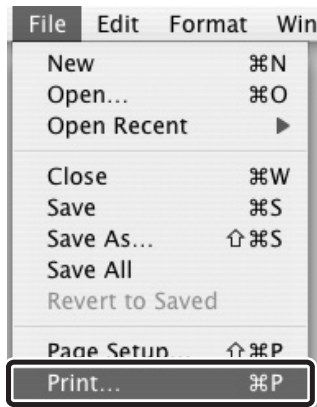

Select [Print] from the application's [File] menu.



The menu used to execute printing may vary depending on the software application.

2

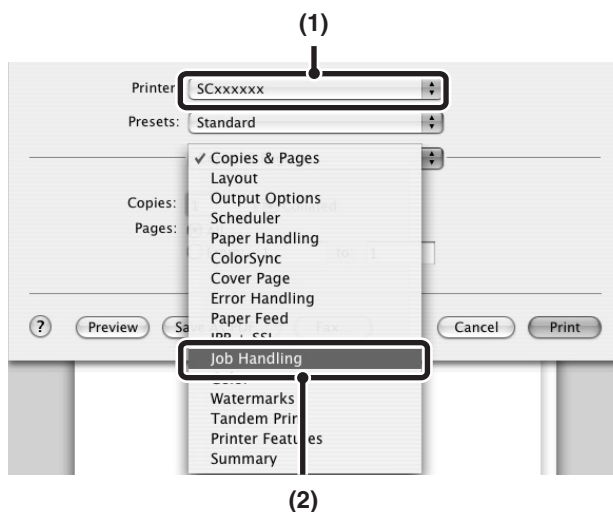

Display the job handling screen.

(1) Make sure that the machine's printer name is selected.

(2) Select [Job Handling].

In Mac OS 9.0 to 9.2.2, select [User Authentication].



- The machine name that appears in the "Printer" menu is normally [SCxxxxxx]. ("xxxxxx" is a sequence of characters that varies depending on the machine model.)
- The print window varies depending on the operating system version, the printer driver version, and the application.

Printer: SCxxxxxx  
Presets: Standard  
Job Handling

Retention

Retention Settings

Hold Only  
 Hold After Print  
 Sample Print

Password:

Document Filing Settings

Quick File  
 Main Folder  
 Custom Folder

Stored to...

Job ID

User Name:    
Job Name:

(2)

(1)

## Start printing.

### (1) Enter your user information.

- **When authentication is by login name/password**  
Enter your login name in "Login Name" and your password in "Password" (1 to 32 characters).
- **When authentication is by user number**  
Enter your user number (5 to 8 digits) in "User Number".

### (2) Click the [Print] button.



You can click the (lock) button after entering your login name and password, or user number, to simplify operation the next time you wish to print based on the same user authentication.



- Normally printing is possible without entering your user information. (In this case, the printed pages will be added to the "Others" count.) When printing by invalid users is prohibited in the system settings (administrator), printing is not permitted when user information is not entered or incorrect information is entered.
- If you are using Mac OS X v10.1.5, the user authentication function of the machine is not available. For this reason, printing will not be possible if printing by invalid users is prohibited in the system settings (administrator).



#### System Settings (Administrator): Disable Printing by Invalid User

This is used to prohibit printing of print jobs by users whose user information is not stored in the machine. When this function is enabled, printing is not allowed when user information is not entered or incorrect information is entered.



# 4

## PRINTING WITHOUT THE PRINTER DRIVER

When you do not have the printer driver installed on your computer, or when the software application used to open a file that you wish to print is not available, you can print directly to the machine without using the printer driver. The file types (and corresponding extensions) that can be printed directly are shown below.

File Type	TIFF	JPEG	PCL	PDF/ Encrypted PDF	PS
Extension	tiff, tif	jpeg, jpg, jpe, jif	pcl	pdf	ps



- To print PDF and PS files, the PS3 expansion kit must be installed.
- Depending on the file type, it may not be possible to print some files in the above table.

---

---

## DIRECTLY PRINTING FROM THE MACHINE

A file on an FTP server or in a USB memory device connected to the machine can be selected and printed from the operation panel of the machine without using the printer driver.

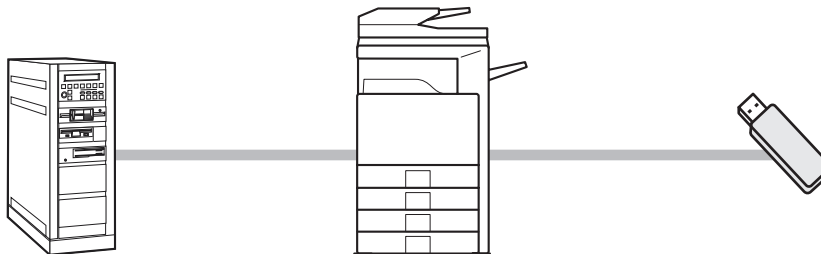

## DIRECTLY PRINTING A FILE ON AN FTP SERVER

When an FTP server is configured in the machine's Web page, you can specify and print a file on the FTP server from the operation panel of the machine. This saves you the trouble of downloading the file and printing it from a computer.



- To configure FTP server settings, click [Application Settings] and then [FTP Print Settings] in the Web page menu, and configure the settings in "FTP Print Settings from Operation Panel". (Administrator rights are required.)

1

DOCUMENT  
FILING



Press the [DOCUMENT FILING] key.

2

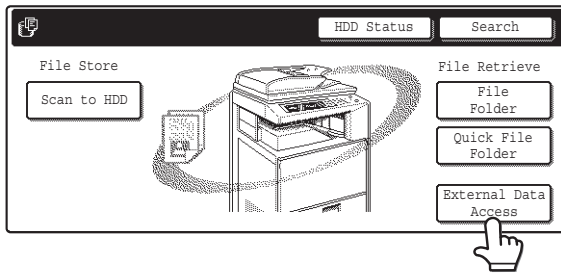

## Touch the [External Data Access] key.

The [External Data Access] key cannot be touched if an FTP server is not configured.

3

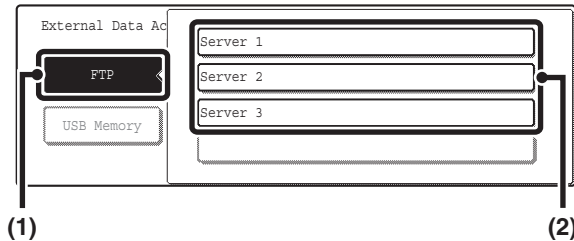

(1)

(2)



## Access the FTP server.

- (1) Touch the [FTP] key.
- (2) Touch the key of the FTP server that you wish to access.

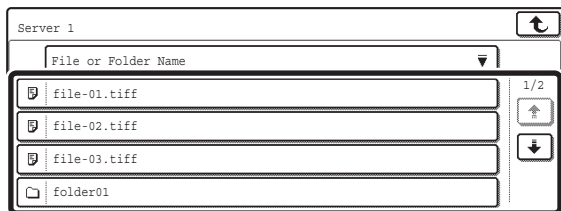

4



## Touch the key of the file that you wish to print.

- The icon  appears on the left side of keys of files that can be printed.
- The icon  is displayed on the left side of keys of folders on the FTP server. To display the files and folders in a folder, touch the key of the folder.



- A total of 100 keys of files and folders can be displayed.
- Touch the  key to move up one folder level.
- When you move down a folder level by touching a folder key, the  key appears in the top right corner of the screen. Touch this key to move up to the root folder (the top folder level in the selected FTP server).
- Touch the [File or Folder Name] key (or the [File Name] key) to change the order of the files and folders displayed on the screen. The order switches between ascending order and descending order each time you touch the key.

5

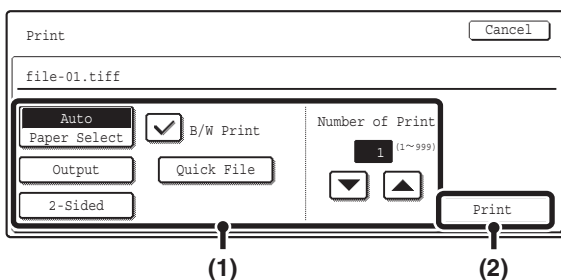

(1)

(2)

## Print the selected file.

### (1) Select print conditions.

If you selected a file (PCL or PS) in step 4 that includes print settings, the settings will be applied.

### (2) Touch the [Print] key.

Printing begins. When the message "Job stored. ..." appears in the touch panel, touch the [OK] key.



When you select a PDF file that has a password, you must enter the password in the job status screen to begin printing.

 [PRINTING AN ENCRYPTED PDF FILE](#) (page 54)

# DIRECTLY PRINTING A FILE IN USB MEMORY

A file in a USB memory device connected to the machine can be printed from the operation panel of the machine without using the printer driver. When the printer driver of the machine is not installed on your computer, you can copy a file into a commercially available USB memory device and connect the device to the machine to print the file directly.

1

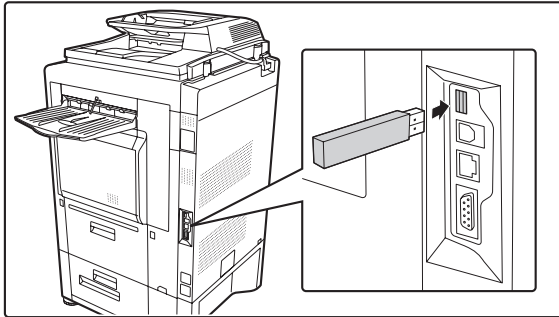

**Connect the USB memory device to the machine.**



- If a USB hub is connected to the machine, connect the USB memory device to the USB hub.
- If another USB memory device is connected to the hub, the file will not appear correctly. Remove all USB memory devices from the USB hub before connecting your USB memory device.
- Consult your dealer for USB memory devices that can be used.

2



**Press the [DOCUMENT FILING] key.**

3

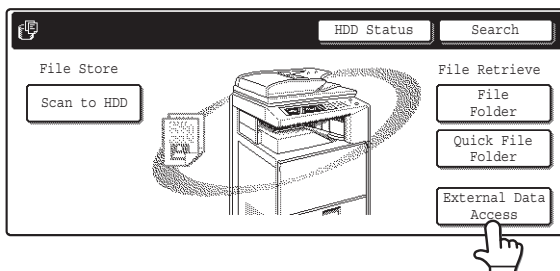

**Touch the [External Data Access] key.**

If the USB memory device is not connected correctly, the [External Data Access] key cannot be touched.

4

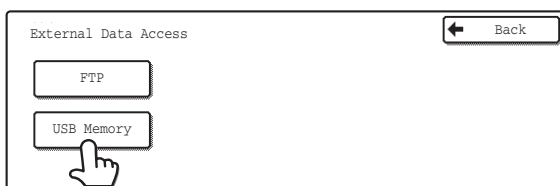

**Touch the [USB Memory] key.**

5



## Touch the key of the file that you wish to print.

A maximum of 100 printable files in the USB memory device can be displayed.



- To return to the screen of step 4, touch the [Back] key.
- Files in a folder in a USB memory device will not appear.
- To change the order of display of the files on the screen, touch the [File Name] key. The order switches between ascending order and descending order each time you touch the key.

6

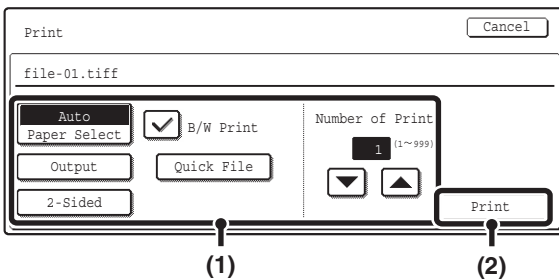

## Print the selected file.

### (1) Select print conditions.

If you selected a file (PCL or PS) in step 5 that includes print settings, the settings will be applied.

### (2) Touch the [Print] key.

Printing begins after the selected file is transferred. When the message "Job stored. ..." appears in the touch panel, touch the [OK] key.



### To cancel printing...

To cancel printing while the file is being transferred, touch the [Cancel] key in the message screen that appears in the touch panel.

7

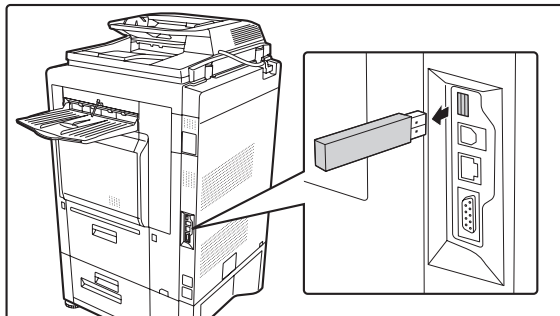

## Remove the USB memory device from the machine.



When you select a PDF file that has a password, you must enter the password in the job status screen to begin printing.

[PRINTING AN ENCRYPTED PDF FILE](#) (page 54)

---

---

# DIRECTLY PRINTING FROM A COMPUTER

Settings can be configured in the Web pages of the machine to enable direct printing from a computer without using the printer driver.

## SUBMIT PRINT JOB

You can specify a file to be printed directly without using the printer driver.

In addition to a file on your computer, this procedure can be used to print any file that can be accessed from your computer, such as a file on another computer connected to the same network.

To directly print a file on a computer, click [Document Operations] and then [Submit Print Job] in the Web page menu.

## FTP PRINT

You can print a file from your computer by simply dragging and dropping the file onto the FTP server of the machine.

- **Configuring settings**

To enable FTP Print, click [Application Settings] and then [FTP Print Settings] in the Web page menu, enable FTP Print in "FTP Print Settings from Client PC", and configure the port number. (Administrator rights are required.)

- **Performing FTP Print**

Type "ftp://" and then the IP address of the machine in the address bar of your computer's Web browser as shown below.

**(Example)**

ftp://192.168.1.28

Drag and drop the file that you wish to print onto the "Ip" folder that appears in your Web browser. The file will automatically begin printing.



If you printed a file (PCL or PS) that includes print settings, the settings will be applied.

# E-MAIL PRINT

An e-mail account can be configured in the machine to have the machine periodically check your mail server and automatically print received e-mail attachments without using the printer driver.

## • Configuring settings

To use E-mail Print, you must first configure an e-mail account in the machine. To configure an account, click [Application Settings] and then [E-mail Print Settings] in the Web page menu. (Administrator rights are required.)

## • Using E-mail Print

To print a file using E-mail Print, use your e-mail program on your computer to send the file as an attachment to the machine's e-mail address.

Control commands can be entered in the message of the e-mail to specify the number of copies and print format. Commands are entered in the format "command name = value".

The following control commands can be entered:

Function	Command name	Values
Copies	COPIES	1-999
Staple	JOBSTAPLE	STAPLENO, STAPLELEFT, STAPLETWO
Punch	PUNCH	OFF, ON
Output	COLLATE	OFF, ON
Two-sided print	DUPLEX	OFF, TOP, LEFT, RIGHT
Account number*	ACCOUNTNUMBER	Number (5 to 8 digits)
File type	LANGUAGE	PCL, PCLXL, POSTSCRIPT, PDF, TIFF, JPG
Paper	PAPER	Name of available paper (LETTER, A4, etc.)
Document Filing	FILE	OFF, ON
	FOLDERNAME	30 characters
Quick File	QUICKFILE	OFF, ON
Output tray	OUTTRAY	CENTER, RIGHT, FINISHER
Black and white printing	B/W PRINT	OFF, ON

## Example

```
COPIES=2
DUPLEX=LEFT
ACCOUNTNUMBER=11111
PAPER=LETTER
B/W PRINT=ON
```

\* Can be omitted except when authentication is by user number.



- Enter the commands in Plain Text format. If entered in Rich Text format (HTML), the commands will have no effect.
- To receive a list of the control commands, enter the command "Config" in the e-mail message.
- If nothing is entered in the body text (message) of the e-mail, printing will take place according to the "Printer Default Settings" in the system settings. If you printed a file (PCL or PS) that includes print settings, the settings will be applied.
- To print PDF and PS files, the PS3 expansion kit must be installed.
- Only enter a "File type" when you are specifying a page-description language. Normally there is no need to enter a file type.

# PRINTING AN ENCRYPTED PDF FILE

Encrypted PDF is used to protect a PDF file by requiring the entry of a password to print or edit the file. To directly print an encrypted PDF file on an FTP server or in a USB memory device, follow the steps below to enter the password and begin printing.



The PS3 expansion kit is required to use this function.

1

## JOB STATUS

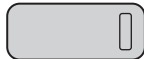

Press the [JOB STATUS] key.

2

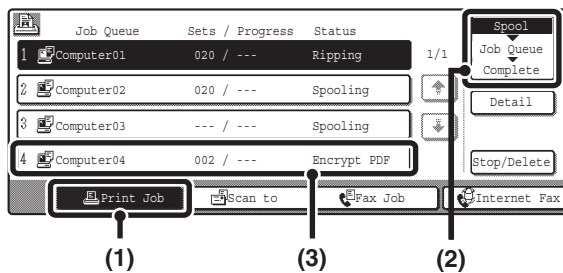

Select the encrypted PDF print job.

- (1) Touch the [Print Job] key.
- (2) Change the print job status mode to [Spool].

The mode changes each time the key is touched. The currently selected mode is highlighted.

- (3) Touch the print job key of the PDF file that has the password.

3

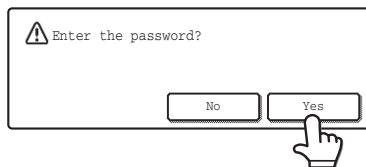

Touch the [Yes] key.

A text entry screen will appear. Enter the password (maximum of 32 characters) and touch the [OK] key. The print job will move to the [Job Queue].



When both a master password and a user password (which is used to open the file) have been set, enter the master password.



- To print an encrypted PDF file using the printer driver, enter the password when opening the file on your computer.
- Printing is not possible if you do not know the password for an encrypted PDF file. To delete a spooled print job, touch the [No] key in the screen of step 3 and touch the [Stop/Delete] key.
- Encrypted PDF versions that can be directly printed are 1.5 (Adobe® Acrobat® 6.0) and earlier.

# 5

## CHANGING THE JOB QUEUE

### GIVING A PRINT JOB PRIORITY / CANCELING A PRINT JOB

#### GIVING A PRINT JOB PRIORITY

When the machine is busy copying or printing a received fax or other job, you can give priority to a print job that is waiting to be printed and print it ahead of the other jobs.

1

JOB STATUS



Press the [JOB STATUS] key.

2

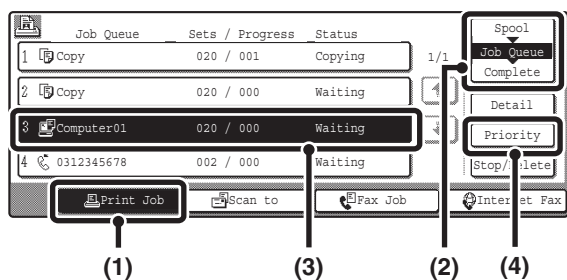

Give the desired job priority.

- (1) Touch the [Print Job] key.
- (2) Change the print job status mode to [Job Queue].

Touch this key to change modes. The selected mode will be highlighted.

- (3) Touch the key of the print job to which you want to give priority.
- (4) Touch the [Priority] key.

The job being printed stops and the job selected in (3) is printed.



To check print information on the selected job, touch the [Detail] key.



# CANCELING A PRINT JOB

A job being printed, a job waiting to be printed, or a spooled job can be canceled.

1

JOB STATUS



Press the [JOB STATUS] key.

2

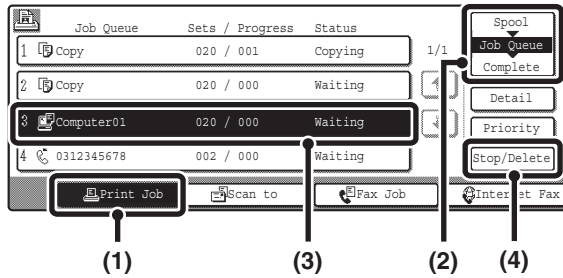

Cancel the job.

- (1) Touch the [Print Job] key.
- (2) Change the print job status mode to [Spool] or [Job Queue].  
Touch this key to change modes. The selected mode is highlighted.
- (3) Touch the key of the print job that you wish to cancel.
- (4) Touch the [Stop/Delete] key.
- (5) A message appears to confirm the cancellation. Touch the [Yes] key.  
The selected job key is deleted and printing is canceled.



It is also possible to cancel printing with the [STOP] key (⏹) on the operation panel. When the [STOP] key (⏹) is pressed, a message will appear asking you if you want to cancel the job.



**If you do not want to cancel the selected print job...**  
Touch the [No] key in step 5.

# CHANGING TO ANOTHER PAPER SIZE AND PRINTING WHEN PAPER RUNS OUT

If printing stops because the machine ran out of paper, or if the size of paper specified in the printer driver is not loaded in the machine, a message will appear in the touch panel. Printing will begin automatically when the [OK] key is touched and paper is loaded in the machine. If you wish to print on paper in another tray because the desired size of paper is not immediately available, follow the steps below.

1

JOB STATUS



Press the [JOB STATUS] key.

2

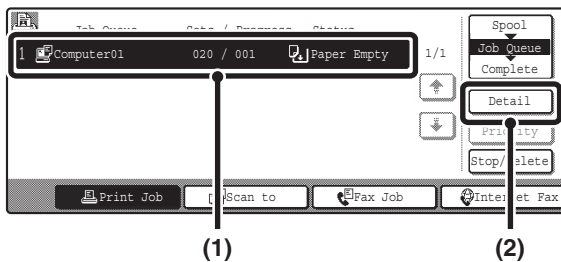

Display details on the print job for which there is no paper.

- (1) Touch the key of the job for which "Paper Empty" appeared.
- (2) Touch the [Detail] key.

3

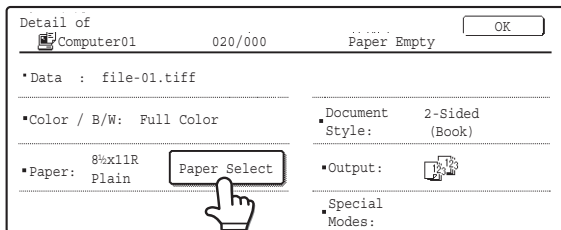

Touch the [Paper Select] key.

4

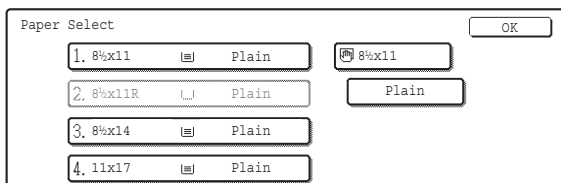

Touch the key of the tray that has the paper you wish to use.

Printing begins.



If you change to another paper size before printing, printing may not take place correctly; for example part of the text or image may run off the paper.

# 6

# PRINTER DRIVER SPECIFICATIONS

## PRINTER DRIVER SPECIFICATION LIST

Driver selections		PCL6	PCL5c	PS	Windows PPD*1	Macintosh PPD*1	
Frequently used functions	Copies	1-999	1-999	1-999	1-999	1-999	
	Orientation	Yes	Yes	Yes	Yes	Yes	
	N-Up	Printing	2,4,6,8,9,16	2,4,6,8,9,16	2,4,6,8,9,16	2,4,6,9,16*2,3	2,4,6,9,16
		Order	Selectable	Selectable	Selectable	Selectable	Selectable
		Border	On/Off	On/Off	On/Off	Yes	Selectable
	Duplex	Yes	Yes	Yes	Yes	Yes	
	Fit To Page	Yes	Yes	Yes	No	Yes*4	
	Binding Edge	Selectable	Selectable	Selectable	No	Yes*5	
	Black and White Print	Yes	Yes	Yes	Yes	Yes	
	Staple*6	Yes	Yes	Yes	Yes	Yes	
Punch*6	Yes	Yes	Yes	Yes	Yes		
Paper	Paper Size	Yes	Yes	Yes	Yes	Yes	
	Custom Paper	1 size	1 size	1 size	Yes*2	Yes*5	
	Paper Selection	Yes	Yes	Yes	Yes	Yes	
	Output	Yes	Yes	Yes	Yes	Yes	
Convenient printer functions	Pamphlet/Pamphlet Staple*7	Yes	Yes	Yes	Yes	Yes	
	Margin Shift	10mm/20mm/30mm	10mm/20mm/30mm	10mm/20mm/30mm	Yes	Yes	
	Poster Printing	Yes	No	Yes	No	No	
	Rotate 180 degrees	Yes	Yes	Yes	Yes	Yes*5	
	Zoom/XY-Zoom	Yes*8	Yes*8	Yes	Yes*8	Yes*8	
	Mirror Image	No	No	Yes	Yes	Yes*9	

Driver selections		PCL6	PCL5c	PS	Windows PPD*1	Macintosh PPD*1
Special functions	Different Paper	Yes	Yes	Yes	No	Yes*10
	Transparency Inserts	Yes	Yes	Yes	Yes	Yes
	Carbon Copy	Yes	Yes	Yes	No	No
	Tab Printing	Yes	Yes	Yes	No	No
	Tandem Print	Yes	Yes	Yes	No	Yes*5,11
	Retention	Yes	Yes	Yes	No	Yes*5
	Document Filing	Yes	Yes	Yes	No	Yes*5,11
Color mode adjusting function	Color Adjustment	Yes	Yes	Yes	No	Yes*5,11,12
	Text To Black/ Vector To Black	Yes	Yes	Yes	No	No
	Image Type	Yes	Yes	Yes	Yes	Yes
Functions to combine text and images	Watermark	Yes	Yes	Yes	Yes	Yes
	Image Stamp	Yes	No	Yes	No	No
	Overlay	Yes	Yes	Yes	No	No
Graphic	Resolution	600x600 dpi/ 300x300 dpi	600x600 dpi/ 300x300 dpi	600x600 dpi/ 1200x600 dpi *13	600x600 dpi	600x600 dpi
	Graphics Mode	Yes	Yes	No	No	No
	Toner Save*14	Yes	Yes	Yes	Yes	Yes
Font	Resident font	80 fonts	80 fonts	136 fonts	136 fonts*15	35 fonts
	Download font	bitmap, TrueType, Graphics	bitmap, TrueType, Graphics	bitmap, TrueType, Type1	bitmap, TrueType, Type1	No*16
Others	Auto Configuration	Yes	Yes	Yes	No	Yes*5,12
	User Authentication	Yes	Yes	Yes	No	Yes*5

- \*1 The specifications of each function in Windows PPD and Macintosh PPD vary depending on the operating system version and the software application.
- \*2 Cannot be used in Windows NT 4.0.
- \*3 Only 2-Up and 4-Up printing can be used in Windows 98.
- \*4 Only Mac OS X v10.4 can be used.
- \*5 Cannot be used in Mac OS X v10.1.5.
- \*6 Can be used when a finisher or saddle stitch finisher is installed. (To use the punch function, a punch module must be also installed.)
- \*7 To use the pamphlet staple function, a saddle stitch finisher is required.
- \*8 The horizontal and vertical proportion cannot be set separately.
- \*9 Only Mac OS 9.0 to 9.2.2 can be used.
- \*10 Only covers can be inserted.
- \*11 Cannot be used in Mac OS 9.0 to 9.2.2.
- \*12 Cannot be used in Mac OS X v10.2.8.
- \*13 1200x600 dpi can only be selected for black and white printing.
- \*14 This setting may not operate in some software applications and operating systems.
- \*15 The number of available resident fonts is 35 in Windows NT 4.0.
- \*16 True Type and Type 1 can be selected in some versions of LaserWriter.

**SHARP**®

MODEL: MX-2300N  
MX-2700N

# Scanner Guide

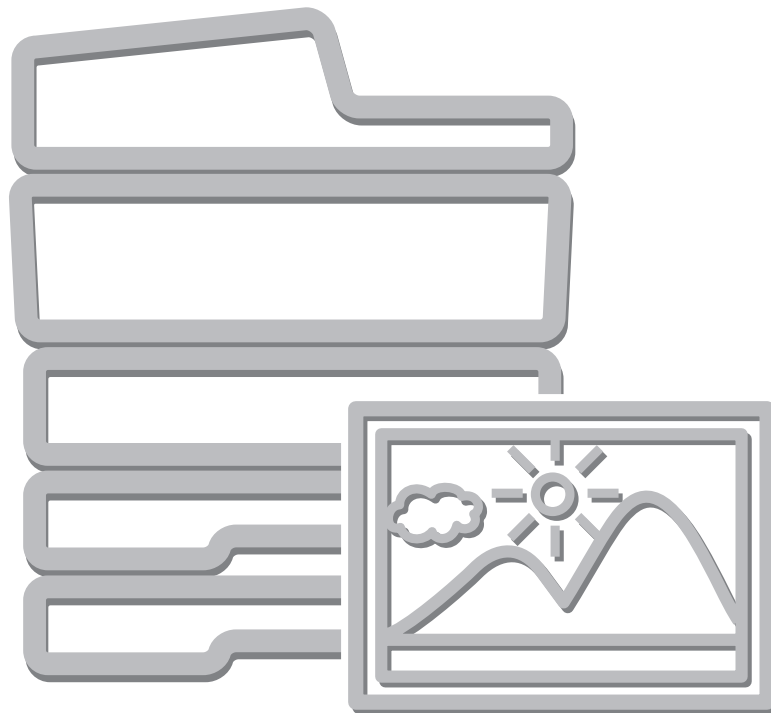

---

---

# TABLE OF CONTENTS

ABOUT THIS MANUAL .....	3
• MANUALS PROVIDED WITH THE MACHINE ...	4

## 1 BEFORE USING THE MACHINE AS A NETWORK SCANNER

NETWORK SCANNER FUNCTION .....	5
PREPARATIONS FOR USE AS A NETWORK SCANNER .....	6
• MAKE SURE THE MAIN POWER SWITCH IS IN THE "ON" POSITION .....	6
• CHECKING THE DATE AND TIME .....	6
• STORING SENDER INFORMATION .....	7
• SETTINGS REQUIRED IN THE WEB PAGE .....	7
• STORING DESTINATION ADDRESSES FOR EACH SCAN MODE IN THE ADDRESS BOOK .....	8
• STORING A DESTINATION FOR SCAN TO DESKTOP .....	9
BASE SCREEN .....	10
• BASE SCREENS .....	11
• ADDRESS BOOK SCREEN .....	14
• CHANGING THE DISPLAY OF ONE-TOUCH KEYS IN THE ADDRESS BOOK SCREEN .....	15
SCANNING AND TRANSMISSION SEQUENCE .....	16
ORIGINAL SIZES .....	18
• ORIGINAL SIZES THAT CAN BE TRANSMITTED .....	18
• THE SIZE OF THE PLACED ORIGINAL .....	18
<b>2 ENTERING DESTINATIONS</b>	
SPECIFYING DESTINATIONS IN THE ADDRESS BOOK .....	19
• CALLING UP A DESTINATION .....	20
• CHECKING AND DELETING THE SELECTED DESTINATIONS .....	21
USING A SEARCH NUMBER TO SPECIFY A DESTINATION .....	22
ENTER THE ADDRESS MANUALLY .....	23
CALLING UP A DESTINATION FROM A GLOBAL ADDRESS BOOK .....	24
USING THE RESEND FUNCTION .....	26

## 3 BASIC PROCEDURE FOR TRANSMISSION IN SCAN MODE

SCANNING TO E-MAIL, FTP, DESKTOP, AND NETWORK FOLDER .....	27
CHANGING THE EXPOSURE AND EXPOSURE MODE .....	31
CHANGING THE RESOLUTION .....	33
AUTOMATICALLY SCANNING BOTH SIDES OF AN ORIGINAL (2-Sided Original) .....	34
SPECIFYING THE ORIGINAL SCAN SIZE AND SEND SIZE (Enlarge/Reduce) .....	35
• SPECIFYING THE SCAN SIZE OF THE ORIGINAL .....	36
• SPECIFYING THE SEND SIZE OF THE ORIGINAL .....	38
CHANGING THE COLOR MODE .....	39
CHANGING THE FILE FORMAT .....	40
CHANGING THE SUBJECT, FILE NAME, REPLY-TO, AND MESSAGE .....	42

## 4 BASIC PROCEDURE FOR SCANNING IN USB MEMORY MODE

SCANNING TO USB MEMORY .....	45
CHANGING THE EXPOSURE AND EXPOSURE MODE .....	50
CHANGING THE RESOLUTION .....	52
AUTOMATICALLY SCANNING BOTH SIDES OF AN ORIGINAL (2-Sided Original) .....	53
SPECIFYING THE ORIGINAL SCAN SIZE AND SEND SIZE (Enlarge/Reduce) .....	54
• SPECIFYING THE SCAN SIZE OF THE ORIGINAL .....	55
• SPECIFYING THE SEND SIZE OF THE ORIGINAL .....	57
CHANGING THE COLOR MODE .....	58
CHANGING THE FILE FORMAT .....	59
CHANGING THE FILE NAME .....	61

## **5 BASIC PROCEDURE FOR TRANSMISSION IN INTERNET FAX MODE**

<b>SENDING A FAX IN INTERNET FAX MODE</b> .....	62
<b>CHANGING THE EXPOSURE</b> .....	65
<b>CHANGING THE RESOLUTION</b> .....	66
<b>AUTOMATICALLY SCANNING BOTH SIDES OF AN ORIGINAL (2-Sided Original)</b> .....	67
<b>SPECIFYING THE ORIGINAL SCAN SIZE AND SEND SIZE (Enlarge/Reduce)</b> .....	68
• SPECIFYING THE SCAN SIZE OF THE ORIGINAL .....	69
• SPECIFYING THE SEND SIZE OF THE ORIGINAL .....	71
<b>CHANGING THE FILE FORMAT</b> .....	72
<b>CHANGING THE SUBJECT, FILE NAME, AND MESSAGE</b> .....	73

## **6 CHECKING THE STATUS OF TRANSMISSION/RECEPTION JOBS**

<b>JOB STATUS SCREEN</b> .....	75
• JOB QUEUE SCREEN AND COMPLETED JOB SCREEN .....	76
• OPERATION WHEN A JOB IN THE JOB QUEUE IS COMPLETED .....	79
• CHECKING COMPLETED JOBS .....	80
<b>STOPPING A SCAN JOB BEING TRANSMITTED OR WAITING TO BE TRANSMITTED</b> .....	81
<b>GIVING PRIORITY TO A SCAN TRANSMISSION JOB</b> .....	82

## **7 CONVENIENT FUNCTIONS**

<b>SENDING THE SAME IMAGE TO MULTIPLE DESTINATIONS (Broadcast Transmission)</b> .....	83
• BROADCAST TRANSMISSIONS THAT INCLUDE INTERNET FAX DESTINATIONS .....	86
<b>ERASING PERIPHERAL SHADOWS ON THE IMAGE (Erase)</b> .....	88
<b>SCANNING AN ORIGINAL AS TWO SEPARATE PAGES (Dual Page Scan)</b> .....	91
<b>SENDING AN IMAGE AT A SPECIFIED TIME (Timer Transmission)</b> .....	94
<b>WHITENING FAINT COLORS IN THE IMAGE (Suppress Background)</b> .....	97
<b>SCANNING BOTH SIDES OF A CARD ONTO A SINGLE PAGE (Card Shot)</b> .....	100

<b>SCANNING MANY ORIGINALS AT ONCE (Job Build)</b> .....	103
<b>SCANNING ORIGINALS OF DIFFERENT SIZES (Mixed Size Original)</b> .....	106
<b>SCANNING THIN ORIGINALS (Slow Scan Mode)</b> .....	109
<b>STORING SCAN OPERATIONS (Programs)</b> .....	111
<b>FORWARDING A RECEIVED INTERNET FAX TO AN E-MAIL ADDRESS (Inbound Routing Settings)</b> .....	114

## **8 INTERNET FAX FUNCTIONS**

<b>RECEIVING AN INTERNET FAX</b> .....	115
• MANUALLY RECEIVING INTERNET FAXES ..	116
<b>PRINTING FAXES RECEIVED TO MEMORY</b> .....	117
<b>SENDING TWO PAGES AS A SINGLE PAGE (2in1)</b> .....	118
<b>CHANGING THE PRINT SETTINGS FOR THE TRANSACTION REPORT (Transaction Report)</b> ..	121
• CHECKING THE ACTIVITY LOG (Image Sending Activity Report) .....	124
• INFORMATION APPEARING IN THE RESULT COLUMN .....	124
<b>SENDING AN INTERNET FAX FROM A COMPUTER (PC-I-Fax)</b> .....	125

## **9 SCANNING FROM A COMPUTER (PC SCAN MODE)**

<b>BASIC SCANNING PROCEDURE</b> .....	126
---------------------------------------	-----

---

---

# ABOUT THIS MANUAL

This manual explains the procedures for using scan mode, Internet fax mode, USB memory mode, and PC scan mode on the machine.

## Please note

---

- To use the Internet fax function, the Internet fax expansion kit must be installed.
- For information on installing the drivers and software cited in this manual, please refer to the Software Setup Guide and the manuals that are provided with the expansion kits.
- To use the network scanner function, basic network scanner settings, server settings including SMTP and DNS server settings, and destinations must be configured in the Web pages. Configure and store the settings as explained in this manual. These settings require a knowledge of your network environment and therefore must be configured by your network administrator.
- For information on your operating system, please refer to your operating system manual or the online Help function.
- The explanations of screens and procedures in this manual are primarily for Windows® XP. The screens may vary in other versions of Windows.
- Wherever "MX-xxxx" appears in this manual, please substitute your model name for "xxxx".
- Considerable care has been taken in preparing this manual. If you have any comments or concerns about the manual, please contact your dealer or nearest SHARP Service Department.
- This product has undergone strict quality control and inspection procedures. In the unlikely event that a defect or other problem is discovered, please contact your dealer or nearest SHARP Service Department.
- Aside from instances provided for by law, SHARP is not responsible for failures occurring during the use of the product or its options, or failures due to incorrect operation of the product and its options, or other failures, or for any damage that occurs due to use of the product.

## Warning

---

- Reproduction, adaptation or translation of the contents of the manual without prior written permission is prohibited, except as allowed under copyright laws.
- All information in this manual is subject to change without notice.

## Illustrations and the operation panel and touch panel shown in this manual

---

The peripheral devices are generally optional, however, some models include certain peripheral devices as standard equipment. The explanations in this manual assume that a right tray and stand/2 x 500 sheet paper drawer are installed. To further explain certain functions and uses, some explanations assume that additional peripheral devices are installed.

<p>The display screens, messages, and key names shown in the manual may differ from those on the actual machine due to product improvements and modifications.</p>
--



# MANUALS PROVIDED WITH THE MACHINE

Printed manuals and manuals stored in PDF format on the machine's hard drive are provided with the machine. When using the machine, read the appropriate manual for the feature you are using.

## Printed manuals

Manual name	Contents
<b>Safety Guide</b>	This manual contains instructions for using the machine safely and lists the specifications of the machine and its peripheral devices.
<b>Software Setup Guide</b>	This manual explains how to install the software and configure settings to use the machine as a printer or scanner.
<b>Quick Start Guide</b>	This manual provides easy-to-understand explanations of all the functions of the machine in a single volume. Detailed explanations of each of the functions can be found in the manuals in PDF format.
<b>Troubleshooting</b>	This manual explains how to remove paper misfeeds and provides answers to frequently asked questions regarding the operation of the machine in each mode. Refer to this manual when you have difficulty using the machine.
<b>Facsimile Quick Reference Guide</b>	This manual explains the basic procedures for using the fax function of the machine, and provides an overview of the features of the fax function, troubleshooting procedures, and specifications. For detailed information on using the fax function and the system settings for fax, see the "Facsimile Guide" in PDF format.





## Operation manuals in PDF format

The manuals in PDF format provide detailed explanations of the procedures for using the machine in each mode. To view the PDF manuals, download them from the hard drive in the machine. The procedure for downloading the manuals is explained in "How to download the manuals in PDF format" in the Quick Start Guide.

Manual name	Contents
<b>User's Guide</b>	This manual provides information, such as basic operation procedures, how to load paper, and machine maintenance.
<b>Copier Guide</b>	This manual provides detailed explanations of the procedures for using the copy function.
<b>Printer Guide</b>	This manual provides detailed explanations of the procedures for using the printer function.
<b>Facsimile Guide</b>	This manual provides detailed explanations of the procedures for using the fax function and the "System Settings" that are related to fax.
<b>Scanner Guide (This manual)</b>	This manual provides detailed explanations of the procedures for using the scanner function and the Internet fax function.
<b>Document Filing Guide</b>	This manual provides detailed explanations of the procedures for using the document filing function. The document filing function allows you to save the document data of a copy or fax job, or the data of a print job, as a file on the machine's hard drive. The file can be called up as needed.
<b>System Settings Guide</b>	This manual explains the "System Settings", which are used to configure a variety of parameters to suit the aims and the needs of your workplace. Current settings can be displayed or printed out from the "System Settings".

## Icons used in the manuals

The icons in the manuals indicate the following types of information:

	This alerts you to a situation where there is a risk of machine damage or failure.		This indicates the name of a system setting and provides a brief explanation of the setting. For detailed information on each system setting, see the System Settings Guide. <b>When "System Settings:" appears:</b> A general setting is explained. <b>When "System Settings (Administrator):" appears:</b> A setting that can only be configured by an administrator is explained.
	This provides a supplemental explanation of a function or procedure.		
	This explains how to cancel or correct an operation.		

# 1



# BEFORE USING THE MACHINE AS A NETWORK SCANNER

This chapter provides basic information that is necessary to use the machine as a network scanner.

## NETWORK SCANNER FUNCTION

The network scanner function of the machine can be used to scan an original, create an image file, and send the file over a network to a computer, FTP server, or other destination. Scanning is also possible from your computer using a TWAIN-compliant application.

The network scanner function provides the following scanning modes.

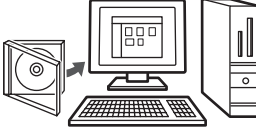
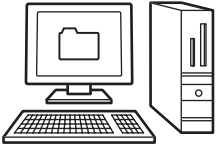
Scan modes		3. BASIC PROCEDURE FOR TRANSMISSION IN SCAN MODE (page 27)	
<b>Scan to E-mail</b> The scanned file is sent by e-mail. 	<b>Scan to FTP*1</b> The scanned file is sent to a specified directory of an FTP server. 	<b>Scan to Desktop*2</b> The scanned file is sent to a specified folder on your computer. 	<b>Scan to Network Folder*3</b> The scanned file is sent to a shared folder on a Windows computer on the same network as the machine. 

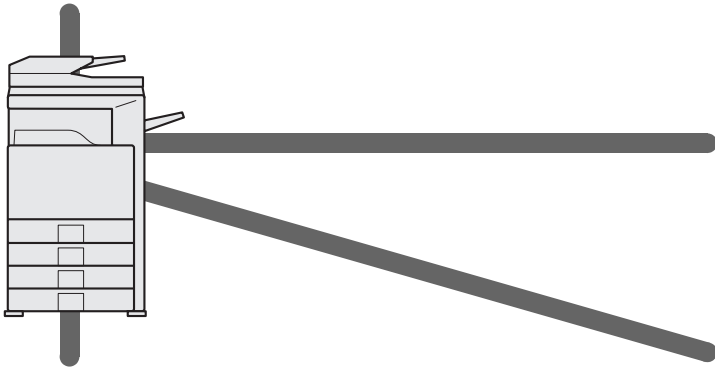

### USB memory mode

The scanned file is sent to and stored in a USB memory device connected to the machine.



4. BASIC PROCEDURE FOR SCANNING IN USB MEMORY MODE (page 45)

### Internet fax mode

The scanned file is sent as an Internet fax. Reception of Internet faxes is also possible.

5. BASIC PROCEDURE FOR TRANSMISSION IN INTERNET FAX MODE (page 62)

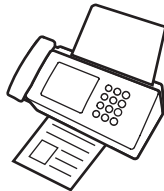

### PC scan mode\*4

A TWAIN-compliant application on a computer connected to the same network as the machine is used to scan a document or image.

9. SCANNING FROM A COMPUTER (PC SCAN MODE) (page 126)



\*1 When the file is sent, it is also possible to send an e-mail to a previously stored e-mail address to inform the recipient of the location of the file. (This is called "Scan to FTP (Hyperlink)".)

\*2 To use Scan to Desktop, software must be installed from the "Sharpdesk/Network Scanner Utilities" CD-ROM in the network scanner expansion kit that accompanies the machine. For the procedures for installing the software, see the "Sharpdesk Installation Guide".

\*3 Transmission is possible to computers running the following operating systems: Windows 98/NT 4.0/2000/XP/Server 2003

\*4 The scanner driver must be installed from the "Software CD-ROM" provided with the machine. Operating systems that can be used are Windows 98/Me/2000/XP/Server 2003.

# PREPARATIONS FOR USE AS A NETWORK SCANNER

## MAKE SURE THE MAIN POWER SWITCH IS IN THE "ON" POSITION

The main power is "on" when the main power indicator on the right side of the operation panel is lit.

If the main power indicator is not lit, the main power is off. Switch the main power switch to the "on" position and press the [POWER] key (⏻) on the operation panel.

If the Internet fax function will be used, and in particular if reception or timer transmission will take place at night, always keep the main power switch in the "on" position.

 When the [POWER SAVE] key indicator light is blinking, the machine is in auto power shut-off mode. If the [POWER SAVE] key is pressed when the indicator is on, the indicator will turn off and the machine will return to the ready state after a brief interval.

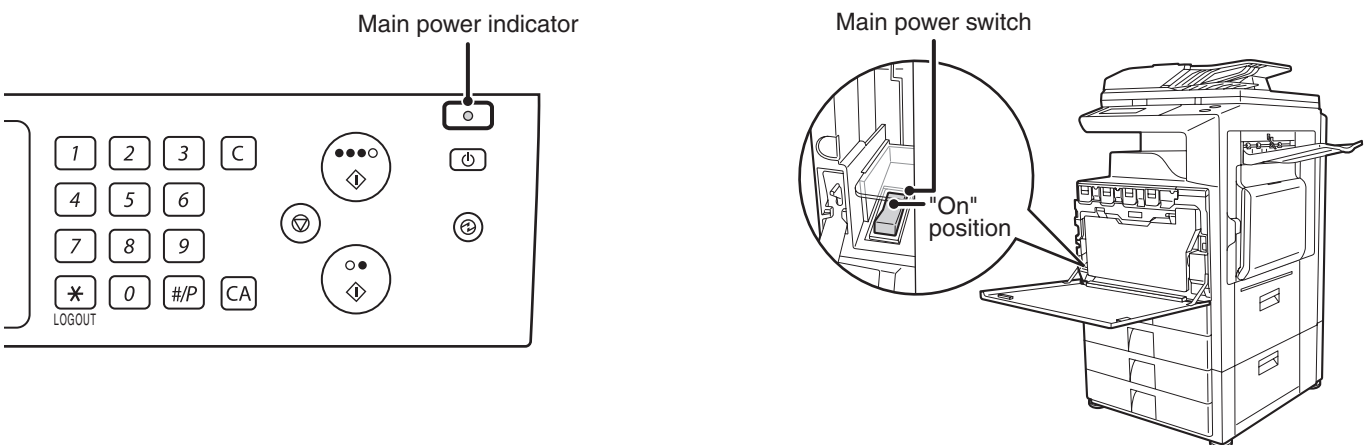

## CHECKING THE DATE AND TIME

To check if the date and time are set correctly in the machine, follow the steps below.

1



Press the [SYSTEM SETTINGS] key.

2

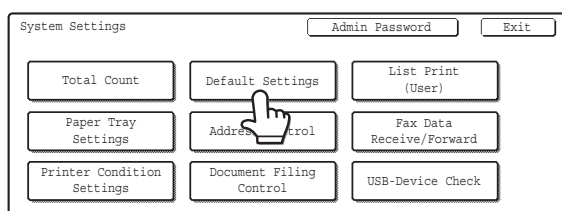

Touch the [Default Settings] key.

3

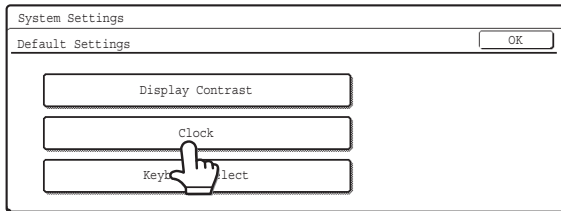

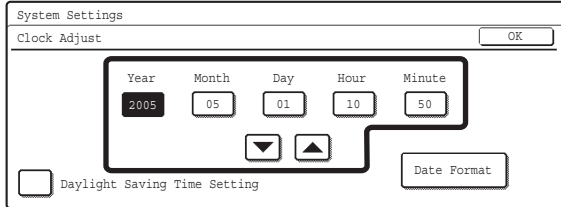

Touch the [Clock] key.

4



Check the date and time.

- If the date and time are correct, touch the [OK] key.
- To change the date and time, touch the [Year], [Month], [Day], [Hour], and/or [Minute] keys and use the   keys to adjust each value. When the correct date and time appear, touch the [OK] key.

## STORING SENDER INFORMATION

### Before using Scan to E-mail

Store the default sender name in "Sender Name" and the reply e-mail address in "Reply Address". These will be used when a sender name is not selected.



#### System Settings (Administrator): Default Sender Set

This is used to store the sender name and e-mail address that is used when a sender is not selected.

### Before using Internet fax

Store the sender name in "Name" and the sender Internet fax address in "Own Address".



#### System Settings (Administrator): I-Fax Own Name and Address Set

Use this setting to program the sender's name and sender's address.

## SETTINGS REQUIRED IN THE WEB PAGE

In order to use the network scanner function, basic network scanner settings, server settings including SMTP and DNS server settings, and the sender's address must be configured in the Web pages.

### • Basic network scanner settings

To configure network scanner settings, click [Application Settings] and then [Network Scanner Settings] in the Web page menu. (Administrator rights are required.)

### • Server settings

To configure server settings, click [Network Settings] and then [Services Settings] in the Web page menu. (Administrator rights are required.)

# STORING DESTINATION ADDRESSES FOR EACH SCAN MODE IN THE ADDRESS BOOK

To use Scan to FTP, Scan to Desktop, and Scan to Network Folder, destinations must be stored in the address book. Although destinations for Scan to E-mail and Internet fax do not need to be stored in the address book (they can be entered directly or looked up in a global address book at the time of transmission), storing these destinations in the address book makes it easier to specify them. Store each type of destination as explained below.

## Scan mode destinations

- Scan to FTP: Click [Address Book] in the Web page menu, and click the [Add] button that appears. Select [FTP] in [Address Type] and then store the sender name and address.
- Scan to Network Folder: Click [Address Book] in the Web page menu, and click the [Add] button that appears. Select [Network Folder] in [Address Type] and then store the sender name and address.
- Scan to E-mail: Click [Address Book] in the Web page menu, and click the [Add] button that appears. Select [E-mail] in [Address Type] and then store the address. The address can also be stored in the system settings.
- Scan to Desktop: See "[STORING A DESTINATION FOR SCAN TO DESKTOP](#)" (page 9). The sender name and sender address can also be stored in the Web pages. Click [Address Book] in the Web page menu, and click the [Add] button that appears. Select [Desktop] in [Address Type] and then store the sender name and address.

**Internet fax mode:** Click [Address Book] in the Web page menu, and click the [Add] button that appears. Select [Internet Fax] in [Address Type] and then store the sender name and address. The address can also be stored in the system settings.



### System Settings: Direct Address/Program

This is used to store destination addresses for Scan to E-mail and Internet fax.

# STORING A DESTINATION FOR SCAN TO DESKTOP

To store your computer in the machine as the destination of Scan to Desktop, Network Scanner Tool must be installed from the "Sharpdesk/Network Scanner Utilities" CD-ROM in the network scanner expansion kit that accompanies the machine. To scan an image to your computer, the Network Scanner Tool must be running on your computer.

## INSTALLING THE NETWORK SCANNER TOOL

To install Network Scanner Tool, see "Sharpdesk Installation Guide" in the network scanner expansion kit that accompanies the machine. When a standard installation is performed, Network Scanner Tool is installed with Sharpdesk.

When you restart your computer after installing the Network Scanner Tool, the Setup Wizard will start automatically. Follow this wizard to set up the Network Scanner Tool. This will store your computer in the machine as a destination for Scan to Desktop. The stored destination will be displayed as one-touch keys in the Address Book screen.

The following window appears while the Network Scanner Tool is being set up. The item selected in "My Profiles" (C) will be the name of the one-touch key.

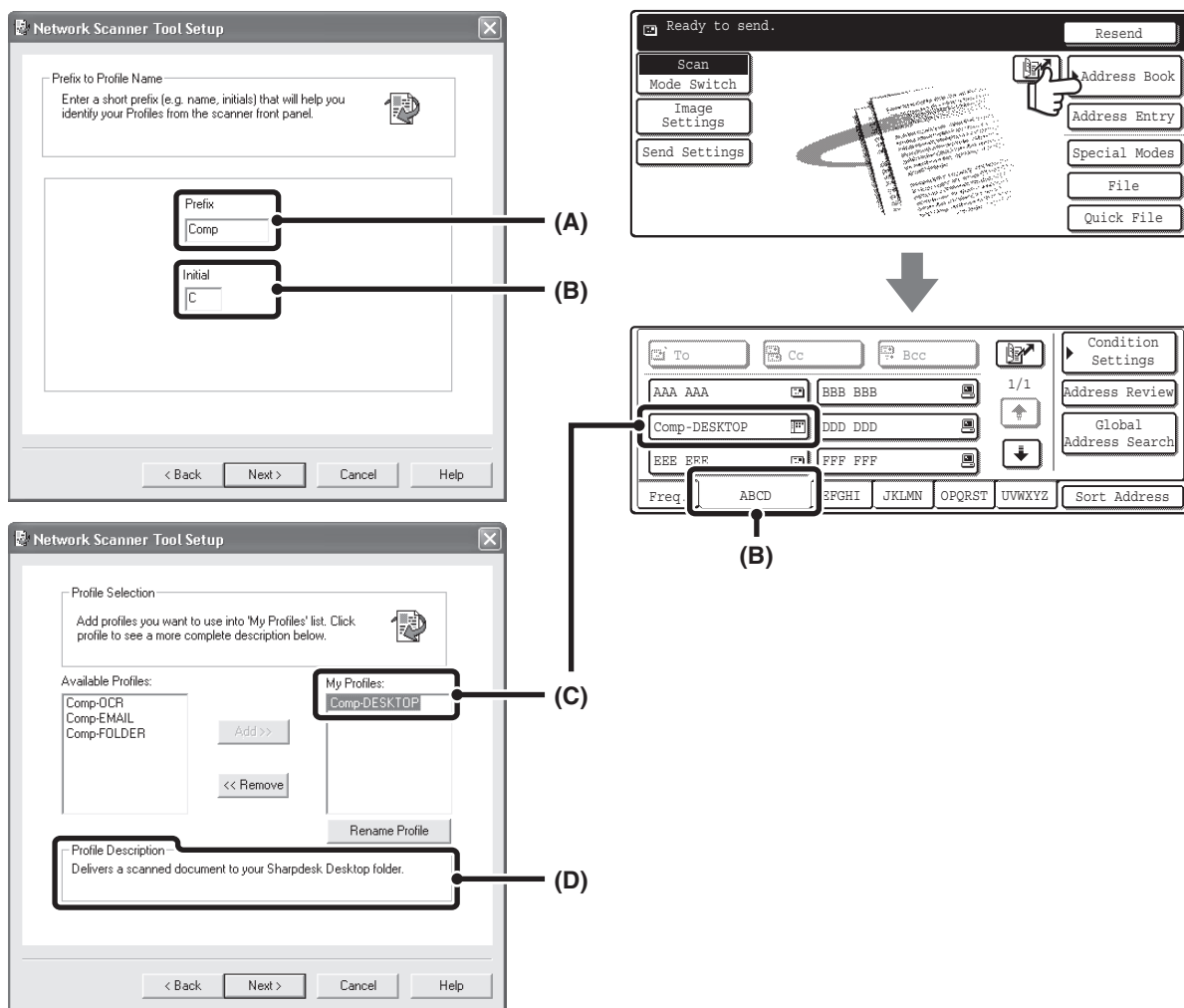

The profile name is determined by the combination of the text entered in "Prefix" (A) and the profile\*. The one-touch key is assigned to an index tab in the Address Book screen based on the text entered in "Initial" (B). \* This defines how an image sent to your computer is processed. For more information, see profile explanation (D).

## ADDING DESTINATIONS

Up to 10 computers can be stored as destinations for Scan to Desktop. (To store more than 10 destinations, a license kit is required.) Store Scan to Desktop destinations by installing the Network Scanner Tool on each computer.

# BASE SCREEN

Scan mode, Internet fax mode, USB memory mode, and PC scan mode are operated by selecting settings and commands in the base screens of these modes. To display the base screen of a mode, press the [IMAGE SEND] key and then touch the [Mode Switch] key to select the desired mode.

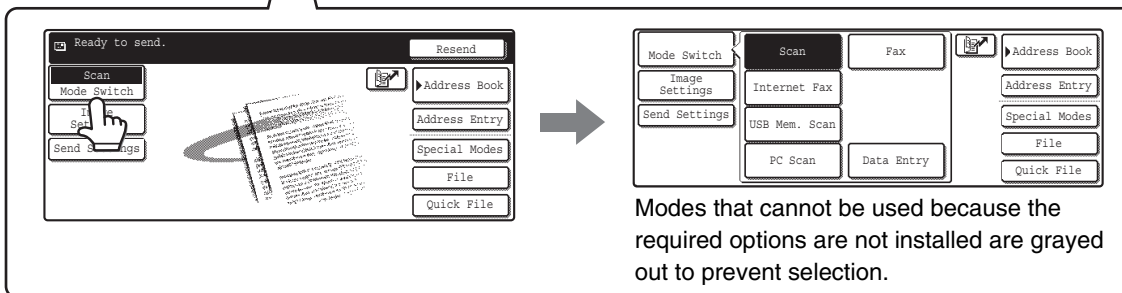
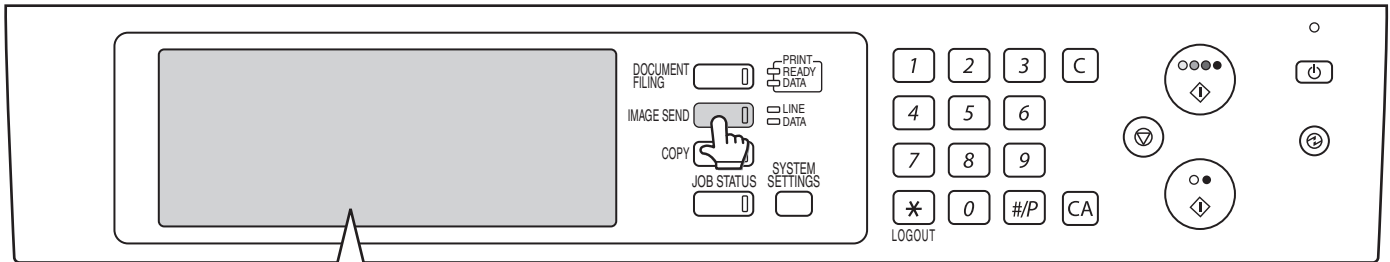

When sending an image, you can use a transmission destination stored in the Address Book. The Address Book screen is shared by scan mode, Internet fax mode, and fax mode.

Touch the [Address Book] key in the base screen to switch to the Address Book screen. Touch the [Condition Settings] key in the Address Book screen to switch to the base screen.

## Base screen of scan mode



## Address Book screen

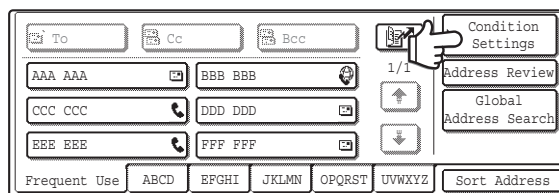

The procedures in this manual assume that the base screen of scan mode appears when the [IMAGE SEND] key is pressed.

**System Settings (Administrator): Default Display Setting**  
One of the following screens can be selected for the initial screen that appears when the [IMAGE SEND] key is pressed.

- Base screen of each mode (scan mode, Internet fax mode and fax mode)
- Address book screen (alphabetical/custom index)

# BASE SCREENS

Settings are selected in the base screen of each mode.

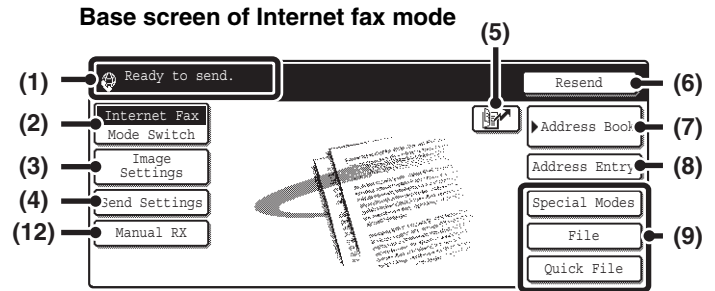
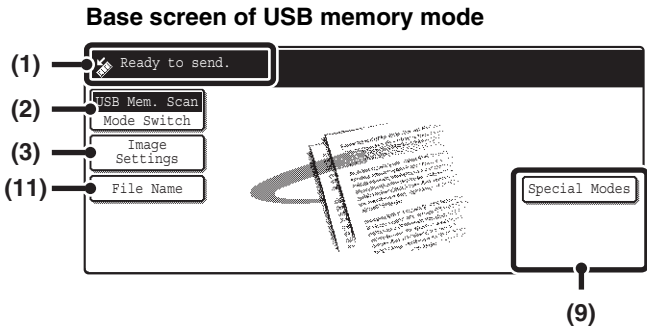
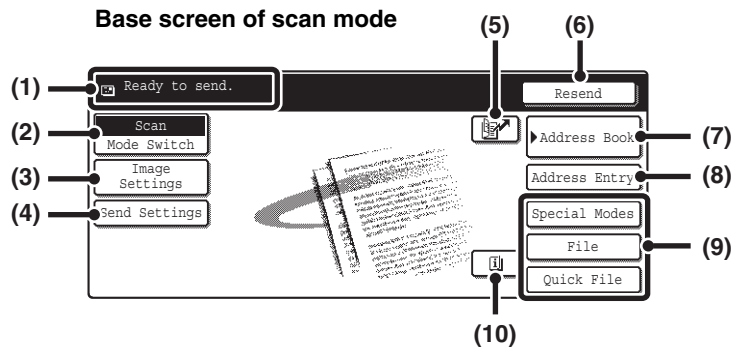

- (1) **Various messages are displayed here.**  
The icon of the selected mode appears on the left.
- (2) **[Mode Switch] key**  
Use this key to change the mode of the image send function.  
➤ [BASE SCREEN](#) (page 10)
- (3) **[Image Settings] key**  
Touch this key to select scan settings (exposure, resolution, original size, color mode, format, special modes).  
➤ [\[Image Settings\] key](#) (page 13)
- (4) **[Send Settings] key**  
Touch this key to change the subject, file name, reply-to, or message text, which have been previously stored in the Web page.  
➤ Scan mode: [CHANGING THE SUBJECT, FILE NAME, REPLY-TO, AND MESSAGE](#) (page 42)  
Internet fax mode: [CHANGING THE SUBJECT, FILE NAME, AND MESSAGE](#) (page 73)

- (5) **🔍 key**  
Touch this key to search for a destination using a search number.\*  
\* 3-digit number assigned to a destination when it is stored.  
➤ [USING A SEARCH NUMBER TO SPECIFY A DESTINATION](#) (page 22)
- (6) **[Resend] key / [Next Address] key**  
The destinations of the most recent eight transmissions by Scan to E-mail, fax and/or Internet fax are stored. To select one of these destinations, touch the desired destination. After a destination is selected, this key changes to the [Next Address] key.  
➤ [USING THE RESEND FUNCTION](#) (page 26)  
➤ [CALLING UP A DESTINATION](#) (page 20)
- (7) **[Address Book] key**  
Touch this key to use a one-touch key or a group key. When the key is touched, the Address Book screen appears.  
➤ [SPECIFYING DESTINATIONS IN THE ADDRESS BOOK](#) (page 19)
- (8) **[Address Entry] key**  
Touch this key to manually enter a destination address instead of using a one-touch key.  
➤ [ENTER THE ADDRESS MANUALLY](#) (page 23)



**(9) Customized keys**

The keys that appear here can be changed to show settings or functions that you prefer. The keys are changed in "Customize Key Setting" in the system settings (administrator). The following keys appear by factory default:

• **[Special Modes] key**

Touch this key to use a convenient special mode. This is the same [Special Modes] key that appears when the [Image Settings] key is touched.

• **[File] key, [Quick File] key\***

Touch one of these keys to use the File function or Quick File function of document filing mode. For more information on the document filing function, see the Document Filing Guide.

\* These do not appear in the base screen of USB memory mode.

**(10)  key**

This key appears when a special mode or two-sided scanning is selected. Touch the key to display the selected special modes.

 [Checking what special modes are selected](#) (page 13)

**(11) [File Name] key**

Touch this key to store or change a file name. A file name previously stored in the Web pages can also be changed.

**(12) [Manual RX] key**

Touch this key to receive an Internet fax manually.

 [MANUALLY RECEIVING INTERNET FAXES](#) (page 116)

 This manual uses the base screen of scan mode as an example when operations common to all modes are explained.

## Customizing displayed keys (customized keys)

You can select the keys that appear in the lower right corner of the base screen. Keys that can be selected include keys of convenient functions (Special modes). Set these keys to functions that you frequently use to access the functions with a single touch. The customized keys are configured using "Customize Key Setting" in the system settings (administrator). The [Special Modes] key, the [File] key\* and the [Quick File] key\* appear by factory default.

\* These do not appear in the base screen of USB memory mode.

**Example: Displaying the Dual Page Scan, Erase and Address Review keys as customized keys.**

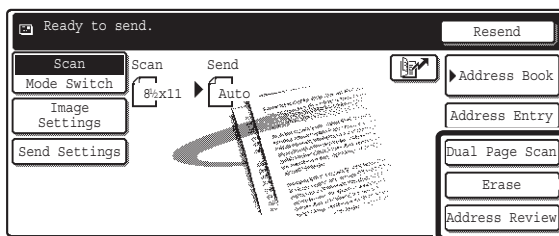

These three keys can be changed as desired.

-  If the [Special Modes] key is not displayed as a customized key, touch the [Image Settings] key in the base screen to display the [Special Modes] key.
- The functions that can be selected for the customized keys vary depending on the mode.

 **System Settings (Administrator): Customize Key Setting**  
These are used to select the keys that appear in the base screen.

## [Image Settings] key

When the [Image Settings] key is touched, the [Special Modes] key and keys for selecting scan settings appear. The current setting of each scan setting key appears in the top of the key.

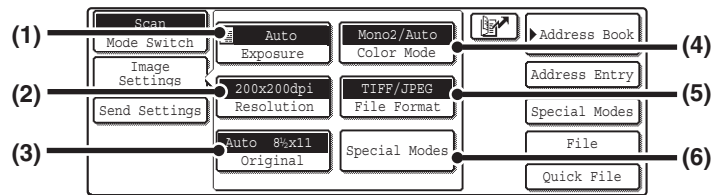

### (1) [Exposure] key

Touch this key to select the exposure for scanning.

☞ Scan mode:

[CHANGING THE EXPOSURE AND EXPOSURE MODE \(page 31\)](#)

USB memory mode:

[CHANGING THE EXPOSURE AND EXPOSURE MODE \(page 50\)](#)

Internet fax mode:

[CHANGING THE EXPOSURE \(page 65\)](#)

### (2) [Resolution] key

Touch this key to select the resolution for scanning.

☞ Scan mode:

[CHANGING THE RESOLUTION \(page 33\)](#)

USB memory mode:

[CHANGING THE RESOLUTION \(page 52\)](#)

Internet Fax mode:

[CHANGING THE RESOLUTION \(page 66\)](#)

### (3) [Original] key

Touch this key to select the original size, the original orientation, two-sided scanning, and the send size.

☞ Scan mode:

[AUTOMATICALLY SCANNING BOTH SIDES OF AN ORIGINAL \(2-Sided Original\) \(page 34\)](#)

[SPECIFYING THE ORIGINAL SCAN SIZE AND SEND SIZE \(Enlarge/Reduce\) \(page 35\)](#)

USB memory mode:

[AUTOMATICALLY SCANNING BOTH SIDES OF AN ORIGINAL \(2-Sided Original\) \(page 53\)](#)

[SPECIFYING THE ORIGINAL SCAN SIZE AND SEND SIZE \(Enlarge/Reduce\) \(page 54\)](#)

Internet fax mode:

[AUTOMATICALLY SCANNING BOTH SIDES OF AN ORIGINAL \(2-Sided Original\) \(page 67\)](#)

[SPECIFYING THE ORIGINAL SCAN SIZE AND SEND SIZE \(Enlarge/Reduce\) \(page 68\)](#)

### (4) [Color Mode] key

Touch this key to select the color mode for scanning.

This key does not appear in Internet fax mode.

☞ Scan mode:

[CHANGING THE COLOR MODE \(page 39\)](#)

USB memory mode:

[CHANGING THE COLOR MODE \(page 58\)](#)

### (5) [File Format] key

Touch this key to change the file format (file type) for the scanned image file.

☞ Scan mode:

[CHANGING THE FILE FORMAT \(page 40\)](#)

USB memory mode:

[CHANGING THE FILE FORMAT \(page 59\)](#)

Internet fax mode:

[CHANGING THE FILE FORMAT \(page 72\)](#)

### (6) [Special Modes] key

Touch this key to use a convenient special mode. Open the special modes screen from here when "Customize Key Setting" in the system settings (administrator) has been changed so that the [Special Modes] key is not displayed in the base screen.

## Checking what special modes are selected

The  key appears in the base screen when a special mode or two-sided scanning is selected.

The  key can be touched to display the selected special modes. To close the screen, touch the [OK] key.

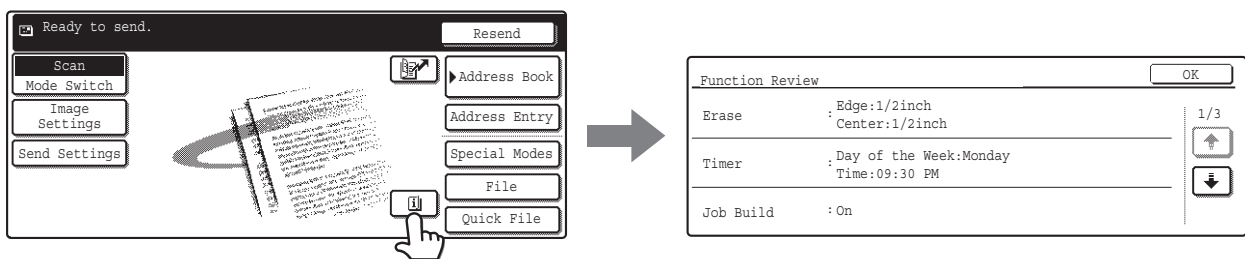

# ADDRESS BOOK SCREEN

This screen is used to select transmission destinations.

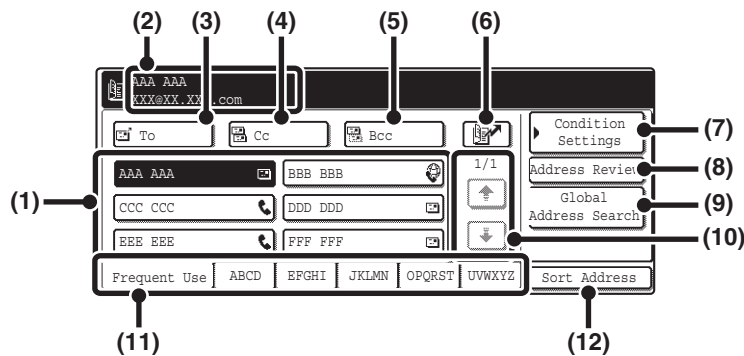

**(1) One-touch key display**

The destinations (one-touch keys) stored in each index are displayed. This manual refers to keys in which destinations and groups are stored as one touch keys.

➤ [CALLING UP A DESTINATION](#) (page 20)

**(2) This shows the selected destination.**

**(3) [To] key**

Touch this key to enter the selected destination (one-touch key).

➤ [CALLING UP A DESTINATION](#) (page 20)

**(4) [Cc] key**

When using Scan to E-mail, touch the [Cc] key when you wish to send a "Carbon copy" of the e-mail to an additional destination.

**(5) [Bcc] key**

When using Scan to E-mail, touch the [Bcc] key when you wish to send a "Blind carbon copy" of the e-mail to an additional destination.

When an address is specified as a Bcc recipient, other recipients will not know that the address is a recipient. This key only appears when Bcc has been enabled using "Bcc Setting" in the system settings (administrator).

**(6) [Search] key**

Touch this key to search for a destination using a search number\*.

\* A 3-digit number assigned to a one-touch key or group key when it is stored.

➤ [USING A SEARCH NUMBER TO SPECIFY A DESTINATION](#) (page 22)

**(7) [Condition Settings] key**

Touch this key to select send settings. When the key is touched, the base screen appears.

➤ [BASE SCREEN](#) (page 10)

**(8) [Address Review] key**

Touch this key to view a list of the selected destinations. Destination selections can be changed.

➤ [CHECKING AND DELETING THE SELECTED DESTINATIONS](#) (page 21)

**(9) [Global Address Search] key**

When the use of an LDAP server has been enabled in the machine's Web page, an address for a transmission can be obtained from a global address book.

➤ [CALLING UP A DESTINATION FROM A GLOBAL ADDRESS BOOK](#) (page 24)

**(10) Page change keys**

Use these keys to change pages when more one-touch keys have been stored than can be displayed on one page.

**(11) Index tab**

Touch this to change indexes.

➤ [Index display](#) (page 15)

**(12) [Sort Address] key**

Touch this key to change the index tabs to custom indexes or to display one-touch keys by send mode.

➤ [CHANGING THE DISPLAY OF ONE-TOUCH KEYS IN THE ADDRESS BOOK SCREEN](#) (page 15)



- Icons appear in the one-touch keys in the address book to indicate which mode is used for transmission. ➤ [SPECIFYING DESTINATIONS IN THE ADDRESS BOOK](#) (page 19)
- The Scan to Desktop destination is stored when Network Scanner Tool is installed from the CD-ROM in the network scanner expansion kit that accompanies the machine. The sender name and sender address can also be stored in the Web pages. Click [Address Book] in the Web page menu, and click the [Add] button that appears. Select [Desktop] in [Address Type] and then store the sender name and address. ➤ [STORING A DESTINATION FOR SCAN TO DESKTOP](#) (page 9)
- For information on storing addresses in the address book, see "[STORING DESTINATION ADDRESSES FOR EACH SCAN MODE IN THE ADDRESS BOOK](#)" (page 8).



- System Settings: Address Control**  
This can be used to store addresses of Scan to E-mail and Internet fax destinations in one-touch keys.
- System Settings (Administrator): The Number of Direct Address Keys Displayed Setting**  
This is used to change the number of one-touch keys displayed in the Address Book screen.
- System Settings (Administrator): Bcc Setting**  
This setting enables or disables Bcc delivery. When enabled, the [Bcc] key appears in the Address Book screen.
- System Settings (Administrator): Default Display Setting**  
One of the following screens can be selected for the initial screen that appears when the [IMAGE SEND] key is pressed.
  - Base screen of each mode (scan mode, Internet fax mode and fax mode)
  - Address book screen (alphabetical/custom index)

# CHANGING THE DISPLAY OF ONE-TOUCH KEYS IN THE ADDRESS BOOK SCREEN

You can show only destinations of a specific transmission mode in the Address Book screen, or change the displayed index tabs from the alphabetical tabs to the custom tabs. The procedure for selecting destinations does not change.

1

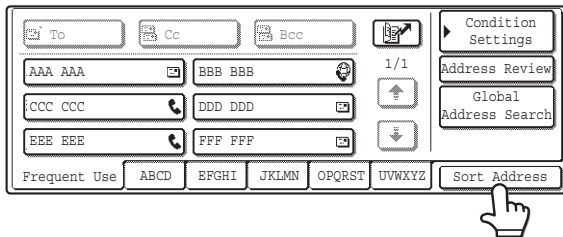

Touch the [Sort Address] key.

2

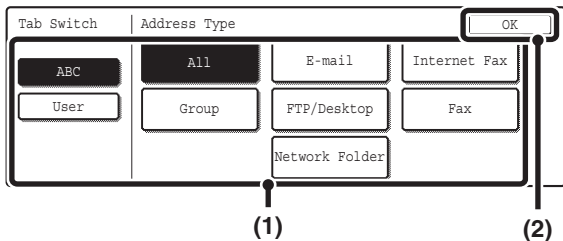

Change the display mode.

(1) Touch the key of the mode or tab that you wish to display.

- To show only the one-touch keys of a particular send mode, touch the desired mode key under "Address Type".
- To change the index tabs to the custom indexes, touch the [User] key under "Tab Switch".

(2) Touch the [OK] key.

## Index display

Indexes make it easy to search for a destination (one-touch key). Destinations are grouped on alphabetical index tabs. To display a stored destination, touch the appropriate index tab. It is convenient to have frequently used destinations appear in the [Frequent Use] index. Specify that a destination be displayed in the [Frequent Use] index when you store the destination.

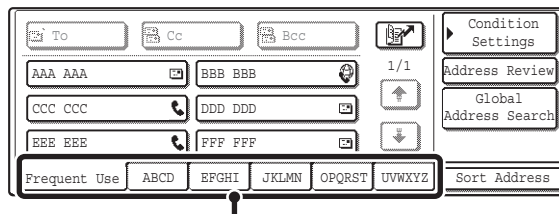

Index tab

The destinations can be displayed in alphabetical order by initial.

Each time the displayed index tab is touched, the display order changes in the following order: search numbers (page 22), ascending names, descending names, search numbers... When the display order is changed, the display order of the other index tabs also changes.

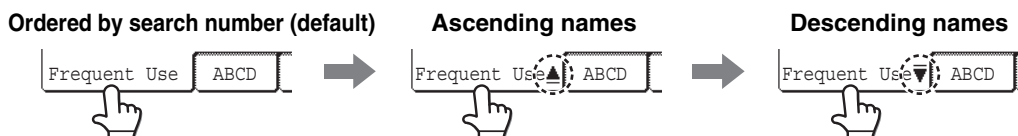

Index names can be changed using "Custom Index" in the system settings, allowing you to create groups of one-touch keys that can be easily recognized. For more information on "Custom Index", see the System Settings Guide.



### System Settings: Custom Index

This setting is used to store custom index names. The custom index where a one-touch key appears is specified when the transmission destination is stored in the key.

# SCANNING AND TRANSMISSION SEQUENCE

This section explains the basic procedure for scanning and transmission. Select settings in the order shown below to ensure smooth transmission.

For the detailed procedures for selecting the settings, see the explanation of each setting in this manual.

## Place the original

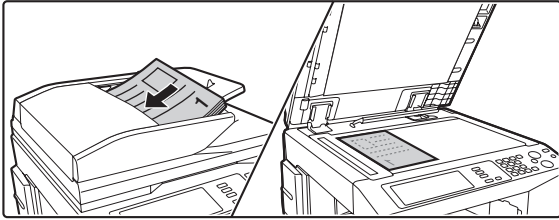

Place the original in the document feeder tray of the automatic document feeder, or on the document glass.

- [3. BASIC PROCEDURE FOR TRANSMISSION IN SCAN MODE](#) (page 27)
- [4. BASIC PROCEDURE FOR SCANNING IN USB MEMORY MODE](#) (page 45)
- [5. BASIC PROCEDURE FOR TRANSMISSION IN INTERNET FAX MODE](#) (page 62)



## Change the mode

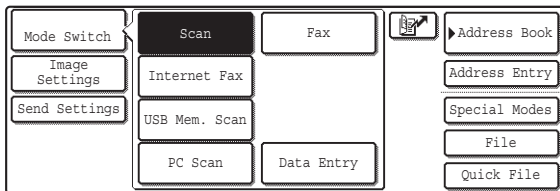

Select the mode that you wish to use for scanning and transmission.

- [BASE SCREEN](#) (page 10)
- Scan modes:
  - Scan to E-mail, Scan to FTP, Scan to Desktop, Scan to Network Folder
  - [3. BASIC PROCEDURE FOR TRANSMISSION IN SCAN MODE](#) (page 27)
- Internet fax mode: Internet fax transmission
  - [5. BASIC PROCEDURE FOR TRANSMISSION IN INTERNET FAX MODE](#) (page 62)
- USB memory mode:
  - Store scanned data in a USB memory device
  - [4. BASIC PROCEDURE FOR SCANNING IN USB MEMORY MODE](#) (page 45)
- PC Scan mode:
  - Use a scanner driver to scan from a computer
  - [9. SCANNING FROM A COMPUTER \(PC SCAN MODE\)](#) (page 126)



## Select original settings

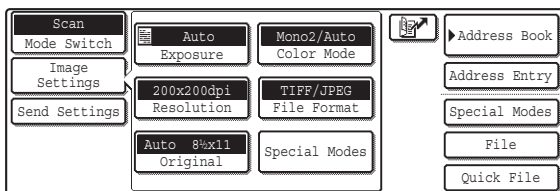

Settings can be selected for scanning the original.

- Exposure • Resolution
- Scan size • Send size
- Scanning of two-sided original • Color mode
- File format • Special Modes • Advanced send settings
  - [\[Image Settings\] key](#) (page 13)
  - [7. CONVENIENT FUNCTIONS](#) (page 83)
  - Scan mode: [CHANGING THE SUBJECT, FILE NAME, REPLY-TO, AND MESSAGE](#) (page 42)
  - Internet fax mode: [CHANGING THE SUBJECT, FILE NAME, AND MESSAGE](#) (page 73)



## Select convenient special modes

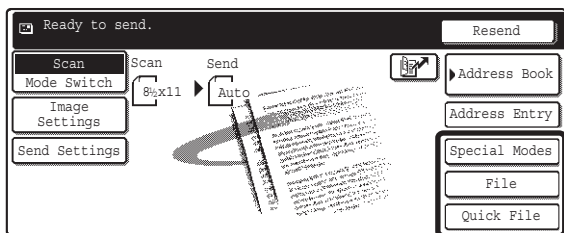

Convenient special modes and document filing settings can be selected.

➤ [7. CONVENIENT FUNCTIONS](#) (page 83)



## Enter the destination

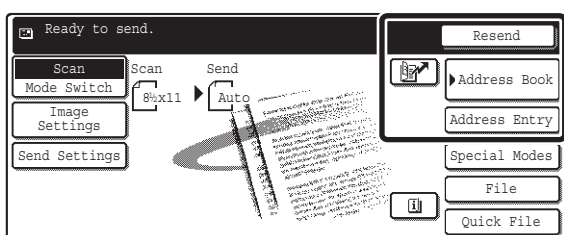

Specify the destination of the scan transmission.

- [Address Book] key: Select a destination that is stored in the Address Book or look up a destination in a global address book.
  - [SPECIFYING DESTINATIONS IN THE ADDRESS BOOK](#) (page 19)
  - [CALLING UP A DESTINATION FROM A GLOBAL ADDRESS BOOK](#) (page 24)
- [Address Entry] key: Manually enter an address for Scan to E-mail or Internet fax.
  - [ENTER THE ADDRESS MANUALLY](#) (page 23)
-  key: Use a search number to specify an address stored in the Address Book.
  - [USING A SEARCH NUMBER TO SPECIFY A DESTINATION](#) (page 22)
- [Resend] key: The destinations of the most recent eight transmissions by Scan to E-mail, fax and/or Internet fax are stored. These destinations can be selected.
  - [USING THE RESEND FUNCTION](#) (page 26)



## Start scanning and transmission

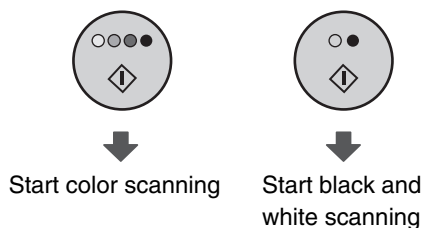

Start scanning and transmission.

If the original is placed on the document glass, follow these steps to start scanning and transmission:

- (1) Press the [COLOR START] key (○●●●) or the [BLACK & WHITE START] key (○●).
- (2) When scanning is finished, replace the original with the next original.
- (3) Press the [COLOR START] key (○●●●) or the [BLACK & WHITE START] key (○●).
- (4) Repeat (2) and (3) until all originals have been scanned.
- (5) Touch the [Read-End] key.



- The [COLOR START] key (○●●●) cannot be used in Internet fax mode.
- After the original is scanned, the settings revert to the default settings.



### To cancel scanning...

Press the [STOP] key (⊖) to cancel the operation.

# ORIGINAL SIZES

## ORIGINAL SIZES THAT CAN BE TRANSMITTED

The following original sizes can be transmitted

	Minimum original size	Maximum original size
Using the automatic document feeder	8-1/2" (width) x 5-1/2" (length) (A5: 210 mm (width) x 148 mm (length)) 5-1/2" (width) x 8-1/2" (length) (A5R: 148 mm (width) x 210 mm (length))	11-5/8" (width) x 31-1/2"* (length) (297 mm (width) x 800 mm* (length)) *A long original can be transmitted. (Scanning will take place in Mono 2 mode.)
Using the document glass		11-5/8" (width) x 17" (length) (297 mm (width) x 432 mm (length))

## THE SIZE OF THE PLACED ORIGINAL

When a standard size original is placed, the original size is automatically detected and displayed in the base screen as the "Scan" size.

When the automatic original detection function is operating and the original is a non-standard size, the closest standard size may be displayed or the original size may not appear. In this event, manually set the correct original size.

- ☞ Scan mode: [SPECIFYING THE SCAN SIZE OF THE ORIGINAL](#) (page 36)
- USB memory mode: [SPECIFYING THE SCAN SIZE OF THE ORIGINAL](#) (page 55)
- Internet fax mode: [SPECIFYING THE SCAN SIZE OF THE ORIGINAL](#) (page 69)

## STANDARD SIZES

The standard sizes are set in "Original Size Detector Setting" in the system settings (administrator). The factory default setting is "Inch-1".

### List of original size detector settings

Selections	Detectable original sizes	
	Document glass	Document feeder tray (automatic document feeder)
Inch-1	11" x 17", 8-1/2" x 14", 8-1/2" x 11", 8-1/2" x 11"R, 5-1/2" x 8-1/2"	11" x 17", 8-1/2" x 14", 8-1/2" x 11", 8-1/2" x 11"R, 5-1/2" x 8-1/2", A4, A3
Inch-2	11" x 17", 8-1/2" x 13", 8-1/2" x 11", 8-1/2" x 11"R, 5-1/2" x 8-1/2"	11" x 17", 8-1/2" x 13", 8-1/2" x 11", 8-1/2" x 11"R, 5-1/2" x 8-1/2", A4, A3
AB-1	A3, A4, A4R, A5, B4, B5, B5R	A3, A4, A4R, A5, B4, B5, B5R, 8-1/2" x 11", 8-1/2" x 14", 11" x 17"
AB-2	A3, A4, A4R, A5, B5, B5R, 216 mm x 330 mm	A3, A4, A4R, A5, B4, B5, B5R, 8-1/2" x 11", 11" x 17", 216 mm x 330 mm
AB-3	A4, A4R, A5, B4, 8K, 16K, 16KR	A3, A4, A4R, A5, B4, 8K, 16K, 16KR, 8-1/2" x 11", 11" x 17", 216 mm x 330 mm

# 2

## ENTERING DESTINATIONS

This chapter explains how to specify destination addresses, including selecting an address from the Address Book and retrieving an address by entering a search number.

### SPECIFYING DESTINATIONS IN THE ADDRESS BOOK

The Address Book screen shows destinations as one-touch keys.

The destinations are displayed in order by search number. To make it easy to find a destination, the destinations are grouped on alphabetical index tabs.

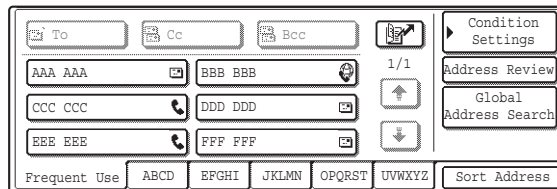

The Address Book screen shows the destinations of all modes of the image send function. Each one-touch key shows the name of the destination and an icon indicating the mode to be used.

Icon	Mode used
	Fax
	Group key with multiple destinations, such as Scan to E-mail and Internet fax destinations
	Scan to E-mail
	Internet fax
	Scan to FTP
	Scan to Network Folder
	Scan to Desktop

- The Scan to Desktop destination is stored when Network Scanner Tool is installed from the CD-ROM in the network scanner expansion kit that accompanies the machine. The sender name and sender address can also be stored in the Web pages. Click [Address Book] in the Web page menu, and click the [Add] button that appears. Select [Desktop] in [Address Type] and then store the sender name and address.  
➔ [STORING A DESTINATION FOR SCAN TO DESKTOP](#) (page 9)
- For information on storing addresses in the address book, see "[STORING DESTINATION ADDRESSES FOR EACH SCAN MODE IN THE ADDRESS BOOK](#)" (page 8).



#### System Settings: Address Control

This is used to store addresses of Scan to E-mail and Internet fax destinations in one-touch keys.



# CALLING UP A DESTINATION

A destination is called up by selecting its one-touch key.

**1**

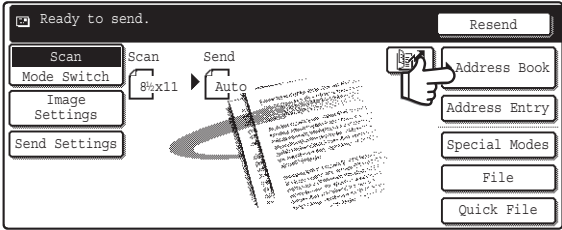

Ready to send. Resend

Scan Scan Send 8x11 Auto

Mode Switch

Image Settings

Send Settings

Address Book

Address Entry

Special Modes

File

Quick File

Touch the [Address Book] key.

**2**

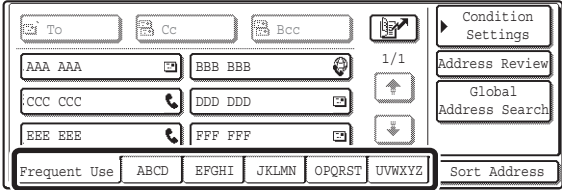

To Cc Bcc

AAA AAA BBB BBB 1/1

CCC CCC DDD DDD

EEE EEE FFF FFF

Frequent Use ABCD EFGHI JKLMN OPQRST UVWXYZ Sort Address

Condition Settings

Address Review

Global Address Search

Touch the index tab where the destination is stored.



It is convenient to store frequently used destinations in the [Frequent Use] index. Specify that a destination be displayed in the [Frequent Use] index when you store the destination.

**3**

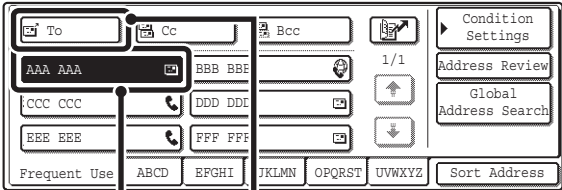

To Cc Bcc

AAA AAA BBB BBB 1/1

CCC CCC DDD DDD

EEE EEE FFF FFF

Frequent Use ABCD EFGHI JKLMN OPQRST UVWXYZ Sort Address

Condition Settings

Address Review

Global Address Search

(1) (2)

Specify the destination.

(1) Touch the one-touch key of the desired destination.

If you select an incorrect destination, touch the key again to cancel the selection.

(2) Touch the [To] key.

This enters the selected destination.



**To continue specifying other destinations...**

It is possible to specify multiple scan mode (Scan to E-mail, Scan to FTP, Scan to Desktop), Internet fax, and fax mode destinations when performing a "broadcast" transmission (maximum of 500 destinations). Repeat steps 2 and 3. When performing Scan to E-mail, you can select a one-touch key and then touch the [Cc] key or the [Bcc] key to send Cc or Bcc copies of the e-mail.



• **System Settings (Administrator): Bcc Setting**

This setting enables or disables Bcc delivery. When enabled, the [Bcc] key appears in the Address Book screen.

• **System Settings (Administrator): Must Input Next Address Key at Broadcast Setting**

This setting determines whether or not the [Next Address] key can be omitted before specifying the next destination. Factory default setting: the [Next Address] key can be omitted.

• **System Settings (Administrator): Disable Switching of Display Order**

This is used to disable switching of the order of display of the one-touch keys in the Address Book screen. The currently selected display order will be the order that is used after this setting is enabled.

# CHECKING AND DELETING THE SELECTED DESTINATIONS

When multiple destinations have been selected, you can display and check the destinations. You can also delete a destination from the list (cancel selection of the destination).

1

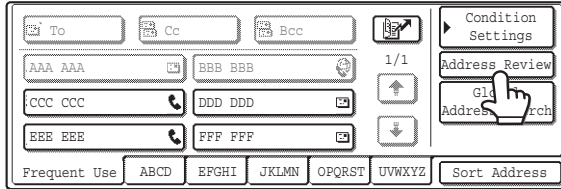

Touch the [Address Review] key.

2

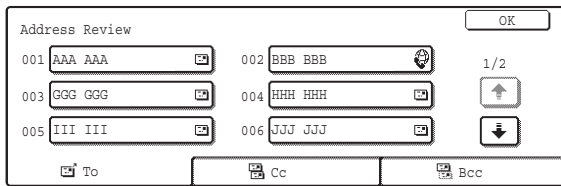

Check the destinations.



To check Cc or Bcc destinations, touch the corresponding tab.



**To cancel a specified destination...**

Touch the one touch-key of the destination that you wish to cancel. A message will appear to confirm the deletion. Touch the [Yes] key.

3

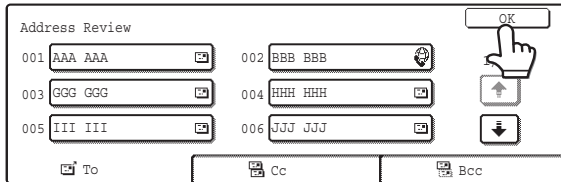

Touch the [OK] key.

You will return to the address review screen.

---

---

# USING A SEARCH NUMBER TO SPECIFY A DESTINATION

A destination stored in the Address Book can be called up using the  key. This can be done in the base screen of any of the modes or in the Address Book screen.

**1**

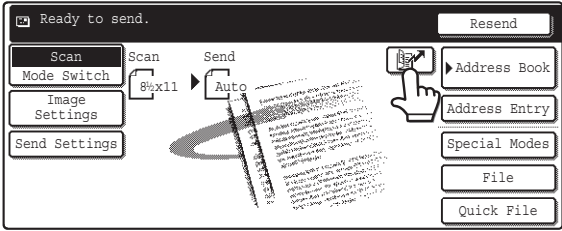



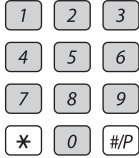

**Touch the  key.**

**2**



**Enter the 3-digit search number of the address with the numeric keys.**

When the 3-digit search number is entered, the stored address is called up and specified as a destination.

- 2**
-  • The search number is the number that was stored when the destination was stored in the address book.
  - If you do not know the search number, print the one-touch address list using "Sending Address List" in the system settings.
  - When entering search numbers such as "001" and "011", "0" can be omitted. For example to enter "001", enter "1" and touch the  key or the [Next Address] key.
-  If an incorrect search number is entered...**
- Press the [CLEAR] key () to clear the number and enter the correct number.

# ENTER THE ADDRESS MANUALLY

Destination addresses for Scan to E-mail and Internet fax can be entered manually.

1

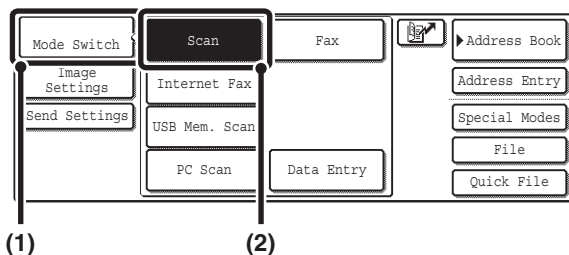

## Change the mode.

- (1) Touch the [Mode Switch] key.
- (2) Touch the key of the mode that you wish to use.

2

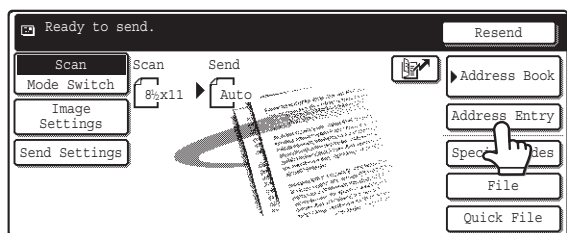

## Touch the [Address Entry] key.

3

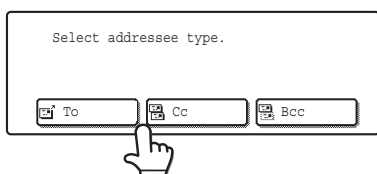

## Enter the destination address.

- (1) If scan mode is selected, select the type of delivery.

Normally the [To] key is touched. This specifies the e-mail address that will be entered as the recipient.

- (2) Enter the destination address on the text entry screen that will appear.

Enter the destination address and touch the [OK] key in the text entry screen.

For the procedure for entering text, see "6. ENTERING TEXT" in the User's Guide.



- If you wish the destination to be a Cc destination, touch the [Cc] key.
- The [Bcc] key only appears when Bcc has been enabled using "Bcc Setting" in the system settings (administrator). If you wish the destination to be a Bcc destination, touch the [Bcc] key.
- When Internet fax mode is selected, you will return to the base screen after entering the destination address; however, if "I-fax Reception Report On/Off Setting" is enabled in the system settings (administrator), the I-fax reception report settings screen will appear. If you wish to receive a report, touch the [Yes] key. If not, touch the [No] key.



### System Settings (Administrator): I-Fax Reception Report On/Off Setting

This setting is used to request a reception report when an Internet fax is sent. When the destination is specified by directly entering the address, a message will appear asking you if you wish to receive a report.

### System Settings (Administrator): Bcc Setting

This setting enables or disables Bcc delivery. When enabled, the [Bcc] key appears in the Address Book screen and the delivery type selection screen.

# CALLING UP A DESTINATION FROM A GLOBAL ADDRESS BOOK

When an LDAP server is configured in the Web page, you can look up an address in a global address book and retrieve the address for Scan to E-mail or Internet fax transmission.

1

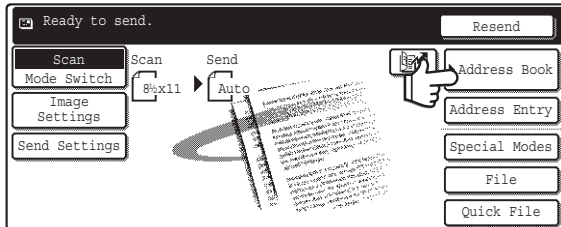

Touch the [Address Book] key.

2

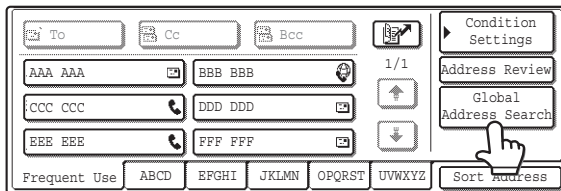

Touch the [Global Address Search] key.



If only one LDAP server is configured, the global address search screen will appear. Go to step 4.

3

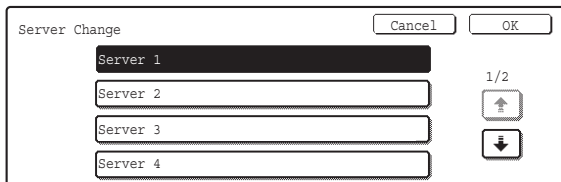

Search for the destination.

**(1) Select the LDAP server.**

Touch the key of the LDAP server that you wish to use and then touch the [OK] key.

**(2) Search for the destination on the text entry screen that will appear.**

Enter the initial letters of the name of the destination and touch the [Search] key in the text entry screen. After a brief interval the results will appear.

For the procedure for entering text, see "6. ENTERING TEXT" in the User's Guide.



**How to search**

Enter the initial letters of the name (maximum of 64 characters). The system will look for names starting with the entered letters.

An asterisk \* can be used as follows:

XXX\*: Names beginning with "XXX".

\*XXX: Names that end with "XXX".

\*XXX\*: Names that include "XXX".

AA\*XX: Names that start with "AA" and end with "XX".

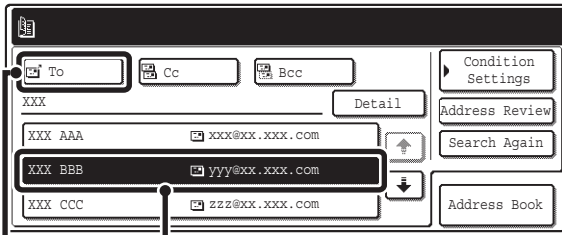

(2)

(1)

## Select the destination.

### (1) Touch the key of the desired destination.

If there are more destinations than can be displayed in the screen, touch the keys to change pages.

### (2) Touch the [To] key.

This enters the selected destination.

If you wish to enter another destination, repeat steps (1) and (2) above.



- If no names are found that match the search letters, a message will appear. Touch the [OK] key to close the message and touch the [Search Again] key to search again.
- If more than 30 matches are found, a message will appear in the screen. Touch the [OK] key to close the message. Up to 300 matches can appear. If no names are found that match the search letters, touch the [Search Again] key to search again using more search letters.
- **To check the information stored in a destination...**
  - (1) Touch the key of the destination that you wish to check.
  - (2) Touch the [Detail] key.
 

The stored information appears.
  - (3) Touch the [OK] key.
 

You will return to the search results screen.
- **If a screen for selecting the address to be used appears...**

If the selected destination includes a fax number, telephone number, or other contact information in addition to the e-mail address or Internet fax address, you will need to select which address you wish to use. Touch the [E-mail] key or the [Internet Fax] key to retrieve the address for Scan to E-mail or Internet fax transmission.
- The [Detail] key can be touched to display information on the selected destination. To store the selected destination in the Address Book, touch the [Register] key.

---

---

# USING THE RESEND FUNCTION

The last 8 destination addresses used for Scan to E-mail and Internet fax transmissions are saved in memory and can be selected to resend to those destinations.

**1**

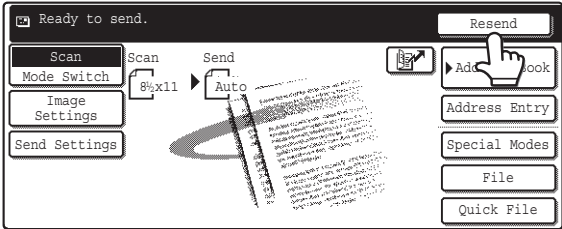

**Touch the [Resend] key.**

**2**

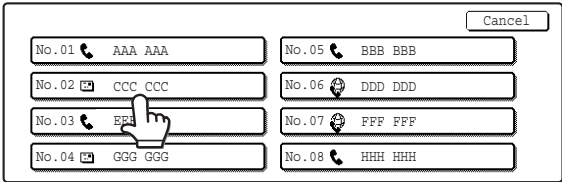

**Touch the key of the desired address.**  
The last 8 addresses used for transmission are displayed.

- 
- When the [Resend] key is touched and a destination selected, the mode of the selected destination is automatically selected.
  - The following types of addresses are not stored for resending.
    - A one-touch key in which multiple destinations are stored (group key).
    - Scan to FTP, Scan to Desktop, and Scan to Network Folder destinations
    - Broadcasting destinations
    - Addresses used only for BCC delivery
    - Destinations transmitted to using a program

# 3

## BASIC PROCEDURE FOR TRANSMISSION IN SCAN MODE

### SCANNING TO E-MAIL, FTP, DESKTOP, AND NETWORK FOLDER



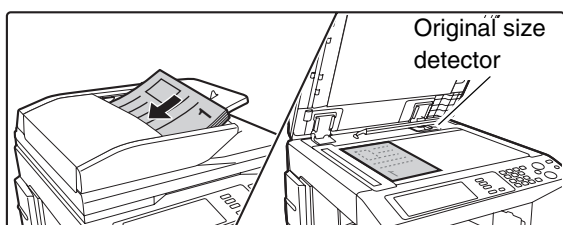

This section explains the basic procedure for transmission in scan mode (Scan to E-mail, Scan to FTP, Scan to Desktop, and Scan to Network Folder).

 When a default address is configured in "Default Address Setting" in the system settings (administrator), the mode cannot be changed, the destination cannot be changed, and destinations cannot be added. If you wish to change the mode or destination, touch the [Cancel] key in the touch panel and then follow the procedure below.



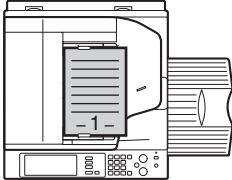
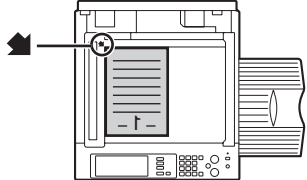

**Place the original.**

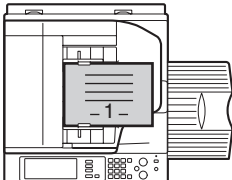
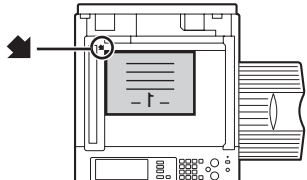
 • When placing the original, orient it as explained below.

Original	Document feeder tray Place the originals face up.	Document glass Place the original face down and align the corner with the tip of the arrow mark  in the top left corner of the document glass scale.
Portrait orientation* 		
Landscape orientation 		

\* To place a large portrait-oriented original, place it as shown above in "Landscape orientation" and specify the placement orientation in step 4.

- Place 5-1/2" x 8-1/2" (A5) size originals in portrait (vertical) orientation ().
- If placed in landscape (horizontal) orientation () , an incorrect size will be detected. For an 5-1/2" x 8-1/2"R (A5R) size original, enter the original size manually.
- Originals cannot be scanned in succession from both the automatic document feeder and the document glass and sent in a single transmission.

 Do not place any objects under the original size detector. Closing the automatic document feeder with an object underneath may damage the original size detector plate and prevent correct detection of the document size.



2

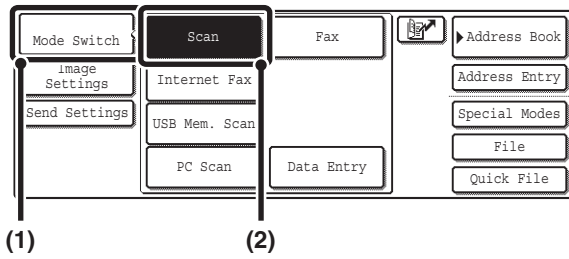

### Change to scan mode.

- (1) Touch the [Mode Switch] key.
- (2) Touch the [Scan] key.

3

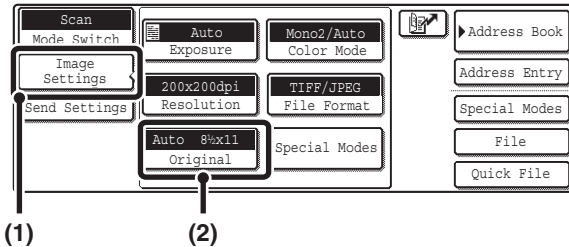

### Display the original settings screen.

- (1) Touch the [Image Settings] key.
- (2) Touch the [Original] key.



The current settings of the [Exposure], [Resolution], [Original], [Color Mode], and [File Format] keys appear in the top half of each key. Touch each key to change the settings.

[CHANGING THE EXPOSURE AND EXPOSURE MODE](#) (page 31), [CHANGING THE RESOLUTION](#) (page 33), [AUTOMATICALLY SCANNING BOTH SIDES OF AN ORIGINAL \(2-Sided Original\)](#) (page 34), [SPECIFYING THE ORIGINAL SCAN SIZE AND SEND SIZE \(Enlarge/Reduce\)](#) (page 35), [CHANGING THE COLOR MODE](#) (page 39), [CHANGING THE FILE FORMAT](#) (page 40), [7. CONVENIENT FUNCTIONS](#) (page 83)

4

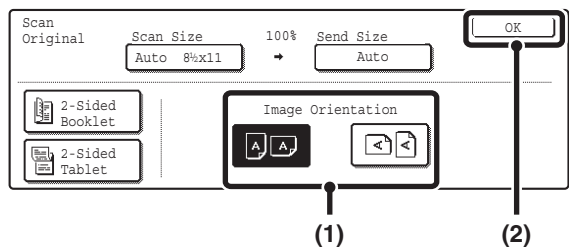

### Specify the orientation in which the original is placed.

To enable the original to be scanned in the correct orientation (the orientation of the top edge of the original that is shown at the top of the display), specify the orientation in which the original was placed in step 1.

- (1) Touch the appropriate orientation key.

If the top edge of the original is up, touch the key. If the top edge of the original is to the left, touch the key.

- (2) Touch the [OK] key.

You will return to the screen of step 3. Touch the [Image Settings] key to close the menu.



The original orientation is initially set to . If the original was placed with the top edge up, this step is not necessary.

5

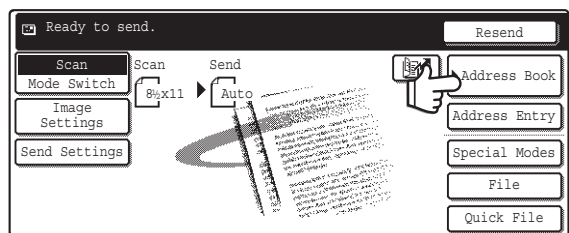



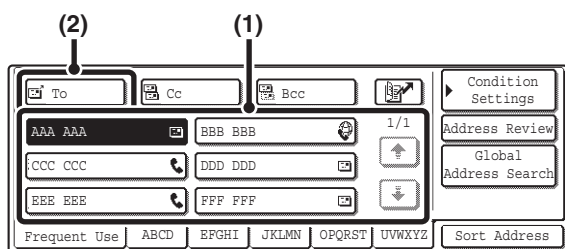

### Touch the [Address Book] key.



## Specify the destination.

### (1) Touch the one-touch key of the desired destination.

The icon on the key indicates the type of destination stored in the key.

-  : Scan to E-mail
-  : Scan to FTP
-  : Scan to Network Folder
-  : Scan to Desktop

### (2) Touch the [To] key.

The destination is specified.

## 6



- After a one-touch key is touched, if the screen is changed without touching the [To] key, the destination is automatically specified.
- When performing Scan to E-mail, you can also send Cc or Bcc copies to other destinations. Touch the desired destination and then touch the [Cc] key or the [Bcc] key.
- Multiple destinations can be specified. To specify multiple destinations, repeat steps (1) and (2). Note that multiple destinations cannot be specified when a Scan to Network Folder destination is specified.
- You can also select multiple one-touch keys and then touch the [To] key (or the [Cc] or [Bcc] key) to enter all of the selected keys as destinations at once.
- In addition to selecting a one-touch key, a destination can also be specified by entering a search number. For a Scan to E-mail destination, it is possible to enter a destination manually or retrieve it from a global address book. For more information, see "2. ENTERING DESTINATIONS" (page 19).



#### System Settings (Administrator): Bcc Setting

This setting enables or disables Bcc delivery. When enabled, the [Bcc] key appears in the Address Book screen.

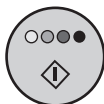

or



## Press the [COLOR START] key (○●●●) or the [BLACK & WHITE START] key (○●).

Scanning begins.

- If the original is placed on the document glass, the [Read-End] key appears in the touch panel. To scan only one original, go to step 9. To scan multiple originals, go to the next step.
- If the original was inserted in the document feeder tray, a beep will sound when scanning is completed and transmission will take place.

## 7



- To scan in full color, press the [COLOR START] key (○●●●). To scan in black and white, press the [BLACK & WHITE START] key (○●). If the color mode of the [COLOR START] key (○●●●) is set to [Auto], the color of the original will be detected automatically and scanning in full color, grayscale or Mono 2 will take place.
- If the file type is [Encrypt PDF], a password entry screen will appear when the [START] key is pressed.

Please enter encrypt PDF password.

Touch the [Entry] key to open the keyboard screen, enter a password (maximum of 32 characters), and touch the [OK] key. The recipient must use the password entered here to open the encrypted PDF file.

To cancel encrypted PDF, touch the [Cancel] key. The format settings screen will appear to let you change the file type. Select a new file type and press the [START] key to begin transmission.

8

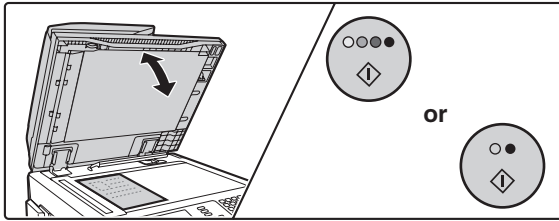

If the original was placed on the document glass, replace it with the next original and press the [COLOR START] key (●●●●) or the [BLACK & WHITE START] key (●●).

Repeat until all originals have been scanned.



The exposure, resolution, and scan size/send size can be changed for each original page that is scanned.

9

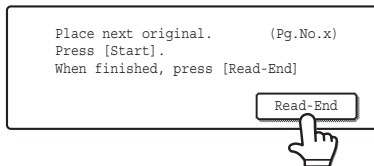

**Touch the [Read-End] key.**

A beep will sound to indicate that the operation is completed. Open the automatic document feeder and remove the original.



If no action is taken for one minute after the confirmation screen appears, scanning automatically ends and the transmission is reserved.



- When all originals have been scanned, "Job stored." will be displayed together with a job control number. This number can be used to locate the job in the Transaction Report or in the Image Sending Activity Report. If the job is a broadcast transmission, this number will also appear in the key of the job in the job status screen. For this reason, making a note of the number is useful for checking the result.
- If the memory becomes full while the originals are being scanned, a message will appear and scanning will stop.
- When performing Scan to E-mail, take care not to send a file that is too large. In particular, multi-page files tend to be large. When sending a multi-page file or other large file, it may be necessary to reduce the number of scanned pages or reduce the send size.
- **Storing a mail signature**  
You can have preset text automatically added at the end of e-mail messages as a mail signature. This is convenient when you wish to have a corporate policy or other preset text appear at the bottom of e-mail messages. To store the text for the mail signature, click [Application Settings] and then [Network Scanner Settings] in the Web page menu. (Administrator rights are required.) Up to 900 characters can be entered. (The mail signature is not included in the maximum number of characters that can be entered in the e-mail message.)  
Use "Pre-Setting Mail Signature" in the system settings (administrator) to specify whether or not a mail signature is added.



#### To cancel scanning...

Press the [STOP] key (⊘) to cancel the operation.



#### • System Settings (Administrator): Scan Settings

Scanner transmission settings can be configured, including the default resolution and exposure settings, the default color mode and file format, the file compression method for broadcasting, the file size limit for Scan to E-mail, and the default sender and destination.

#### • System Settings (Administrator): Pre-Setting Mail Signature

Use this setting to specify whether or not a mail signature is added at the end of e-mail messages. By factory default, a mail signature is not added.

# CHANGING THE EXPOSURE AND EXPOSURE MODE

The exposure can be changed to match the darkness of the original. The exposure mode can be changed to match the original type.

1

**Display the exposure setting screen.**

- (1) Touch the [Image Settings] key.
- (2) Touch the [Exposure] key.

2

**Read the displayed message and touch the [OK] key.**

---

If a broadcast transmission is performed that includes both scan mode destinations and Internet fax destinations, the exposure settings for Internet fax mode will have priority.

3

**Select the exposure and exposure mode.**

- (1) Touch the [Manual] key.
- (2) Adjust the exposure with the keys.  
When the exposure is set to [Auto], the keys cannot be used.  
The exposure darkens when the key is touched, and lightens when the key is touched.  
To return to auto exposure adjustment, touch the [Auto] key.
- (3) Select the exposure mode.  
Touch the original type key that matches the original type.
- (4) Touch the [OK] key.

---

- When the exposure is set to [Auto], the exposure modes [Photo], [Printed Photo], and [Map] do not appear.
- To reduce the moiré effect when scanning printed matter, touch the [Moiré Reduction] checkbox so that a checkmark  appears.

When using the document glass to scan multiple original pages, the exposure setting can be changed each time you change pages. When using the automatic document feeder, the exposure setting cannot be changed once scanning has begun. (However, when the special mode "Job Build" is used, the exposure can be changed each time a new set of originals is inserted.)

**System Settings (Administrator): Default Exposure Settings**  
This is used to change the default exposure setting.

## How to select the exposure

Exposure		When to select
Auto		This setting automatically adjusts the exposure for light and dark parts of the original.
Manual	1 to 2	Select this setting when the original consists of dark text.
	3	Select this setting for a normal original (neither dark nor light).
	4 to 5	Select this setting when the original consists mostly of faint text.

## How to select the exposure mode

Setting	Description
Text/Prt. Photo	This mode provides the best balance for scanning an original which contains both text and printed photographs, such as a magazine or catalogue.
Text/Photo	This mode provides the best balance for scanning an original which contains both text and photographs, such as a text document with a photo pasted on.
Text	Use this mode for regular text documents.
Photo	Use this mode to scan photos.
Printed Photo	This mode is best for scanning printed photographs, such as photos in a magazine or catalogue.
Map	This mode is best for scanning the color shading and fine details found on most maps.

# CHANGING THE RESOLUTION

The resolution setting can be selected.

**1**

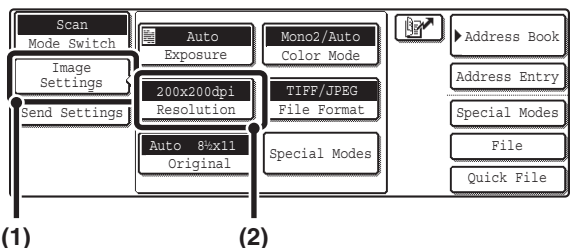

**Display the resolution setting screen.**

- (1) Touch the [Image Settings] key.
- (2) Touch the [Resolution] key.

**2**

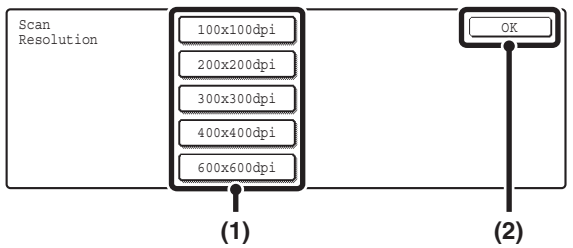



**Select the resolution.**

- (1) Touch the key of the desired resolution.
- (2) Touch the [OK] key.

## How to select the resolution

When scanning a regular text document, a resolution setting of 200x200dpi will create a sufficiently legible image. When scanning a photo or illustration, a high resolution setting (such as 600x600dpi) will produce a sharp and clear image. However, a high resolution setting will result in a large file, and if the file is too large, transmission may not be possible. In this event, reduce the size of the image file (for example, by reducing the number of scanned pages).

 When using the automatic document feeder, the resolution setting cannot be changed once scanning has begun. However, when the document glass or the "Job Build" special mode is used, the resolution can be changed each time a new original or set of originals is placed.

 **System Settings (Administrator): Initial Resolution Setting**  
This is used to change the default resolution setting.

# AUTOMATICALLY SCANNING BOTH SIDES OF AN ORIGINAL (2-Sided Original)

The automatic document feeder can be used to automatically scan both sides of an original.

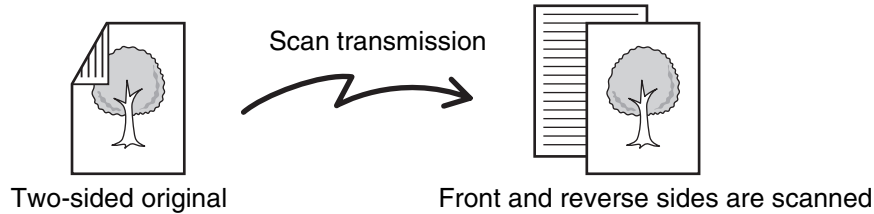

1

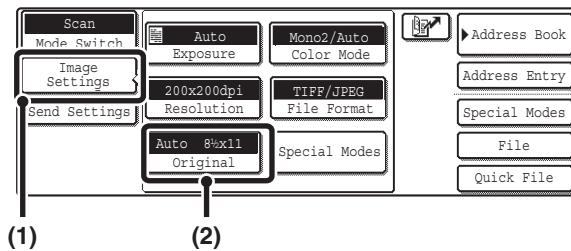

Display the original settings screen.

- (1) Touch the [Image Settings] key.
- (2) Touch the [Original] key.

2

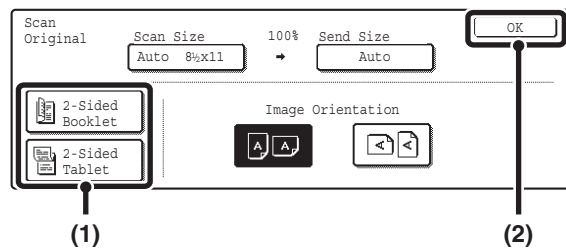

Specify whether the binding style of the two-sided original is book style or tablet style.

- (1) Touch the [2-Sided Booklet] key or the [2-Sided Tablet] key.

A book and a tablet are bound as shown below.

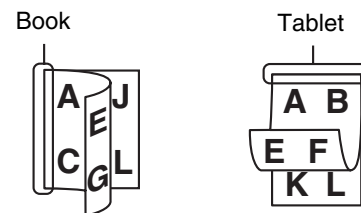

- (2) Touch the [OK] key.

 To cancel two-sided scanning, touch the highlighted key so that it is no longer highlighted.



Two-sided scanning automatically turns off after scanning and transmission are finished.

---

---

# SPECIFYING THE ORIGINAL SCAN SIZE AND SEND SIZE (Enlarge/Reduce)

When the original is placed, its size is automatically detected and displayed in the base screen. The size of the placed original is indicated as the scan size, and the size to be transmitted is indicated as the send size.

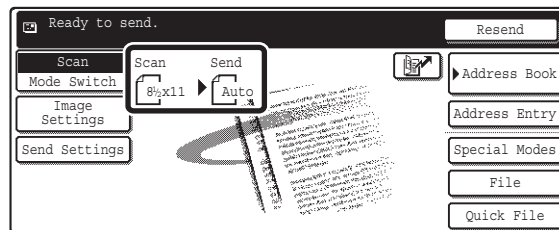

In the above screen, the scan size (the placed original) is 8-1/2" x 11" (A4) and the send size is auto. For example, if the scan size is 8-1/2" x 11" (A4) and the send size is 5-1/2" x 8-1/2" (B5), the image will be reduced before transmission.

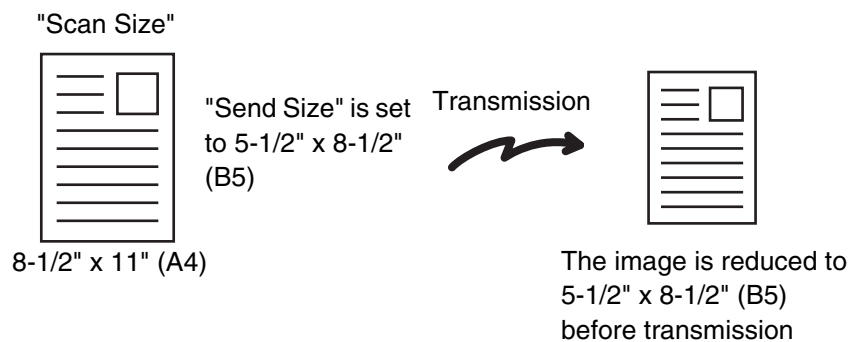

- Only standard original sizes can be automatically detected.
- If the original is a non-standard size, you must set the scan size manually.



# SPECIFYING THE SCAN SIZE OF THE ORIGINAL

If the original is a non-standard size or you wish to change the scan size, touch the [Original] key to specify the original size manually. Place the original in the document feeder tray or on the document glass and follow the steps below.

## Specifying the size using paper sizes

**1**

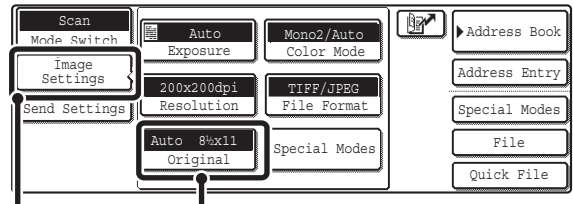

**Display the original settings screen.**

- Touch the [Image Settings] key.
- Touch the [Original] key.

The automatically detected size appears at the top of the [Original] key.

**2**

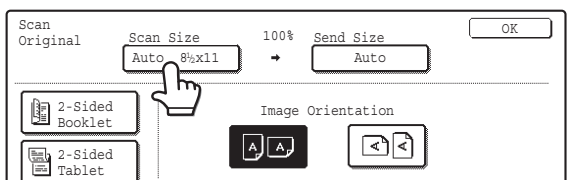

**Touch the [Scan Size] key.**

**3**

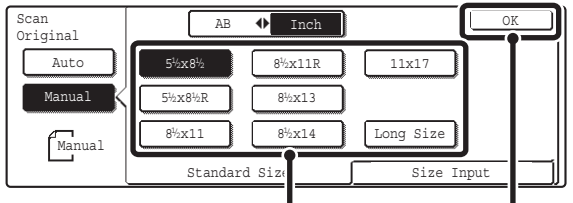

**Specify the scan size.**

- Touch the appropriate original size key.
- Touch the [OK] key.



- If you are sending a long original, touch the [Long Size] key. Use the automatic document feeder to scan a long original. (When the automatic document feeder is not installed, the [Long Size] key does not appear.) The maximum length that can be scanned is 31-1/2" (800 mm) (the maximum width is 11-5/8" (297 mm)).
- To specify an AB size for the scan size, touch the [AB ◀▶ Inch] key to highlight the [AB] side and then specify the scan size.

**4**

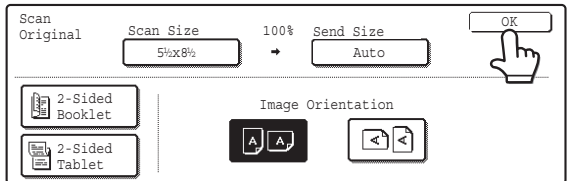

**Touch the [OK] key.**



When [Long Size] is selected, the two-sided scanning setting and send size cannot be changed. In addition, scanning will take place in Mono 2 mode.

# Specifying the size by entering numerical values.

When scanning a non-standard size original such as a postcard or card, follow these steps to specify the original size. The width can be from 2-1/2" to 17" (64 mm to 432 mm), and the length can be from 2-1/2" to 11-5/8" (64 mm to 297 mm).

**1**

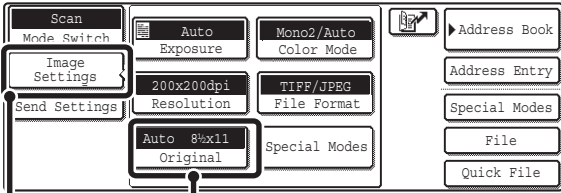

**Display the original settings screen.**

- (1) Touch the [Image Settings] key.
- (2) Touch the [Original] key.

The automatically detected size appears at the top of the [Original] key.

**2**

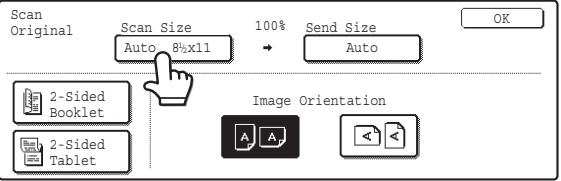

**Touch the [Scan Size] key.**

**3**

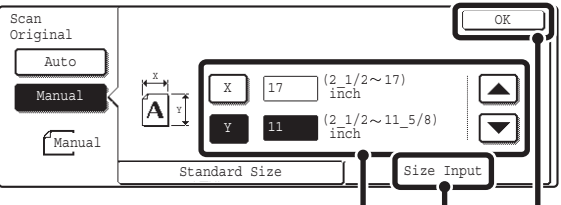

**Enter the scan size (original size).**

- (1) Touch the [Size Input] tab.
- (2) Touch the [X] key and enter the X (horizontal) dimension with the  $\downarrow$   $\uparrow$  keys.
- (3) Touch the [Y] key and enter the Y (vertical) dimension with the  $\downarrow$   $\uparrow$  keys.
- (4) Touch the [OK] key.

 **System Settings (Administrator): Original Size Detector Setting**  
This is used to set the size entry screen to "inch units" or "mm units".

**4**

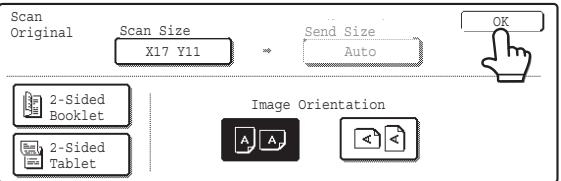

**Touch the [OK] key.**

The specified size appears in the [Scan Size] key.

 • When the scan size is specified by numerical values, the send size cannot be specified.

• When the automatic document feeder is used, an original longer than 17" (432 mm) can be scanned (maximum length 31-1/2" (800 mm)). To scan a long original, touch the [Standard Size] tab in the screen of step 3 and then touch the [Long Size] key.

 [Specifying the size using paper sizes](#) (page 36)

# SPECIFYING THE SEND SIZE OF THE ORIGINAL

Specify the send size as a paper size. If a send size bigger than the scan size is selected, the image will be enlarged. If a send size smaller than the scan size is selected, the image will be reduced.

 The send size cannot be specified when [Long Size] is selected for the scan size, or when the scan size is specified by numerical values.

1

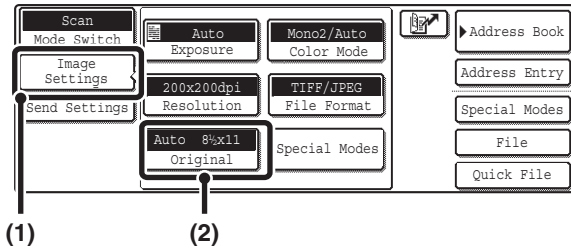

**Display the original settings screen.**

- (1) Touch the [Image Settings] key.
- (2) Touch the [Original] key.

2

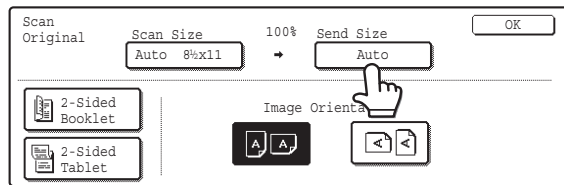

**Touch the [Send Size] key.**

3

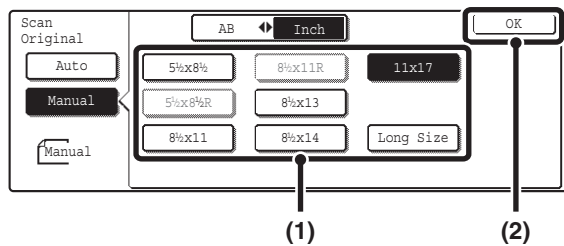

**Specify the send size.**

- (1) Touch the desired send size key.
- (2) Touch the [OK] key.

-  • Size keys that cannot be specified for the send size are grayed out to prevent selection.
- To specify an AB size for the send size, touch the [AB ◀▶ Inch] key to highlight the [AB] side and then specify the send size.

4

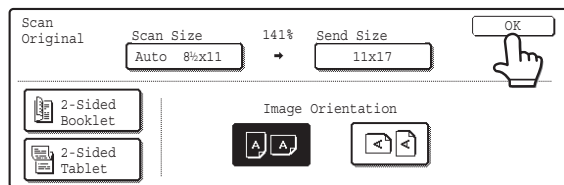

**Touch the [OK] key.**

The ratio used for reduction or enlargement of the original will appear between the "Scan Size" and the "Send Size".

# CHANGING THE COLOR MODE

This procedure is used to change the color mode used to scan the original when the [COLOR START] key (○●●●) or the [BLACK & WHITE START] key (○●) is pressed.

Start key	Mode	Scanning method
[COLOR START] key	Auto	The machine detects whether the original is color or black and white and automatically selects full color or black and white (Mono 2 or Grayscale) scanning.
	Full Color	The original is scanned in full color. This mode is best for full color originals such as catalogues.
[BLACK & WHITE START] key	Mono2	Colors in the original are scanned as black or white. This mode is best for text-only originals.
	Grayscale	The colors in the original are scanned in black and white as shades of gray (grayscale).

1

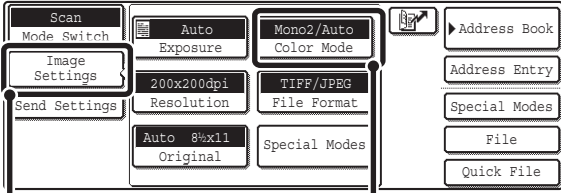

**Display the color mode screen.**

- (1) Touch the [Image Settings] key.
- (2) Touch the [Color Mode] key.

2

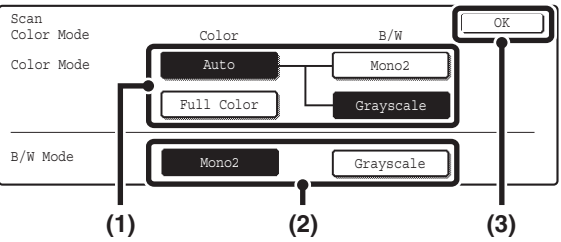

**Select the color mode.**

- (1) Touch the key of the mode to be used when the [COLOR START] key (○●●●) is pressed.
- (2) Touch the key of the mode to be used when the [BLACK & WHITE START] key (○●) is pressed.
- (3) Touch the [OK] key.

You can select whether black & white scanning will take place in Mono 2 or grayscale when [Auto] is selected and a black and white original is scanned. Note that if the file format is set to JPEG, scanning will take place in grayscale.

- 
**System Settings (Administrator): Default Color Mode Settings**  
 The default color mode can be changed.
- System Settings (Administrator): Disable Change of B/W Setting in Auto Mode**  
 This prohibits selection of the black and white original scanning setting when [Auto] is selected for the color mode.

# CHANGING THE FILE FORMAT

The file format (file type and compression method / compression ratio) for sending a scanned image is specified when the destination is stored in a one-touch key; however, you can change the format at the time of transmission. In addition, if the scanned originals are divided into separate files, the number of pages per file can be changed.

1

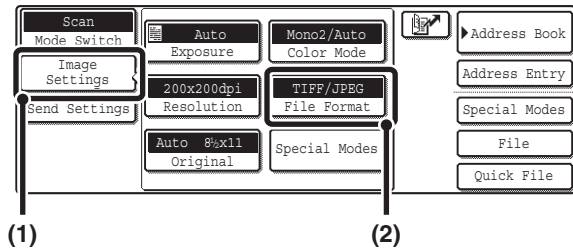

Display the format setting screen.

- (1) Touch the [Image Settings] key.
- (2) Touch the [File Format] key.

2

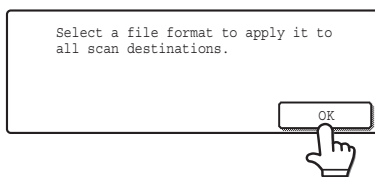

Read the displayed message and touch the [OK] key.

Set the format.

## ● Scanning in Mono 2

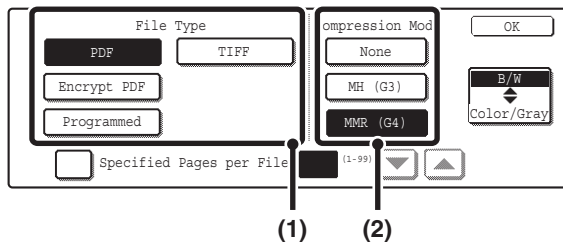

- (1) Select the file type.
- (2) Select the compression mode.

3

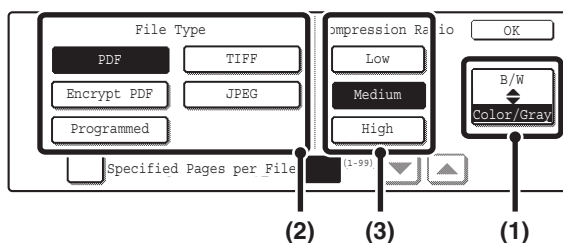

## ● Scanning in color/grayscale

- (1) Touch the indicated key to select [Color/Gray] mode.

When [Color/Gray] is highlighted, [Color/Gray] mode is selected.

- (2) Select the file type.
- (3) Select the compression ratio.

High compression results in a smaller file size, however, the image quality is slightly degraded.



- When this screen is displayed, the setting screen of [B/W] mode initially appears.
- The format set for [B/W] mode will be the file format that is used when the [BLACK & WHITE START] key (○●) is pressed with the B/W Mode set to [Mono2].
- The format set for [Color/Gray] mode will be the file format that is used when the [COLOR START] key (○●●●) is pressed, or when the [BLACK & WHITE START] key (○●) is pressed with the B/W Mode set to [Grayscale].
- The file type of [B/W] mode and the file type of [Color/Gray] mode are linked. The file type cannot be set separately for each. (When [JPEG] is selected for [Color/Gray] mode, [TIFF] is automatically selected for [B/W] mode.)

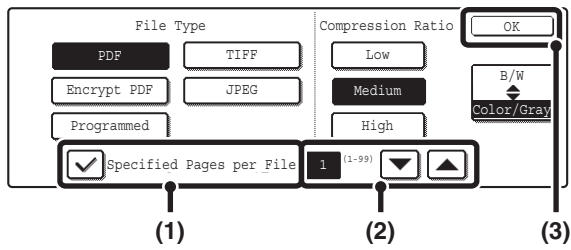

To change the number of pages per file, enter the number of pages and exit the format settings.

- (1) Touch the [Specified Pages per File] checkbox so that a checkmark  appears.
- (2) Set the number of pages per file with the   keys.
- (3) Touch the [OK] key.



- When a checkmark does not appear in the [Specified Pages per File] checkbox , one file is created for all scanned pages.
- When [Specified Pages per File] is selected, consecutive numbers are added to the created file names.
- When [JPEG] is selected for the file type, one file is created for each page (a file cannot be created for multiple pages). For this reason, the [Specified Pages per File] checkbox does not appear.



When [Encrypt PDF] is selected, a password entry screen will appear when the [START] key is pressed to begin scanning and transmission.  
Touch the [Entry] key in the displayed screen to open the keyboard screen. Enter a password (maximum of 32 characters) and touch the [OK] key. Scanning and transmission will begin.



**System Settings (Administrator): Initial File Format Setting**  
This sets the default file format setting for scanner transmission.

# CHANGING THE SUBJECT, FILE NAME, REPLY-TO, AND MESSAGE

The subject, file name, reply-to, and message can be changed when performing a scan transmission. Preset items can be selected or text can be directly entered.

- When performing Scan to FTP, Scan to Desktop, or Scan to Network Folder, only the file name is used.
- If the subject and file name are not changed, the settings in the Web page are used.
- If the sender name is not changed, the name set in "Default Sender Set" in the system settings is used. If this is not configured, the administrator name in the Web pages is used.
- Selections for the subject, file name, and message are configured by clicking [Application Settings] and then [Network Scanner Settings] in the Web page menu. (Administrator rights are required.)
- For the procedure for entering text, see "6. ENTERING TEXT" in the User's Guide.

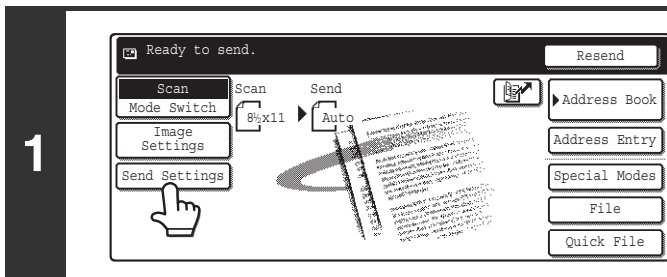

## Touch the [Send Settings] key.

If you are sending to a Scan to FTP, Scan to Desktop, or Scan to Network Folder destination, go to step 4.

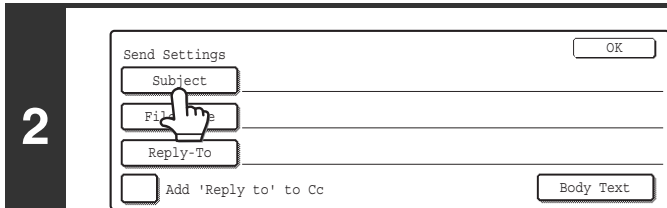

## To change the subject, touch the [Subject] key.

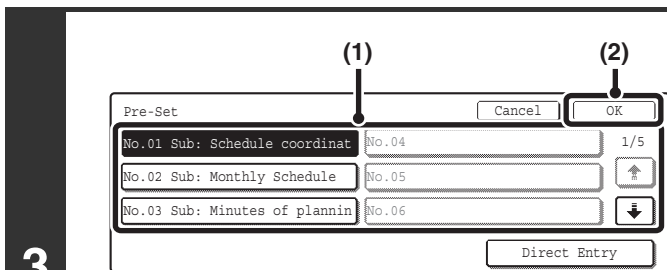

## Enter the subject.

- (1) Touch a Pre-Set text key.
- (2) Touch the [OK] key.

- If you wish to directly enter the text, touch the [Direct Entry] key to open the text entry screen. Enter the text and touch the [OK] key. Up to 54 characters can be entered.
- The text in a pre-set text key can be edited by touching the pre-set text key and then the [Direct Entry] key. The text entry screen will appear with the selected pre-set text entered. (When a destination is stored using the Web page, up to 80 characters can be entered. However, only 54 characters will appear and can be edited in the touch panel.)

4

To change the file name, touch the [File Name] key.

- The file name is entered in the same way as the subject.
- If you are sending to a Scan to FTP, Scan to Desktop, or Scan to Network Folder destination, go to step 9.



Up to 54 characters can be entered for the file name.

5

To change "Reply-To", touch the [Reply-To] key.



If user authentication is being used, the information of the user that logged in will be applied, and thus "Reply-To" cannot be changed.

6

Specify a user for "Reply-To" and touch the [OK] key.

- Touch the key that you wish to use for "Reply-To".
- You can also touch the [Global Address Search] key to specify a user stored in a global address book for "Reply-To". You can also touch the [Address Entry] key to directly enter an e-mail address.



To specify the return address, touch the  key and enter one of the user numbers that have been previously stored using "User Registration" in the system settings (administrator).

7

To change the message, touch the [Body Text] key.



8

## Enter the message and touch the [OK] key.

- To select a pre-set message previously stored in the Web page, touch the [Pre-Set Select] key.
- To directly enter the message, touch the [Edit] key.



- 1800 characters can be entered. (A line break counts as one character.)
- To clear the entered text, touch the [Clear All] key.
- Each line of the entered text can be selected with the keys. To edit the selected line, touch the [Edit] key. The text entry screen will appear with the selected text entered.

9

## Touch the [OK] key.



- The [Add 'Reply to' to Cc] checkbox can be selected  to send a Cc copy to the sender.



When storing pre-set text for the subject and file name in the Web page, up to 80 characters can be entered.



- **System Settings (Administrator): The Number of File Name/Subject/Body Keys Displayed Setting**  
This is used to select the number of subjects and file names displayed in one screen (3 or 6).
- **System Settings: Default Sender Set**  
This is used to store the sender name and e-mail address that is used when a sender is not selected.

# 4

## BASIC PROCEDURE FOR SCANNING IN USB MEMORY MODE

### SCANNING TO USB MEMORY

Follow the steps below to send a scanned file to a commercially available USB memory device that has been connected to the machine. This stores the file in the USB device.



- Consult your dealer or retailer for USB memory devices that can be used.
- When a default address is configured in "Default Address Setting" in the system settings (administrator), the mode cannot be changed. To switch to USB memory mode, touch the [Cancel] key in the touch panel and then follow the steps below.

1

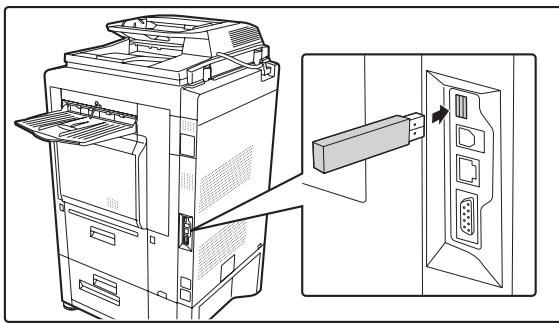

**Connect the USB memory to the USB connector (Type A) on the machine.**





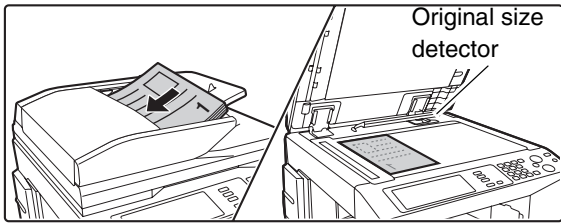

#### **System Settings: USB-Device Check**

This is used to check the connection of a USB device to the machine.



## Place the original.

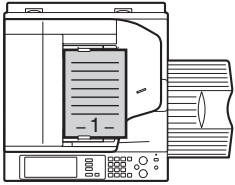
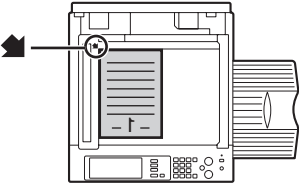

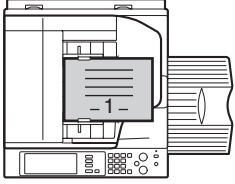
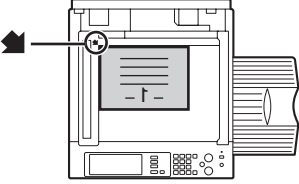
- When placing the original, orient it as explained below.

Original	Document feeder tray Place the originals face up.	Document glass Place the original face down and align the corner with the tip of the arrow mark  in the top left corner of the document glass scale.
Portrait orientation* 		
Landscape orientation 		

\* To place a large portrait-oriented original, place it as shown above in "Landscape orientation" and specify the placement orientation in step 5.

- Place 5-1/2" x 8-1/2" (A5) size originals in portrait (vertical) orientation (  ).  
If placed in landscape (horizontal) orientation (  ), an incorrect size will be detected. For an 5-1/2" x 8-1/2"R (A5R) size original, enter the original size manually.
- Originals cannot be scanned in succession from both the automatic document feeder and the document glass and sent in a single transmission.



Do not place any objects under the original size detector. Closing the automatic document feeder with an object underneath may damage the original size detector plate and prevent correct detection of the document size.

2

## Change to USB memory mode.

- (1) Touch the [Mode Switch] key.
- (2) Touch the [USB Mem. Scan] key

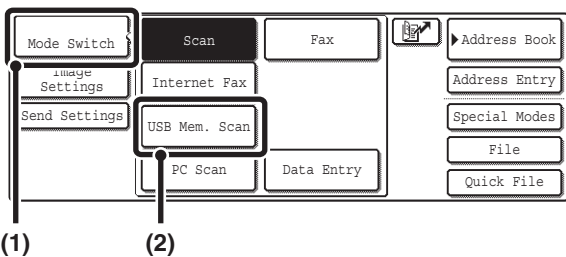

3



- When scanning to USB memory, there is no need to specify the destination.
- If a destination of another mode has been previously specified, a message will appear when you change to USB memory mode indicating that the destination setting will be cleared. Touch the [OK] key in the message screen and go to the next step.

4

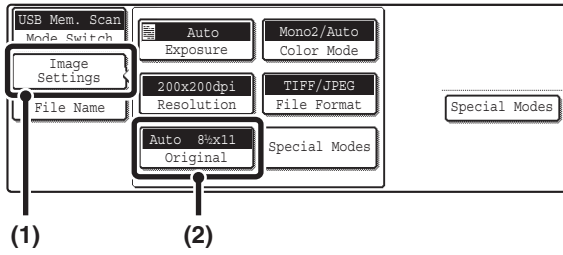

### Display the original settings screen.

- (1) Touch the [Image Settings] key.
- (2) Touch the [Original] key.



The current settings of the [Exposure], [Resolution], [Original], [Color Mode], and [File Format] keys appear in the top half of each key. Touch each key to change the settings.

[CHANGING THE EXPOSURE AND EXPOSURE MODE](#) (page 50), [CHANGING THE RESOLUTION](#) (page 52), [AUTOMATICALLY SCANNING BOTH SIDES OF AN ORIGINAL \(2-Sided Original\)](#) (page 53), [SPECIFYING THE ORIGINAL SCAN SIZE AND SEND SIZE \(Enlarge/Reduce\)](#) (page 54), [CHANGING THE COLOR MODE](#) (page 58), [CHANGING THE FILE FORMAT](#) (page 59), [7. CONVENIENT FUNCTIONS](#) (page 83)

5

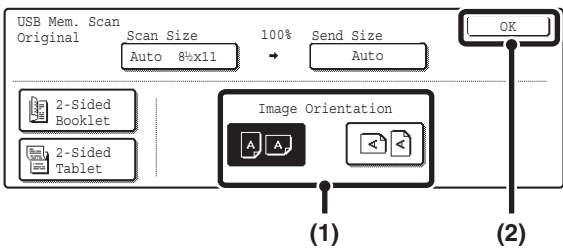

### Specify the orientation in which the original is placed.

To enable the original to be scanned in the correct orientation (the orientation of the top edge of the original that is shown at the top of the display), specify the orientation in which the original was placed in step 2.

- (1) Touch the appropriate orientation key.

If the top edge of the original is up, touch the key. If the top edge of the original is to the left, touch the key.

- (2) Touch the [OK] key.

You will return to the screen of step 4. Touch the [Image Settings] key to close the menu.



The original orientation is initially set to . If the original was placed with the top edge up, this step is not necessary.



or



**Press the [COLOR START] key (○●●●) or the [BLACK & WHITE START] key (○●).**

Scanning begins.

- If the original is placed on the document glass, the [Read-End] key appears in the touch panel. To scan only one original, go to step 8. To scan multiple originals, go to the next step.
- If the original was inserted in the document feeder tray, a beep will sound when scanning is completed and transmission will begin. Go to step 9.

**6**  Do not disconnect the USB memory until "Sending data has been completed." appears in the touch panel.

-  To scan in full color, press the [COLOR START] key (○●●●). To scan in black and white, press the [BLACK & WHITE START] key (○●). If the color mode of the [COLOR START] key (○●●●) is set to [Auto], the color of the original will be detected automatically and scanning in full color, grayscale or Mono 2 will take place.
- If the file type is [Encrypt PDF], a password entry screen will appear when the [START] key is pressed.

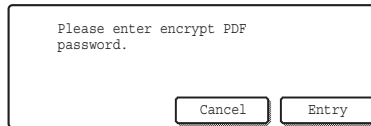

Touch the [Entry] key to open the keyboard screen, enter a password (maximum of 32 characters), and touch the [OK] key. The recipient must use the password entered here to open the encrypted PDF file.

To cancel encrypted PDF, touch the [Cancel] key. The format settings screen will appear to let you change the file type. Select a new file type and press the [START] key to begin transmission.

**7** 

**If the original was placed on the document glass, replace it with the next original and press the [COLOR START] key (○●●●) or the [BLACK & WHITE START] key (○●).**

Repeat until all originals have been scanned.

-  The exposure, resolution, and scan size/send size can be changed for each original page that is scanned.

**8** 

**Touch the [Read-End] key.**

A beep will sound to indicate that the operation is completed. Open the automatic document feeder and remove the original.

-  If no action is taken for one minute after the confirmation screen appears, scanning automatically ends and the transmission is reserved.

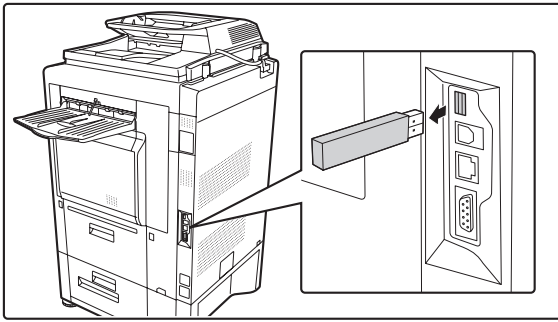

**When "Sending data has been completed." appears in the touch panel, disconnect the USB memory.**



Do not disconnect the USB memory while "Processing data." or "Sending data." appear in the touch panel.



- When transmission to USB memory is completed, "Sending data has been completed." is displayed. After a brief interval the message is cleared and the base screen of image send mode reappears. (The base screen of image send mode is the screen that appears when the [IMAGE SEND] key on the operation panel is pressed.)
- **If the USB memory becomes full during scanning...**  
If JPEG is selected for the file format or the "Specified Pages per File" checkbox is selected, a message will appear and scanning will stop. In this case, only the pages that were completely scanned will be stored in the USB device (except when multiple pages per file are specified).



- **To cancel scanning...**  
Press the [STOP] key (⏹) to cancel the operation.
- **To cancel scanning to USB memory...**  
While scan data is being stored in the USB memory, the message "Sending data." and the [Cancel] key appear in the touch panel. To cancel the storing operation, touch the [Cancel] key.



- **System Settings (Administrator): Scan Settings**  
This is used to set the default color mode and file format.
- **System Settings (Administrator): Disable Scan Function**  
The use of PC scan mode and USB memory mode can be prohibited.

# CHANGING THE EXPOSURE AND EXPOSURE MODE

The exposure can be changed to match the darkness of the original. The exposure mode can be changed to match the original type.

1

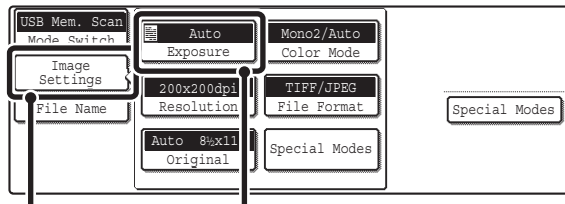





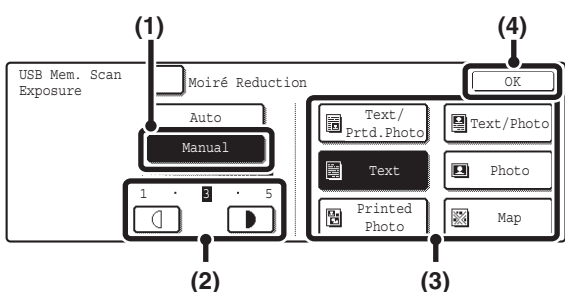

**Display the exposure setting screen.**

- (1) Touch the [Image Settings] key.
- (2) Touch the [Exposure] key.

2



**Select the exposure and exposure mode.**

- (1) Touch the [Manual] key.
- (2) Adjust the exposure with the   keys.  
When the exposure is set to [Auto], the   keys cannot be used.  
The exposure darkens when the  key is touched, and lightens when the  key is touched.  
To return to auto exposure adjustment, touch the [Auto] key.
- (3) Select the exposure mode.  
Touch the original type key that matches the original type.
- (4) Touch the [OK] key.



- When the exposure is set to [Auto], the exposure modes [Photo], [Printed Photo], and [Map] do not appear.
- To reduce the moiré effect when scanning printed matter, touch the [Moiré Reduction] checkbox so that a checkmark  appears.



When using the document glass to scan multiple original pages, the exposure setting can be changed each time you change pages. When using the automatic document feeder, the exposure setting cannot be changed once scanning has begun. (However, when the special mode "Job Build" is used, the exposure can be changed each time a new set of originals is inserted.)



### System Settings (Administrator): Default Exposure Settings

This is used to change the default exposure setting.

## How to select the exposure

Exposure		When to select
Auto		This setting automatically adjusts the exposure for light and dark parts of the original.
Manual	1 to 2	Select this setting when the original consists of dark text.
	3	Select this setting for a normal original (neither dark nor light).
	4 to 5	Select this setting when the original consists mostly of faint text.

## How to select the exposure mode

Setting	Description
Text/Prt. Photo	This mode provides the best balance for scanning an original which contains both text and printed photographs, such as a magazine or catalogue.
Text/Photo	This mode provides the best balance for scanning an original which contains both text and photographs, such as a text document with a photo pasted on.
Text	Use this mode for regular text documents.
Photo	Use this mode to scan photos.
Printed Photo	This mode is best for scanning printed photographs, such as photos in a magazine or catalogue.
Map	This mode is best for scanning the color shading and fine details found on most maps.



# CHANGING THE RESOLUTION

The resolution setting can be selected.

**1**

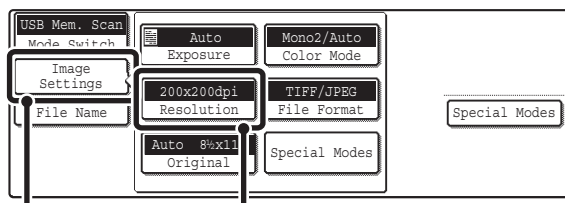

The screenshot shows the 'USB Mem. Scan' menu. The 'Image Settings' option is highlighted with a box and a line pointing to the number (1). The 'Resolution' option is also highlighted with a box and a line pointing to the number (2). Other options visible include 'Auto Exposure', 'Mono2/Auto Color Mode', 'TIFP/JPEG File Format', 'Special Modes', and 'Auto 8x11 Original'.

**Display the resolution setting screen.**

- (1) Touch the [Image Settings] key.
- (2) Touch the [Resolution] key.

**2**

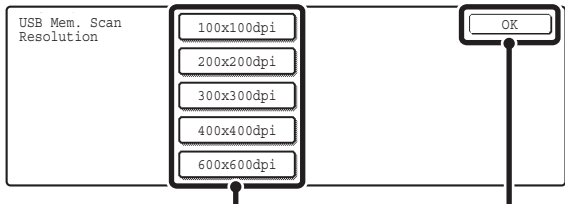

The screenshot shows the 'USB Mem. Scan Resolution' menu. A list of resolution options is shown: '100x100dpi', '200x200dpi', '300x300dpi', '400x400dpi', and '600x600dpi'. The '200x200dpi' option is highlighted with a box and a line pointing to the number (1). An 'OK' key is also highlighted with a box and a line pointing to the number (2).

**Select the resolution.**

- (1) Touch the key of the desired resolution.
- (2) Touch the [OK] key.

## How to select the resolution

When scanning a regular text document, a resolution setting of 200x200dpi will create a sufficiently legible image. When scanning a photo or illustration, a high resolution setting (such as 600x600dpi) will produce a sharp and clear image. Note that the high-resolution setting will result in a larger file size and transmission may not be successful if there is not enough space in the USB memory. In this event, reduce the size of the image file (for example, by reducing the number of scanned pages).

 When using the automatic document feeder, the resolution setting cannot be changed once scanning has begun. However, when the document glass or the "Job Build" special mode is used, the resolution can be changed each time a new original or set of originals is placed.

 **System Settings (Administrator): Initial Resolution Setting**  
This is used to change the default resolution setting.

# AUTOMATICALLY SCANNING BOTH SIDES OF AN ORIGINAL (2-Sided Original)

The automatic document feeder can be used to automatically scan both sides of an original.

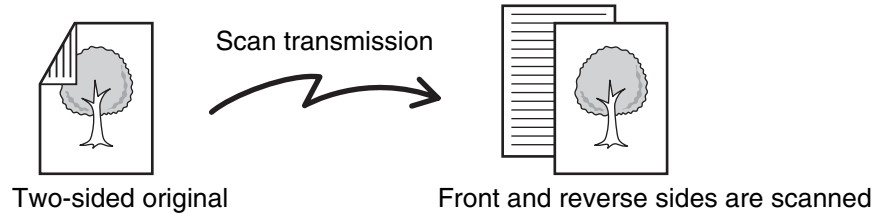

1

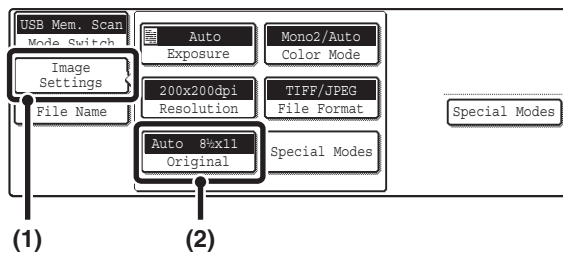

Display the original settings screen.

- (1) Touch the [Image Settings] key.
- (2) Touch the [Original] key.

2

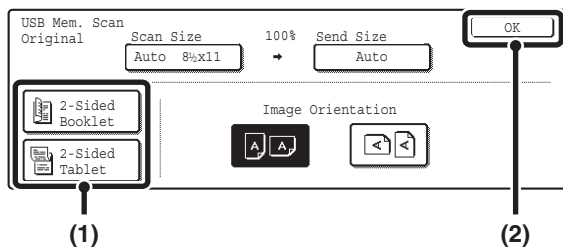

Specify whether the binding style of the two-sided original is book style or tablet style.

- (1) Touch the [2-Sided Booklet] key or the [2-Sided Tablet] key.

A book and a tablet are bound as shown below.

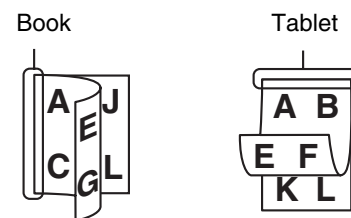

- (2) Touch the [OK] key.



To cancel two-sided scanning, touch the highlighted key so that it is no longer highlighted.



Two-sided scanning automatically turns off after scanning and transmission are finished.

---

---

# SPECIFYING THE ORIGINAL SCAN SIZE AND SEND SIZE (Enlarge/Reduce)

When the original is placed, its size is automatically detected and displayed in the base screen.

The size of the placed original is indicated as the scan size, and the size to be transmitted is indicated as the send size.

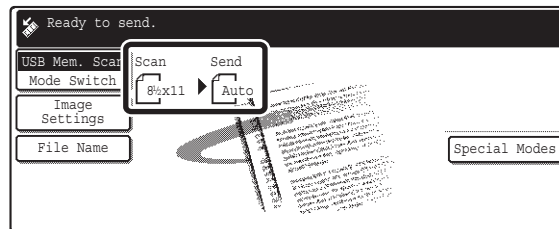

In the above screen, the scan size (the placed original) is 8-1/2" x 11" (A4) and the send size is auto. For example, if the scan size is 8-1/2" x 11" (A4) and the send size is 5-1/2" x 8-1/2" (B5), the image will be reduced before transmission.

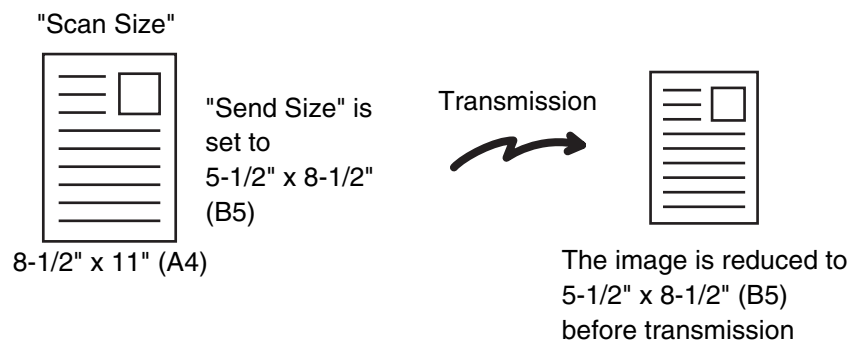

- Only standard original sizes can be automatically detected.
- If the original is a non-standard size, you must set the scan size manually.

# SPECIFYING THE SCAN SIZE OF THE ORIGINAL

If the original is a non-standard size or you wish to change the scan size, touch the [Original] key to specify the original size manually. Place the original in the document feeder tray or on the document glass and follow the steps below.

## Specifying the size using paper sizes

**1**

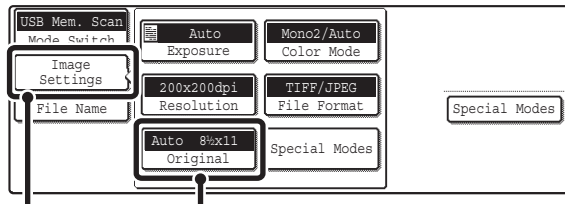

**Display the original settings screen.**

- Touch the [Image Settings] key.
- Touch the [Original] key.  
The automatically detected size appears at the top of the [Original] key.

**2**

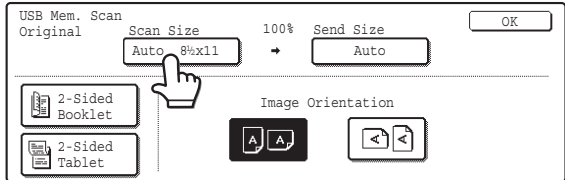

**Touch the [Scan Size] key.**

**3**

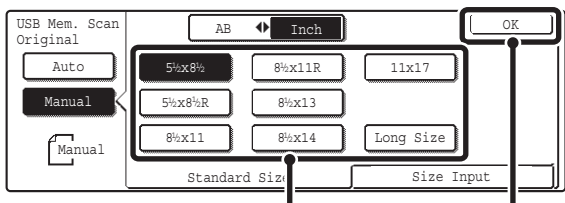

**Specify the scan size.**

- Touch the appropriate original size key.
- Touch the [OK] key.

- If you are sending a long original, touch the [Long Size] key. Use the automatic document feeder to scan a long original. (When the automatic document feeder is not installed, the [Long Size] key does not appear.) The maximum length that can be scanned is 31-1/2" (800 mm) (the maximum width is 11-5/8" (297 mm)).
- To specify an AB size for the scan size, touch the [AB ◀▶ Inch] key to highlight the [AB] side and then specify the scan size.

**4**

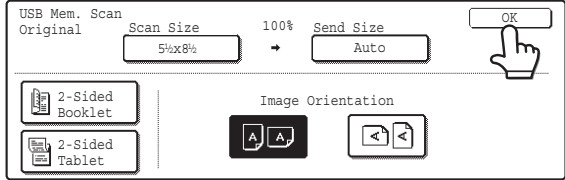

**Touch the [OK] key.**

When [Long Size] is selected, the two-sided scanning setting and send size cannot be changed. In addition, scanning will take place in Mono 2 mode.

# Specifying the size by entering numerical values.

When scanning a non-standard size original such as a postcard or card, follow these steps to specify the original size. The width can be from 2-1/2" to 17" (64 mm to 432 mm), and the length can be from 2-1/2" to 11-5/8" (64 mm to 297 mm).

1

**Display the original settings screen.**

- (1) Touch the [Image Settings] key.
- (2) Touch the [Original] key.  
The automatically detected size appears at the top of the [Original] key.

2

**Touch the [Scan Size] key.**

3

**Enter the scan size.**

- (1) Touch the [Size Input] tab.
- (2) Touch the [X] key and enter the X (horizontal) dimension with the  $\downarrow$   $\uparrow$  keys.
- (3) Touch the [Y] key and enter the Y (vertical) dimension with the  $\downarrow$   $\uparrow$  keys.
- (4) Touch the [OK] key.



**System Settings (Administrator): Original Size Detector Setting**

This is used to set the size entry screen to "inch units" or "mm units".

4

**Touch the [OK] key.**

The specified size appears in the [Scan Size] key.



- When the scan size is specified by numerical values, the send size cannot be specified.
- When the automatic document feeder is used, an original longer than 17" (432 mm) can be scanned (maximum length 31-1/2" (800 mm)). To scan a long original, touch the [Standard Size] tab in the screen of step 3 and then touch the [Long Size] key.

[Specifying the size using paper sizes](#) (page 55)

# SPECIFYING THE SEND SIZE OF THE ORIGINAL

Specify the send size as a paper size. If a send size bigger than the scan size is selected, the image will be enlarged. If a send size smaller than the scan size is selected, the image will be reduced.

 The send size cannot be specified when [Long Size] is selected for the scan size, or when the scan size is specified by numerical values.

1

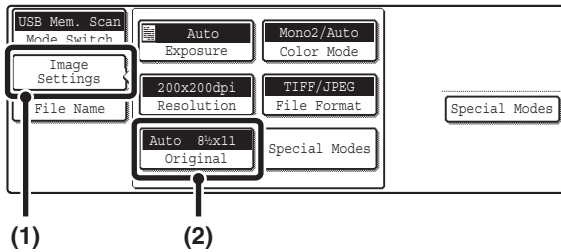

**Display the original settings screen.**

- (1) Touch the [Image Settings] key.
- (2) Touch the [Original] key.

2

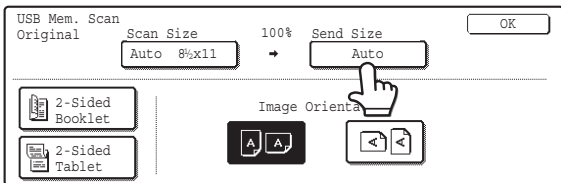

**Touch the [Send Size] key.**

3

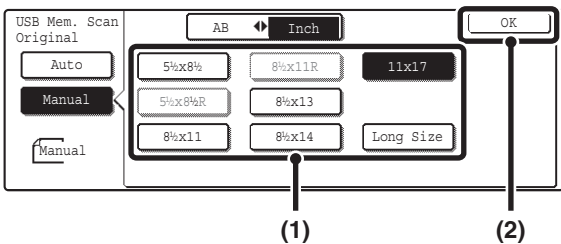

**Specify the send size.**

- (1) Touch the desired send size key.
- (2) Touch the [OK] key.



- Size keys that cannot be specified for the send size are grayed out to prevent selection.
- To specify an inch AB for the send size, touch the [AB ◀▶ Inch] key to highlight the [AB] side and then specify the send size.

4

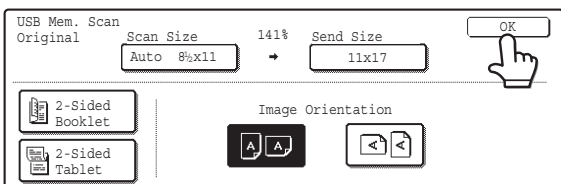

**Touch the [OK] key.**

The ratio used for reduction or enlargement of the original will appear between the "Scan Size" and the "Send Size".

# CHANGING THE COLOR MODE

This procedure is used to change the color mode used to scan the original when the [COLOR START] key (○●●●) or the [BLACK & WHITE START] key (○●) is pressed.

Start key	Mode	Scanning method
[COLOR START] key	Auto	The machine detects whether the original is color or black and white and automatically selects full color or black and white (Mono 2 or Grayscale) scanning.
	Full Color	The original is scanned in full color. This mode is best for full color originals such as catalogues.
[BLACK & WHITE START] key	Mono2	Colors in the original are scanned as black or white. This mode is best for text-only originals.
	Grayscale	The colors in the original are scanned in black and white as shades of gray (grayscale).

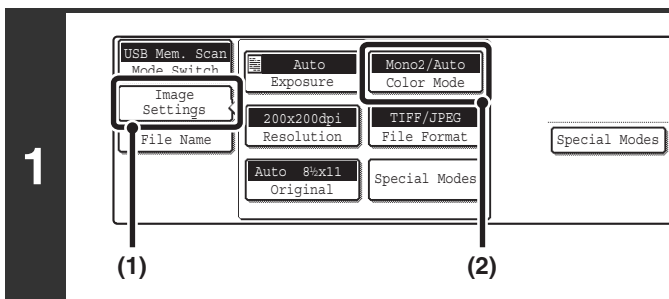

## Display the color mode screen.

- (1) Touch the [Image Settings] key.
- (2) Touch the [Color Mode] key.

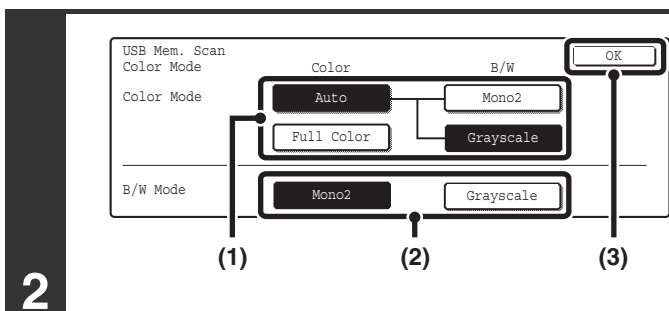

## Select the color mode.

- (1) Touch the key of the mode to be used when the [COLOR START] key (○●●●) is pressed.

You can select whether black & white scanning will take place in Mono 2 or grayscale when [Auto] is selected and a black and white original is scanned. Note that if the file format is set to JPEG, scanning will take place in grayscale.

- (2) Touch the key of the mode to be used when the [BLACK & WHITE START] key (○●) is pressed.
- (3) Touch the [OK] key.



- **System Settings (Administrator): Default Color Mode Settings**

The default color mode can be changed.

- **System Settings (Administrator): Disable Change of B/W Setting in Auto Mode**

This prohibits selection of the black and white original scanning setting when [Auto] is selected for the color mode.

# CHANGING THE FILE FORMAT

The file format (file type and compression method / compression ratio) for sending a scanned image can be changed at the time of transmission. In addition, if the scanned originals are divided into separate files, the number of pages per file can be changed.

1

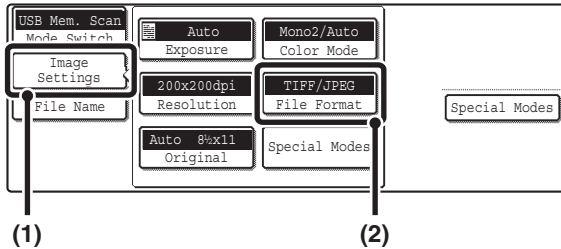

Display the format setting screen.

- (1) Touch the [Image Settings] key.
- (2) Touch the [File Format] key.

2

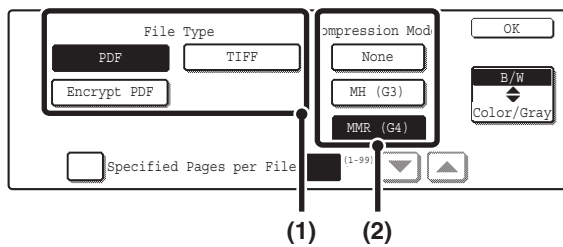

Set the format.

## ● Scanning in Mono 2

- (1) Select the file type.
- (2) Select the compression mode.

## ● Scanning in color/grayscale

- (1) Touch the indicated key to select [Color/Gray] mode.

When [Color/Gray] is highlighted, [Color/Gray] mode is selected.

- (2) Select the file type.
- (3) Select the compression ratio.

High compression results in a smaller file size, however, the image quality is slightly degraded.



- When this screen is displayed, the setting screen of [B/W] mode initially appears.
- The format set for [B/W] mode will be the file format that is used when the [BLACK & WHITE START] key (○●) is pressed with the B/W Mode set to [Mono2].
- The format set for [Color/Gray] mode will be the file format that is used when the [COLOR START] key (○○●●) is pressed, or when the [BLACK & WHITE START] key (○●) is pressed with the B/W Mode set to [Grayscale].
- The file type of [B/W] mode and the file type of [Color/Gray] mode are linked. The file type cannot be set separately for each. (When [JPEG] is selected for [Color/Gray] mode, [TIFF] is automatically selected for [B/W] mode.)



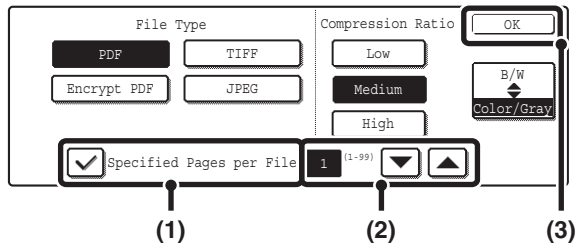

To change the number of pages per file, enter the number of pages and exit the format settings.

- (1) Touch the [Specified Pages per File] checkbox so that a checkmark  appears.
- (2) Set the number of pages per file with the   keys.
- (3) Touch the [OK] key.



- When a checkmark does not appear in the [Specified Pages per File] checkbox , one file is created for all scanned pages.
- When [Specified Pages per File] is selected, consecutive numbers are added to the created file names.
- When [JPEG] is selected for the file type, one file is created for each page (a file cannot be created for multiple pages). For this reason, the [Specified Pages per File] checkbox does not appear.



When [Encrypt PDF] is selected, a password entry screen will appear when the [START] key is pressed to begin scanning and transmission.

Touch the [Entry] key in the displayed screen to open the keyboard screen. Enter a password (maximum of 32 characters) and touch the [OK] key. Scanning and transmission will begin.

# CHANGING THE FILE NAME

The file name can be changed when performing a scan transmission. One of the preset file names can be selected or a file name can be directly entered.

- If the file name is not changed, the settings in the Web page are used.
- Selections for the file name are configured by clicking [Application Settings] and then [Network Scanner Settings] in the Web page menu. (Administrator rights are required.)

1

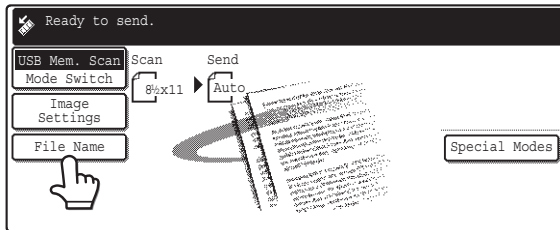

Touch the [File Name] key.

2

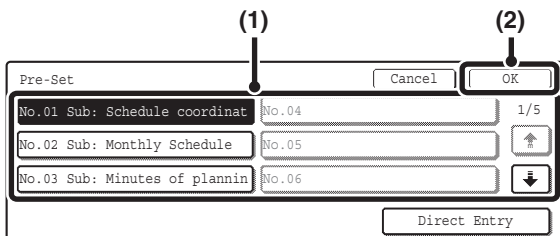

Enter a file name.

- (1) Touch a Pre-Set text key.
- (2) Touch the [OK] key.

- If you wish to directly enter the text, touch the [Direct Entry] key to open the text entry screen. Enter the file name and touch the [OK] key. Up to 54 characters can be entered. For the procedure for entering text, see "6. ENTERING TEXT" in the User's Guide.
- The text in a pre-set text key can be edited by touching the pre-set text key and then the [Direct Entry] key. The text entry screen will appear with the selected pre-set text entered. (When a destination is stored using the Web page, up to 80 characters can be entered. However, only 54 characters will appear and can be edited in the touch panel.)

When storing pre-set text for the file name in the Web page, up to 80 characters can be entered.

**System Settings (Administrator): The Number of File Name/Subject/Body Keys Displayed Setting**  
This is used to select the number of subjects and file names displayed in one screen (3 or 6).

# 5

# BASIC PROCEDURE FOR TRANSMISSION IN INTERNET FAX MODE

## SENDING A FAX IN INTERNET FAX MODE

When a default address is configured in "Default Address Setting" in the system settings (administrator), the mode cannot be changed, the destination cannot be changed, and destinations cannot be added. To switch to Internet fax mode, touch the [Cancel] key in the touch panel and follow the steps below.

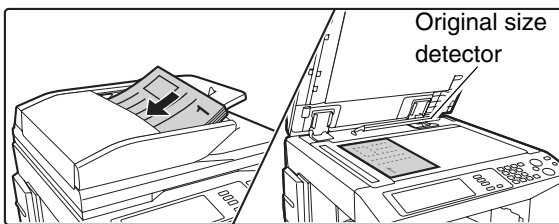

### Place the original.

Place the original face up in the document feeder tray, or face down on the document glass.

Do not place any objects under the original size detector. Closing the automatic document feeder with an object underneath may damage the original size detector plate and prevent correct detection of the document size.

Place 5-1/2" x 8-1/2" (A5) size originals in portrait (vertical) orientation (📄). If placed in landscape (horizontal) orientation (📄), an incorrect size will be detected. For an 5-1/2" x 8-1/2"R (A5R) size original, enter the original size manually.

#### Image rotation

8-1/2" x 11" and 5-1/2" x 8-1/2"R (A4, B5R, and A5R) originals are rotated 90 degrees and transmitted in 8-1/2" x 11"R or 5-1/2" x 8-1/2" (A4R, B5, or A5) orientation. (8-1/2" x 11"R and 5-1/2" x 8-1/2" (A4R, B5, and A5) originals cannot be rotated for transmission.)

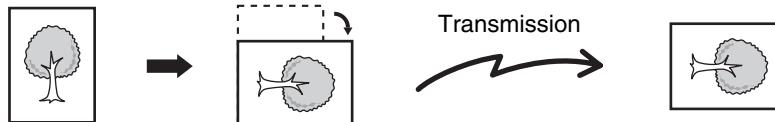

Originals cannot be scanned in succession from both the automatic document feeder and the document glass and sent in a single transmission.

#### System Settings (Administrator): Rotation Sending Setting

This is used to select whether or not a scanned original image is rotated before transmission.

The default setting is: rotate 8-1/2" x 11" (A4) to 8-1/2" x 11"R (A4R), and 5-1/2" x 8-1/2"R (B5R or A5R) to 5-1/2" x 8-1/2" (B5 or A5).

# 2

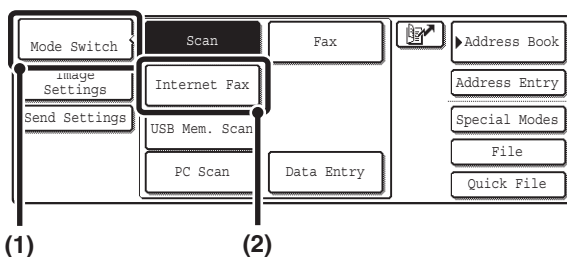

### Change to Internet fax mode.

- (1) Touch the [Mode Switch] key.
- (2) Touch the [Internet Fax] key.

3

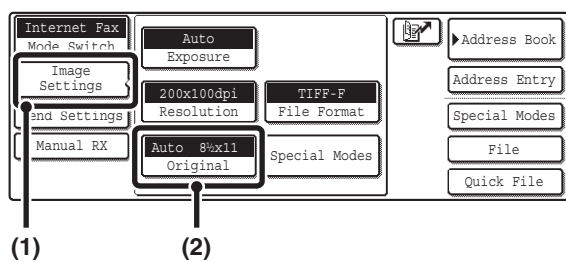

## Display the original settings screen.

- (1) Touch the [Image Settings] key.
- (2) Touch the [Original] key.



The current settings of the [Exposure], [Resolution], [Original], and [File Format] keys appear in the top half of each key. Touch each key to change the settings.

- ✎ [CHANGING THE EXPOSURE](#) (page 65), [CHANGING THE RESOLUTION](#) (page 66), [AUTOMATICALLY SCANNING BOTH SIDES OF AN ORIGINAL \(2-Sided Original\)](#) (page 67), [SPECIFYING THE ORIGINAL SCAN SIZE AND SEND SIZE \(Enlarge/Reduce\)](#) (page 68), [CHANGING THE FILE FORMAT](#) (page 72), [7. CONVENIENT FUNCTIONS](#) (page 83)

4

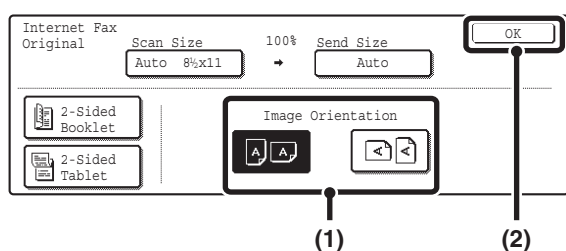

## Specify the orientation in which the original is placed.

When specifying the orientation of the image to be transmitted, specify the orientation of the original placed in step 1.

- (1) Touch the appropriate orientation key.

If the top edge of the original is up, touch the key. If the top edge of the original is to the left, touch the key.

- (2) Touch the [OK] key.

You will return to the screen of step 3. Touch the [Image Settings] key to close the menu.



The original orientation is initially set to . If the original was placed with the top edge up, this step is not necessary.

5

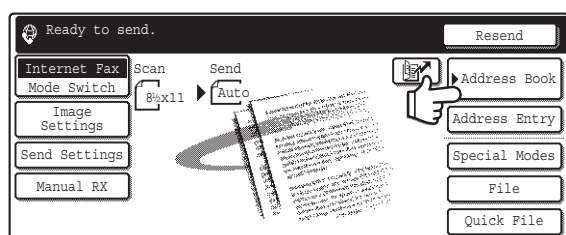

## Touch the [Address Book] key.

6

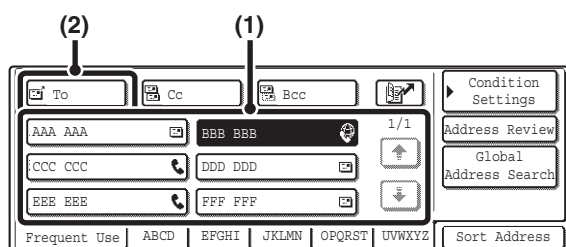

## Specify the destination.

- (1) Touch the key of the desired destination.

The icon appears in one-touch keys in which Internet fax addresses are stored.

- (2) Touch the [To] key.

The destination is specified.



- After a one-touch key is touched, if the screen is changed without touching the [To] key, the destination is automatically specified.
- In addition to selecting a one-touch key, a destination can also be specified by entering it manually or retrieving it from a global address book. For more information, see "2. ENTERING DESTINATIONS" (page 19).

7



## Press the [BLACK & WHITE START] key (○●).

Scanning begins.

- If the original is placed on the document glass, the [Read-End] key appears in the touch panel. To scan only one original, go to step 9. To scan multiple originals, go to the next step.
- If the original was inserted in the document feeder tray, a beep will sound when scanning is completed and transmission will take place.

8



## If the original was placed on the document glass, replace it with the next original and press the [BLACK & WHITE START] key (○●).

Repeat until all originals have been scanned.



The exposure, resolution, and scan size/send size can be changed for each original page that is scanned.

9

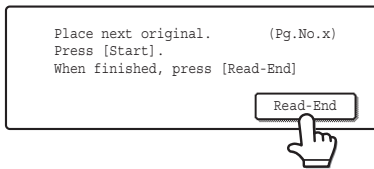

## Touch the [Read-End] key.

A beep will sound to indicate that the operation is completed. Open the automatic document feeder and remove the original.



If no action is taken for one minute after the confirmation screen appears, scanning automatically ends and the transmission is reserved.



- When all originals have been scanned, "Job stored." will be displayed together with a job control number. This number can be used to locate the job in the Transaction Report or in the Image Sending Activity Report. If the job is a broadcast transmission, this number will also appear in the key of the job in the job status screen. For this reason, making a note of the number is useful for checking the result.
- If the memory becomes full while the originals are being scanned, a message will appear and scanning will stop.
- **Storing a mail signature**  
You can have preset text automatically added at the end of e-mail messages as a mail signature. This is convenient when you wish to have a corporate policy or other preset text appear at the bottom of e-mail messages. To store the text for the mail signature, click [Application Settings] and then [Network Scanner Settings] in the Web page menu. (Administrator rights are required.) Up to 900 characters can be entered. (The mail signature is not included in the maximum number of characters that can be entered in the e-mail message.)  
Use "Pre-Setting Mail Signature" in the system settings (administrator) to specify whether or not a mail signature is added.



### To cancel scanning...

Press the [STOP] key (⊘) to cancel the operation.



### • System Settings (Administrator): I-Fax Send Settings

This is used to select Internet fax transmission settings such as the receive report setting, rotation setting, size restriction setting, and sender information attachment setting.

### • System Settings (Administrator): Pre-Setting Mail Signature

Use this setting to specify whether or not a mail signature is added at the end of e-mail messages. By factory default, a mail signature is not added.

# CHANGING THE EXPOSURE

The exposure can be changed to match the darkness of the original.

1

**Display the exposure setting screen.**

- (1) Touch the [Image Settings] key.
- (2) Touch the [Exposure] key.

2

**Select the exposure.**

- (1) Touch the [Manual] key.
- (2) Adjust the exposure with the keys.  
When the exposure is set to [Auto], the keys cannot be used.  
The exposure darkens when the key is touched, and lightens when the key is touched.  
To return to auto exposure adjustment, touch the [Auto] key.
- (3) Touch the [OK] key.

- When using the document glass to scan multiple original pages, the exposure setting can be changed each time you change pages. When using the automatic document feeder, the exposure setting cannot be changed once scanning has begun. (However, when the special mode "Job Build" is used, the exposure can be changed each time a new set of originals is inserted.)
- System Settings (Administrator): Default Exposure Settings**  
This is used to change the default exposure setting.

## How to select the exposure

Exposure		When to select
Auto		This setting automatically adjusts the exposure for light and dark parts of the original.
Manual	1 to 2	Select this setting when the original consists of dark text.
	3	Select this setting for a normal original (neither dark nor light).
	4 to 5	Select this setting when the original consists mostly of faint text.

# CHANGING THE RESOLUTION

The resolution setting can be selected.

**1**

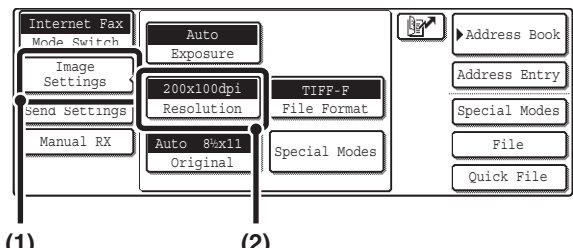

**Display the resolution setting screen.**

- (1) Touch the [Image Settings] key.
- (2) Touch the [Resolution] key.

**2**

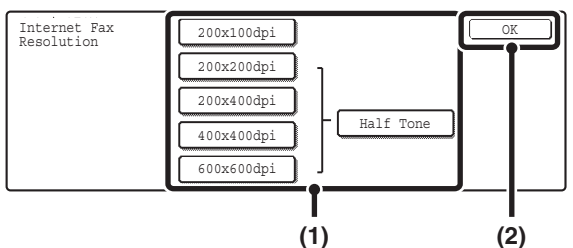

**Select the resolution.**

- (1) Touch the key of the desired resolution.
- (2) Touch the [OK] key.

 When a resolution other than [200x100dpi] is selected, the [Half Tone] key can be touched to select halftone. When the original has many gradations of light and dark such as a photo or color illustration, halftone provides a more attractive image than regular transmission.

## How to select the resolution

For normal text originals, 200x100dpi produces an image that is sufficiently legible. For photos and illustrations, a high resolution setting (600x600dpi, etc.) or halftone setting will produce a sharp image. However, a high resolution setting or halftone setting will result in a large file, and if the file is too large, transmission may not be possible. In this event, reduce the number of pages scanned or take other measures to decrease the file size.

-  When using the automatic document feeder, the resolution setting cannot be changed once scanning has begun. However, when the document glass or the "Job Build" special mode is used, the resolution can be changed each time a new original or set of originals is placed.
- When [TIFF-S] is selected for the format, only [200x100dpi] or [200x200dpi] can be selected.

 **System Settings (Administrator): Initial Resolution Setting**  
This is used to change the default resolution setting.

# AUTOMATICALLY SCANNING BOTH SIDES OF AN ORIGINAL (2-Sided Original)

The automatic document feeder can be used to automatically scan both sides of a two-sided original.

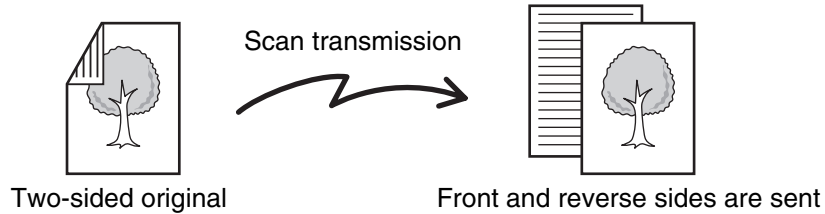

1

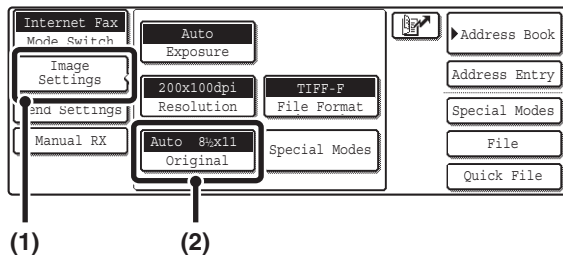

Display the original settings screen.

- (1) Touch the [Image Settings] key.
- (2) Touch the [Original] key.

2

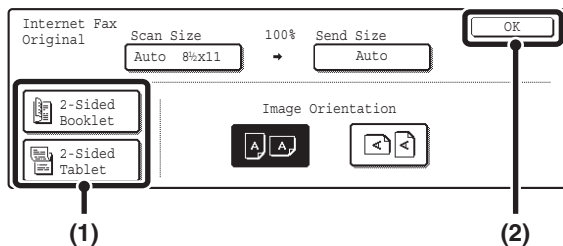

Specify whether the binding style of the two-sided original is book style or tablet style.

- (1) Touch the [2-Sided Booklet] key or the [2-Sided Tablet] key.

A book and a tablet are bound as shown below.

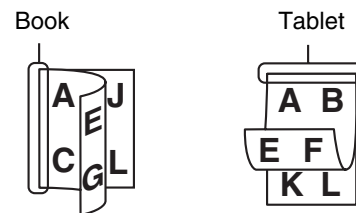

- (2) Touch the [OK] key.



To cancel two-sided scanning, touch the highlighted key so that it is no longer highlighted.



Two-sided scanning automatically turns off after the Internet fax is transmitted.



---

---

# SPECIFYING THE ORIGINAL SCAN SIZE AND SEND SIZE (Enlarge/Reduce)

When the original is placed, its size is automatically detected and displayed in the base screen.

The size of the placed original is indicated as the scan size, and the size to be transmitted is indicated as the send size.

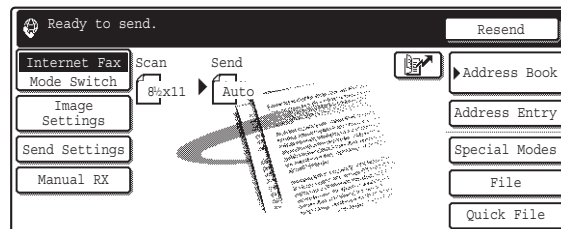

In the above screen, the scan size (the placed original) is 8-1/2" x 11" (A4) and the send size is auto. For example, if the scan size is 8-1/2" x 11" (A4) and the send size is 5-1/2" x 8-1/2" (B5), the image will be reduced before transmission.

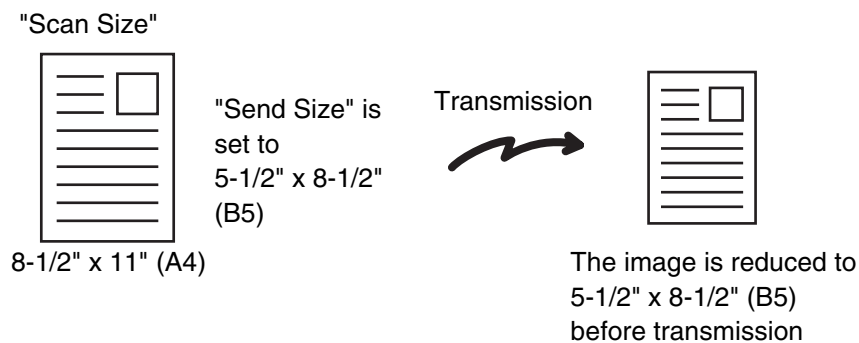

- Only standard original sizes can be automatically detected.
- If the original is a non-standard size, you must set the scan size manually.

# SPECIFYING THE SCAN SIZE OF THE ORIGINAL

If the original is a non-standard size or you wish to change the scan size, touch the [Original] key to specify the original size manually. Place the original in the document feeder tray or on the document glass and follow the steps below.

## Specifying the size using paper sizes

**1**

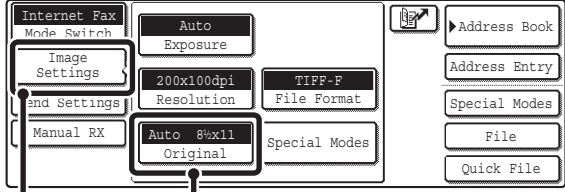

**Display the original settings screen.**

- Touch the [Image Settings] key.
- Touch the [Original] key.

The automatically detected size appears at the top of the [Original] key.

**2**

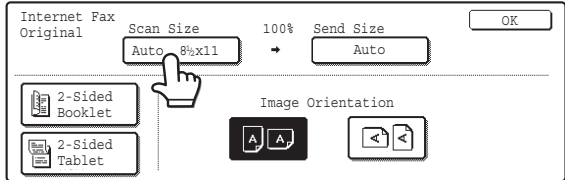

**Touch the [Scan Size] key.**

**3**

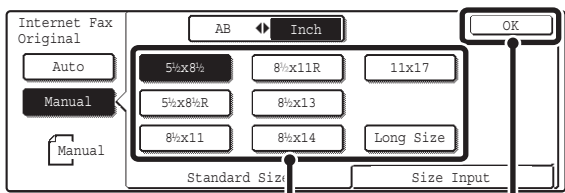

**Specify the scan size.**

- Touch the appropriate original size key.
- Touch the [OK] key.



- If you are sending a long original, touch the [Long Size] key. Use the automatic document feeder to scan a long original. (When the automatic document feeder is not installed, the [Long Size] key does not appear.) The maximum length that can be scanned is 31-1/2" (800 mm) (the maximum width is 11-5/8" (297 mm)).
- To specify an AB size for the scan size, touch the [AB ◀▶ Inch] key to highlight the [AB] side and then specify the scan size.

**4**

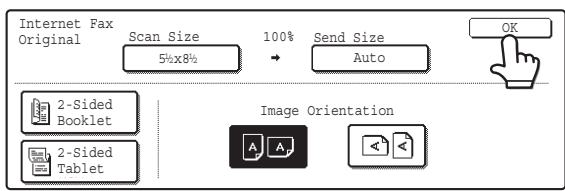

**Touch the [OK] key.**



When [Long Size] is selected, the two-sided scanning setting and send size cannot be changed.

# Specifying the size by entering numerical values.

When scanning a non-standard size original such as a postcard or card, follow these steps to specify the original size. The width can be from 2-1/2" to 17" (64 mm to 432 mm), and the length can be from 2-1/2" to 11-5/8" (64 mm to 297 mm).

1

**Display the original settings screen.**

- (1) Touch the [Image Settings] key.
- (2) Touch the [Original] key.

The automatically detected size appears at the top of the [Original] key.

2

**Touch the [Scan Size] key.**

3

**Enter the scan size.**

- (1) Touch the [Size Input] tab.
- (2) Touch the [X] key and enter the X (horizontal) dimension with the ▼ ▲ keys.
- (3) Touch the [Y] key and enter the Y (vertical) dimension with the ▼ ▲ keys.
- (4) Touch the [OK] key.



**System Settings (Administrator): Original Size Detector Setting**

This is used to set the size entry screen to "inch units" or "mm units".

4

**Touch the [OK] key.**

The specified size appears in the [Scan Size] key.

- When the scan size is specified by numerical values, the send size cannot be specified.
  - When the automatic document feeder is used, an original longer than 17" (432 mm) can be scanned (maximum length 31-1/2" (800 mm)). To scan a long original, touch the [Standard Size] tab in the screen of step 3 and then touch the [Long Size] key.
- 🔗 [Specifying the size using paper sizes](#) (page 69)

# SPECIFYING THE SEND SIZE OF THE ORIGINAL

Specify the send size as a paper size. If a send size bigger than the scan size is selected, the image will be enlarged. If a send size smaller than the scan size is selected, the image will be reduced.

- The send size cannot be specified when [Long Size] is selected for the scan size, or when the scan size is specified by numerical values.
- The send size cannot be specified when [TIFF-S] is selected for the format. (The send size is fixed at 8-1/2" x 11"R (A4R).)

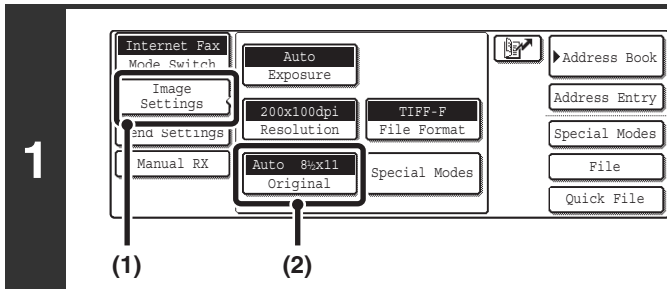

Display the original settings screen.

- (1) Touch the [Image Settings] key.
- (2) Touch the [Original] key.

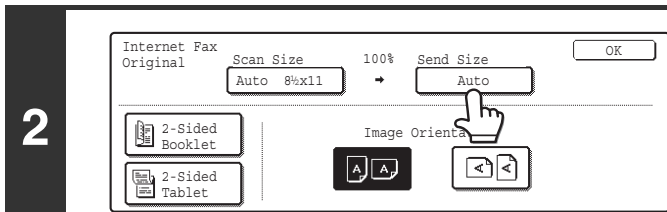

Touch the [Send Size] key.

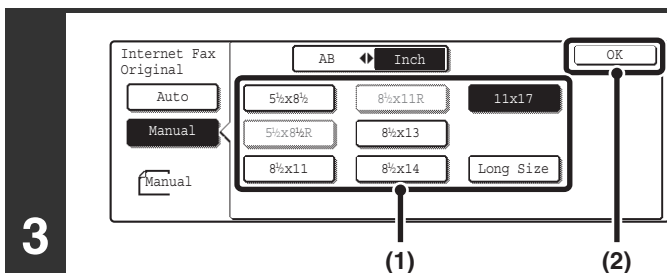

Specify the send size.

- (1) Touch the desired send size key.
- (2) Touch the [OK] key.

- Size keys that cannot be specified for the send size are grayed out to prevent selection.
- To specify an AB size for the send size, touch the [AB ◀▶ Inch] key to highlight the [AB] side and then specify the send size.

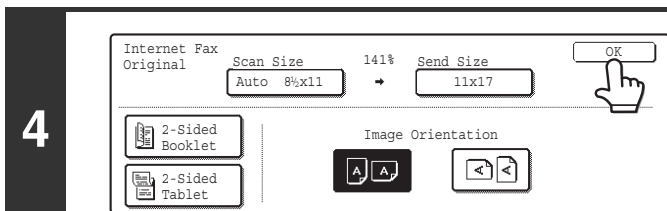

Touch the [OK] key.

The ratio used for reduction or enlargement of the original will appear between the "Scan Size" and the "Send Size".

# CHANGING THE FILE FORMAT

The file format for sending an Internet fax is normally set to [TIFF-F]. If the destination Internet fax machine does not support full mode (it only supports simple mode), follow the steps below to select [TIFF-S].

1

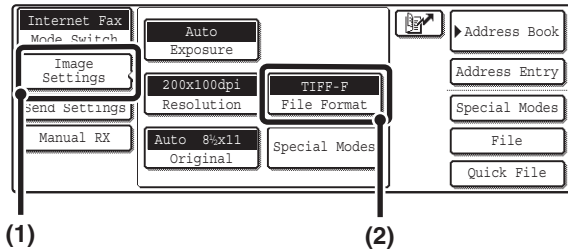

Display the format setting screen.

- (1) Touch the [Image Settings] key.
- (2) Touch the [File Format] key.

2

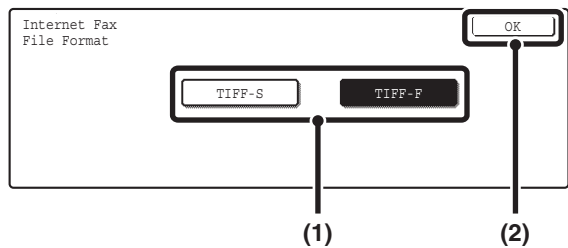

Select the file format.

- (1) Touch the key of the desired format.
- (2) Touch the [OK] key.

-  When [TIFF-S] is selected, the transmission settings are restricted as follows:
- Resolution: The selections are [200x100dpi] and [200x200dpi]. If [TIFF-S] is selected after [200x400dpi], [400x400dpi] or [600x600dpi] is selected, the resolution automatically changes to [200x200dpi].
  - Send size: Always 8-1/2" x 11"R (A4R). If [TIFF-S] is selected after the send size is changed, the send size is automatically changed to 8-1/2" x 11"R (A4R). If a size larger than 8-1/2" x 11" (A4) is scanned, the size will automatically be reduced to 8-1/2" x 11"R (A4R).

# CHANGING THE SUBJECT, FILE NAME, AND MESSAGE

The subject, file name, and message can be changed when performing an Internet fax transmission. Preset items can be selected or text can be directly entered.

- If the subject and file name are not changed, the settings in the Web page are used.
- Selections for the subject, file name, and message are configured by clicking [Application Settings] and then [Network Scanner Settings] in the Web page menu. (Administrator rights are required.)
- For the procedure for entering text, see "6. ENTERING TEXT" in the User's Guide.

1

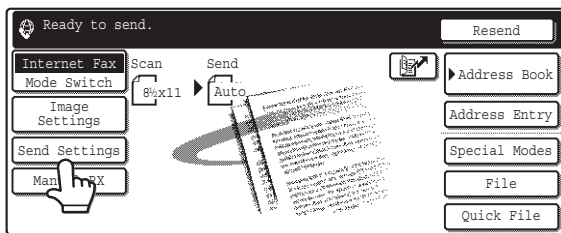

Touch the [Send Settings] key.

2

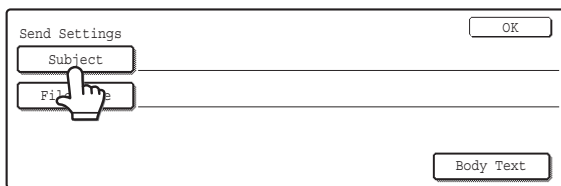

To change the subject, touch the [Subject] key.

3

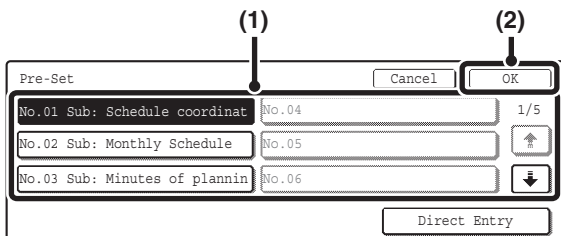

Enter the subject.

- (1) Touch a Pre-Set text key.
- (2) Touch the [OK] key.

- If you wish to directly enter the text, touch the [Direct Entry] key to open the text entry screen. Enter the text and touch the [OK] key. Up to 54 characters can be entered.
- The text in a pre-set text key can be edited by touching the pre-set text key and then the [Direct Entry] key. The text entry screen will appear with the selected pre-set text entered. (When a destination is stored using the Web page, up to 80 characters can be entered. However, only 54 characters will appear and can be edited in the touch panel.)

4

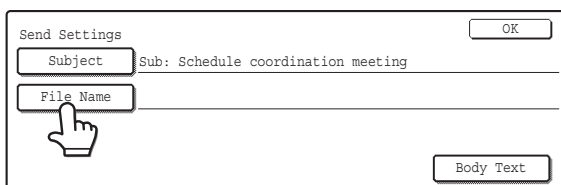

To change the file name, touch the [File Name] key.

The file name is entered in the same way as the subject.

- Up to 54 characters can be entered for the file name.

5

To change the message, touch the [Body Text] key.

6

Enter the message and touch the [OK] key.

- To select a pre-set message previously stored in the Web page, touch the [Pre-Set Select] key.
- To directly enter the message, touch the [Edit] key.



- 1800 characters can be entered. (A line break counts as one character.)
- To clear the entered text, touch the [Clear All] key.
- Each line of the entered text can be selected with the [Down Arrow] [Up Arrow] keys. To edit the selected line, touch the [Edit] key. The text entry screen will appear with the selected text entered.

7

Touch the [OK] key.



When storing pre-set text for the subject and file name in the Web page, up to 80 characters can be entered.



**System Settings (Administrator): The Number of File Name/Subject/Body Keys Displayed Setting**

This is used to select the number of subjects and file names displayed in one screen (3 or 6).

# 6

## CHECKING THE STATUS OF TRANSMISSION/RECEPTION JOBS

This chapter explains how to check the status of reserved transmission jobs and received Internet faxes.

### JOB STATUS SCREEN

The job status screen is displayed when the [JOB STATUS] key on the operation panel is pressed. The job status screen shows the status of jobs by mode. When the [JOB STATUS] key is pressed, the job status screen of the mode that was being used before the key was pressed appears.

**Example: Pressing the key in scan mode**

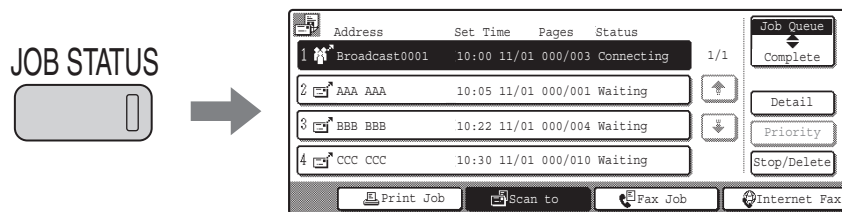

Reserved transmissions and received Internet faxes are referred to as jobs here.

 The left edge of the job status screen appears at the left edge of the touch panel when the base screen is displayed. The left edge of the job status screen can be touched to display the job status screen without pressing the [JOB STATUS] key.

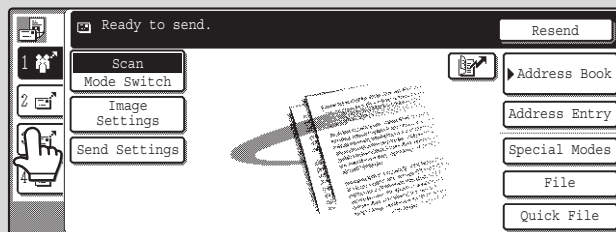



# JOB QUEUE SCREEN AND COMPLETED JOB SCREEN

The job status screen consists of two screens: the job queue screen that shows reserved jobs and the job currently in progress, and the completed jobs screen. To switch between the two screens, touch the job status screen selector key ((2) below).

## Job queue screen

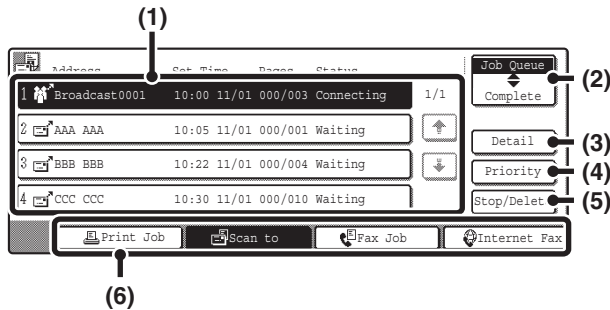

## Complete screen

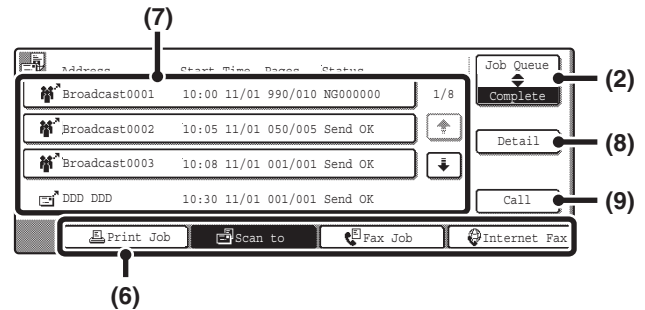

### (1) Job queue screen

Jobs are shown as keys in the order they were reserved. Each key shows information on the job and its current status.

☞ [Job key display](#) (page 77)

### (2) Job status screen selector key

Touch this key to switch between the job queue screen and the completed jobs screen.

### (3) Job queue screen [Detail] key

This shows detailed information on broadcast transmission jobs and the status of jobs. Select the key of the desired job in the job queue screen (1) and then touch the [Detail] key.

### (4) [Priority] key

Touch this key to give priority to a selected job.

☞ [GIVING PRIORITY TO A SCAN TRANSMISSION JOB](#) (page 82)

### (5) [Stop/Delete] key

Touch this key to stop or delete a selected job.

☞ [STOPPING A SCAN JOB BEING TRANSMITTED OR WAITING TO BE TRANSMITTED](#) (page 81)

### (6) Mode switch keys

Use these keys to change the job status screen mode.

### (7) Completed jobs screen

This shows up to 99 completed transmission or reception jobs in each mode. A description of the job and the result (status) are shown.

A broadcast transmission job is shown as a key.

### (8) Completed jobs screen [Detail] key

This shows detailed information on the results of completed broadcast transmissions and jobs that used the document filing function. Select the key of the desired job in the completed jobs screen (7) and then touch the [Detail] key.

☞ [CHECKING COMPLETED JOBS](#) (page 80)

### (9) [Call] key

Touch this key to call up and use a transmission or reception job stored with the document filing function.

# Job key display

The following information is shown in the job queue keys and completed job keys that appear in the job status screen.

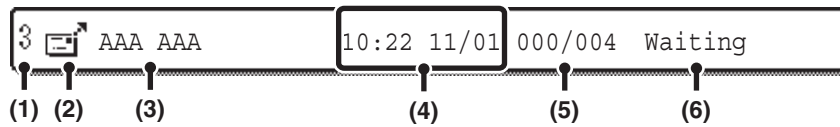

**(1) Displays the number (position) of the job in the job queue.**  
 When the job currently being transmitted is finished, the job moves up one position in the job queue. This number does not appear in keys in the completed jobs screen.

**(2) Mode icon**  
 This indicates the type of job.

Icon	Job type
	Scan to E-mail
	Scan to FTP
	Scan to Network Folder
	Scan to Desktop
	Internet fax transmission
	Internet fax reception
	PC-I-Fax transmission
	Broadcast transmission

**(3) Name of communicating party (address)**  
 For a transmission, the name or address of the destination. For a reception, the address of the sending party.  
 For a broadcast transmission, the function name and a broadcast control number (4-digits).

**(4) Time reserved / Time started**  
 In the job queue screen, the date and time the job was reserved. In the completed jobs screen, the date and time the job was started.

**(5) Number of pages**  
 Shows the number of pages transmitted / total number of original pages.

**(6) Status**  
 Shows the job status.

- Job in progress

Display	Status
"Connecting"	Connecting to the destination.
"Sending"	Sending data.
"Receiving"	Receiving an Internet fax.
"Stopped"	The job has been stopped.
"Error"	An error occurred while the job was being executed.

- Job waiting to be executed

Display	Status
"Waiting"	The job is waiting to be executed.
"Retry Mode"	The job is being re-attempted due to a communication error or other problem.
"Stopping"	The job has been stopped.
"Report Wait"	An Internet fax has been sent for which a receive report was requested, and the machine is waiting for the receive report.
A day and time is displayed	Timer transmission job (the specified time is displayed)

- Completed job

Display	Status
"Send OK"	Transmission was completed.
"In Memory"	An Internet fax has been received but has not yet been printed.
"Printed"	A received Internet fax has been printed.
"Forward OK"	A received Internet fax has been forwarded.
"Holding"	Received Internet fax held by print hold.
"Stopped"	The job was stopped.

Display	Status
"Number of successful transmission destinations / Total destinations OK"	A broadcast transmission has been completed. If transmission to 3 destinations was successful out of a total of 5, "003/005 OK" will appear.
"No Response"	An error occurred because there was no response from the destination.
"OK Report"	A receive report was requested for a transmission, the transmission was completed normally, and the receive report was received from the destination.
"NG Report"	A receive report was requested for a transmission, however, the transmission did not take place correctly and a transmission failed report was received.
"No Report"	An e-mail was received without an attached file and thus printing was not possible.
"Received"	An e-mail was received, however, the attached file was not a TIFF-F file or there was no attached file, and thus printing was not possible.
"Rejected"	An Internet fax was sent from a party that is blocked.
"NGxxxxx"	Transmission/reception was not successful because a communication error occurred (a 6-digit error code appears in xxxxxx).
"Error"	An error occurred while the job was being executed.

# OPERATION WHEN A JOB IN THE JOB QUEUE IS COMPLETED

When a normal transmission job is completed, it moves to the completed jobs screen and "Send OK" appears in the status column.

Received Internet faxes, timer transmission jobs, and forwarding jobs are handled in the job status screen as explained below.

## Internet fax reception jobs

While an Internet fax is being received, "Receiving" appears.

When reception is completed, the job moves to the completed jobs screen and "In Memory" appears.

When printing is finished, the status changes to "Printed" and the job is completed.

## Timer transmission jobs

A timer transmission job appears at the bottom of the job queue until the specified time arrives.

When the specified time arrives, the job is executed. If another job is in progress, the timer job is started when the other job is completed.

## Internet fax transmission jobs that request a receive report

After completion of an Internet fax transmission job that requests a receive report, the job is placed on standby at the bottom of the job queue screen. "Report Wait" appears in the status column. When the receive report is received from the destination, or if the report is not received within the timeout time, the job moves to the completed jobs screen.

## Reception jobs when "Inbound Routing Settings" are enabled

When "Inbound Routing Settings" are enabled, reception jobs are handled as follows depending on the print setting.

 [FORWARDING A RECEIVED INTERNET FAX TO AN E-MAIL ADDRESS \(Inbound Routing Settings\)](#) (page 114)

- **Received Internet fax is not printed**

"Receiving" appears while the Internet fax is being received. When reception is completed, the job moves to the job queue of the job status screen of scan mode.

- **Received Internet fax is printed**

When reception is completed, the job moves to the completed jobs screen and "In Memory" appears. When printing ends, the status changes to "Printed" and the job is completed. In addition, the job is added to the job queue of the job status screen of scan mode. When forwarding received Internet faxes is finished, "Forward OK" appears.

# CHECKING COMPLETED JOBS

You can check a list of the destinations, the destinations for which transmission failed, and other detailed information on completed broadcast transmission jobs and jobs that used document filing function. Touch the key of the job for which you wish to display information in the completed jobs screen and touch the [Detail] key. The job detail screen (see below) will appear.

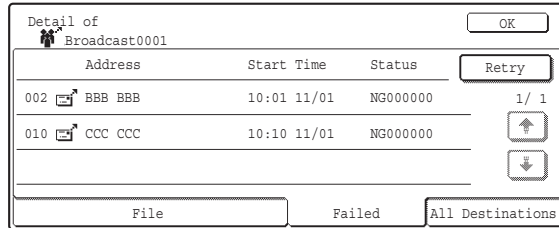

The job name appears at the top of the job detail screen.

To view details on the job, touch one of the tabs. The following information appears on each tab.

Tab name	Information displayed
File	Shows information on a transmission/reception that used document filing function. To call up the file and use it, touch the [Call] key.
Failed	Shows information on addresses for which communication failed. Address: Address name or number Start time: Time at which communication began. Status: Description of failure (error) The [Retry] key can be touched to re-attempt transmission to that address.
All Destinations	Shows all addresses specified in the job. Address: Address name or number Start time: Time at which communication began. Status: Communication result The [Retry] key can be touched to transmit to all addresses again.

# STOPPING A SCAN JOB BEING TRANSMITTED OR WAITING TO BE TRANSMITTED

Follow the steps below to stop a job that is being transmitted or is waiting to be transmitted.

1

JOB STATUS



Press the [JOB STATUS] key.

2

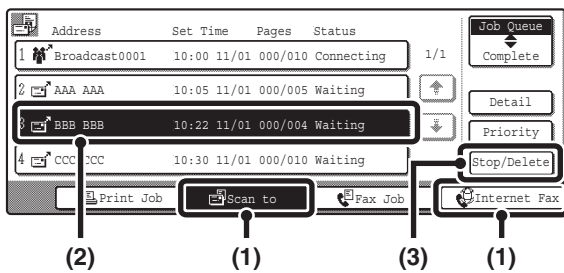

Select the job that you wish to stop.

- (1) Touch the mode key of the job to be stopped.
- (2) Touch the key of the job to be stopped.
- (3) Touch the [Stop/Delete] key.

3

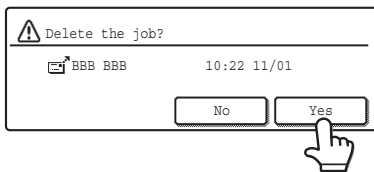

Touch the [Yes] key.



If you do not want to stop the selected job...  
Touch the [No] key.



Printing of a received Internet fax cannot be stopped.

---

---

# GIVING PRIORITY TO A SCAN TRANSMISSION JOB

When multiple jobs are waiting to be transmitted, the jobs are normally transmitted in the order they were reserved. If you need to give priority to a job and send it ahead of the other jobs, follow the steps below.

1

JOB STATUS



Press the [JOB STATUS] key.

2

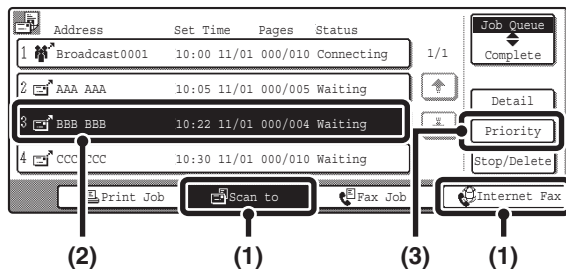

Select the job to which you wish to give priority.

- (1) Touch the mode key of the job to be given priority.
- (2) Touch the key of the job to be given priority.
- (3) Touch the [Priority] key.

The selected job moves up to the position immediately following the job in progress. The job will be executed when the job in progress is completed.

# 7

## CONVENIENT FUNCTIONS

This chapter explains convenient functions for performing scan transmissions. These functions make it easy to perform scan transmissions for a variety of purposes.

### SENDING THE SAME IMAGE TO MULTIPLE DESTINATIONS (Broadcast Transmission)

The same scanned image can be sent to multiple scan mode destinations (Scan to E-mail, Scan to FTP, Scan to Desktop), Internet fax mode destinations, and fax mode destinations in a single operation. Up to 500 destinations (including a combined maximum of 200 Scan to FTP and Scan to Desktop destinations) can be selected for one broadcast operation.

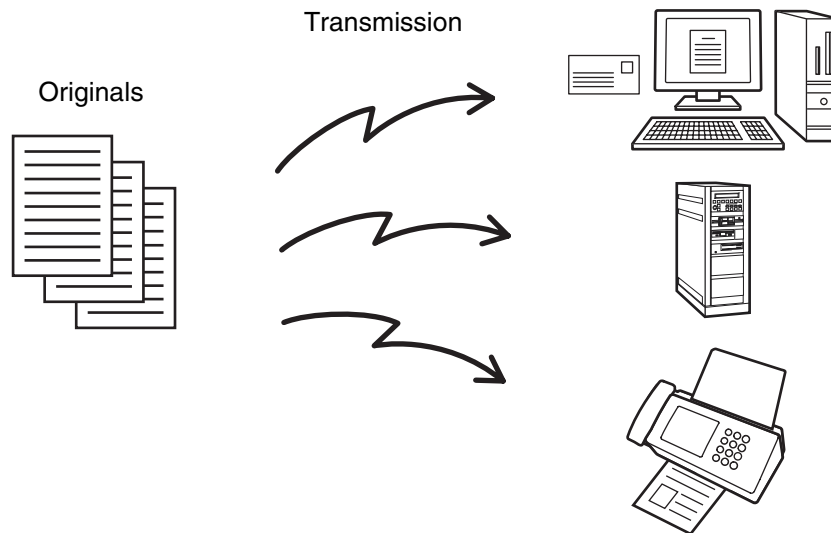

If you frequently use broadcasting to send images to the same group of destinations, it is convenient to store those destinations in a group key.

1

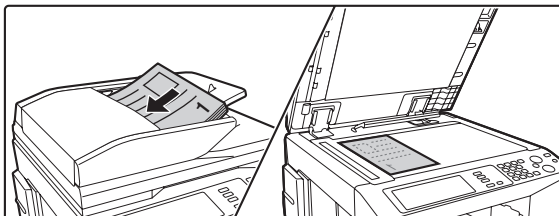

#### Place the original.

Place the original face up in the document feeder tray, or face down on the document glass.



2

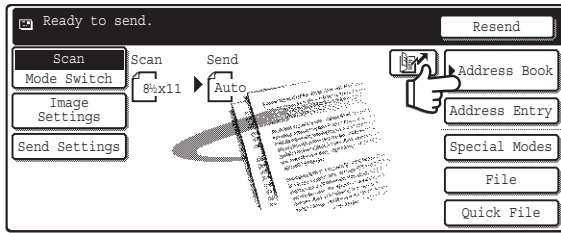

### Touch the [Address Book] key.

To directly enter a destination address, touch the [Address Entry] key.

3

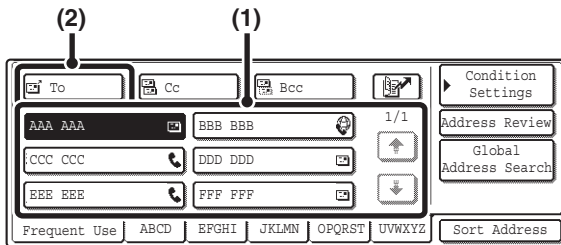

### Specify the destination.

- (1) Touch the one-touch key of the desired destination.
- (2) Touch the [To] key.  
The destination is specified.
- (3) Repeat steps (1) and (2) until all addresses are selected.



- To add Cc or Bcc recipients, select a recipient and touch the [Cc] key or the [Bcc] key.
- If "Must Input Next Address Key at Broadcast Setting" is enabled in the system settings (administrator), touch the [Next Address] key before specifying the next destination.
- One-touch keys that cannot be used for broadcast transmission are grayed out to prevent selection.
- If a Scan to FTP (Hyperlink) address is specified in a broadcast transmission, hyperlink e-mail transmission will not take place.
- If you frequently use broadcasting to send images to the same group of destinations, it is convenient to store those destinations in a group key.

4

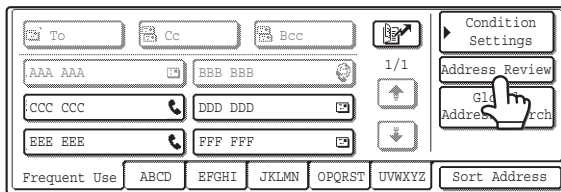

### Touch the [Address Review] key in the Address Book screen.

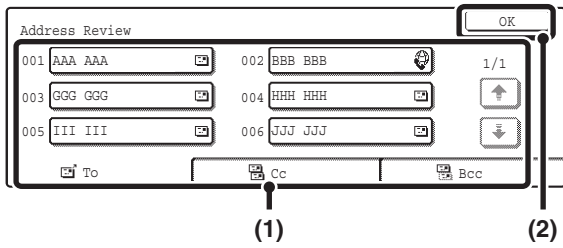

## Check the destinations.

- (1) Check the destinations.
- (2) Touch the [OK] key.



If the transmission includes Cc or Bcc destinations, touch the [Cc] tab or the [Bcc] tab to check those destinations.



### To cancel a specified destination...

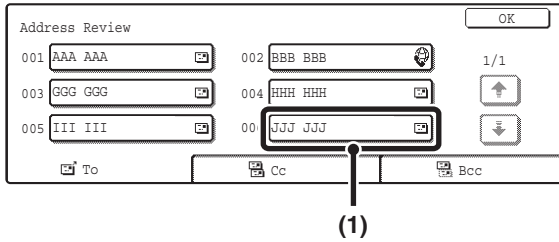

- (1) Touch the key of the destination that you wish to cancel.

- (2) Touch the [Yes] key.

If you do not wish to cancel the destination, touch the [No] key.

- (3) Touch the [OK] key.

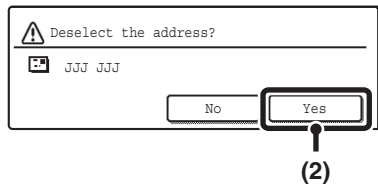

(2)

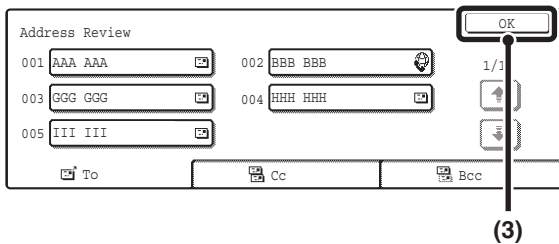

(3)

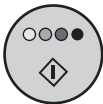

or



## Press the [COLOR START] key (○●●●) or the [BLACK & WHITE START] key (○●).

Scanning begins.

- If you inserted the original pages in the document feeder tray, all pages are scanned.  
A beep will sound to indicate that scanning is finished.
- If you are scanning the original on the document glass, scan each page one page at a time.  
When scanning of one page finishes, replace it with the next page and press the [COLOR START] key (○●●●) or the [BLACK & WHITE START] key (○●). Repeat until all pages have been scanned and then press the [Read-End] key.  
A beep will sound to indicate that scanning is finished.



If fax or Internet fax destinations are included in the broadcast transmission, the [COLOR START] key (○●●●) cannot be pressed. Scanning will take place in Mono 2.



### To cancel scanning...

Press the [STOP] key (⊘) to cancel the operation.

# BROADCAST TRANSMISSIONS THAT INCLUDE INTERNET FAX DESTINATIONS

When a broadcast transmission includes both scan mode and Internet fax mode destinations, the Internet fax mode settings (original orientation and other settings) are given priority. When performing this type of broadcast transmission, note the information below.

<b>Original placement orientation</b>	The orientation of Internet fax mode is given priority. When "Rotation Sending Setting" is enabled in the system settings (administrator), the image is rotated 90 degrees. For this reason, in some cases the image may not be displayed in the correct orientation.	
<b>Send size</b>	When the file format is set to [TIFF-S] in Internet fax mode, transmission is only possible in 8-1/2" x 11"R (A4R) size.	
<b>Exposure</b>	The Internet fax settings are given priority.	
<b>Resolution</b>	When the file format is set to [TIFF-S] in Internet fax mode and a high resolution setting is selected in scan mode, the resolution will be changed to [200x200dpi].	
<b>File compression mode</b>	The compression mode will be changed to the compression mode set in "Compression Mode at Broadcasting" in the system settings (administrator).	
<b>Color scanning</b>	Scanning will take place in Mono 2 regardless of the color mode setting.	
<b>Special modes</b>	<b>2in1</b>	This cannot be selected in scan mode, however, if selected in Internet fax mode, it will also be applied to scan destinations.
<b>Scan file size</b>	If a broadcast transmission is performed that includes destinations (Scan to E-mail, Scan to FTP, Scan to Desktop, Scan to Network Folder, or Internet fax) for which an attachment size limit has been set using "Maximum Size of E-mail Attachments" in the system settings (administrator), the limit will also apply to destinations for which a limit is not set. (The limitation setting of Scan to E-mail or Internet fax is given priority.)	

# Resending to unsuccessful broadcast transmission destinations

The results of a completed broadcast transmission can be checked in the job status screen. If transmission to any of the addresses failed, resend the image to those addresses.

1



**JOB STATUS**

**Press the [JOB STATUS] key.**

2

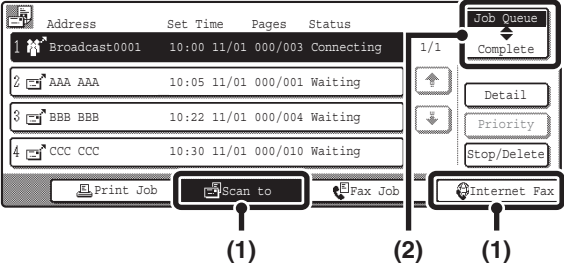

**Display the jobs completed screen.**

- (1) Touch the key of the mode that you wish to display.
- (2) Touch the [Complete] key.

 If the broadcast transmission included destinations of different modes, the same broadcast transmission key will appear in each of those modes.

3

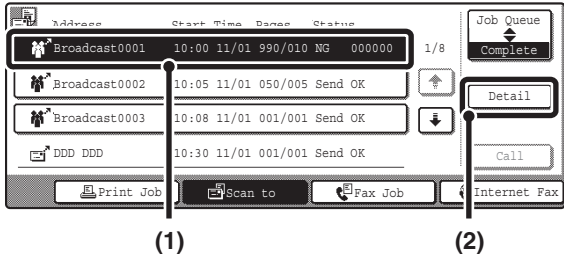

**Display details on the broadcast transmission.**

- (1) Touch the key of the completed broadcast transmission.
- (2) Touch the [Detail] key.

 "Broadcastxxxx" will appear as the address of the broadcast job key. The job control number that appeared in the touch panel when scanning ended appears in "xxxx".

4

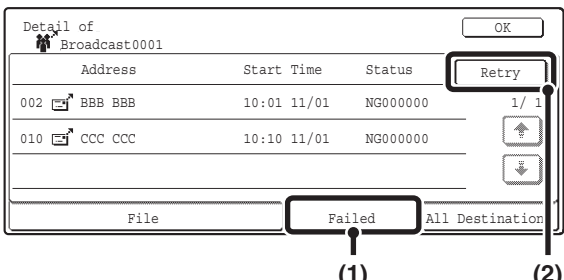

**Resend the image to the unsuccessful destinations.**

- (1) Touch the [Failed] tab.
- (2) Touch the [Retry] key.

-  Operation after the [Retry] key is touched differs depending on whether or not the document filing function is used.
- Not using document filing**  
You will return to the base screen with the unsuccessful destinations entered. Place the original and perform the steps of the broadcast transmission.
  - Using document filing**  
You will return to the document filing resend screen with the unsuccessful destinations entered. Perform the document filing resend procedure. (There is no need to rescan the original.)
  - If the [All Destinations] tab is touched in (1), all of the destinations will be displayed. The [Retry] key that appears in the screen can be touched to resend to all the destinations.

# ERASING PERIPHERAL SHADOWS ON THE IMAGE (Erase)

The erase function is used to erase shadow lines on images produced when scanning thick originals or books on the document glass. (This function erases the parts of the image where shadows tend to form. The function does not detect shadows and erase only the shadows.)

## Scanning a thick book

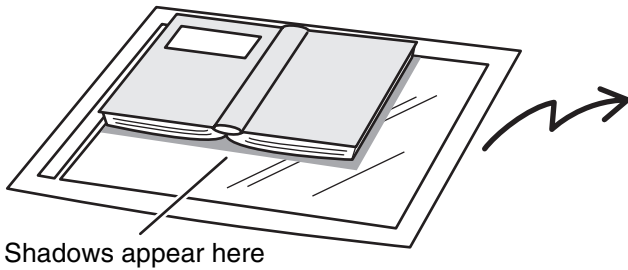

Not using the erase function	Using the erase function
<p>Shadows appear in the image.</p>	<p>No shadows appear.</p>

## Erase modes

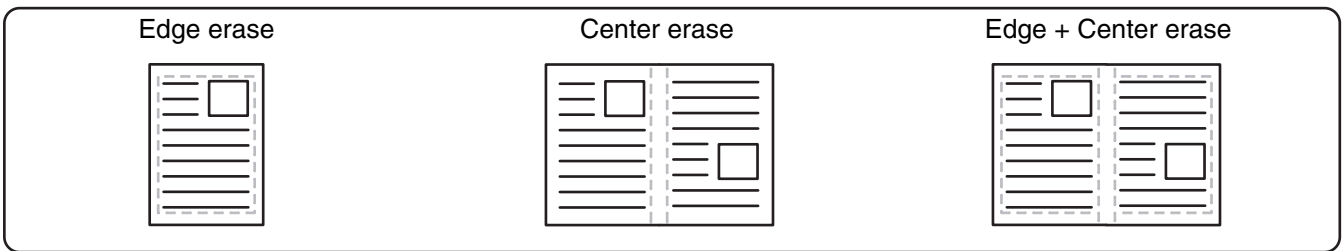

- Shadows at the edges of the original can also be erased when the automatic document feeder is used.
- When using USB memory mode, connect the USB memory device to the machine before performing the procedure below.

1

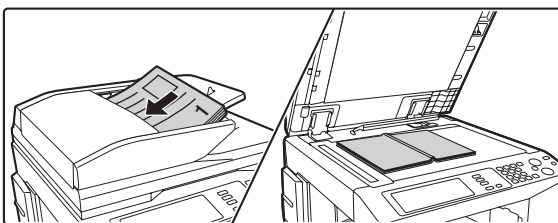

## Place the original.

Place the original face up in the document feeder tray, or face down on the document glass.

2

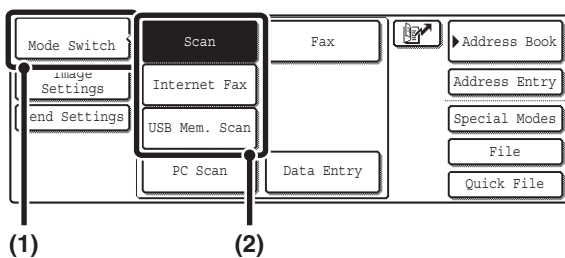

## Select the mode that you wish to use.

- (1) Touch the [Mode Switch] key.
- (2) Touch the key of the mode that you wish to use.

3

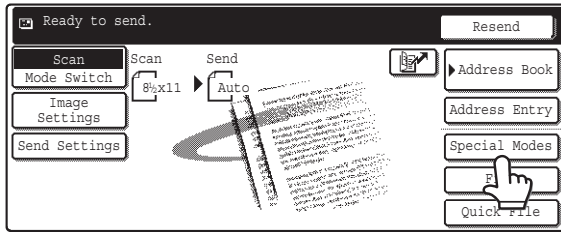

Touch the [Special Modes] key.

4

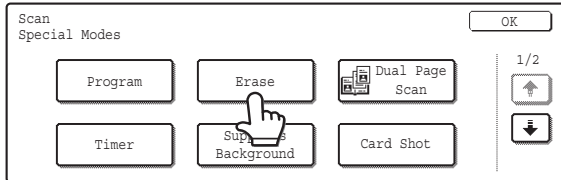

Touch the [Erase] key.

5

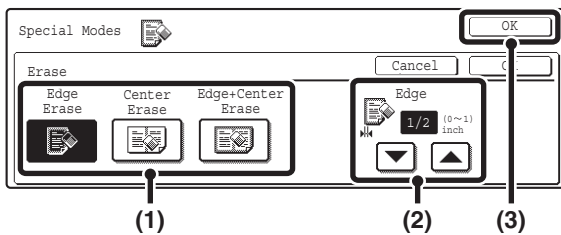

Select the erase settings.

(1) Touch the desired erase mode.

Select one of the three erase modes.

(2) Set the erasure width with the  $\downarrow$   $\uparrow$  keys.

0" to 1" (0 mm to 20 mm) can be entered.

(3) Touch the [OK] key.



Touch the [OK] key next to the [Cancel] key to complete the setting and return to the screen of step 4.

6

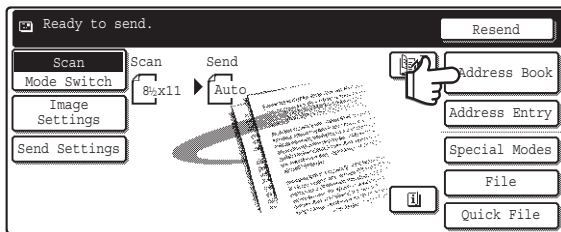

Touch the [Address Book] key.

To directly enter a destination address, touch the [Address Entry] key.

[ENTER THE ADDRESS MANUALLY](#) (page 23)



- When scanning to USB memory, there is no need to specify the destination. Go to step 8.
- You can touch the key to display a list of the selected special mode settings or two-sided scanning. To return to the previous screen after checking the settings, touch the [OK] key.

7

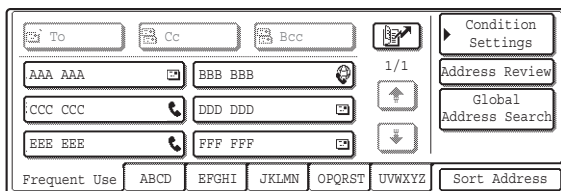

Specify the destination.

- Touch the one-touch key for the desired destination and then the [To] key.

[SPECIFYING DESTINATIONS IN THE ADDRESS BOOK](#) (page 19)

- To specify a destination address in a global address book, touch the [Global Address Search] key and specify the address.

[CALLING UP A DESTINATION FROM A GLOBAL ADDRESS BOOK](#) (page 24)

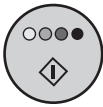

or

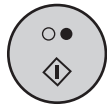

Press the [COLOR START] key (○●●●) or the [BLACK & WHITE START] key (○●).

Scanning begins.

- If you inserted the original pages in the document feeder tray, all pages are scanned. A beep will sound to indicate that scanning is finished.
- If you are scanning the original on the document glass, scan each page one page at a time. When scanning of one page finishes, replace it with the next page and press the [COLOR START] key (○●●●) or the [BLACK & WHITE START] key (○●). Repeat until all pages have been scanned and then press the [Read-End] key. A beep will sound to indicate that scanning is finished.



If the destination is an Internet fax destination, press the [BLACK & WHITE START] key (○●).



**To cancel scanning...**

Press the [STOP] key (⊞) to cancel the operation.



When the erase function is used, erase takes place at the edges of the original image. If you also use a reduction or an enlargement setting, the erase width will change according to the selected ratio. For example, if the erase width setting is 1" (20 mm) and the image is reduced to 50%, the erase width will be 1/2" (10 mm).



**To cancel the erase setting...**

Touch the [Cancel] key in the screen of step 5.



**System Settings (Administrator): Erase Width Adjustment**

The default erase width setting is linked to the copy mode system setting, and can be set from 0" to 1" (0 mm to 20 mm). The factory default setting is 1/2" (10 mm).

# SCANNING AN ORIGINAL AS TWO SEPARATE PAGES (Dual Page Scan)

The left and right sides of an original can be scanned as two separate pages. This function is useful when you wish to successively scan each page of a book or other bound document.

## Example: Scanning the left and right pages of a book



Book or bound document

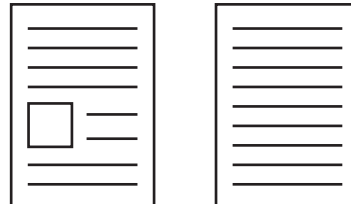

The pages are scanned as two separate pages.

Original scan size	Transmitted image
11" x 17" (A3) x 1 page	8-1/2" x 11" (A4) x 2 pages

- When using dual page scan, the original must be placed on the document glass.
- The send size cannot be changed.
- When using USB memory mode, connect the USB memory device to the machine before performing the procedure below.

1

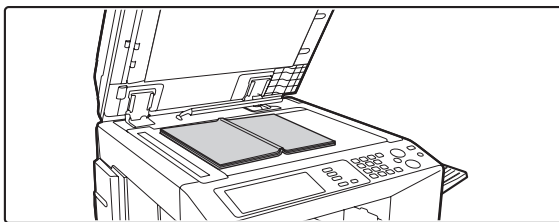

Place the original face down on the document glass.

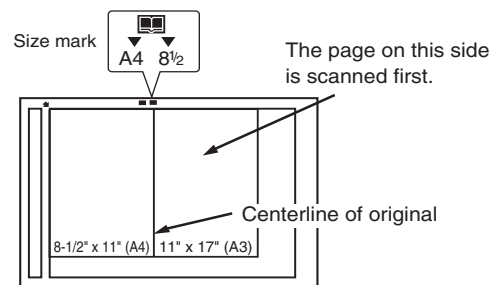

Place the original with the page that you wish to scan first on the right on the document glass. Align the centerline of the original with the size mark.

2

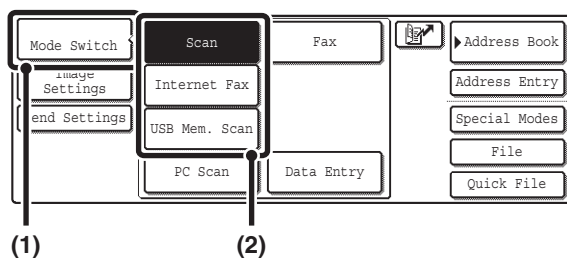

Select the mode that you wish to use.

- (1) Touch the [Mode Switch] key.
- (2) Touch the key of the mode that you wish to use.



3

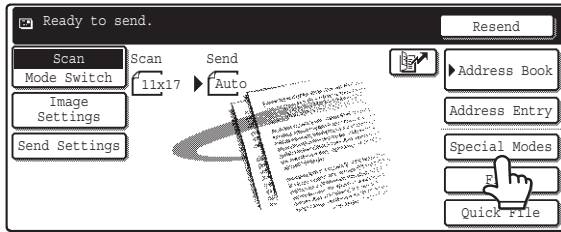

Touch the [Special Modes] key.

4

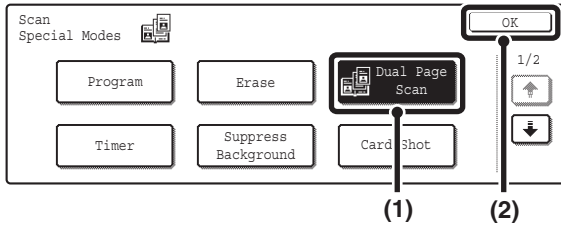

Select Dual Page Scan.

- (1) Press the [Dual Page Scan] key so that it is highlighted.
- (2) Touch the [OK] key.

5

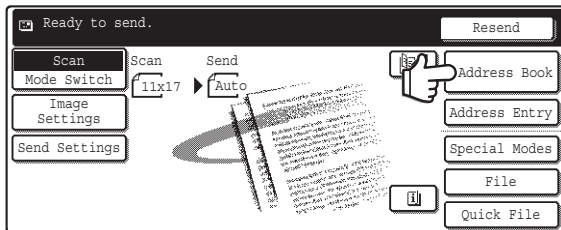

Touch the [Address Book] key.

To directly enter a destination address, touch the [Address Entry] key.

- ✎ [ENTER THE ADDRESS MANUALLY](#) (page 23)



- When scanning to USB memory, there is no need to specify the destination. Go to step 7.
- You can touch the  key to display a list of the selected special mode settings or two-sided scanning. To return to the previous screen after checking the settings, touch the [OK] key.

6

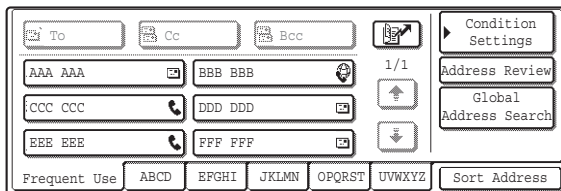

Specify the destination.

- Touch the one-touch key of the desired destination and then the [To] key.
  - ✎ [SPECIFYING DESTINATIONS IN THE ADDRESS BOOK](#) (page 19)
- To specify a destination address in a global address book, touch the [Global Address Search] key and specify the address.
  - ✎ [CALLING UP A DESTINATION FROM A GLOBAL ADDRESS BOOK](#) (page 24)

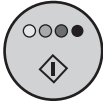

or



Press the [COLOR START] key (○●●●) or the [BLACK & WHITE START] key (○●).

Scanning begins.

When scanning finishes, place the next two open pages and press the [COLOR START] key (○●●●) or the [BLACK & WHITE START] key (○●). Repeat until all pages have been scanned and then press the [Read-End] key.

A beep will sound to indicate that scanning is finished.



If the destination is an Internet fax destination, press the [BLACK & WHITE START] key (○●).



**To cancel scanning...**

Press the [STOP] key (⊘) to cancel the operation.



To erase shadows caused by the binding of a book or other bound document, use the erase function. (Center Erase and Edge + Center Erase cannot be used together.)



**To cancel the dual page scan setting...**

Touch the [Dual Page Scan] key in the screen of step 4 so that it is no longer highlighted, and touch the [OK] key.

# SENDING AN IMAGE AT A SPECIFIED TIME (Timer Transmission)

This function lets you specify a time at which a transmission or broadcast transmission will automatically take place. Transmission begins automatically at the specified time.

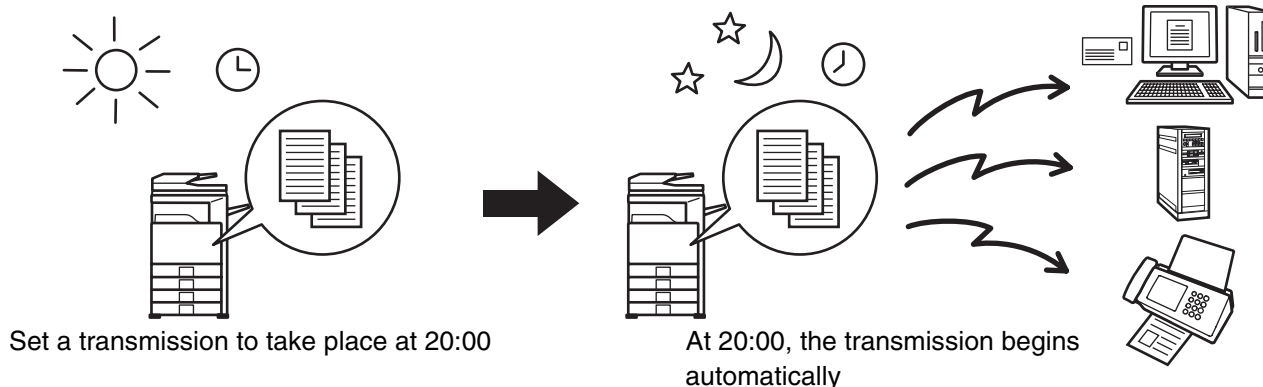

- When a timer transmission is stored, keep the main power switch in the "on" position. If the main power switch is in the "off" position at the specified time, transmission will not take place.
- When performing a timer transmission, you must scan the original into memory when you set up the transmission. It is not possible to leave the document in the auto document feeder or on the document glass and have it scanned at the specified time of transmission.
- Settings selected for a timer transmission (exposure, resolution, special modes, etc.) are automatically cleared after the transmission is finished. (However, when the document filing function is used, the scanned original and settings are stored on the built-in hard drive. For more information on the document filing function, see the Document Filing Guide.)
- This function cannot be used in USB memory mode.

1

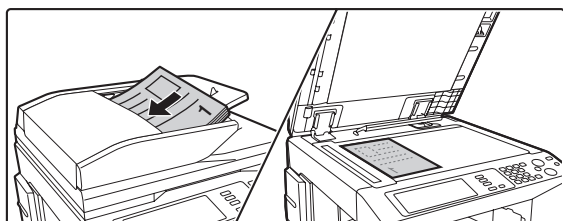

## Place the original.

Place the original face up in the document feeder tray, or face down on the document glass.

2

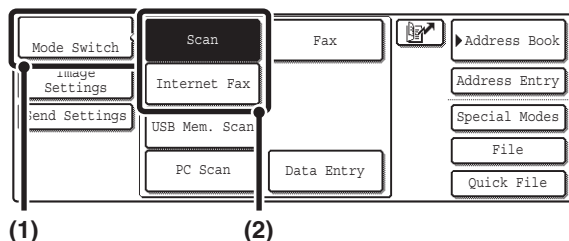

## Select the mode that you wish to use.

- (1) Touch the [Mode Switch] key.
- (2) Touch the key of the mode that you wish to use.

3

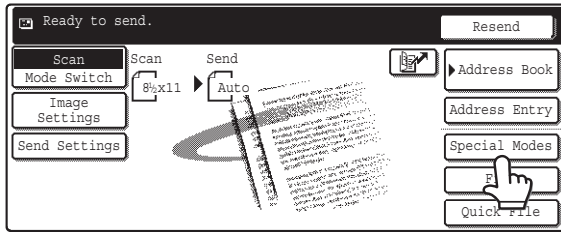

Touch the [Special Modes] key.

4

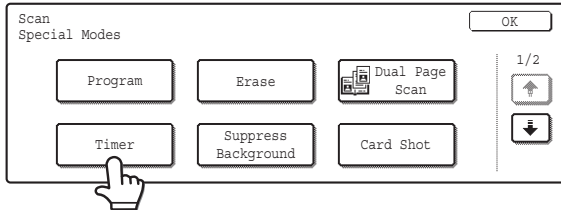

Touch the [Timer] key.

5

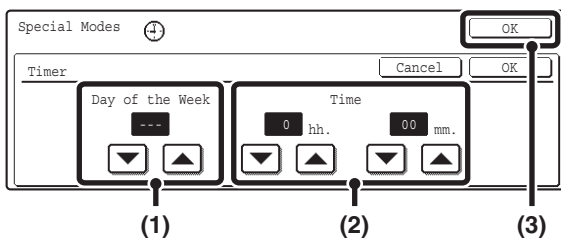

Set the time with the keys.

**(1) Specify the day.**

If you do not wish to specify a day, select [---]. In this case, transmission will begin when the time specified in (2) arrives.

**(2) Specify the time (hour, minute)**

Select the time in 24-hour format.

**(3) Touch the [OK] key.**



- When this screen is opened, the setting will show the current time. If the time is not correct, press the [CLEAR ALL] key () to cancel the operation. Correct the time in the system settings and then perform the timer transmission procedure.

[CHECKING THE DATE AND TIME](#) (page 6)

- Touch the [OK] key next to the [Cancel] key to complete the setting and return to the screen of step 4.

6

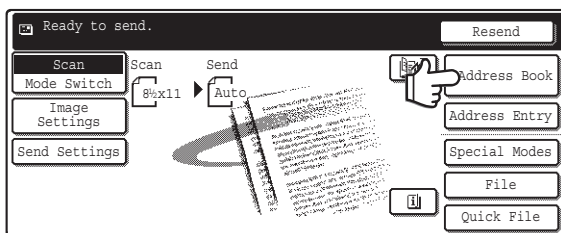

Touch the [Address Book] key.

To directly enter a destination address, touch the [Address Entry] key.

[ENTER THE ADDRESS MANUALLY](#) (page 23)



You can touch the key to display a list of the selected special mode settings or two-sided scanning. To return to the previous screen after checking the settings, touch the [OK] key.

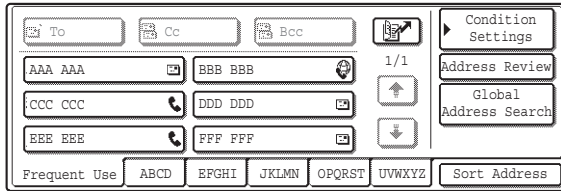

## Specify the destination.

- Touch the one-touch key for the desired destination and then the [To] key.
  - [SPECIFYING DESTINATIONS IN THE ADDRESS BOOK](#) (page 19)
- To specify a destination address in a global address book, touch the [Global Address Search] key and specify the address.
  - [CALLING UP A DESTINATION FROM A GLOBAL ADDRESS BOOK](#) (page 24)

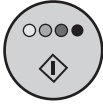

or



## Press the [COLOR START] key (○●●●) or the [BLACK & WHITE START] key (○●).

Scanning begins.

- If you inserted the original pages in the document feeder tray, all pages are scanned. A beep will sound to indicate that scanning is finished.
- If you are scanning the original on the document glass, scan each page one page at a time. When scanning finishes, place the next original and press the [COLOR START] key (○●●●) or the [BLACK & WHITE START] key (○●). Repeat until all pages have been scanned and then press the [Read-End] key. A beep will sound to indicate that scanning is finished.



- If the destination is an Internet fax destination, press the [BLACK & WHITE START] key (○●).
- The original is scanned into memory. The original cannot be scanned at a specified time.



- The time can be specified up to a week in advance.
- Up to 94 timer transmissions can be stored at once.
- If another transmission is in progress when the specified time arrives, the timer transmission will begin after that transmission is finished.
- Other transmissions can be performed as usual after a timer transmission is stored.
- A timer transmission can be deleted in the job status screen.
- If a timer transmission is given priority in the job status screen, the time specification is canceled. The transmission will begin as soon as the job in progress is completed.

# WHITENING FAINT COLORS IN THE IMAGE (Suppress Background)

This feature is used to suppress light background areas.

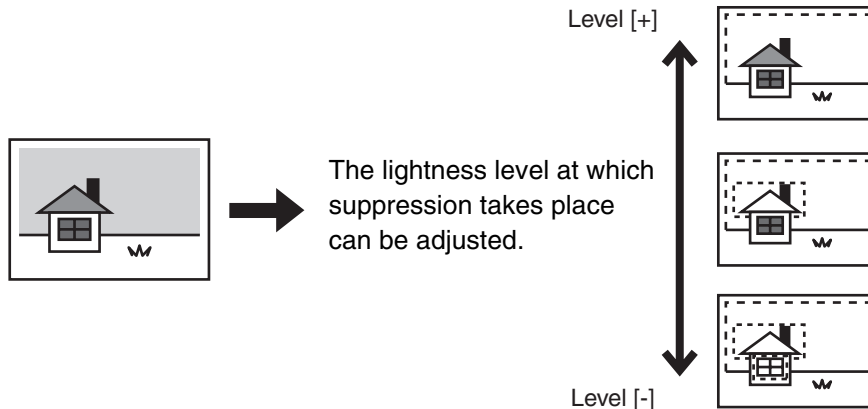

- This function cannot be used in Internet fax mode.
- When using USB memory mode, connect the USB memory device to the machine before performing the procedure below.

1

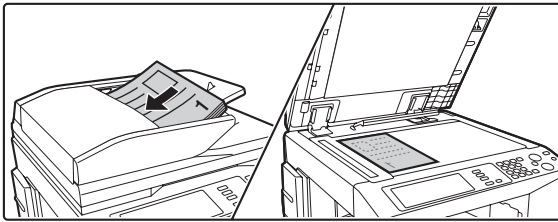

## Place the original.

Place the original face up in the document feeder tray, or face down on the document glass.

2

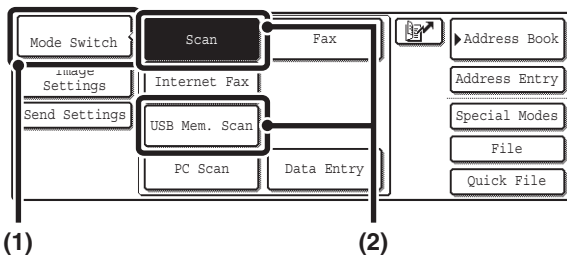

## Select the mode that you wish to use.

- (1) Touch the [Mode Switch] key.
- (2) Touch the key of the mode that you wish to use.

3

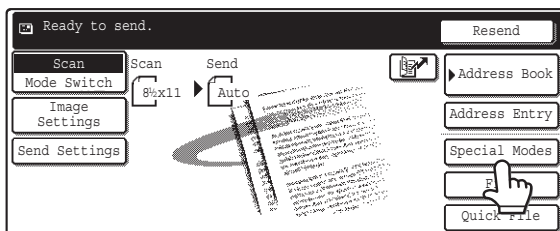

## Touch the [Special Modes] key.

4

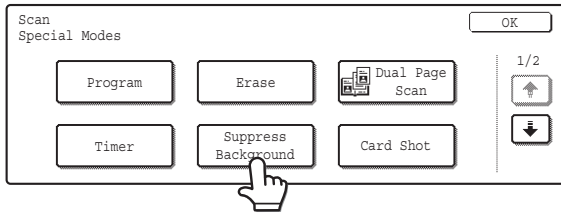

## Touch the [Suppress Background] key.

Read the message that appears and then touch the [OK] key.

5

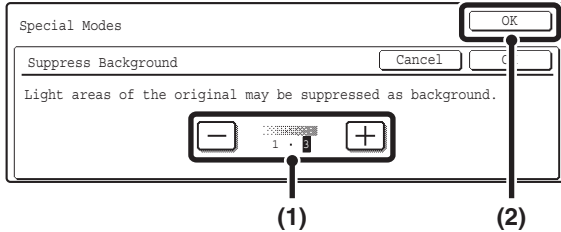

## Select the suppress background setting.

### (1) Adjust the background suppression level.

Three levels are available for the contrast. Touch the key to make the background lighter, or the key to make the background darker.

### (2) Touch the [OK] key.



Touch the [OK] key next to the [Cancel] key to complete the setting and return to the screen of step 4.

6

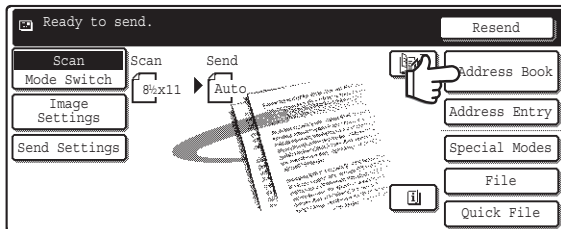

## Touch the [Address Book] key.

To directly enter a destination address, touch the [Address Entry] key.

[ENTER THE ADDRESS MANUALLY](#) (page 23)



- When scanning to USB memory, there is no need to specify the destination. Go to step 8.
- You can touch the key to display a list of the selected special mode settings or two-sided scanning. To return to the previous screen after checking the settings, touch the [OK] key.

7

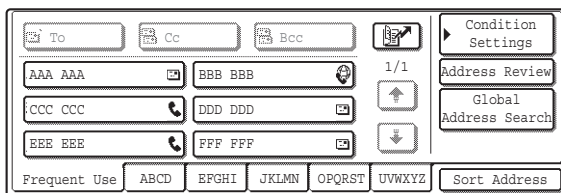

## Specify the destination.

- Touch the one-touch key for the desired destination and then the [To] key.

[SPECIFYING DESTINATIONS IN THE ADDRESS BOOK](#) (page 19)

- To specify a destination address in a global address book, touch the [Global Address Search] key and specify the address.

[CALLING UP A DESTINATION FROM A GLOBAL ADDRESS BOOK](#) (page 24)



or



Press the **[COLOR START] key** (○●●●) or the **[BLACK & WHITE START] key** (○●).

Scanning begins.

- If you inserted the original pages in the document feeder tray, all pages are scanned. A beep will sound to indicate that scanning is finished.
- If you are scanning the original on the document glass, scan each page one page at a time. When scanning finishes, place the next original and press the [COLOR START] key (○●●●) or the [BLACK & WHITE START] key (○●). Repeat until all pages have been scanned and then press the [Read-End] key. A beep will sound to indicate that scanning is finished.



If the color mode setting of the [BLACK & WHITE START] key (○●) is [Mono2], the suppress background function will not operate if the [BLACK & WHITE START] key (○●) is pressed.



**To cancel scanning...**

Press the [STOP] key (⏏) to cancel the operation.



**To cancel the background suppression setting...**

Touch the [Cancel] key in the screen of step 5.



# SCANNING BOTH SIDES OF A CARD ONTO A SINGLE PAGE (Card Shot)

This function lets you send the front and reverse sides of a card as a single page, without the need to send each side separately.

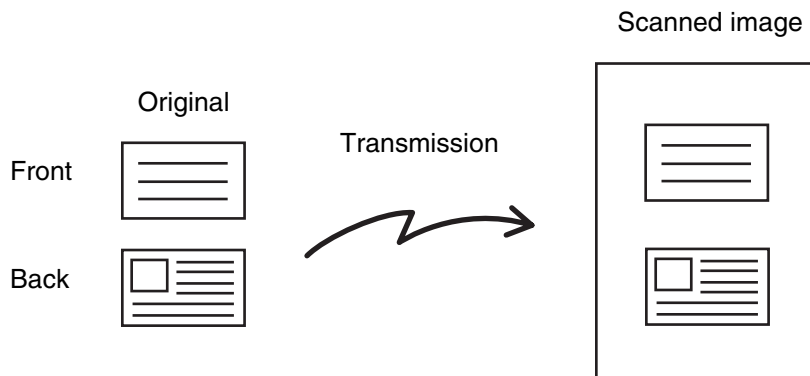

- When using card shot, the original must be placed on the document glass.
- When using USB memory mode, connect the USB memory device to the machine before performing the procedure below.

1

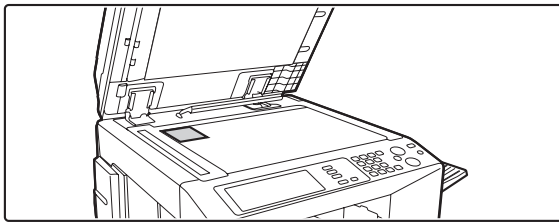

Place the original face down on the document glass.

2

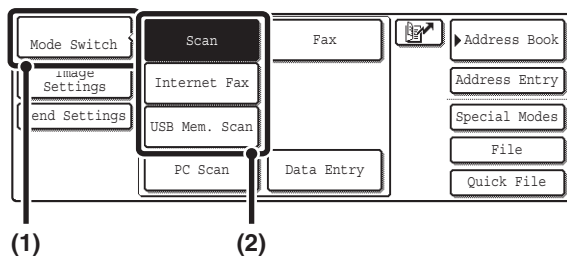

Select the mode that you wish to use.

- (1) Touch the [Mode Switch] key.
- (2) Touch the key of the mode that you wish to use.

3



Touch the [Special Modes] key.

4

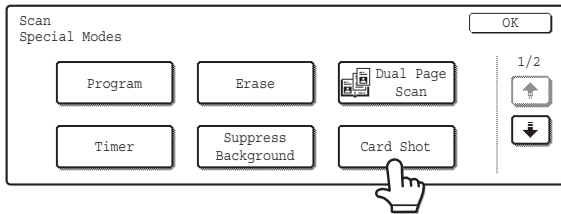

Touch the [Card Shot] key.

5

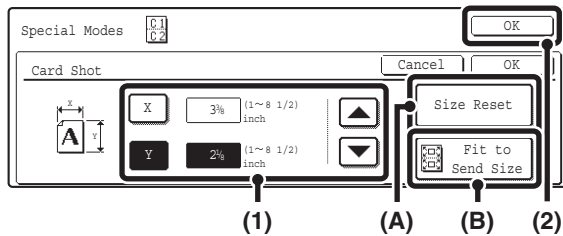

Specify the original size.

(1) Enter the original size.

- Touch the [X] key and enter the horizontal dimension (X) of the original with the  $\blacktriangledown$   $\blacktriangle$  keys.
- Touch the [Y] key and enter the vertical dimension (Y) of the original with the  $\blacktriangledown$   $\blacktriangle$  keys.
- (A) To return the original size to the default size, touch the [Size Reset] key.
- (B) To automatically enlarge or reduce the image to fit the send size, touch the [Fit to Send Size] key. If you wish to scan the original at the entered original size, there is no need to touch this key.

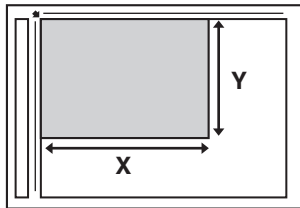

(2) Touch the [OK] key.



- The send size will be selected automatically based on the entered original size. The send size can be changed manually.
- Touch the [OK] key next to the [Cancel] key to complete the setting and return to the screen of step 4.

6

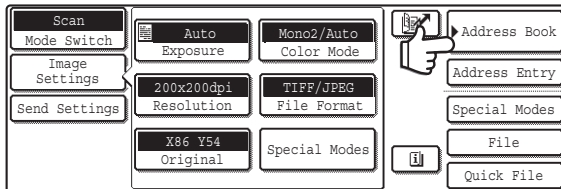

Touch the [Address Book] key.

To directly enter a destination address, touch the [Address Entry] key.

**ENTER THE ADDRESS MANUALLY** (page 23)



- To change the original scan size or send size, touch the [Original] key. When the [Original] key is touched, the following screen appears.

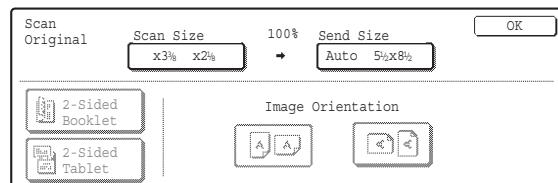

Touch the "Scan Size" key to display the screen of step 5. Touch the "Send Size" key to display the send size selection screen.

- When scanning to USB memory, there is no need to specify the destination. Go to step 8.
- You can touch the key to display a list of the selected special mode settings or two-sided scanning. To return to the previous screen after checking the settings, touch the [OK] key.

7

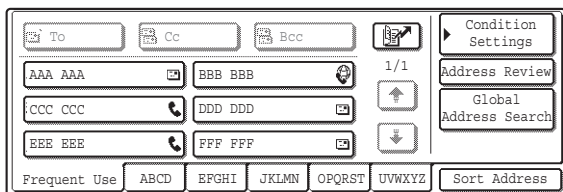

## Specify the destination.

- Touch the one-touch key for the desired destination and then the [To] key.
  - [SPECIFYING DESTINATIONS IN THE ADDRESS BOOK](#) (page 19)
- To specify a destination address in a global address book, touch the [Global Address Search] key and specify the address.
  - [CALLING UP A DESTINATION FROM A GLOBAL ADDRESS BOOK](#) (page 24)

8

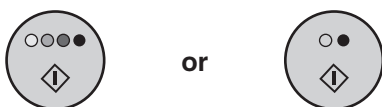

Press the [COLOR START] key (○●●●) or the [BLACK & WHITE START] key (○●) to scan the front side of the card.



If the destination is an Internet fax destination, press the [BLACK & WHITE START] key (○●).

9

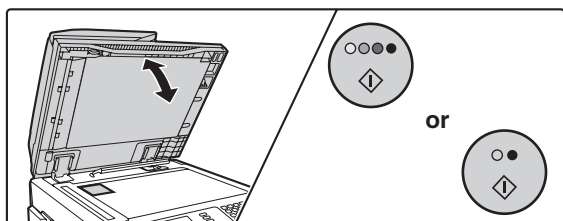

Turn the card over and press the [COLOR START] key (○●●●) or the [BLACK & WHITE START] key (○●) to scan the reverse side of the card.

Press the same [START] key that was used to scan the front side.

10

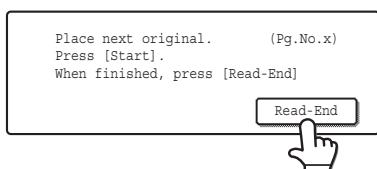

Touch the [Read-End] key in the touch panel.



The ratio cannot be specified and the Rotation Sending Setting cannot be selected.



**To cancel the card shot...**

Touch the [Cancel] key in the screen of step 5.

# SCANNING MANY ORIGINALS AT ONCE (Job Build)

When you have a large number of originals to transmit, this function lets you separate the originals into sets. The sets are scanned in the automatic document feeder one set at a time and then sent together as a single transmission. Use this function when the number of originals that you wish to scan exceeds the maximum number of sheets (100 sheets) that can be inserted in the automatic document feeder at once.

When scanning originals that are separated into sets, scan the set that has the first page first. The settings that you select for the first set can be used for all remaining sets.

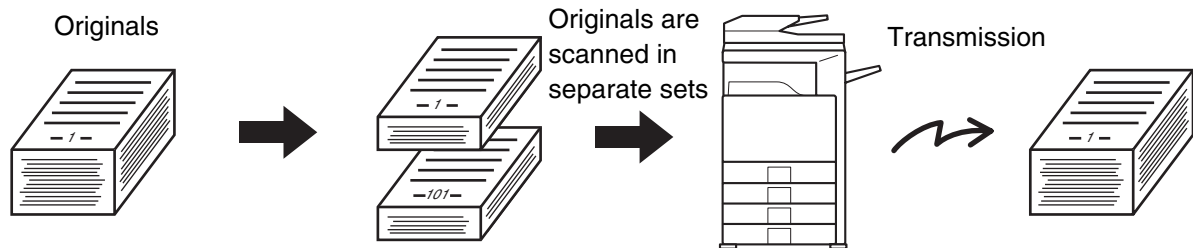

 When using USB memory mode, connect the USB memory device to the machine before performing the procedure below.

1

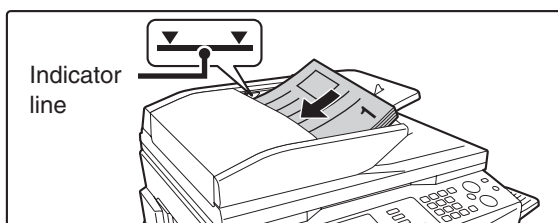

## Insert the originals face up in the document feeder tray.

Place the originals face up. Insert the originals all the way into the document feeder tray. The stack must not be higher than the indicator line (no more than 100 sheets).

2

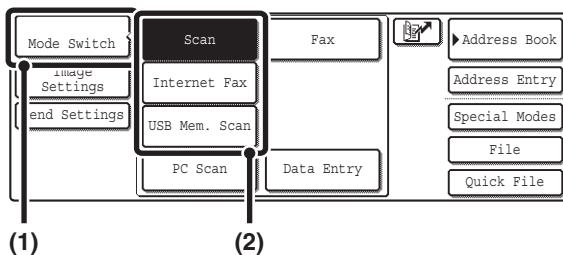

## Select the mode that you wish to use.

- (1) Touch the [Mode Switch] key.
- (2) Touch the key of the mode that you wish to use.

3

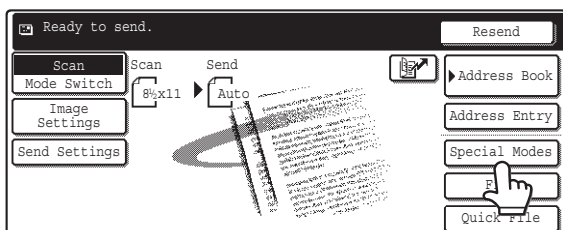

## Touch the [Special Modes] key.

4

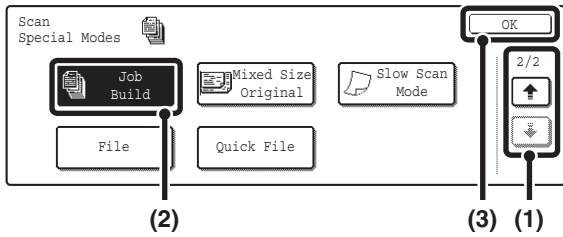

## Select job build mode.

- (1) Touch the keys to switch through the screens.  
If you selected Internet fax mode, go to the 3rd screen.
- (2) Touch the [Job Build] key so that it is highlighted.
- (3) Touch the [OK] key.

5

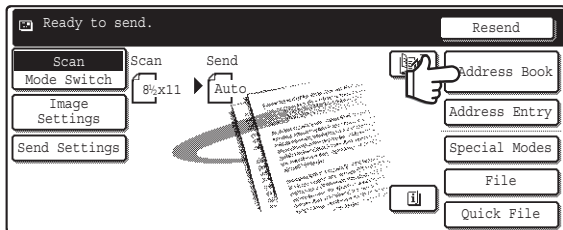

## Touch the [Address Book] key.

To directly enter a destination address, touch the [Address Entry] key.

[ENTER THE ADDRESS MANUALLY](#) (page 23)



- When scanning to USB memory, there is no need to specify the destination. Go to step 7.
- You can touch the key to display a list of the selected special mode settings or two-sided scanning. To return to the previous screen after checking the settings, touch the [OK] key.

6

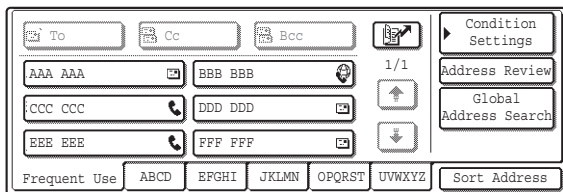

## Specify the destination.

- Touch the one-touch key for the desired destination and then the [To] key.  
 [SPECIFYING DESTINATIONS IN THE ADDRESS BOOK](#) (page 19)
- To specify a destination address in a global address book, touch the [Global Address Search] key and specify the address.  
 [CALLING UP A DESTINATION FROM A GLOBAL ADDRESS BOOK](#) (page 24)

7

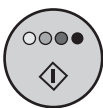

or



Press the [COLOR START] key (○●●●) or the [BLACK & WHITE START] key (○●) to scan the first set of originals.



If the destination is an Internet fax destination, press the [BLACK & WHITE START] key (○●) in the touch panel.



### To cancel scanning...

Press the [STOP] key (⊘) to cancel the operation. All scanned data will be cleared.

8

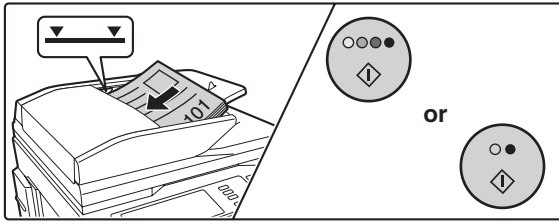

Insert the next set of originals and press the [COLOR START] key (○●●●) or the [BLACK & WHITE START] key (○●).

Press the [START] key pressed in step 7.  
Repeat until all originals have been scanned.



The exposure and resolution can be changed between sets of originals.

9

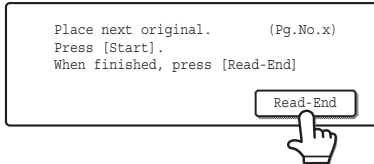

Touch the [Read-End] key in the touch panel.



If no action is taken for one minute after the confirmation screen appears, scanning automatically ends and the transmission is reserved.



If the memory becomes full during scanning, a message will appear and the transmission will be canceled.



**To cancel the job build function....**

Touch the [Job Build] key in the screen of step 4 so that it is not highlighted.

# SCANNING ORIGINALS OF DIFFERENT SIZES (Mixed Size Original)

This feature lets you scan originals of different sizes at the same time; for example, 8-1/2" x 14" (B4) size originals mixed together with 11" x 17" (A3) size originals. When scanning the originals, the machine automatically detects the size of each original.

## Originals

(8-1/2" x 14" (B4) original mixed in with 11" x 17" (A3) originals)

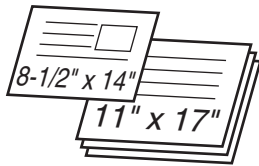

## Files created

1st page

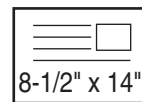

Scanned in at 8-1/2" x 14" (B4) size

2nd to 4th pages

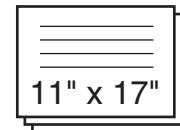

Scanned in at 11" x 17" (A3) size

This feature can only be used with the following combinations of original sizes:

11" x 17" and 8-1/2" x 14", 11" x 17" and 8-1/2" x 13", 11" x 17" and 5-1/2" x 8-1/2"

(A3 and B4, A3 and B5, A4 and B4, A4 and B5, A4R and B5, B4 and A4R, B4 and A5, B5 and A5)

When using USB memory mode, connect the USB memory device to the machine before performing the procedure below.

1

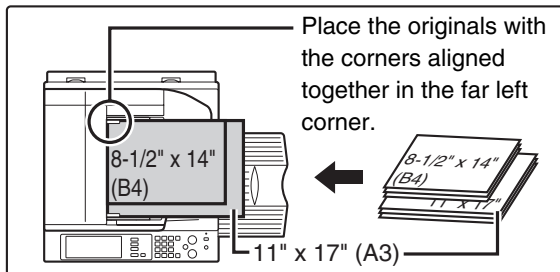

## Insert the originals face up in the document feeder tray.

Insert the originals with the corners aligned together in the far left corner of the document feeder tray.

The following combinations of sizes of originals can be placed together in the document feeder tray: 11" x 17" and 8-1/2" x 14", 11" x 17" and 8-1/2" x 13", 11" x 17" and 5-1/2" x 8-1/2" (A3 and B4, A3 and B5, A4 and B4, A4 and B5, A4R and B5, B4 and A4R, B4 and A5, B5 and A5)

2

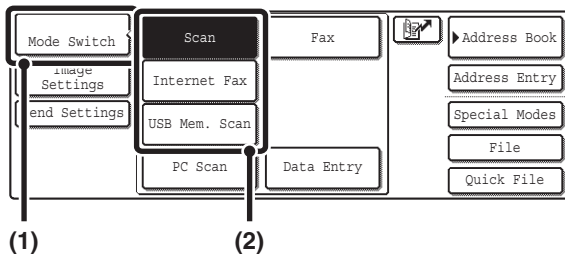

## Select the mode that you wish to use.

- (1) Touch the [Mode Switch] key.
- (2) Touch the key of the mode that you wish to use.

3

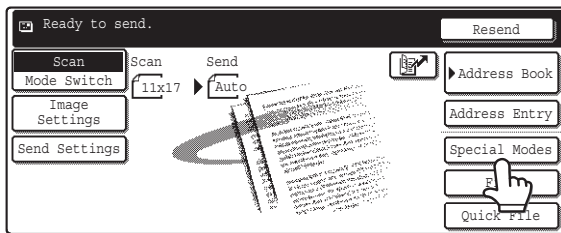

Touch the [Special Modes] key.

4

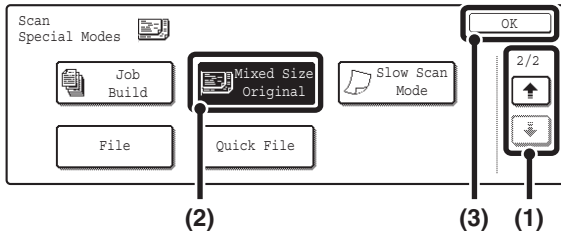

Select the mixed size original setting.

(1) Touch the keys to switch through the screens.

If you selected Internet fax mode, go to the 3rd screen.

(2) Touch the [Mixed Size Original] key so that it is highlighted.

(3) Touch the [OK] key.



If an original scan size has been specified, a message will appear when the [Mixed Size Original] key is touched. To enable the Mixed Size Original setting, change the scan size setting to auto and then touch the [Mixed Size Original] key again.

5

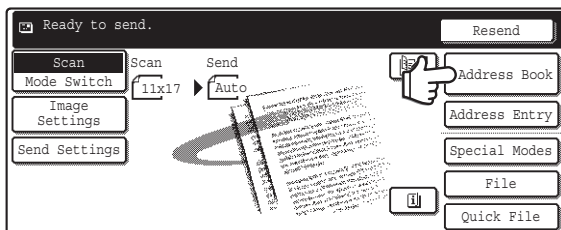

Touch the [Address Book] key.

To directly enter a destination address, touch the [Address Entry] key.

[ENTER THE ADDRESS MANUALLY](#) (page 23)



- When scanning to USB memory, there is no need to specify the destination. Go to step 7.
- You can touch the key to display a list of the selected special mode settings or two-sided scanning. To return to the previous screen after checking the settings, touch the [OK] key.

6

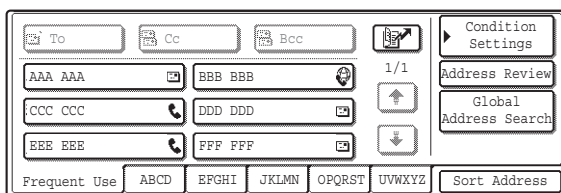

Specify the destination.

- Touch the one-touch key for the desired destination and then the [To] key.

[SPECIFYING DESTINATIONS IN THE ADDRESS BOOK](#) (page 19)

- To specify a destination address in a global address book, touch the [Global Address Search] key and specify the address.

[CALLING UP A DESTINATION FROM A GLOBAL ADDRESS BOOK](#) (page 24)



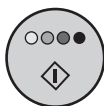

or



Press the [COLOR START] key (○●●●) or the [BLACK & WHITE START] key (○●).

Scanning begins. A beep will sound to indicate that scanning is finished.



If the destination is an Internet fax destination, press the [BLACK & WHITE START] key (○●).



**To cancel scanning...**

Press the [STOP] key (⊞) to cancel the operation.



- If an original scan size is specified after selecting the Mixed Size Original setting, the original scan size setting will be enabled and the Mixed Size Original setting will be cleared.
- When the Mixed Size Original setting is selected, automatic two-sided copying cannot be used.



**To cancel the mixed size original setting...**

Touch the [Mixed Size Original] key in the screen of step 4 so that it is not highlighted.





**System Settings (Administrator): Original Feeding Mode**

The original feeding mode can be set to always scan mixed size originals.

# SCANNING THIN ORIGINALS (Slow Scan Mode)

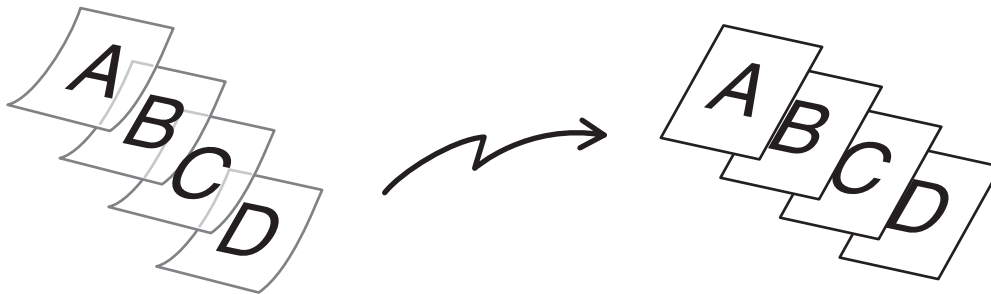
Use this function when you wish to scan thin originals using the automatic document feeder. This function helps prevent thin originals from misfeeding.



 When using USB memory mode, connect the USB memory device to the machine before performing the procedure below.

1

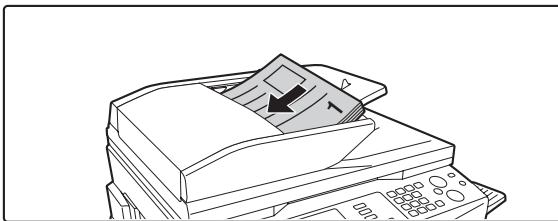

**Insert the originals face up in the document feeder tray.**

Adjust the original guides slowly.

 If the originals are inserted with too much force, they may crumple and misfeed.

2

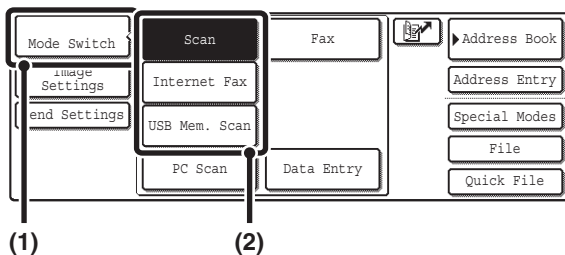

**Select the mode that you wish to use.**

(1) Touch the [Mode Switch] key.

(2) Touch the key of the mode that you wish to use.

3

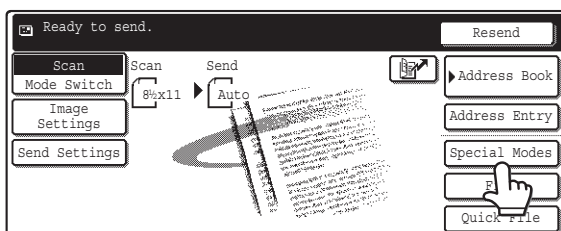

**Touch the [Special Modes] key.**

4

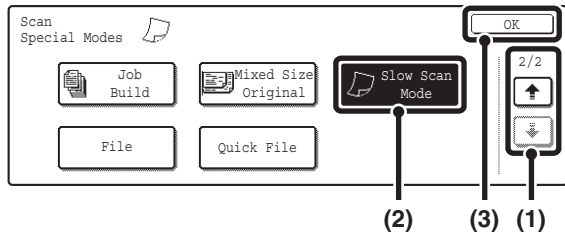

## Select slow scan mode.

- (1) Touch the keys to switch through the screens.  
If you selected Internet fax mode, go to the 3rd screen.
- (2) Touch the [Slow Scan Mode] key so that it is highlighted.
- (3) Touch the [OK] key.

5

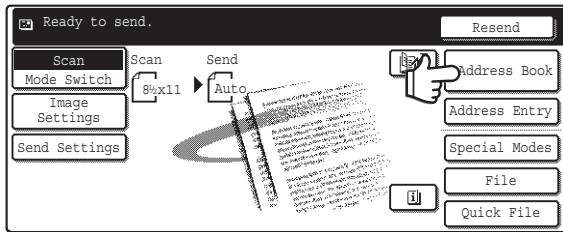

## Touch the [Address Book] key.

To directly enter a destination address, touch the [Address Entry] key.

- [ENTER THE ADDRESS MANUALLY](#) (page 23)



- When scanning to USB memory, there is no need to specify the destination. Go to step 7.
- You can touch the key to display a list of the selected special mode settings or two-sided scanning. To return to the previous screen after checking the settings, touch the [OK] key.

6

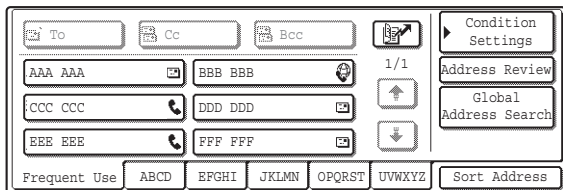

## Specify the destination.

- Touch the one-touch key for the desired destination and then the [To] key.  
 [SPECIFYING DESTINATIONS IN THE ADDRESS BOOK](#) (page 19)
- To specify a destination address in a global address book, touch the [Global Address Search] key and specify the address.  
 [CALLING UP A DESTINATION FROM A GLOBAL ADDRESS BOOK](#) (page 24)

7

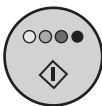

or



## Press the [COLOR START] key (○●●●) or the [BLACK & WHITE START] key (○●).

Scanning begins. A beep will sound to indicate that scanning is finished.



- If the destination is an Internet fax destination, press the [BLACK & WHITE START] key (○●).



- To cancel scanning...**  
Press the [STOP] key (⊘) to cancel the operation.



When this function is selected, automatic two-sided copying is not possible.



**To cancel the slow scan mode...**  
Touch the [Slow Scan Mode] key in the screen of step 4 so that it is not highlighted.



**System Settings (Administrator): Original Feeding Mode**  
This is used to have scanning always take place at slow scan mode.

# STORING SCAN OPERATIONS (Programs)

A destination, original settings, and functions can be stored in a program. When you wish to use those settings for a scan transmission, they can be called up with ease.

For example, suppose 8-1/2" x 11" (A4) size documents are scanned into a file and sent to each branch office once a month.

- (1) The same documents are sent to each branch office
- (2) Each page of a bound document is successively transmitted
- (3) Smudges on the edges of the documents are erased before transmission

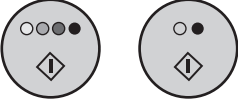
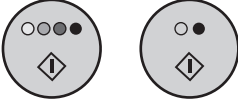
When a job program is not stored	When a job program is stored
<p>Enter the address of each branch office.</p> <p style="text-align: center;">↓</p> <p style="text-align: center;">Dual Page Scan settings</p> <p style="text-align: center;">↓</p> <p style="text-align: center;">Erase settings</p> <p style="text-align: center;">↓</p> <div style="text-align: center;">  </div> <p style="text-align: center;">Press the [START] key. The originals are scanned and transmitted.</p>	<p>Touch a stored program key.</p> <p style="text-align: center;">↓</p> <div style="text-align: center;">  </div> <p style="text-align: center;">Press the [START] key. The originals are scanned and transmitted.</p>
<p>Considerable time is required to send the documents each month because the above settings must be selected. In addition, mistakes may occasionally be made when selecting the settings, so incorrect transmissions may occur.</p>	<p>When a program is used, settings are selected with ease by simply pressing the stored key. In addition, transmission takes place based on the stored settings so there are no chances for mistakes.</p>



- **Programs are stored, edited, and deleted using "Address Control" in the system settings. See "Storing a program" in the System Settings Guide.**
- Programs can also be stored in the Web pages. Click [Job Programs] and then [Program Registration] in the Web page menu.
- The settings stored in a program will be retained even after the program is used for transmission. The same settings can be used repeatedly for transmission.
- The following settings can be stored in programs.
  - Image send mode: Scan, Internet fax
  - Destinations
  - Original settings: Exposure, resolution
  - Special modes: Erase, Dual Page Scan, Suppress Background, 2in1
- Up to 48 programs can be stored.
- Up to 500 destinations can be stored in one program.
- This function cannot be used in USB memory mode.

1

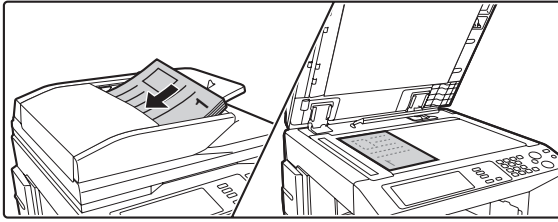

## Place the original.

Place the original in the document feeder tray or on the document glass as appropriate for the functions stored in the program.

2

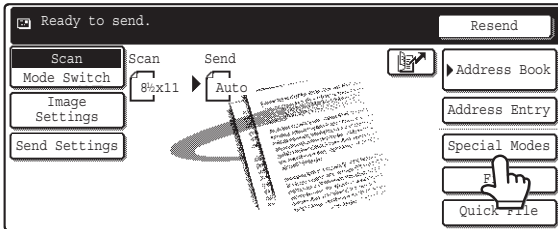

## Touch the [Special Modes] key.

3

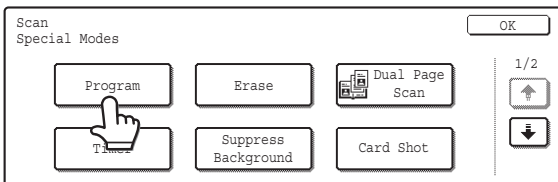

## Touch the [Program] key.

4

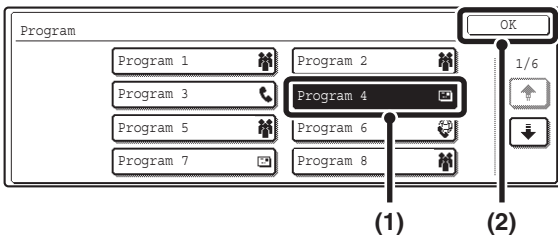

## Call up the stored program.

- (1) Touch the desired program key.
- (2) Touch the [OK] key.

5

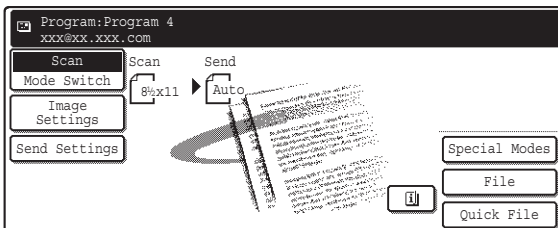

## Select additional settings.

Select any settings or functions that cannot be stored in a program. The following items can be selected.

- Image Settings : Original Scan Size, Send Size, Two-Sided Scanning, Format, Color Mode
- Send settings
- Special modes : Timer Transmission, Card Shot, Job Build, Slow Scan Mode, File, Quick File, Transaction Report



- You can touch the  key to display a list of the selected special mode settings or two-sided scanning. To return to the previous screen after checking the settings, touch the [OK] key.
- The screen that appears will vary depending on the destination stored in the program.
- The mode cannot be changed here.
- Functions stored in the program cannot be canceled here.

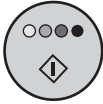

or



**Press the [COLOR START] key (○●●●) or the [BLACK & WHITE START] key (○●).**

Scanning begins.

- If you inserted the original pages in the document feeder tray, all pages are scanned.  
A beep will sound to indicate that scanning is finished.
- If you are scanning the original on the document glass, scan each page one page at a time.  
When scanning finishes, place the next original and press the [COLOR START] key (○●●●) or the [BLACK & WHITE START] key (○●). Repeat until all pages have been scanned and then press the [Read-End] key.  
A beep will sound to indicate that scanning is finished.

---

---

# FORWARDING A RECEIVED INTERNET FAX TO AN E-MAIL ADDRESS (Inbound Routing Settings)

Received Internet faxes can be automatically forwarded to a specified E-mail address. This function can be used to forward received Internet faxes directly to an e-mail address without printing the Internet faxes.

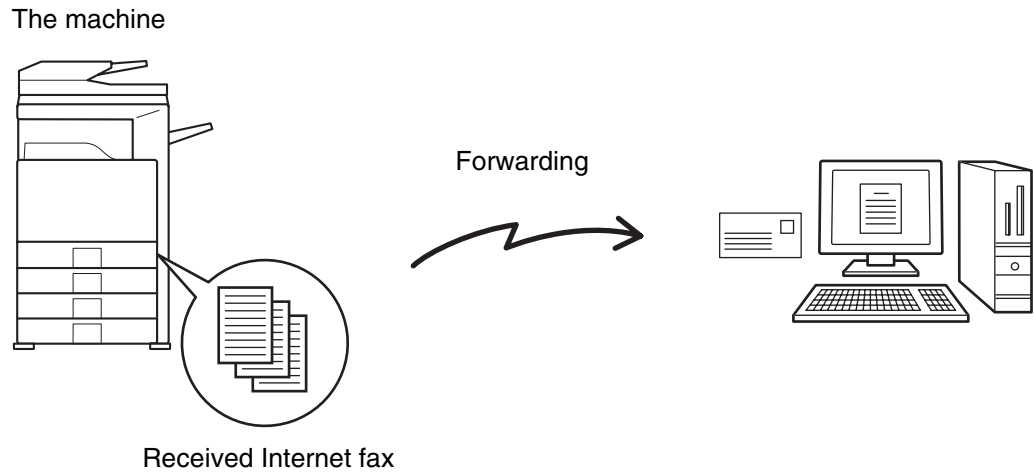

To configure inbound routing settings, click [Application Settings] and then [Inbound Routing Settings] in the Web page menu. (Administrator rights are required.)

 The format, exposure, and resolution settings of the received Internet fax remain in effect when the Internet fax is forwarded.

# 8

# INTERNET FAX FUNCTIONS

This chapter explains Internet fax communication functions, including the basic procedure for receiving Internet faxes and the procedure for selecting conditions for printing a transaction report.

## RECEIVING AN INTERNET FAX

The Internet fax function periodically\* connects to the mail server (POP3 server) and checks whether or not Internet faxes have been received. If so, the faxes are automatically retrieved and printed.

\*The default setting is once in five minutes.



If faxes will be received at night, keep the main power switch in the "on" position.

1

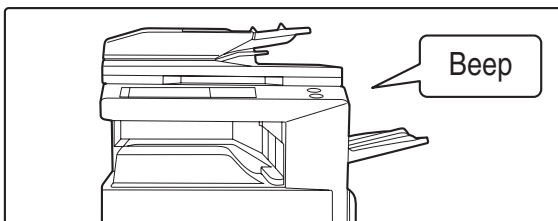

### Internet faxes are received automatically.

When reception ends, a beep sounds and printing begins.

2

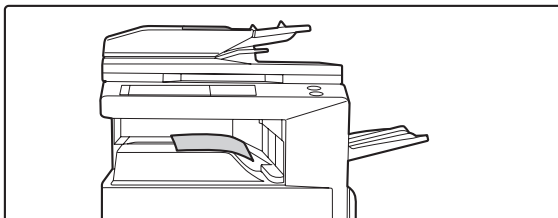

### The faxes are printed.



If the machine is out of paper or there is no paper that matches the size of the received fax, a message will appear in the touch panel. Follow the instructions in the message to load an appropriate size of paper.



#### • System Settings: Internet Fax Data Forward

When printing is not possible because the machine has run out of paper or toner, received Internet faxes can be forwarded to and printed by another previously stored Internet fax machine.

#### • System Settings (Administrator): I-Fax Default Settings

These settings determine the handling of received faxes when the [POWER] key (  ) is "off" (the main power switch is "on"), the volume of the beep that sounds when reception ends, and whether or not received e-mail messages are printed.

#### • System Settings (Administrator): I-Fax Receive Settings

Settings related to Internet fax reception can be configured such as the interval for checking for received faxes, duplex reception, output settings, auto reduction printing, and storing reject reception addresses.



# MANUALLY RECEIVING INTERNET FAXES

If the interval for checking for received faxes is somewhat long and you wish to check immediately, you can manually initiate reception.

**1**

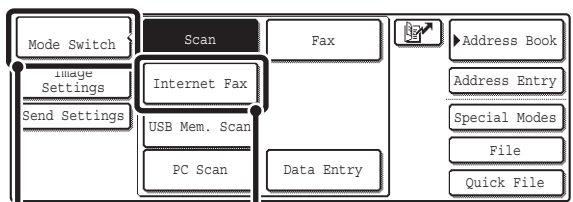

The screenshot shows a control panel with several buttons. On the left, there is a vertical stack of buttons: 'Mode Switch', 'Image Settings', and 'Send Settings'. In the center, there is a 'Scan' section containing 'Internet Fax', 'USB Mem. Scan', and 'PC Scan'. To the right of 'Scan' is a 'Fax' button. Further right, there is a 'Data Entry' button. On the far right, there is a vertical stack of buttons: 'Address Book', 'Address Entry', 'Special Modes', 'File', and 'Quick File'. A hand icon is shown touching the 'Mode Switch' button, labeled with a circled '1'. Another hand icon is shown touching the 'Internet Fax' button, labeled with a circled '2'.

**Change to Internet fax mode.**

- (1) Touch the [Mode Switch] key.
- (2) Touch the [Internet Fax] key.

**2**

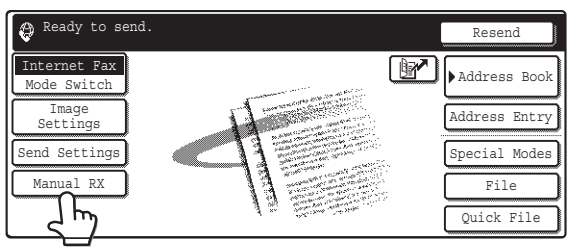

The screenshot shows a screen titled 'Ready to send.' with a 'Resend' button in the top right. On the left, there is a vertical stack of buttons: 'Internet Fax', 'Mode Switch', 'Image Settings', 'Send Settings', and 'Manual RX'. A hand icon is shown touching the 'Manual RX' button. In the center, there is a preview of a fax document. On the right, there is a vertical stack of buttons: 'Address Book', 'Address Entry', 'Special Modes', 'File', and 'Quick File'.

**Touch the [Manual RX] key.**

The machine connects to the mail server and begins reception of new faxes.

 If POP3 server settings are not configured in the Web pages, the [Manual RX] key is grayed out to prevent selection.

 **System Settings: Internet Fax Manual Reception**

This setting is used to hide the [Manual RX] key that appears in the base screen of Internet fax mode. When the [Manual RX] key is hidden, manual reception is begun by touching the [Reception Start] key in the "Internet Fax Manual Reception" screen.



---

---

# PRINTING FAXES RECEIVED TO MEMORY

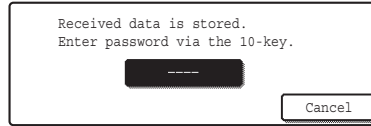
"Hold Setting for Received Data Print" in the system settings (administrator) can be enabled to have faxes received to memory without being printed. To print the faxes, a password must be entered. When this function is enabled, a password entry screen appears in the touch panel when Internet faxes are received.



When the previously programmed 4-digit password is entered with the numeric keys, printing begins. The [Cancel] key can be touched to close the password entry screen; however, the data in memory key () will blink in the touch panel. The password entry screen will reappear when you touch the blinking key () or change modes.

-  • The received faxes will be retained in memory regardless of whether they were received automatically or manually. If a transaction report is set to print when a fax is received, the transaction report will also be retained in memory.
- If "Internet Fax Data Forward" is enabled in the system settings so that received faxes are forwarded to another machine, the data retained in memory is also forwarded. At that time, the same password entry screen will appear as for printing. Forwarding will not take place unless the password is entered.

 **System Settings (Administrator): Hold Setting for Received Data Print**  
Enable this setting to have faxes received to memory without being printed. This setting is also used to program the password that must be entered to print the faxes.

# SENDING TWO PAGES AS A SINGLE PAGE (2in1)

Two original pages can be reduced to half their original size and sent together as a single page.

Portrait-oriented originals

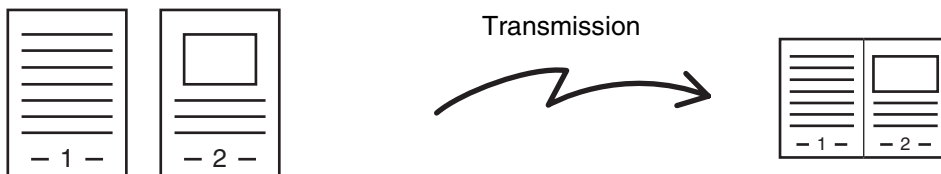

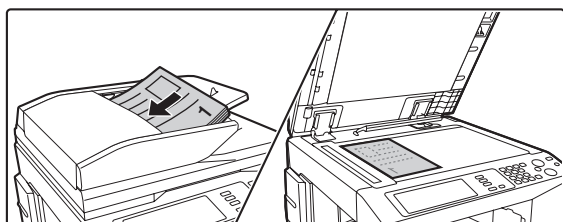

Landscape-oriented originals



**Place the original(s).**

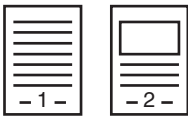
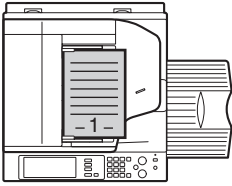
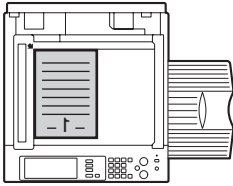

- The 2in1 function cannot be used when the originals are larger than 8-1/2" x 11" (A4) size.
- When placing the originals, orient them as explained below.

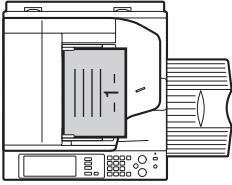
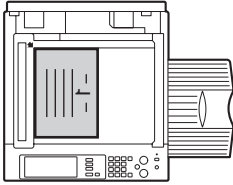
Originals	Document feeder tray Place the original face up.	Document glass Place the originals face down.
Portrait orientation 		
Landscape orientation 		

1

2

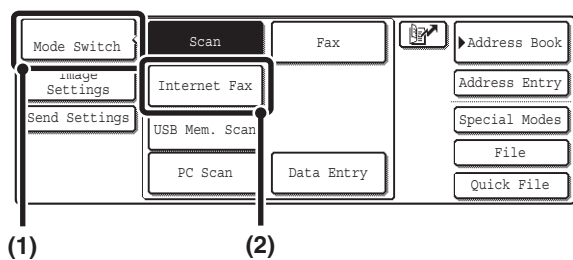

### Change to Internet fax mode.

- (1) Touch the [Mode Switch] key.
- (2) Touch the [Internet Fax] key.

3

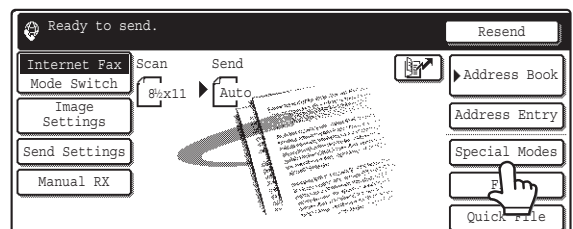

### Touch the [Special Modes] key.

4

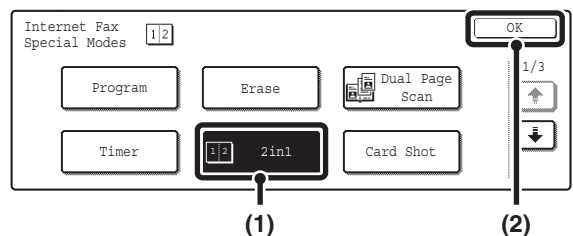

### Select 2in1.

- (1) Touch the [2in1] key so that it is highlighted.
- (2) Touch the [OK] key.

5

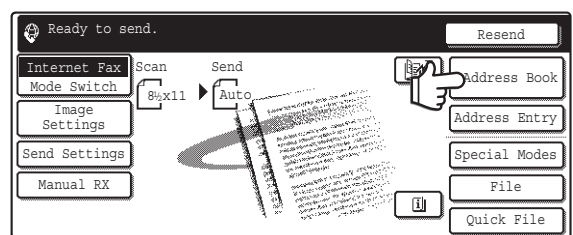

### Touch the [Address Book] key.

To directly enter a destination address, touch the [Address Entry] key.

[ENTER THE ADDRESS MANUALLY](#) (page 23)



You can touch the key to display a list of the selected special mode settings or two-sided scanning. To return to the previous screen after checking the settings, touch the [OK] key.

6

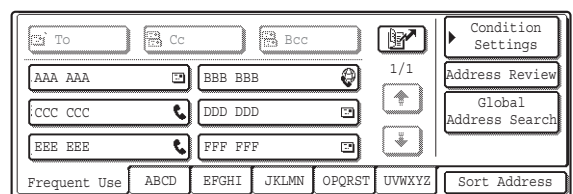

### Specify the destination.

- Touch the one-touch key of the desired destination and then the [To] key.
  - [SPECIFYING DESTINATIONS IN THE ADDRESS BOOK](#) (page 19)
- To specify a destination address in a global address book, touch the [Global Address Search] key and specify the address.
  - [CALLING UP A DESTINATION FROM A GLOBAL ADDRESS BOOK](#) (page 24)



## Press the [BLACK & WHITE START] key (○●).

Scanning begins.

- If you inserted the original pages in the document feeder tray, all pages are scanned. A beep will sound to indicate that scanning is finished.
- If you are scanning the original on the document glass, scan each page one page at a time.

When scanning finishes, place the next original and press the [BLACK & WHITE START] key (○●). Repeat until all pages have been scanned and then press the [Read-End] key.

A beep will sound to indicate that scanning is finished.



### To cancel scanning...

Press the [STOP] key (Ⓢ) to cancel the operation.



Transmission is not possible at a size smaller than the original size.



### To cancel the 2in1...

Touch the [2in1] key in the screen of step 4 so that it is not highlighted.

# CHANGING THE PRINT SETTINGS FOR THE TRANSACTION REPORT (Transaction Report)

A transaction report is automatically printed out to alert you when an Internet fax transmission fails or when a broadcast transmission is performed. The transaction report contains a description of the transmission (date, start time, name of other party, time required, number of pages, result, etc.).

Transaction reports are printed based on conditions set in the system settings; however, you can temporarily select different conditions for a transmission. To change the transaction report print conditions at the time of transmission, follow the steps below.

1

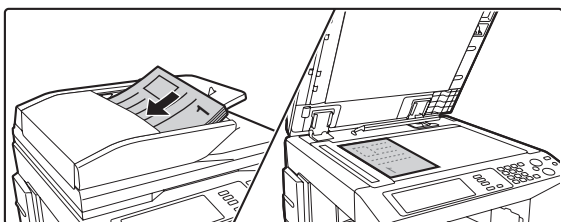

## Place the original.

Place the original face up in the document feeder tray, or face down on the document glass.

2

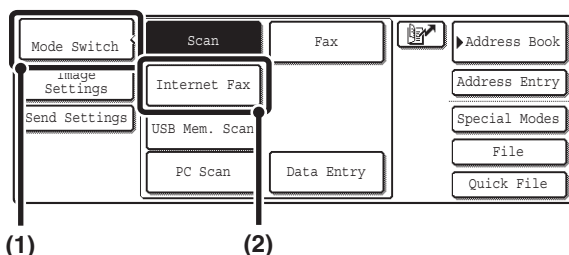

## Change to Internet fax mode.

- (1) Touch the [Mode Switch] key.
- (2) Touch the [Internet Fax] key.

3

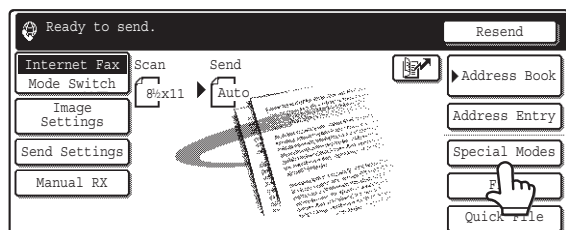

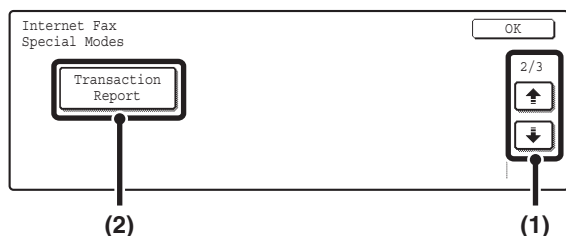

## Touch the [Special Modes] key.

4



## Select Transaction Report.

- (1) Touch the   keys to switch through the screens.
- (2) Touch the [Transaction Report] key.

5

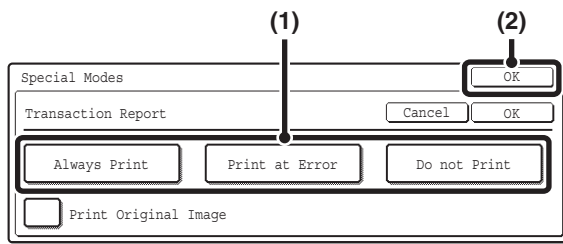

## Select print conditions.

(1) Select the print conditions.

(2) Touch the [OK] key.



- When the [Print Original Image] checkbox is selected , part of the transmitted original is included on the transaction report.
- Touch the [OK] key next to the [Cancel] key to complete the setting and return to the screen of step 4.

6

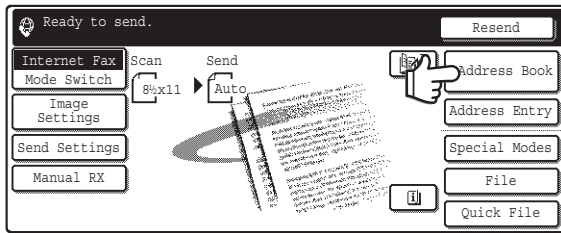

## Touch the [Address Book] key.

To directly enter a destination address, touch the [Address Entry] key.

[ENTER THE ADDRESS MANUALLY](#) (page 23)



You can touch the key to display a list of the selected special mode settings or two-sided scanning. To return to the previous screen after checking the settings, touch the [OK] key.

7

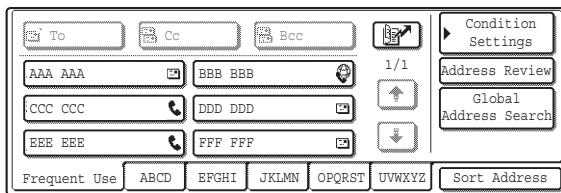

## Specify the destination.

- Touch the one-touch key of the desired destination and then the [To] key.

[SPECIFYING DESTINATIONS IN THE ADDRESS BOOK](#) (page 19)

- To specify a destination address in a global address book, touch the [Global Address Search] key and specify the address.

[CALLING UP A DESTINATION FROM A GLOBAL ADDRESS BOOK](#) (page 24)



## Press the [BLACK & WHITE START] key (○●).

Scanning begins.

- If you inserted the original pages in the document feeder tray, all pages are scanned.  
A beep will sound to indicate that scanning is finished.
- If you are scanning the original on the document glass, scan each page one page at a time.

When scanning finishes, place the next original and press the [BLACK & WHITE START] key (○●). Repeat until all pages have been scanned and then press the [Read-End] key.

A beep will sound to indicate that scanning is finished.



### To cancel scanning...

Press the [STOP] key (⏏) to cancel the operation.



For a broadcast transmission, changes to the transaction report print conditions apply to all destinations.



#### • System Settings (Administrator): Transaction Report Print Select Setting

This is used to set the conditions for printing transaction reports.

The factory default settings for printing are indicated by  below.

Single Sending: Print Out All Report//No Printed Report

Broadcasting: /Print Out Error Report Only/No Printed Report

Receiving: Print Out All Report/Print Out Error Report Only/

#### • System Settings (Administrator): Original Print on Transaction Report

This is used to have part of the transmitted original printed on the transaction report.





# CHECKING THE ACTIVITY LOG (Image Sending Activity Report)

You can have the machine print a log of recent image sending activity (date, name of other party, time required, result, etc.). The Image Sending Activity Report contains useful information such as the types of errors that occurred.

The most recent 199 transactions are included in the report.

You can have the machine print the Image Sending Activity Report each time the number of transactions reaches 200, or at a specified time (once a day only).

 The contents of the Image Sending Activity Report are erased when the report is printed, and thus it cannot be reprinted.

 **System Settings (Administrator): Activity Report Print Select Setting**  
This is used to set the conditions for printing activity reports. The factory default setting is not to print. The Image Sending Activity Report can be set to print each time the number of transactions reaches 200, or at a specified time (once a day only).

## INFORMATION APPEARING IN THE RESULT COLUMN

Error types and other information are printed in the result column of transaction and activity reports. When a transaction report or activity report is printed, check the result of the transaction in the result column and take action as needed.

### Examples of messages that are printed in the result column

Message	Explanation
OK	The transaction was completed normally.
OK REPORT	A receive report was requested for a transmission, the transmission was completed normally, and the receive report was received from the destination.
CANCEL	A transmission was stopped while in progress, or a reserved transmission job was canceled.
MEM. FULL	The memory became full during reception.
REJECTED	An Internet fax was sent from a party that is blocked.
NG REPORT	A receive report was requested for a transmission, however, the transmission did not take place correctly and a transmission failed report was received.
NO REPORT	A receive report was requested for a transmission, however, a report was not received within the timeout time.
NG LIMIT	Transmission was not possible because the file size exceeded the machine's file size limit setting.
RECEIVED	An e-mail was received, however, the attached file was not a TIFF-F file or there was no attached file, and thus printing was not possible.
FAIL xx (xxxx)	The transaction failed due to a communication error. First two digits of communication error number: Error code from 00 to 99. Last four digits of communication error number: Code for use by service technicians.

---

---

# SENDING AN INTERNET FAX FROM A COMPUTER (PC-I-Fax)

A file on a computer can be sent via the machine as an Internet fax (PC-I-Fax function). Internet faxes are sent using the PC-I-Fax function in the same way as documents are printed. Select the PC-Fax driver as the printer driver for your computer and then select the Print command in the software application. Image data for transmission will be created and sent as an Internet fax.

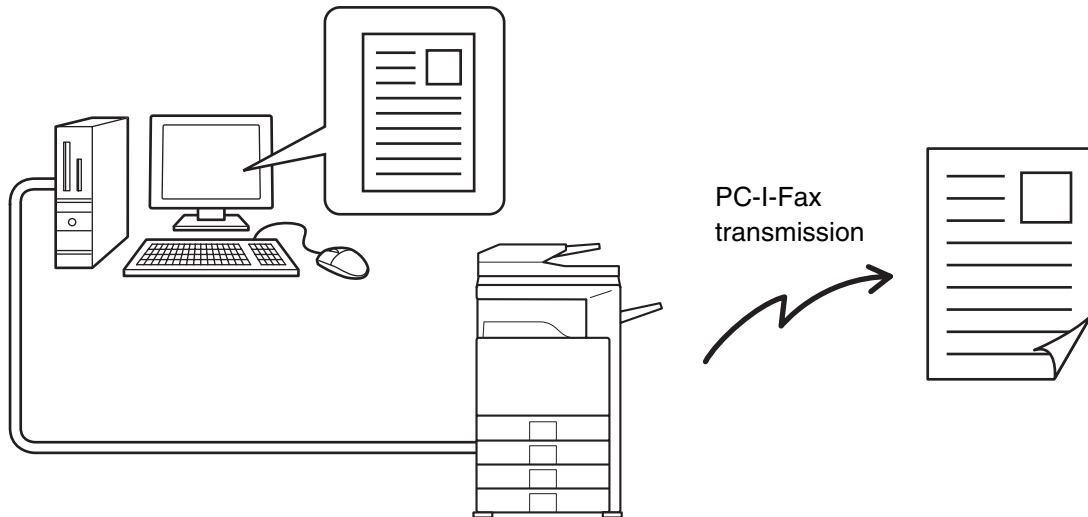

For information, see the PC-Fax driver Help.

- To send an Internet fax using the PC-I-Fax function, the PC-Fax driver must be installed and then updated using the CD-ROM that accompanies the Internet fax expansion kit. For more information, see the Software Setup Guide.
- This function can only be used when your computer is a Windows computer.
- This function can only be used for transmission. Internet faxes received on the machine cannot be received to a computer that is connected to the machine.

# 9

## SCANNING FROM A COMPUTER (PC SCAN MODE)

### BASIC SCANNING PROCEDURE

You can install the scanner driver on your computer from the CD-ROM that accompanies the machine, and use a TWAIN\* compliant application to execute scanning from your computer.

Scanning from your computer is most useful for scanning a single original such as a photo, particularly when you want to adjust scan settings as you scan. By contrast, scanning at the machine is most useful for continuous scanning of multiple originals.

\* An interface standard used for scanners and other image input devices. When the scanner driver is installed on your computer, you can use any TWAIN-compliant application to scan an image.

- Scanning in PC scan mode is only possible when the scanner driver has been installed from the "Software CD-ROM" using the integrated installer. For the procedures for installing the scanner driver and configuring settings, see the Software Setup Guide.
- This function cannot be used when it has been disabled using "Disable Scan Function" in the system settings (administrator).
- The procedures for selecting the scanner driver and starting scanning vary depending on the TWAIN-compliant application. For more information, see the manual for the application or Help.
- When a large image is scanned at high resolution, the amount of data will be very large and scanning will take a long time. Be sure to select appropriate scan settings for the original (text, photo, etc.).

As an example, the procedure for scanning from the "Sharpdesk" application in the network scanner expansion kit that accompanies the machine is explained below.

#### [At the machine]

1

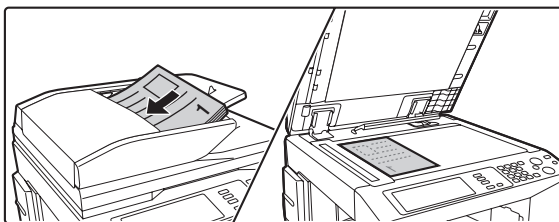

#### Place the original.

Place the original face up in the document feeder tray, or face down on the document glass.

2

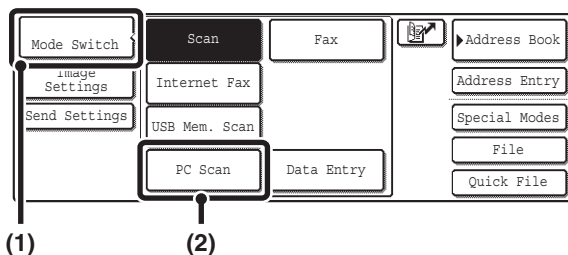

#### Change to PC Scan mode.

(1) Touch the [Mode Switch] key.

(2) Touch the [PC Scan] key.



When PC scan mode is selected, only the [Exit] key displayed in the touch panel can be used on the machine; no other keys can be used.

## [At your computer]

3

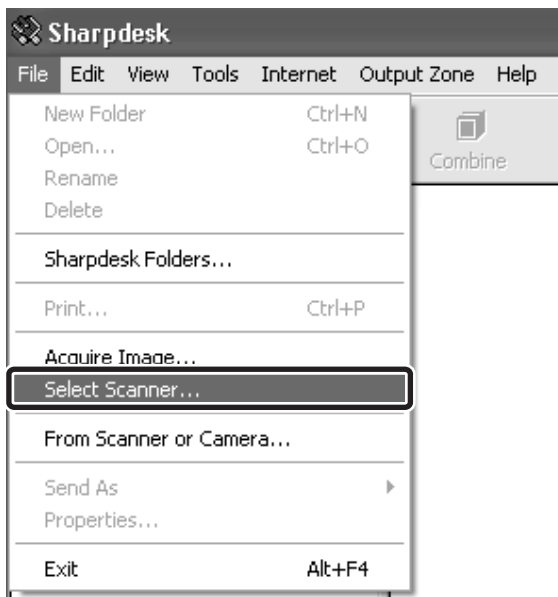

Start the TWAIN-compliant application on your computer and select [Select Scanner] from the [File] menu.

4

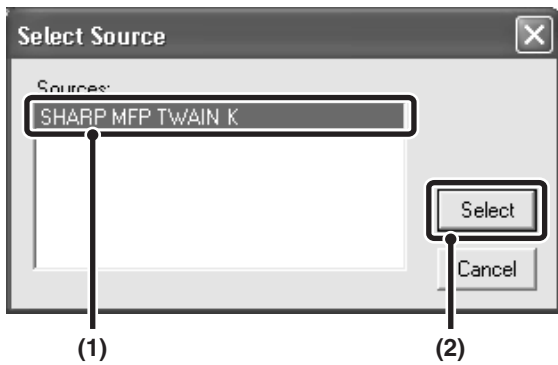

Select the scanner driver of the machine.

- (1) Select [SHARP MFP TWAIN K].
- (2) Click the [Select] button.

5

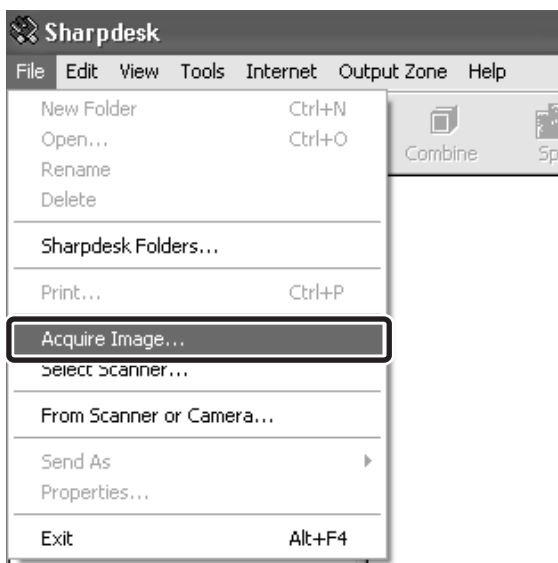

Select [Acquire Image] from the [File] menu.

The scanner driver opens.

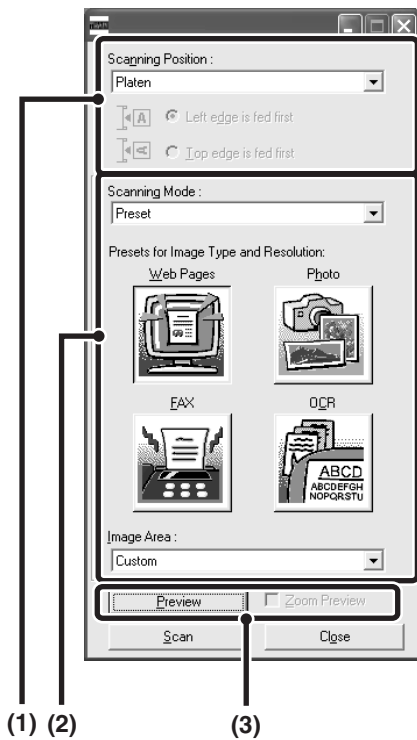

## Preview the image.

### (1) Select the location where the original is placed.

#### "Scanning Position" menu:

- If the original is a one-sided original and is placed in the document feeder tray, select [SPF(Simplex)].
- If the original is a two-sided original and is placed in the document feeder tray, select [SPF(Duplex - Book)] or [SPF(Duplex - Tablet)] depending on whether the original is a book-style or tablet-style original. In addition, select [Left edge is fed first] or [Top edge is fed first] depending on the orientation of the original.

### (2) Select scan settings.

#### "Scanning Mode" menu:

Switch between the "Preset" screen and the "Custom Settings". In the "Preset" screen, select "Web Pages", "Photo", "FAX" or "OCR" depending on the original type and your scanning purpose.

If you wish to change the initial settings of any of the four buttons or select the resolution or other advanced settings, change to the "Custom Settings" screen.

#### "Image Area" menu:

Select the scan area. If "Auto" is selected, the original size detected by the machine will be scanned. You can also set the scanning area in the preview window with your mouse.

### (3) Click the [Preview] button.

The preview image will appear in the scanner driver.

If you are not satisfied with the preview image, repeat (2) and (3).

If the [Zoom Preview] checkbox is selected before the [Preview] button is clicked, the selected area will be enlarged in the preview window. If the checkmark is removed, the preview image will return to normal. Note that if SPF is selected in the "Scanning Position" menu, the [Zoom Preview] function cannot be used.



- For further information on the scan settings, click the  button in the preview image screen in step 7 to open scanner driver Help.
- If the [Preview] button is clicked when scanning from the document feeder tray, only one original page will be scanned for the preview image. If you wish to include that original in the scan, return it to the document feeder tray.



## Select scanning settings while viewing the image.

### [Rotate] button:

Each time this button is clicked, the preview image rotates 90 degrees. This lets you change the orientation of the image without picking up and placing the original again. The image file will be created using the orientation that appears in the preview window.

### [Image Size] button:

Click this button to specify the scan area by entering numerical values. Pixels, mm, or inches can be selected for the units of the numerical values. If a scanning area has already been specified, the entered numbers will change the area relative to the top left corner of the specified area.

### button:

To automatically set the scanning area to the entire preview image, click the  button with the preview image displayed and a scanning area not specified.



- For further information on the scan settings, click the  button to open scanner driver Help.
- If the originals are placed in the document feeder tray, only the top page will be previewed. The top page will be delivered to the original exit tray. Be sure to return the previewed page to the document feeder tray before previewing again or scanning.

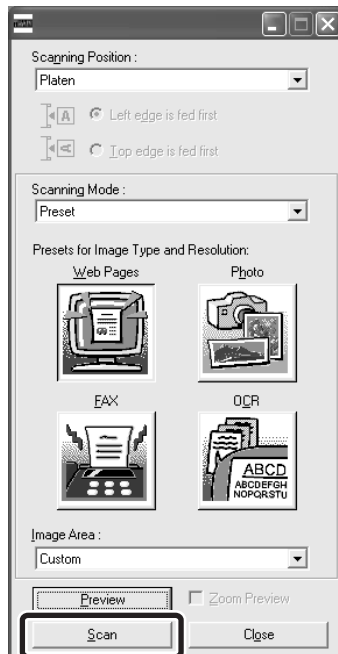

## Click the [Scan] button.

Scanning begins. The image appears in your application. Use your application to select a name for the image file and save it.

## [At the machine]

9

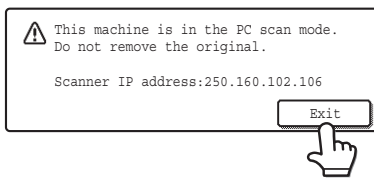

Touch the [Exit] key in the touch panel.

10

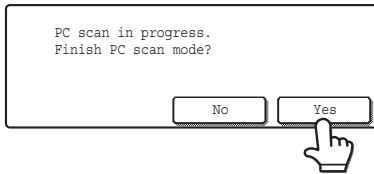

Touch the [Yes] key.

**SHARP**<sup>®</sup>

MODEL: MX-FXX1

# Facsimile Guide





---

---

# TABLE OF CONTENTS

<b>ABOUT THIS MANUAL</b> .....	4
• MANUALS PROVIDED WITH THE MACHINE . . .	4

## 1 BEFORE USING FAX MODE

<b>BASE SCREEN OF FAX MODE</b> .....	6
• BASE SCREEN OF FAX MODE .....	7
• ADDRESS BOOK SCREEN .....	10
<b>FAX TRANSMISSION SEQUENCE</b> .....	11

## 2 BASIC TRANSMISSION METHODS

<b>TRANSMISSION METHODS</b> .....	13
• PLACEMENT ORIENTATION OF THE ORIGINAL .....	15
• AUTOMATIC REDUCTION OF THE TRANSMITTED IMAGE .....	15
• TRANSMITTABLE ORIGINAL SIZES .....	16
• THE SIZE OF THE PLACED ORIGINAL .....	16
• WHEN THE LINE IS BUSY .....	17
• WHEN A COMMUNICATION ERROR OCCURS .....	17
<b>USING THE AUTOMATIC DOCUMENT FEEDER FOR TRANSMISSION</b> .....	18
• USING THE AUTOMATIC DOCUMENT FEEDER TO SEND A FAX IN DIRECT TRANSMISSION MODE .....	19
<b>USING THE DOCUMENT GLASS FOR TRANSMISSION</b> .....	21
• USING THE DOCUMENT GLASS TO SEND A FAX IN DIRECT TRANSMISSION MODE .....	23
<b>TRANSMISSION BY REDIALING (RESEND)</b> .....	25
<b>TRANSMISSION USING THE SPEAKER</b> .....	26
<b>CHANGING THE RESOLUTION AND EXPOSURE</b> .....	28
• CHANGING THE RESOLUTION .....	28
• CHANGING THE EXPOSURE .....	29
<b>SPECIFYING THE ORIGINAL SCAN SIZE AND SEND SIZE (Enlarge/Reduce Sending)</b> .....	30
• SPECIFYING THE SCAN SIZE OF THE ORIGINAL .....	31
• SPECIFYING THE SEND SIZE .....	33
<b>AUTOMATICALLY SCANNING BOTH SIDES OF AN ORIGINAL (2-sided original)</b> .....	34

## 3 ENTERING DESTINATION FAX NUMBERS

<b>ENTERING A FAX NUMBER WITH THE NUMERIC KEYS</b> .....	35
<b>CALLING UP A FAX NUMBER FROM THE ADDRESS BOOK</b> .....	36
• CALLING UP A STORED DESTINATION .....	37
• CHECKING AND DELETING ENTERED DESTINATIONS .....	38
• DISPLAYING ONLY FAX OR GROUP DESTINATIONS .....	39
• CHANGING THE INDEX .....	40
<b>CALLING UP A DESTINATION FROM A GLOBAL ADDRESS BOOK</b> .....	41
<b>USING A SEARCH NUMBER TO CALL UP A DESTINATION</b> .....	43
<b>CHAIN DIALING</b> .....	44

## 4 FAX RECEPTION

<b>RECEIVING FAXES</b> .....	45
• RECEIVING A FAX .....	46
• PRINTING A PASSWORD-PROTECTED FAX (Hold Setting For Received Data Print) .....	47

## 5 CHECKING THE STATUS OF FAX JOBS

<b>JOB STATUS SCREEN</b> .....	48
• JOB QUEUE SCREEN AND COMPLETED JOB SCREEN .....	49
• OPERATION WHEN A JOB IN THE JOB QUEUE IS COMPLETED .....	52
• CHECKING A RESERVED JOB OR THE JOB IN PROGRESS .....	53
• CHECKING COMPLETED JOBS .....	54
<b>CANCELING A FAX IN PROGRESS OR A RESERVED FAX</b> .....	55
<b>GIVING PRIORITY TO A RESERVED FAX JOB</b> .....	56

## 6 PRINTING A TRANSACTION REPORT / IMAGE SENDING ACTIVITY REPORT

<b>TRANSACTION REPORT</b> .....	57
• CHANGING THE TRANSACTION REPORT PRINT CONDITION FOR A SINGLE TRANSMISSION .....	58
• INFORMATION APPEARING IN THE RESULT COLUMN .....	59
<b>IMAGE SENDING ACTIVITY REPORT</b> .....	60
• INFORMATION APPEARING IN THE RESULT COLUMN .....	61

## 7 CONVENIENT FUNCTIONS

<b>SENDING THE SAME FAX TO MULTIPLE DESTINATIONS (Broadcast transmission)</b> .....	62
<b>SENDING A FAX AT A SPECIFIED TIME (Timer)</b> ..	66
<b>ERASING PERIPHERAL SHADOWS ON THE IMAGE (Erase)</b> .....	69
<b>TRANSMITTING AN ORIGINAL AS TWO SEPARATE PAGES (Dual Page Scan)</b> .....	72
<b>SENDING TWO PAGES AS A SINGLE PAGE (2in1)</b> .....	75
<b>SENDING BOTH SIDES OF A CARD AS A SINGLE PAGE (Card Shot)</b> .....	78
<b>STORING FAX OPERATIONS (Programs)</b> .....	81
<b>ADDING YOUR SENDER INFORMATION TO FAXES (Own number sending)</b> .....	84
• TEMPORARILY CHANGING THE SENDER INFORMATION (Own Number Select) .....	85
<b>TRANSMITTING ORIGINALS OF DIFFERENT SIZES (Mixed Size Original)</b> .....	86
<b>FAXING THIN ORIGINALS (Slow Scan Mode)</b> .....	88
<b>SENDING A LARGE NUMBER OF PAGES (Job Build)</b> .....	90
<b>CALLING A FAX MACHINE AND INITIATING RECEPTION (Polling)</b> .....	92
• INITIATING POLLING RECEPTION MANUALLY .....	94
<b>SENDING A FAX WHEN ANOTHER MACHINE POLLS YOUR MACHINE (Polling memory)</b> .....	96
• RESTRICTING POLLING ACCESS (Polling security) .....	96
• SCANNING A DOCUMENT INTO A MEMORY BOX FOR POLLING TRANSMISSION .....	97
• PRINTING A DOCUMENT STORED IN THE PUBLIC BOX .....	99

• DELETING A DOCUMENT FROM THE PUBLIC BOX .....	100
<b>FORWARDING RECEIVED FAXES (Fax Data Forward)</b> .....	101
<b>SENDING A FAX DIRECTLY FROM A COMPUTER (PC-Fax)</b> .....	103
<b>FORWARDING A RECEIVED FAX TO AN E-MAIL ADDRESS (Inbound Routing Settings)</b> .....	104

## 8 PERFORMING F-CODE COMMUNICATION

<b>F-CODE COMMUNICATION</b> .....	105
• HOW F-CODES WORK .....	105
• CREATING MEMORY BOXES IN THE MACHINE FOR F-CODE COMMUNICATION ..	106
• F-CODE DIALING .....	107
<b>CONFIDENTIAL COMMUNICATION USING F-CODES</b> .....	108
• F-CODE CONFIDENTIAL TRANSMISSION ..	109
• PRINTING A FAX RECEIVED BY F-CODE CONFIDENTIAL RECEPTION .....	110
<b>POLLING RECEPTION USING F-CODES</b> .....	112
<b>POLLING MEMORY TRANSMISSION USING F-CODES</b> .....	114
• SCANNING A DOCUMENT INTO A MEMORY BOX FOR F-CODE POLLING TRANSMISSION .....	114
• PRINTING A DOCUMENT STORED FOR F-CODE POLLING TRANSMISSION .....	117
• DELETING A DOCUMENT STORED FOR F-CODE POLLING TRANSMISSION .....	118
<b>RELAY REQUEST TRANSMISSION USING F-CODES</b> .....	119
<b>RELAY BROADCAST TRANSMISSION USING F-CODES</b> .....	121

## 9 USING AN EXTENSION PHONE

<b>CONNECTING AND USING AN EXISTING PHONE (Extension phone connection)</b> .....	122
• RECEIVING A FAX AFTER ANSWERING A CALL ON THE EXTENSION PHONE (Remote reception) .....	123
• MAKING AND RECEIVING PHONE CALLS ..	123

## 10 IF THE MACHINE IS MOVED

<b>CONNECTIONS AND SETTINGS AFTER THE MACHINE IS MOVED</b> . . . . .	<b>124</b>
• CONNECTION TO THE TELEPHONE LINE . . .	124
• SETTING THE TELEPHONE LINE TYPE . . . . .	125
• MAKING SURE THAT THE MAIN POWER IS ON . . . . .	125
• CHANGING THE SENDER FAX NUMBER . . .	125
• CHECKING THE DATE AND TIME . . . . .	126

## 11 SYSTEM SETTINGS FOR FAX

<b>System Settings</b> . . . . .	<b>127</b>
<b>Accessing the System Settings (General)</b> . . . . .	<b>128</b>
• When User Authentication is not Enabled . . . . .	128
• When User Authentication is Enabled . . . . .	129
<b>System Settings (General) List</b> . . . . .	<b>132</b>
<b>List Print (User)</b> . . . . .	<b>134</b>
• Sending Address List . . . . .	134
<b>Address Control</b> . . . . .	<b>135</b>
• Storing a One-touch (Individual) Key for Fax . . .	135
• Storing a Group Key . . . . .	140
• Storing a Program . . . . .	144
• Modify/Delete a One-touch Key or Program. . .	146
• Programming an F-code Memory Box (Polling Memory) . . . . .	149
• Programming an F-code Memory Box (Confidential) . . . . .	151
• Programming an F-code Memory Box (Relay Broadcast) . . . . .	154
• Editing and Deleting F-code Memory Boxes . . .	157
• Changing the Name of a Custom Index . . . . .	159
<b>Fax Data Receive/Forward</b> . . . . .	<b>160</b>
• Fax Receive Settings . . . . .	160
<b>Accessing the System Settings (Administrator)</b> .	<b>161</b>
• When User Authentication is not Enabled . . . . .	161
• When User Authentication is Enabled . . . . .	163
<b>System Settings (Administrator) List</b> . . . . .	<b>165</b>
<b>Operation Settings</b> . . . . .	<b>171</b>
<b>Device Control</b> . . . . .	<b>174</b>
<b>Image Send Setting</b> . . . . .	<b>175</b>
• Operation Settings . . . . .	175
• Fax Default Settings . . . . .	178
• Fax Send Settings . . . . .	180
• Fax Receive Settings . . . . .	182

• Fax Polling Security . . . . .	185
<b>List Print (Administrator)</b> . . . . .	<b>186</b>
<b>Enable/Disable Settings</b> . . . . .	<b>187</b>

---

---

# ABOUT THIS MANUAL

## Please note

---

- For information on installing the drivers and software cited in this manual, please refer to the Software Setup Guide.
- For information on the operating system, please refer to your operating system manual or the online Help function.
- Considerable care has been taken in preparing this manual. If you have any comments or concerns about the manual, please contact one of the SHARP service centers listed in the Safety Guide.
- This product has undergone strict quality control and inspection procedures. In the unlikely event that a defect or other problem is discovered, please contact your dealer or one of the SHARP service centers listed in the Safety Guide.
- Aside from instances provided for by law, SHARP is not responsible for failures occurring during the use of the product or its options, or failures due to incorrect operation of the product and its options, or other failures, or for any damage that occurs due to use of the product.

## Warning

---

- Reproduction, adaptation or translation of the contents of the manual without prior written permission is prohibited, except as allowed under copyright laws.
- All information in this manual is subject to change without notice.

## Illustrations and the operation panel and touch panel shown in this manual

---

The peripheral devices are generally optional, however, some models include certain peripheral devices as standard equipment. The explanations in this manual assume that a right tray and stand/2 x 500 sheet paper drawer are installed. To further explain certain functions and uses, some explanations assume that additional peripheral devices are installed.

The display screens, messages, and key names shown in the manual may differ from those on the actual machine due to product improvements and modifications.

# MANUALS PROVIDED WITH THE MACHINE

Printed manuals and manuals stored in PDF format on the machine's hard drive are provided with the machine. When using the machine, read the appropriate manual for the feature you are using.

## Printed manuals

Manual name	Contents
<b>Safety Guide</b>	This manual contains instructions for using the machine safely and lists the specifications of the machine and its peripheral devices.
<b>Software Setup Guide</b>	This manual explains how to install the software and configure settings to use the machine as a printer or scanner.
<b>Quick Start Guide</b>	This manual provides easy-to-understand explanations of all the functions of the machine in a single volume. Detailed explanations of each of the functions can be found in the manuals in PDF format.
<b>Troubleshooting</b>	This manual explains how to remove paper misfeeds and provides answers to frequently asked questions regarding the operation of the machine in each mode. Refer to this manual when you have difficulty using the machine.
<b>Facsimile Quick Reference Guide</b>	This manual explains the basic procedures for using the fax function of the machine, and provides an overview of the features of the fax function, troubleshooting procedures, and specifications.





## Operation manuals in PDF format

The manuals in PDF format provide detailed explanations of the procedures for using the machine in each mode. To view the PDF manuals, download them from the hard drive in the machine. The procedure for downloading the manuals is explained in "How to download the manuals in PDF format" in the Quick Start Guide.

Manual name	Contents
<b>User's Guide</b>	This manual provides information, such as basic operation procedures, how to load paper, and machine maintenance.
<b>Copier Guide</b>	This manual provides detailed explanations of the procedures for using the copy function.
<b>Printer Guide</b>	This manual provides detailed explanations of the procedures for using the printer function.
<b>Facsimile Guide (This manual)</b>	This manual provides detailed explanations of the procedures for using the fax function and the "System Settings" that are related to fax.
<b>Scanner Guide</b>	This manual provides detailed explanations of the procedures for using the scanner function and the Internet Fax function.
<b>Document Filing Guide</b>	This manual provides detailed explanations of the procedures for using the document filing function. The document filing function allows you to save the document data of a copy or fax job, or the data of a print job, as a file on the machine's hard drive. The file can be called up as needed.
<b>System Settings Guide</b>	This manual explains the "System Settings", which are used to configure a variety of parameters to suit the aims and the needs of your workplace. Current settings can be displayed or printed out from the "System Settings".

## Icons used in the manuals

The icons in the manuals indicate the following types of information:

	This alerts you to a situation where there is a risk of machine damage or failure.		This indicates the name of a system setting for fax and a provides a brief explanation of the setting. <b>When "System Settings for Fax:" appears:</b> A general setting is explained. <b>When "System Settings for Fax (Administrator):" appears:</b> A setting that can only be configured by an administrator is explained.
	This provides a supplemental explanation of a function or procedure.		
	This explains how to cancel or correct an operation.		

# 1

# BEFORE USING FAX MODE

This chapter provides basic information that is necessary in order to use fax mode.

## BASE SCREEN OF FAX MODE

The fax function is used by selecting settings and operations in the base screen of fax mode. To display the base screen of fax mode, press the [IMAGE SEND] key and then touch the [Mode Switch] key to select fax mode.

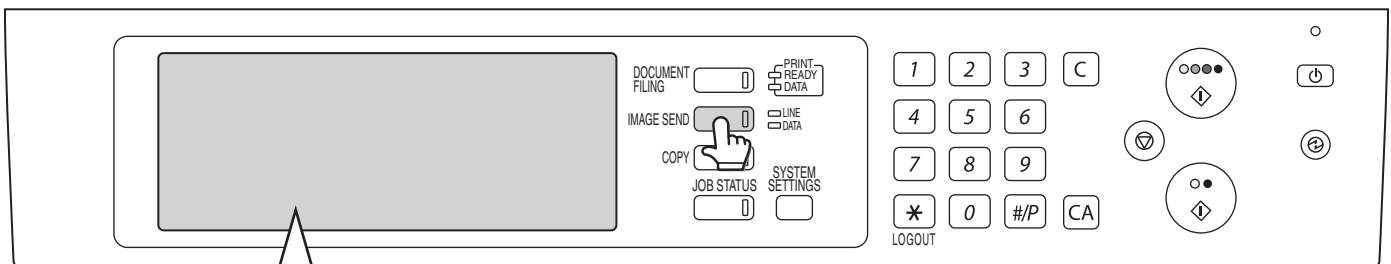

### Example: switching from scanner mode to fax mode

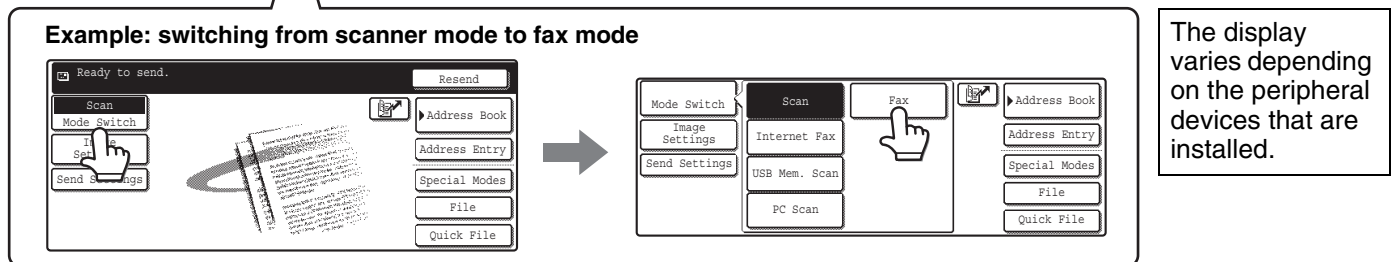

The display varies depending on the peripheral devices that are installed.

Each of the other modes that can be displayed by pressing the [IMAGE SEND] key (scan, Internet fax, USB memory scan, and PC scan modes) also have base screens.

Transmission destinations can be stored in one-touch keys in the Address Book and called up from the Address Book screen when you need to use them for transmission. The Address Book is shared by fax mode, scan mode, and Internet fax mode. To display the Address Book screen, touch the [Address Book] key in the base screen. To display the base screen, touch the [Condition Settings] key in the Address Book screen. This manual refers to the base screen of fax mode as "the base screen".

### Base screen of fax mode

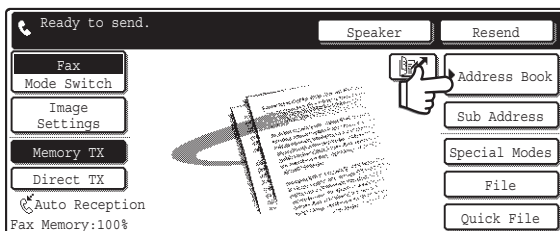

### Address Book screen

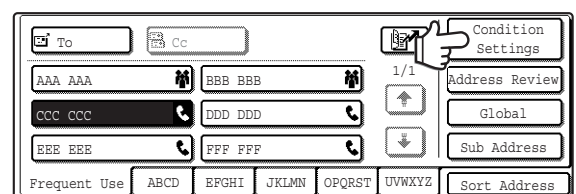

The procedures in this manual begin from the base screen of fax mode.

- System Settings for Fax (Administrator): Default Display Setting (page 175)**  
One of the following screens can be selected for the initial screen that appears when the [IMAGE SEND] key is pressed.
- Base screen of scan mode, Internet fax mode, or fax mode
  - Address Book screen (alphabetical/custom index)

# BASE SCREEN OF FAX MODE

This screen is used to select settings and operations in fax mode.

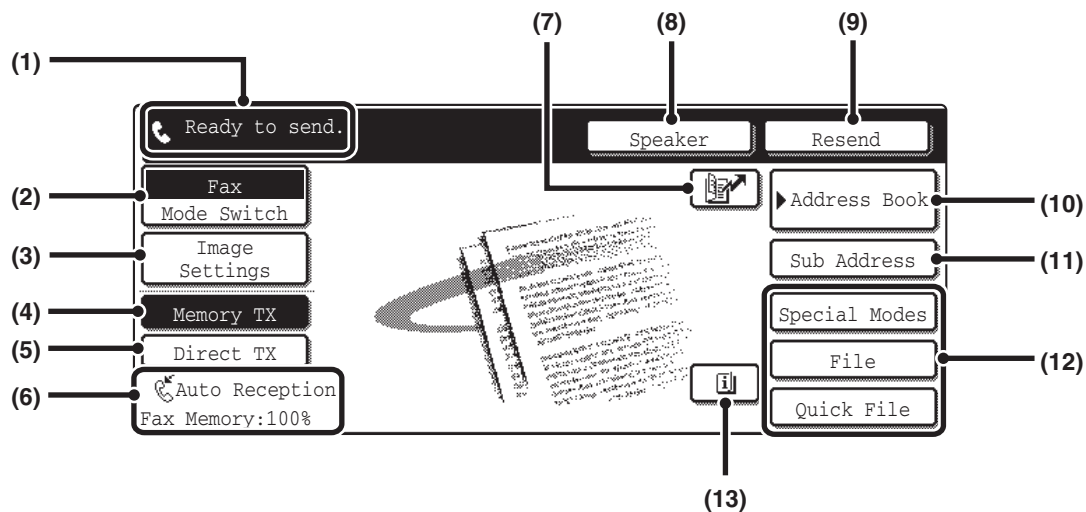

**(1) This shows various messages and the destinations that have been entered.**

The icon at the left indicates fax mode.

**(2) [Mode Switch] key**

Use these keys to change the mode of the image send function.  
[BASE SCREEN OF FAX MODE](#) (page 6)

**(3) [Image Settings] key**

Touch this key to select image settings (exposure, resolution, original size, and two-sided original) and special mode settings.  
[\[Image Settings\] key](#) (page 8)

**(4) [Memory TX] key**

This key is highlighted when a normal transmission (memory transmission mode) is performed.  
[To fax a large number of sheet originals, use the automatic document feeder.](#) (page 13)

**(5) [Direct TX] key**

Touch this key to send a fax by direct transmission.  
[If you wish to send a fax ahead of other previously reserved fax transmissions, use direct transmission mode.](#) (page 14)

**(6) This shows the currently selected fax reception mode and the amount of free memory remaining.**

[RECEIVING FAXES](#) (page 45)

**(7) key**

Touch this key to dial a fax destination using a search number.  
[USING A SEARCH NUMBER TO CALL UP A DESTINATION](#) (page 43)

**(8) [Speaker] key**

Touch this key to dial using the speaker. When entering a fax number to be dialed, the key changes to the [Pause] key. When entering a sub-address, the key changes to the [Space] key.  
[TRANSMISSION USING THE SPEAKER](#) (page 26)

**(9) [Resend] key**

Touch this key to redial a fax number. When entering a fax number to be dialed, this key changes to the [Next Address] key.  
[TRANSMISSION BY REDIALING \(RESEND\)](#) (page 25)

**(10) [Address Book] key**

Touch this key to dial using a one-touch key or group key. The Address Book screen appears when the key is touched.  
[CALLING UP A FAX NUMBER FROM THE ADDRESS BOOK](#) (page 36)

**(11) [Sub Address] key**

Touch this key to enter a sub-address and passcode for F-code transmission.  
[F-CODE DIALING](#) (page 107)

**(12) Customized keys**

These three keys can be changed to show any three settings or functions that you like. The keys are changed in "Customize Key Setting" in the system settings for Fax (administrator). Normally the following keys appear:  
[Customizing displayed keys](#) (page 8)

- **[Special Modes] key**

This is the same [Special Modes] key that appears when the [Image Settings] key is touched.

- **[File] key, [Quick File] key**

Touch either key to use the Quick File or File document filing functions. These are the same [File] and [Quick File] keys that appear when the [Special Modes] key is touched. For information on the document filing function, see the Document Filing Guide.

**(13) key**

This key appears when a convenient function (special mode) or two-sided scanning is selected. Touch the key to display the selected special modes.  
[Checking what special modes are selected](#) (page 9)

## Customizing displayed keys

Keys of convenient functions (such as special modes) can be displayed in the lower right corner of the screen. Set these keys to functions that you frequently use to access the functions with a single touch. The functions that are shown in the keys are selected with "Customize Key Setting" in the system settings for Fax (administrator).

**Example: When the Dual Page Scan, Erase, and Address Review keys are selected as the customized keys.**

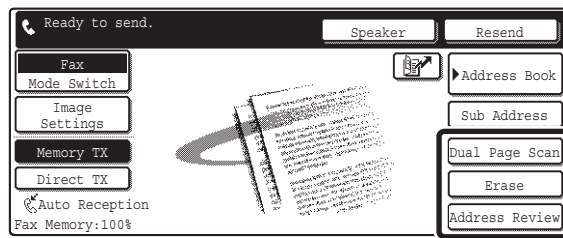

These 3 keys can be changed as desired.

- Displaying a program key in the base screen will enable you to call up the program by simply touching the key.
  - [STORING FAX OPERATIONS \(Programs\)](#) (page 81)
- To use the [Special Modes] key, [File] key, or [Quick File] key after any of these keys have been changed to a different key, touch the [Image Settings] key. The keys can be selected in the screen that appears.
  - [\[Image Settings\] key](#) (page 8)

**System Settings for Fax (Administrator): Customize Key Setting (page 172)**  
This is used to select the keys that appear in the lower right corner of the base screen.

## [Image Settings] key

When the [Image Settings] key is touched, keys for image settings appear. The [Special Modes] key also appears to allow the selection of special modes.

The currently configured setting appears at the top of the [Exposure] key, the [Resolution] key and the [Original] key.

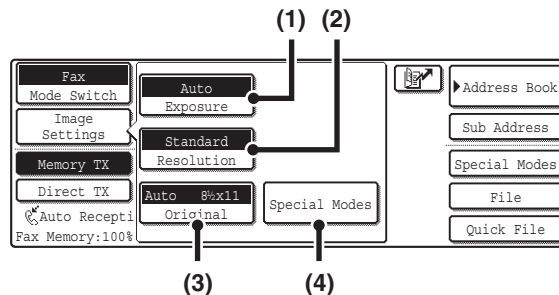

### (1) [Exposure] key

Use this key to adjust the exposure of the image.

➤ [CHANGING THE EXPOSURE](#) (page 29)

### (2) [Resolution] key

Use this key to adjust the resolution of the image.

➤ [CHANGING THE RESOLUTION](#) (page 28)

### (3) [Original] key

Touch this key to select the original size, two-sided original, and other settings.

➤ [SPECIFYING THE ORIGINAL SCAN SIZE AND SEND SIZE \(Enlarge/Reduce Sending\)](#) (page 30),

[AUTOMATICALLY SCANNING BOTH SIDES OF AN ORIGINAL \(2-sided original\)](#) (page 34)

### (4) [Special Modes] key

Touch this key to use a convenient special mode. Use this key when the [Special Modes] key that appears in the base screen has been changed to a different key using "Customizing displayed keys" (see above). To use the Quick File function or the File function, touch the [Special Modes] key to display the corresponding keys.

When the [Image Settings] key is touched in the above screen, the base screen appears.





## Checking what special modes are selected

The  key appears in the base screen when a convenient function (special mode) or two-sided scanning is selected.

The  key appears in the base screen when one or more special modes are selected.

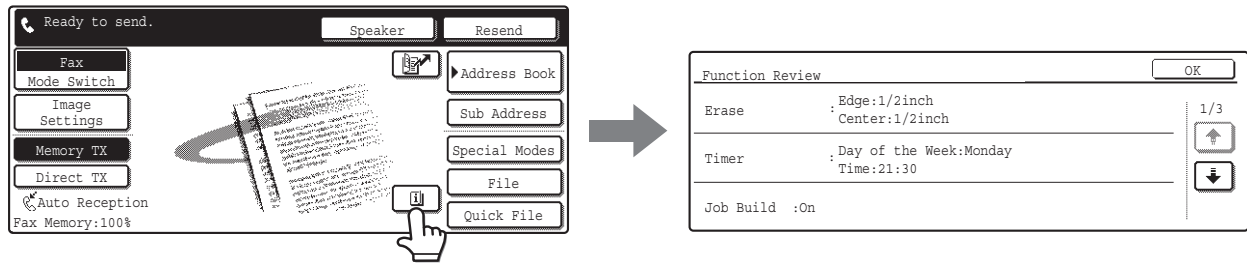
The  key can be touched to display the selected special modes. To close the screen, touch the [OK] key.



 The special mode settings cannot be changed from the function review screen. To change a setting, touch the [OK] key to close the Function Review screen and then touch the [Special Modes] key and select the setting that you wish to change.

# ADDRESS BOOK SCREEN

This screen is used to select a destination from the list of stored destinations.

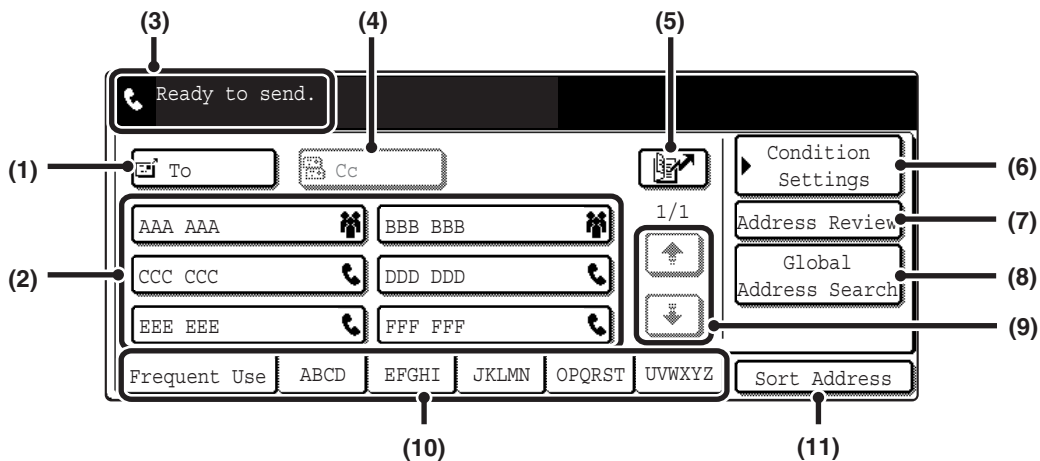

- (1) **[To] key**  
Touch this key to enter the selected destination (one-touch key).  
☞ [CALLING UP A STORED DESTINATION](#) (page 37)
- (2) **One-touch key display**  
This shows the one-touch keys of the destinations that have been stored in the Address Book. This manual refers to keys in which destinations and groups are stored as one touch keys.  
Keys that have fax numbers stored are indicated by ☎. The number of one-touch keys displayed in one screen can be changed in the system settings.  
☞ [CALLING UP A STORED DESTINATION](#) (page 37)
- (3) **This shows the destination that has been selected.**
- (4) **[Cc] key**  
Not used in fax mode.
- (5) **[Search] key**  
Touch this key to dial a fax destination using a search number.  
☞ [USING A SEARCH NUMBER TO CALL UP A DESTINATION](#) (page 43)
- (6) **[Condition Settings] key**  
Touch this key to select transmission settings and operations. When the key is touched, the base screen appears.  
☞ [BASE SCREEN OF FAX MODE](#) (page 7)
- (7) **[Address Review] key**  
Touch this key to view a list of the selected destinations.  
☞ [CHECKING AND DELETING ENTERED DESTINATIONS](#) (page 38)
- (8) **[Global Address Search] key**  
Touch this key to obtain a fax number from a global address book (LDAP server).  
☞ [CALLING UP A DESTINATION FROM A GLOBAL ADDRESS BOOK](#) (page 41)  
When the destination is selected using a one-touch key or the fax number is entered directly using the numeric keys, this key changes to the [Global] key.
- (9) **Page change keys**  
Use these keys to change pages when more one-touch keys have been stored than can be displayed on one page.
- (10) **Index tab**  
Touch this to change indexes of the one-touch key display.  
☞ [CALLING UP A STORED DESTINATION](#) (page 37)
- (11) **[Sort Address] key**  
Touch this key to change the method of displaying the Address Book screen.  
☞ [DISPLAYING ONLY FAX OR GROUP DESTINATIONS](#) (page 39), [CHANGING THE INDEX](#) (page 40)

 A different icon appears when the network scanner function or Internet fax function is used and a destination that is not for fax is stored.  
☞ [CALLING UP A FAX NUMBER FROM THE ADDRESS BOOK](#) (page 36)

-  **System Settings for Fax: Address Control**  
This is used to store fax numbers in one-touch keys.  
☞ [Storing a One-touch \(Individual\) Key for Fax](#) (page 135)
- System Settings for Fax (Administrator): The Number of Direct Address Keys Displayed Setting** (page 176)  
This is used to change the number of one-touch keys displayed in the Address Book screen.
- System Settings for Fax (Administrator): Default Display Setting** (page 175)  
This is used to change the screen that initially appears when the [IMAGE SEND] key is pressed.

# FAX TRANSMISSION SEQUENCE

This section explains the basic procedure for sending a fax.

## Place the original.

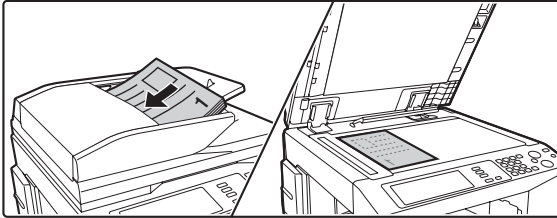

Place the original in the document feeder tray of the automatic document feeder, or on the document glass.



## Change the mode.

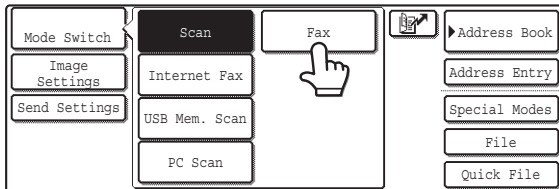

Change to fax mode.

Touch the [Mode Switch] key and then touch the [Fax] key.

☞ [BASE SCREEN OF FAX MODE](#) (page 6)



## Select image settings.

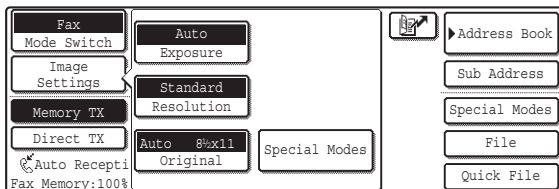

Touch the [Image Settings] key to select settings for the original to be faxed.

- [Exposure] key: Use this key to adjust the exposure of the image.  
☞ [CHANGING THE EXPOSURE](#) (page 29)
- [Resolution] key: Use this key to adjust the resolution of the image.  
☞ [CHANGING THE RESOLUTION](#) (page 28)
- [Original] key: Use this key to select the original size, the original send size and two-sided original scanning.  
☞ [SPECIFYING THE ORIGINAL SCAN SIZE AND SEND SIZE \(Enlarge/Reduce Sending\)](#) (page 30), [AUTOMATICALLY SCANNING BOTH SIDES OF AN ORIGINAL \(2-sided original\)](#) (page 34)
- [Special Modes] key: Touch this key to use a convenient special mode.



## Select convenient special modes

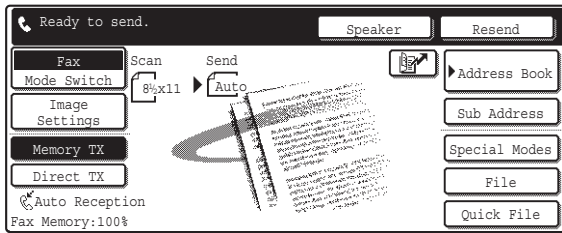

Touch the [Special Modes] key to select special modes such as timer transmission and the erase function.  
Touch the [File] key or [Quick File] key to select the document filing function.



## Enter the destination fax number

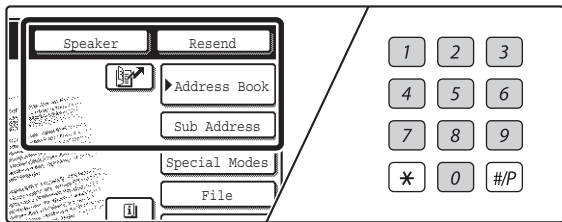

- [Address Book] key: Select a destination that is stored in the Address Book or look up a destination in a global address book.  
 ➤ [CALLING UP A STORED DESTINATION](#) (page 37)
-  key: Use a search number to specify a destination stored in the Address Book.  
 ➤ [USING A SEARCH NUMBER TO CALL UP A DESTINATION](#) (page 43)
- [Resend] key: Select a fax number from the last eight destinations used for transmission.  
 ➤ [TRANSMISSION BY REDIALING \(RESEND\)](#) (page 25)
- Numeric keys: Enter a fax number.  
 ➤ [ENTERING A FAX NUMBER WITH THE NUMERIC KEYS](#) (page 35)



## Begin transmission

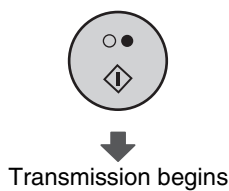

Scan the original and send the fax.

If the original is placed on the document glass, follow these steps to start scanning and transmission:

### When sending a fax normally (memory transmission)

- (1) Press the [BLACK & WHITE START] key (○●).
- (2) When scanning is finished, replace the original with the next original.
- (3) Press the [BLACK & WHITE START] key (○●).
- (4) Repeat steps (2) and (3) until all originals have been scanned.
- (5) Touch the [Read-End] key.

### When sending a fax in direct transmission mode

Multiple originals cannot be scanned in direct transmission mode. Press the [BLACK & WHITE START] key (○●) and start transmission.



When transmission ends, image settings and convenient function (special mode) settings are cleared.



**To cancel scanning...**  
Press the [STOP] key (⏹).

# 2

## BASIC TRANSMISSION METHODS

This chapter explains the basic procedures for sending a fax.

---

---

### TRANSMISSION METHODS

The methods that can be used to send a fax from the machine are explained below. Select the method that best suits your needs.

#### To fax a large number of sheet originals, use the automatic document feeder.

The originals will be scanned into memory and then transmitted (memory transmission).

When memory transmission is selected and multiple originals are placed in the automatic document feeder (and the line is free), transmission will begin as soon as the first page is scanned and will take place while the remaining pages are being scanned (Quick Online transmission).

If transmission cannot begin immediately because the line is in use, all pages will be scanned into memory and the transmission will be reserved.

🔗 [USING THE AUTOMATIC DOCUMENT FEEDER FOR TRANSMISSION](#) (page 18)

When a fax transmission or reception is already in progress, the following procedure can be performed to reserve a transmission job. To check reserved transmission jobs, display the job status screen.

🔗 [5. CHECKING THE STATUS OF FAX JOBS](#) (page 48)

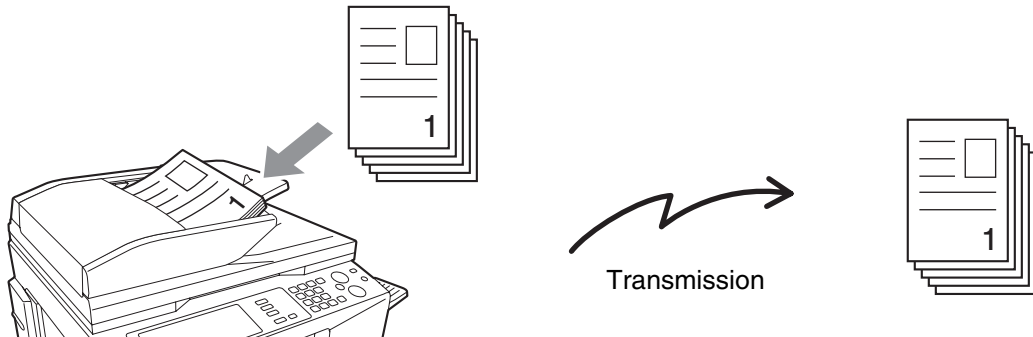

- If memory becomes full while the first original page is being scanned, transmission will stop.
- In the following situations, the transmission will be automatically reserved (memory transmission)
  - The connection cannot be made because the line of the other party is busy.
  - The machine is already using the line to send or receive a fax.
  - Another fax transmission was reserved ahead of your fax.
  - One of the following functions is being used for transmission  
Broadcast transmission, timer transmission, Dual Page Scan, 2in1, Card Shot, Job Build
  - The document glass is being used for a transmission.
- Up to 94 transmission jobs can be reserved.
- When the transmission is finished, the scanned original pages are cleared from memory. However, the transmitted fax is stored when the document filing function is used.
  - 🔗 [Document Filing Guide](#)



#### **System Settings for Fax (Administrator):** [Quick On Line Sending](#) (page 180)

This can be used to disable Quick Online transmission. In this case, fax transmissions will be sent by memory transmission (reserved and then transmitted).

## To fax thick originals or pages of a book, use the document glass.

The transmission will be reserved after all pages are scanned (memory transmission).

 [USING THE DOCUMENT GLASS FOR TRANSMISSION](#) (page 21)

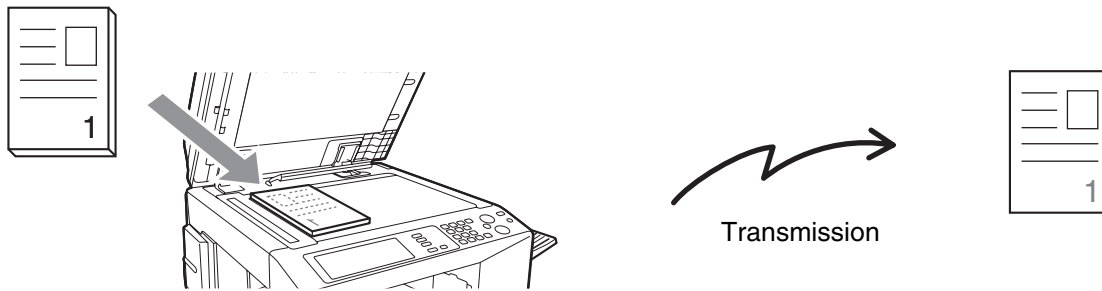

When the document glass is being used for a transmission, Quick Online transmission will not operate.

## If you wish to send a fax ahead of other previously reserved fax transmissions, use direct transmission mode.

The original is transmitted directly to the receiving fax machine without being scanned into memory.

When direct transmission mode is used, transmission will begin as soon as the transmission in progress is completed (ahead of any previously reserved transmissions).

To send a fax by direct transmission, touch the [Direct TX] key in the base screen.

 [USING THE AUTOMATIC DOCUMENT FEEDER TO SEND A FAX IN DIRECT TRANSMISSION MODE](#) (page 19),  
[USING THE DOCUMENT GLASS TO SEND A FAX IN DIRECT TRANSMISSION MODE](#) (page 23)

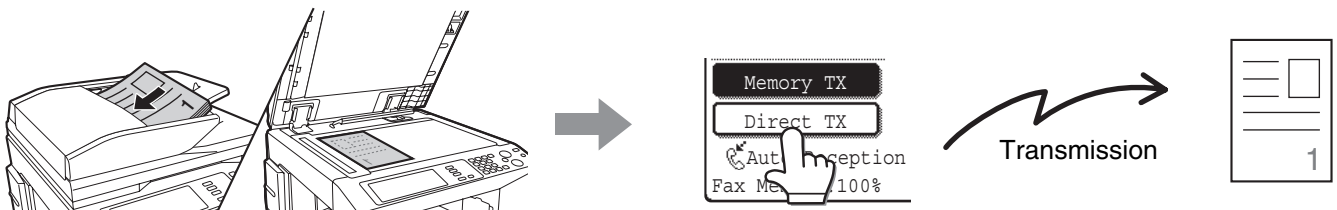

- When transmission in direct transmission mode ends, the mode automatically changes back to memory transmission mode.
- When the document glass is used, multiple original pages cannot be scanned.

# PLACEMENT ORIENTATION OF THE ORIGINAL

When an 8-1/2" x 11" (A4) original is placed in vertical orientation (⌚), the image is automatically rotated 90 degrees and transmitted in horizontal orientation (⌚) (Image rotation). If the original is placed in horizontal orientation (⌚), it is transmitted in that orientation (⌚) without being rotated.

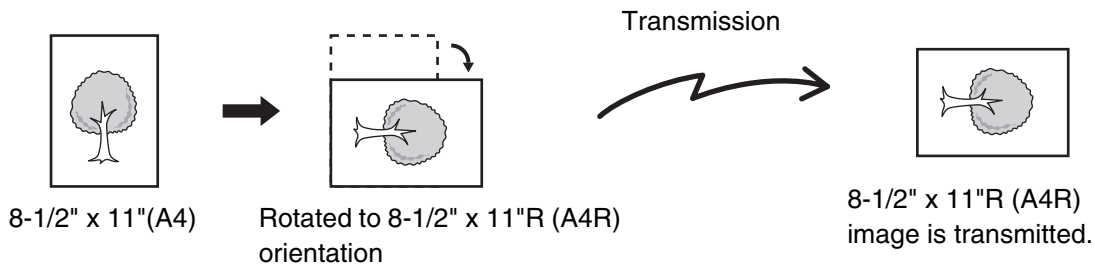

- 8-1/2" x 11"R and 5-1/2" x 8-1/2" (A4R, B5 and A5) size originals cannot be rotated for transmission.
- When placing a 11" x 17" (A3) or 8-1/2" x 14" (B4) size original, place the original in the horizontal orientation (⌚) and select for the image orientation as described in "SPECIFYING THE SCAN SIZE OF THE ORIGINAL" (page 31).
- When placing a 5-1/2" x 8-1/2" (A5) size original, orient the original as follows:  
Using the automatic document feeder: place the original(s) in the vertical orientation (⌚).  
Using the document glass: place the original in the horizontal orientation (⌚) and set the scan size manually.  
 SPECIFYING THE SCAN SIZE OF THE ORIGINAL (page 31)

**System Settings for Fax (Administrator): Rotation Sending Setting (page 180)**  
The factory default setting is rotate before transmission. If this setting is disabled, the original will be transmitted in the orientation in which it is placed.

# AUTOMATIC REDUCTION OF THE TRANSMITTED IMAGE

If the width of the transmitted image is larger than the width of the paper in the receiving machine, the image will be automatically reduced to fit the receiving machine's paper width.

## Example: Reduced sizes and reduction ratios

Transmitted image width	Receiving machine's paper width	Reduced size	Ratio
A3	B4	B4	1 : 0.84
11" x 17" (A3)	8-1/2" x 14", 8-1/2" x 11" (A4)	8-1/2" x 14", 8-1/2" x 11"R (A4R)	1 : 0.71
B4	A4	A4R	1 : 0.84

**System Settings for Fax (Administrator): Auto Reduction Sending Setting (page 180)**  
The factory default setting is automatic reduction enabled. If this setting is disabled, the image will be sent at full size and part of the image may be cut off.

# TRANSMITTABLE ORIGINAL SIZES

The following original sizes can be transmitted.

	Minimum original size	Maximum original size
Using the automatic document feeder	8-1/2" (width) x 5-1/2" (length) (A5: 210 mm (width) x 148 mm (length)) 5-1/2" (width) x 8-1/2" (length) (A5R: 148 mm (width) x 210 mm (length))	11" (width) x 31-1/2"* (length) (297 mm (width) x 800 mm* (length)) * When transmitting a long original (page 31)
Using the document glass	2-5/8" (width) x 2-5/8" (length) (64 mm (width) x 64 mm (length))	11" (width) x 17" (length) (297 mm (width) x 432 mm (length))

## THE SIZE OF THE PLACED ORIGINAL

When a standard size original is placed, the original size is automatically detected and displayed in the base screen as the "Scan" size.

When the automatic original detection function is operating and the original is a non-standard size, the closest standard size may be displayed or the original size may not appear. In this event, manually set the correct original size.

 [SPECIFYING THE SCAN SIZE OF THE ORIGINAL](#) (page 31)

## STANDARD SIZES

The standard sizes are set in "Original Size Detector Setting" in the system settings for Fax (administrator). The factory default setting is "Inch-1".

### List of original size detector settings

Selections	Detectable original sizes	
	Document glass	Document feeder tray (automatic document feeder)
AB-1	A3, A4, A4R, A5, B4, B5, B5R	A3, A4, A4R, A5, B4, B5, B5R, 8-1/2" x 11", 8-1/2" x 14", 11" x 17"
AB-2	A3, A4, A4R, A5, B5, B5R, 216 mm x 330 mm	A3, A4, A4R, A5, B4, B5, B5R, 8-1/2" x 11", 11" x 17", 216 mm x 330 mm
AB-3	A4, A4R, A5, B4, 8K, 16K, 16KR	A3, A4, A4R, A5, B4, 8K, 16K, 16KR, 8-1/2" x 11", 11" x 17", 216 mm x 330 mm
Inch-1	11" x 17", 8-1/2" x 14", 8-1/2" x 11", 8-1/2" x 11"R, 5-1/2" x 8-1/2"	11" x 17", 8-1/2" x 14", 8-1/2" x 11", 8-1/2" x 11"R, 5-1/2" x 8-1/2", A4, A3
Inch-2	11" x 17", 8-1/2" x 13", 8-1/2" x 11", 8-1/2" x 11"R, 5-1/2" x 8-1/2"	11" x 17", 8-1/2" x 13", 8-1/2" x 11", 8-1/2" x 11"R, 5-1/2" x 8-1/2", A4, A3



# WHEN THE LINE IS BUSY

If the line is busy when you send a fax, transmission will be re-attempted automatically after a preset interval. This function only operates in memory transmission mode. In direct transmission mode or manual transmission mode, the transmission will be canceled. Wait briefly and then try sending the fax again.



## To cancel transmission...

Cancel a transmission job in the job status screen.

[CANCELING A FAX IN PROGRESS OR A RESERVED FAX](#) (page 55)



## System Settings for Fax (Administrator): [Recall in Case of Line Busy](#) (page 182)

This is used to set the number of recall attempts and the interval between attempts when the connection cannot be established because the line is busy. The factory default setting is 2 attempts at an interval of 3 minutes.

# WHEN A COMMUNICATION ERROR OCCURS

If a communication error occurs or the other fax machine does not answer the call within a preset period of time, transmission will be re-attempted automatically after a preset interval. This function only operates in memory transmission mode.



## To cancel transmission...

Cancel a transmission job in the job status screen.

[CANCELING A FAX IN PROGRESS OR A RESERVED FAX](#) (page 55)



## System Settings for Fax (Administrator): [Recall in Case of Communication Error](#) (page 182)

This is used to set the number of recall attempts and the interval between attempts when a transmission fails due to an error. The factory default setting is attempt at an interval of 3 minutes.

# USING THE AUTOMATIC DOCUMENT FEEDER FOR TRANSMISSION

This section explains how to use the automatic document feeder to send a fax.

1

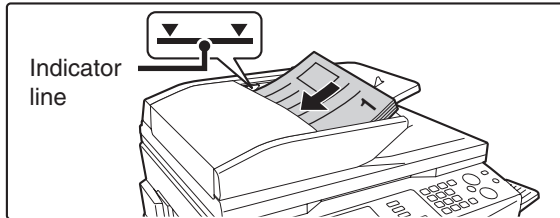

**Place the originals face up in the document feeder tray with the edges aligned evenly.**

Place the originals face up. Insert the originals all the way into the document feeder tray. The stack height must not be higher than the indicator line (maximum of 100 pages).



When sending a multi-page fax, the automatic document feeder and the document glass cannot both be used to scan the original pages.

2

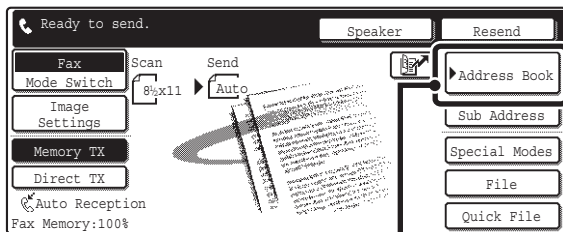

(1)

**Enter the destination fax number.**

(1) Touch the [Address Book] key.

(2) Touch the one-touch key of the desired destination.

(3) Touch the [To] key.

**CALLING UP A FAX NUMBER FROM THE ADDRESS BOOK** (page 36)

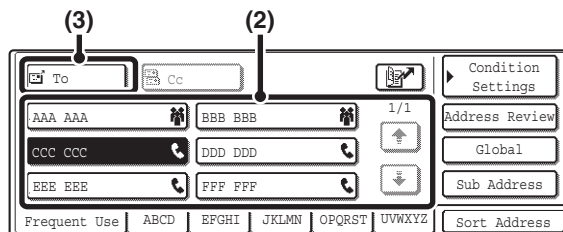

(3)

(2)

If the fax number of the transmitting machine is not stored in a one-touch key in the Address Book, enter the fax number with the numeric keys.

**ENTERING A FAX NUMBER WITH THE NUMERIC KEYS** (page 35)

3



**Press the [BLACK & WHITE START] key (○●).**

Scanning begins.

When scanning is completed, the machine sounds a beep.



When scanning is completed, "Job stored." will be displayed together with a job control number. This number can be used to locate the job in the Transaction Report or in the Image Sending Activity Report.



**System Settings for Fax (Administrator): Scan Complete Sound Setting (page 176)**

The audible signal which indicates that scanning is completed (scan complete sound) can be selected.



**To cancel scanning...**

While "Scanning original." appears in the display, press the [STOP] key (Ⓢ).



- If a fax is being received when the transmission operation is performed, the transmission will be reserved and transmitted after fax reception is completed.
- If the memory becomes full while the originals are being scanned, a message will appear and scanning will stop. If Quick Online transmission is taking place, the originals that were scanned will be transmitted. If Quick Online is not operating, the transmission will be canceled.

# USING THE AUTOMATIC DOCUMENT FEEDER TO SEND A FAX IN DIRECT TRANSMISSION MODE

1

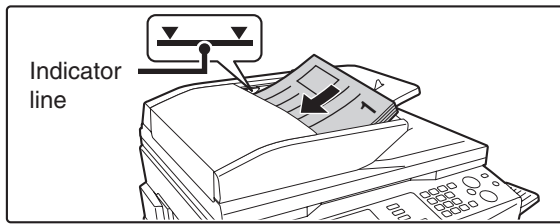

Place the originals face up in the document feeder tray with the edges aligned evenly.

Place the originals face up. Insert the originals all the way into the document feeder tray. The stack height must not be higher than the indicator line (maximum of 100 pages).

2

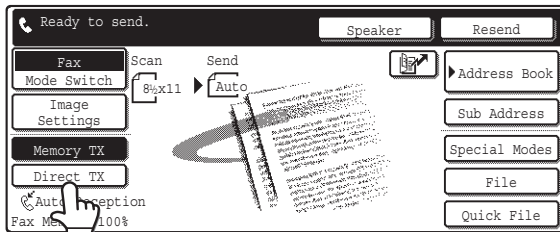

Touch the [Direct TX] key.

3

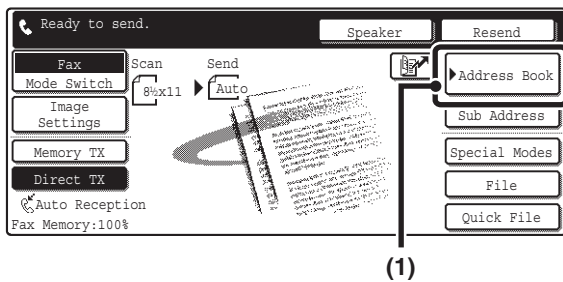

Enter the destination fax number.

- (1) Touch the [Address Book] key.
- (2) Touch the one-touch key of the desired destination.
- (3) Touch the [To] key.

CALLING UP A FAX NUMBER FROM THE ADDRESS BOOK (page 36)

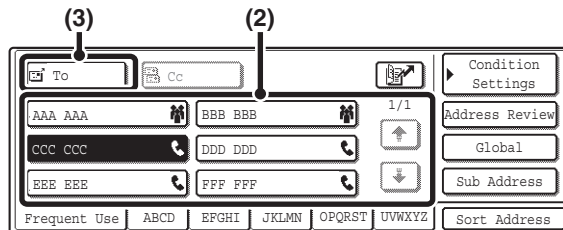

If the fax number of the transmitting machine is not stored in a one-touch key in the Address Book, enter the fax number with the numeric keys.

ENTERING A FAX NUMBER WITH THE NUMERIC KEYS (page 35)

4



Press the [BLACK & WHITE START] key (○●).

Transmission begins.



To cancel transmission...

While "Dialing. Press [STOP] to cancel" appears or while transmission is in progress, press the [STOP] key (⊘).



- Only one destination can be entered.
- The following functions cannot be used with direct transmission:  
Programs, timer transmission, 2in1, Card Shot, Job Build, Polling Memory, File, Quick File
- Resending will not take place when a direct transmission is not successful due to a communication error or other reason.
- If a fax transmission is already in progress when the direct transmission operation is performed, the direct transmission will wait until the previous transmission is finished. When the previous transmission is completed, the direct transmission will begin. While the direct transmission is waiting, the [JOB STATUS] key can be pressed to display the job status screen. No other operations are possible.

 [5. CHECKING THE STATUS OF FAX JOBS](#) (page 48)

# USING THE DOCUMENT GLASS FOR TRANSMISSION

To fax a thick original or other original that cannot be fed through the automatic document feeder, open the automatic document feeder and place the original on the document glass.

1

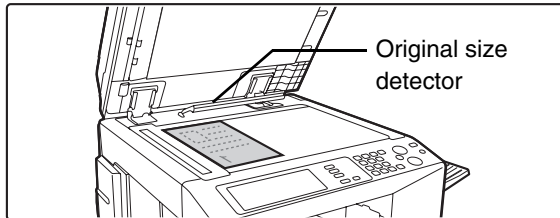

Open the automatic document feeder, place the original face down on the document glass, and then gently close the automatic document feeder.

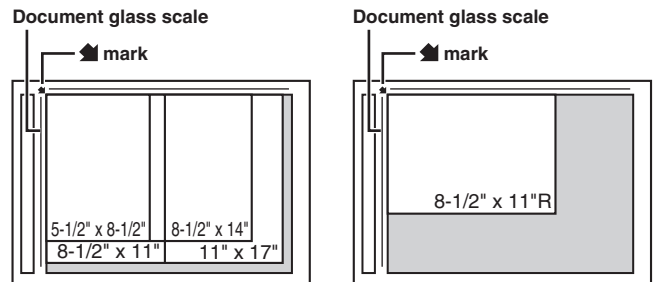

- Align the corner of the original with the tip of the arrow mark on the document glass scale.
- Place the original in the appropriate position for its size as shown above.



Do not place any objects under the original size detector. Closing the automatic document feeder with an object underneath may damage the original size detector plate and prevent correct detection of the document size.



- When faxing a multi-page original, scan each page in order starting from the first page.
- When sending a multi-page fax, the automatic document feeder and the document glass cannot both be used to scan the original pages.

2

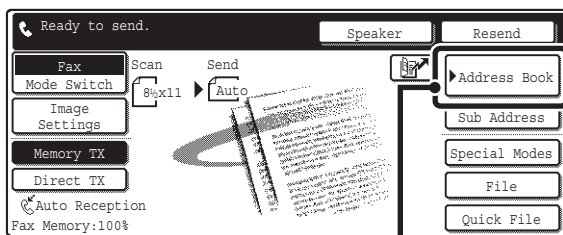

(1)

Enter the destination fax number.

- (1) Touch the [Address Book] key.
- (2) Touch the one-touch key of the desired destination.
- (3) Touch the [To] key.

[CALLING UP A FAX NUMBER FROM THE ADDRESS BOOK](#) (page 36)

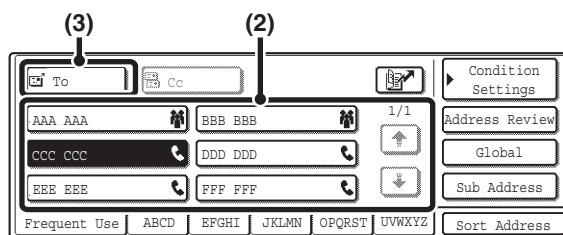

If the fax number of the transmitting machine is not stored in the Address Book, enter the fax number with the numeric keys.

[ENTERING A FAX NUMBER WITH THE NUMERIC KEYS](#) (page 35)

3

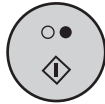

Press the [BLACK & WHITE START] key (○●).

Scanning begins.

4



If you have another page to scan, change pages and then press the [BLACK & WHITE START] key (○●).

Repeat until all originals have been scanned.



- The resolution and exposure can be changed for each original that is scanned.
- If no action is taken for one minute, scanning automatically ends and the transmission is reserved.

5

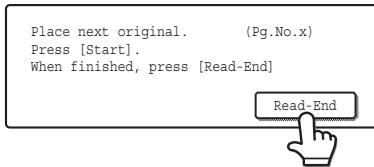

Touch the [Read-End] key.

A beep sounds.

Open the automatic document feeder and remove the original.



- When scanning is completed, "Job stored." will be displayed together with a job control number. This number can be used to locate the job in the Transaction Report or in the Image Sending Activity Report.
- If no action is taken for one minute after the confirmation screen appears, scanning automatically ends and the transmission is reserved.



**To cancel transmission...**

Press the [STOP] key (Ⓢ) before the [Read-End] key is pressed.



- If a fax is being received when the transmission operation is performed, the transmission will be reserved and transmitted after fax reception is completed.
- If the memory becomes full while the originals are being scanned, a message will appear and transmission will be canceled.

# USING THE DOCUMENT GLASS TO SEND A FAX IN DIRECT TRANSMISSION MODE

When sending a fax from the document glass in direct transmission mode, only one page can be transmitted.

1

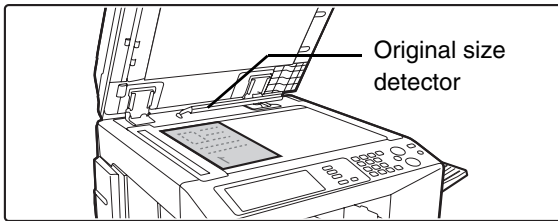

Open the automatic document feeder, place the original face down on the document glass, and then gently close the automatic document feeder.

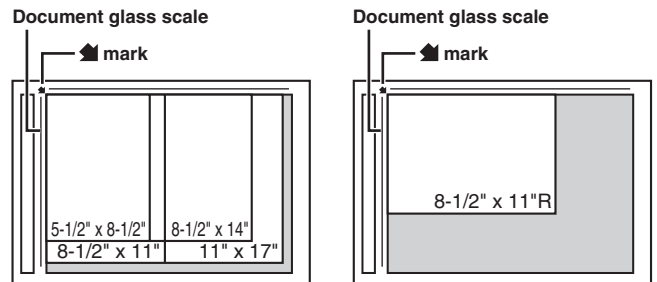

- Align the corner of the original with the tip of the arrow mark on the document glass scale.
- Place the original in the appropriate position for its size as shown above.



Do not place any objects under the original size detector. Closing the automatic document feeder with an object underneath may damage the original size detector plate and prevent correct detection of the document size.

2

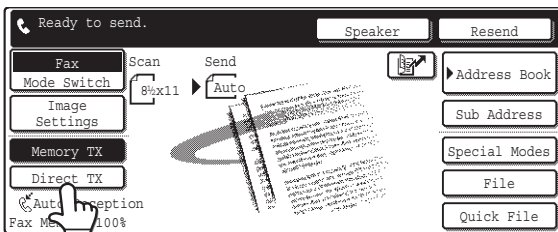

Touch the [Direct TX] key.

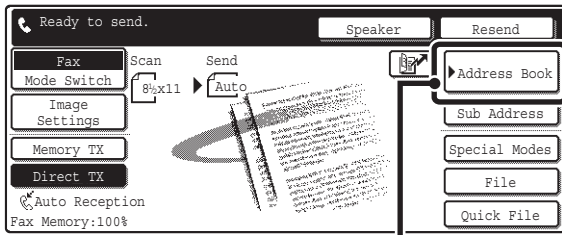

(1)

## Enter the destination fax number.

- (1) Touch the [Address Book] key.
- (2) Touch the one-touch key of the desired destination.
- (3) Touch the [To] key.

☞ [CALLING UP A FAX NUMBER FROM THE ADDRESS BOOK](#) (page 36)

If the fax number of the transmitting machine is not stored in the Address Book, enter the fax number with the numeric keys.

☞ [ENTERING A FAX NUMBER WITH THE NUMERIC KEYS](#) (page 35)

3

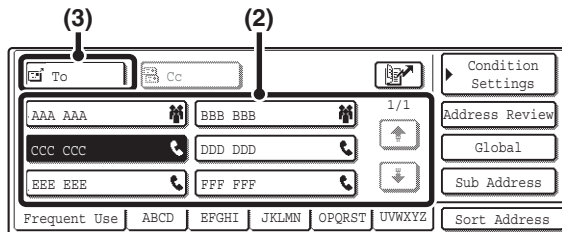

Only one destination can be entered. A one-touch key in which multiple destinations are stored (group key) cannot be used.

4



## Press the [BLACK & WHITE START] key (○●).

Transmission begins.



### To cancel transmission...

While "Dialing. Press [▽] to cancel" appears in the display, press the [STOP] key (⊙).



- The following functions cannot be used with direct transmission: Programs, timer transmission, 2in1, Card Shot, Job Build, Polling Memory, File, Quick File
- Resending will not take place when a direct transmission is not successful due to a communication error or other reason.
- If a fax transmission is already in progress when the direct transmission operation is performed, the direct transmission will wait until the previous transmission is finished. When the previous transmission is completed, the direct transmission will begin. While the direct transmission is waiting, the [JOB STATUS] key can be pressed to display the job status screen. No other operations are possible.

☞ [5. CHECKING THE STATUS OF FAX JOBS](#) (page 48)



# TRANSMISSION BY REDIALING (RESEND)

The destinations of the most recent 8 transmissions by fax, Scan to E-mail, and/or Internet fax are stored. One of these can be selected to resend to that destination.

1

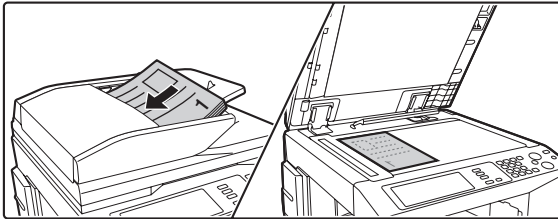

## Place the original.

Place the original face up in the document feeder tray, or face down on the document glass.

2

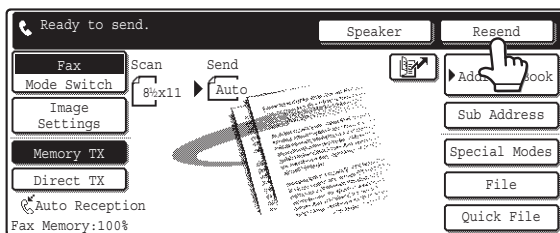

## Touch the [Resend] key.

3

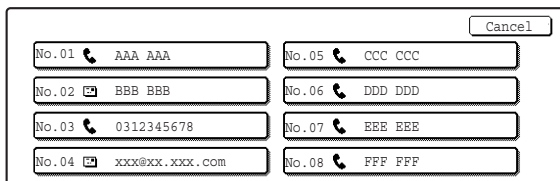

## Touch the key of the fax destination that you wish to redial.

The last eight transmission destinations appear.

4



## Press the [BLACK & WHITE START] key (○●).

Scanning begins.

- If you inserted the original pages in the document feeder tray, all pages are scanned. A beep will sound to indicate that scanning is finished.
- If you are scanning the original on the document glass, scan each page one page at a time. When scanning finishes, place the next original and press the [BLACK & WHITE START] key (○●). Repeat until all pages have been scanned and then press the [Read-End] key. A beep will sound to indicate that scanning is finished.



- If numeric keys were pressed during the previous transmission, the [Resend] key may not dial the correct number.
- Resending to destinations of a broadcast transmission or a transmission that used a program will not be possible if a one-touch key in which multiple destinations are stored (group key) was used.

# TRANSMISSION USING THE SPEAKER

When the speaker is used to dial, the fax is sent after the number is dialed and the connection is made. If a person answers, you will be able to hear his or her voice, but you will not be able to speak.

1

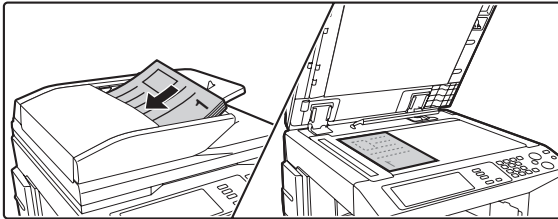

## Place the original.

Place the original face up in the document feeder tray, or face down on the document glass.

When the document glass is used, only one page can be transmitted.

2

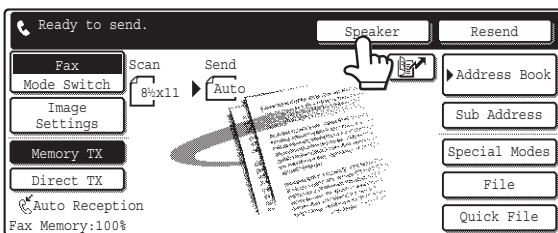

## Touch the [Speaker] key.

You will hear the dial tone through the machine's speaker.



After touching the [Speaker] key, you can touch the [Speaker Volume] key to adjust the volume of the speaker. The speaker volume changes each time the [Speaker Volume] key is touched. Adjust the volume to the desired level.

3

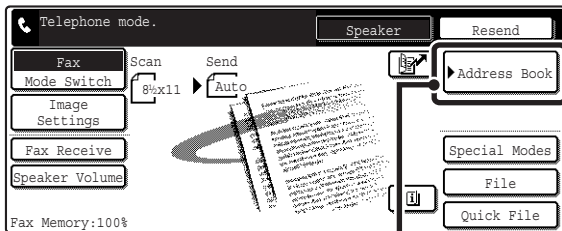

(1)

## Enter the destination fax number.

(1) Touch the [Address Book] key.

(2) Touch the one-touch key of the desired destination.

A group key cannot be used.

☛ [CALLING UP A FAX NUMBER FROM THE ADDRESS BOOK](#) (page 36)

If the fax number of the transmitting machine is not stored in the Address Book, enter the fax number with the numeric keys.

☛ [ENTERING A FAX NUMBER WITH THE NUMERIC KEYS](#) (page 35)

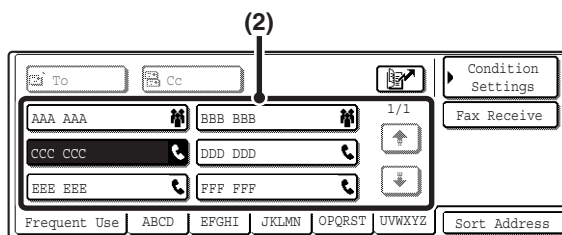

(2)

4



## Wait until the connection is made and then press the [BLACK & WHITE START] key (○●).

Transmission begins.



### To cancel transmission...

Touch the [Speaker] key before you press the [BLACK & WHITE START] key (○●). The line will be disconnected and transmission will stop.



- When the speaker is used, transmission takes place without scanning the original into memory.
- A destination that includes an F-code (sub-address and passcode) cannot be used.
- A one-touch key that has multiple destinations or has a non-fax destination cannot be used.



**System Settings for Fax (Administrator): [Speaker Settings](#) (page 178)**

The default volume level of "Speaker" can be changed in the "Speaker Settings".

# CHANGING THE RESOLUTION AND EXPOSURE

## CHANGING THE RESOLUTION

The resolution can be selected to match the characteristics of the original, such as text or photo, the size of the text, and the darkness of the image.

1

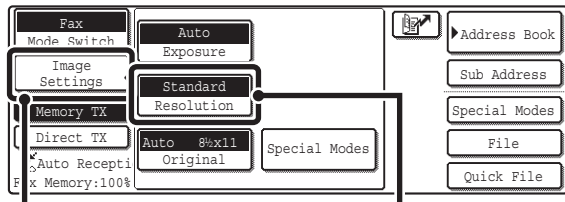

(1) (2)

**Display the resolution settings screen.**

- (1) Touch the [Image Settings] key.
- (2) Touch the [Resolution] key.

The currently configured resolution setting appears at the top of the [Resolution] key

2

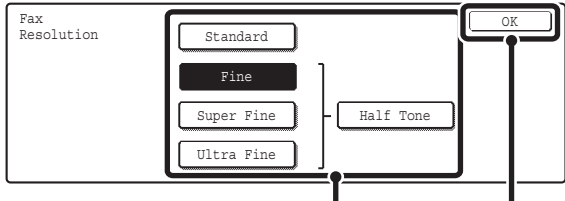

(1) (2)

**Select the resolution.**

- (1) Touch the key of the desired resolution.
- (2) Touch the [OK] key.

The resolution setting is configured and you will return to the screen of step 1.

When [Fine], [Super Fine] or [Ultra Fine] is selected, the [Half Tone] key can be touched to select halftone.

- When using the document glass to scan multiple original pages, the resolution setting can be changed each time you change pages. When using the automatic document feeder, the resolution setting cannot be changed once scanning has begun.
- When a fax is sent at [Ultra Fine], [Super Fine], or [Fine] resolution, a lower resolution will be used if the receiving machine does not have that resolution.

**System Settings for Fax (Administrator): [Initial Resolution Setting](#) (page 175)**  
This is used to change the default resolution setting.

## Resolution settings

Resolution	How to select
Standard	Select this setting when your original consists of normal-sized text (like the text in this manual).
Fine	Select this setting when your original has small text or diagrams with fine lines. The original will be scanned at twice the resolution of the [Standard] setting.
Super Fine	Select this setting when your original has intricate pictures or diagrams. A higher-quality image will be produced than with the [Fine] setting.
Ultra Fine	Select this setting when your original has intricate pictures or diagrams. This setting gives the best image quality. However, transmission will take longer than with the other settings.
Half Tone	Select this setting when your original is a photograph or has gradations of color (such as a color original). This setting will produce a clearer image than [Fine], [Super Fine], or [Ultra Fine] used alone. Halftone cannot be selected when [Standard] is used.

# CHANGING THE EXPOSURE

The exposure can be changed to match the darkness of the original.

1

**Display the exposure settings screen.**

- (1) Touch the [Image Settings] key.
- (2) Touch the [Exposure] key.

The currently configured exposure setting appears at the top of the [Exposure] key

2

**Select the exposure.**

- (1) Touch the [Manual] key.
- (2) Adjust the exposure with the keys.  
The exposure darkens when the key is touched, and lightens when the key is touched. To return to auto contrast adjustment, touch [Auto].
- (3) Touch the [OK] key.

The exposure setting is configured and you will return to the screen of step 1.

- When using the document glass to scan multiple original pages, the exposure setting can be changed each time you change pages. When using the automatic document feeder, the exposure setting cannot be changed once scanning has begun.
- System Settings for Fax (Administrator): [Default Exposure Settings](#) (page 175)**  
This is used to change the default exposure setting.

## Exposure settings

Exposure		How to select
Auto		This setting automatically adjusts the exposure for light and dark parts of the original.
Manual	1 to 2	Select this setting when the original consists of dark text.
	3	Select this setting for a normal original (neither dark nor light).
	4 to 5	Select this setting when the original consists of faint text.

---

---

# SPECIFYING THE ORIGINAL SCAN SIZE AND SEND SIZE (Enlarge/Reduce Sending)

When the original is placed, its size is automatically detected and displayed in the base screen.

When an 8-1/2" x 11" (A4) original is placed, 8-1/2" x 11" is displayed as the "Scan" size and "Auto" is displayed as the "Send" size.

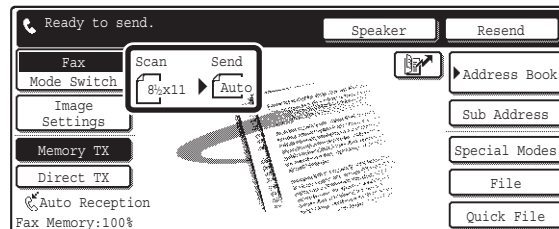

For example, if an 8-1/2" x 11" (A4) size original is placed and the send size is set to 5-1/2" x 8-1/2" (B5), the image will be reduced before transmission.

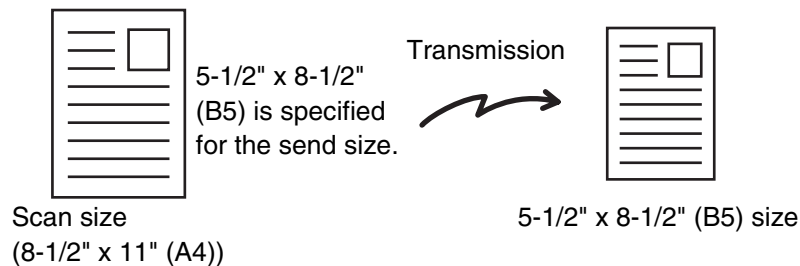

- Only standard original sizes can be automatically detected.  
➤ [STANDARD SIZES](#) (page 16)
- When the original size is a non-standard size, manually specify the original scan size.  
➤ [SPECIFYING THE SCAN SIZE OF THE ORIGINAL](#) (page 31)

# SPECIFYING THE SCAN SIZE OF THE ORIGINAL

## Specifying the size using paper sizes

1

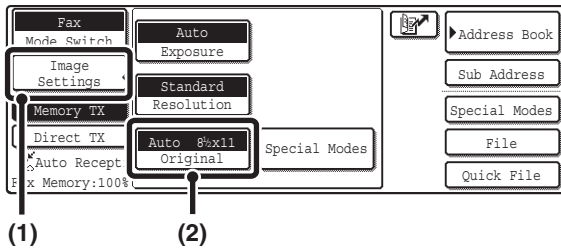

Display the original settings screen.

(1) Touch the [Image Settings] key.

(2) Touch the [Original] key.

The current status appears at the top of the [Original] key

2

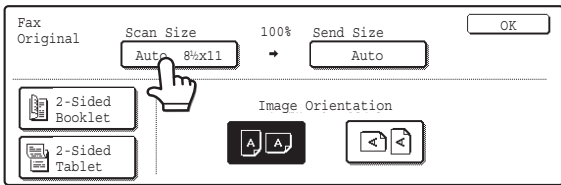

Touch the [Scan Size] key.



To specify the image orientation...

Touch the appropriate image orientation key so that it is highlighted.

3

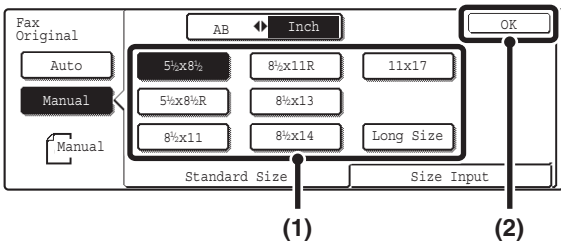

Specify the scan size.

(1) Touch the appropriate original size key.

(2) Touch the [OK] key.



- If you are sending a long original, touch the [Long Size] key.

The automatic document feeder must be used for a long original. (When the automatic document feeder is not installed, the [Long Size] key does not appear.)

An original up to 800 mm long can be transmitted. The send size cannot be specified when sending a long original.

- To specify an AB size for the scan size, touch the [AB ◀▶ Inch] key to highlight the [AB] side and then specify the scan size.

4

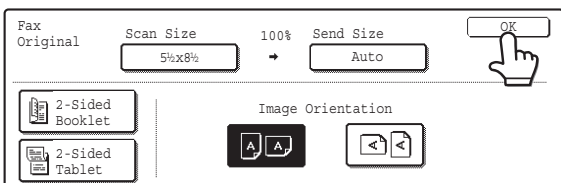

Touch the [OK] key.

# Specifying the size with numbers

**1**

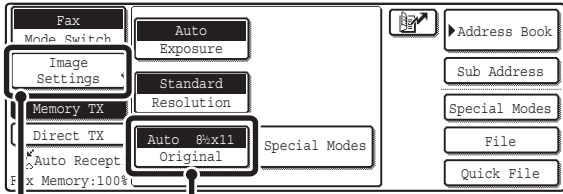

**Display the original settings screen.**

- Touch the [Image Settings] key.
- Touch the [Original] key.  
The current status appears at the top of the [Original] key

**2**

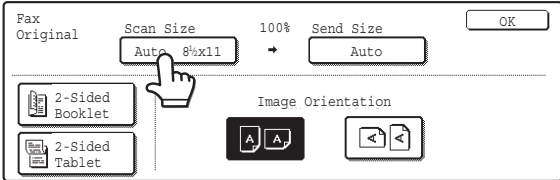

**Touch the [Scan Size] key.**

**To specify the image orientation...**  
Touch the appropriate image orientation key so that it is highlighted.

**3**

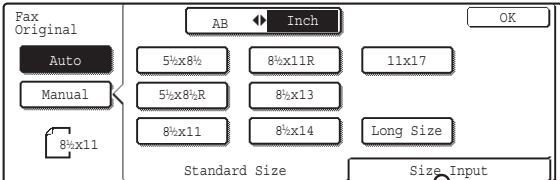

**Touch the [Size Input] tab.**

**4**

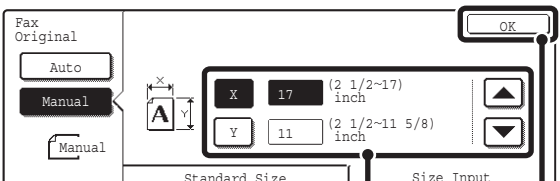

**Enter the scan size.**

- Touch the [X] key and enter the X (horizontal) dimension with the  $\downarrow$   $\uparrow$  keys.
- Touch the [Y] key and enter the Y (vertical) dimension with the  $\downarrow$   $\uparrow$  keys.
- Touch the [OK] key.

**5**

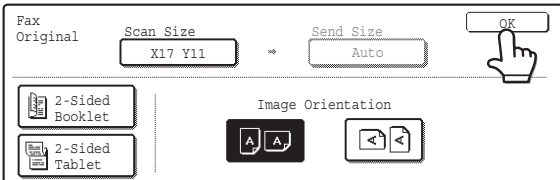

**Touch the [OK] key.**  
The specified size appears in the "Scan Size" key.

 When the scan size is specified with numbers, the send size cannot be specified.



# SPECIFYING THE SEND SIZE

Specify the send size as a paper size. If a send size bigger than the scan size is selected, the image will be enlarged. If a send size smaller than the scan size is selected, the image will be reduced. The enlargement/reduction ratio that is set using this procedure will be automatically cleared after the transmission is completed.



The send size cannot be specified when the scan size is [Long Size] or is specified by numbers.

1

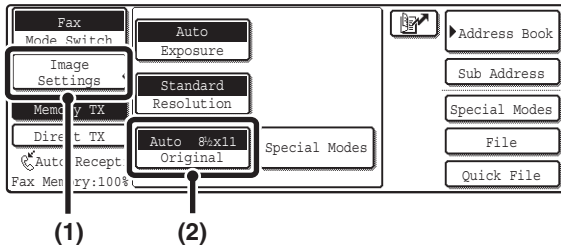

**Display the original settings screen.**

- (1) Touch the [Image Settings] key.
- (2) Touch the [Original] key.

2

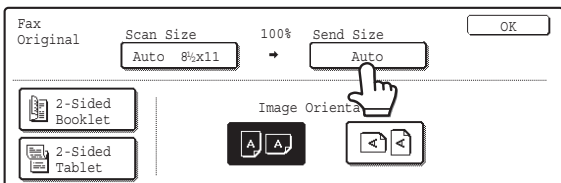

**Touch the [Send Size] key.**

3

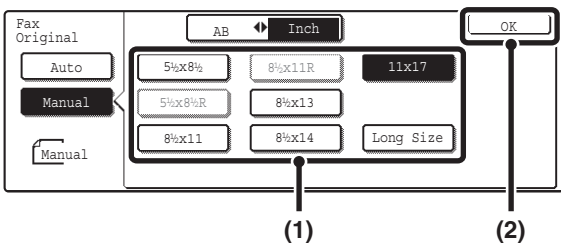

**Specify the send size.**

- (1) Touch the desired send size key.
- (2) Touch the [OK] key.



- Depending on the paper size specified for the "Scan Size", it may not be possible to select some sizes for the "Send Size". Size keys that cannot be specified for the "Send Size" are grayed out to prevent selection.
- To specify an AB size for the send size, touch the [AB ◀▶ Inch] key to highlight the [AB] side and then specify the send size.

4

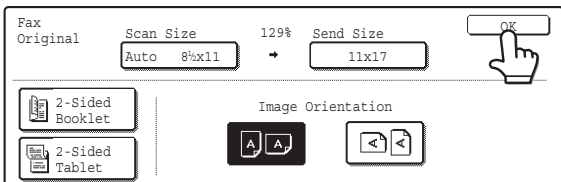

**Touch the [OK] key.**

The enlargement/reduction ratio appears between the "Scan Size" key and the "Send Size" key.

# AUTOMATICALLY SCANNING BOTH SIDES OF AN ORIGINAL (2-sided original)

This function is convenient when you wish to fax both sides of a document. The automatic document feeder will automatically scan both sides of the document.

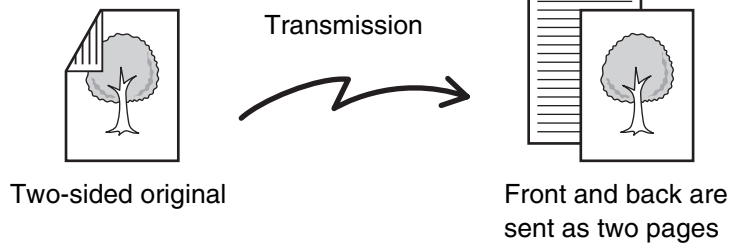

1

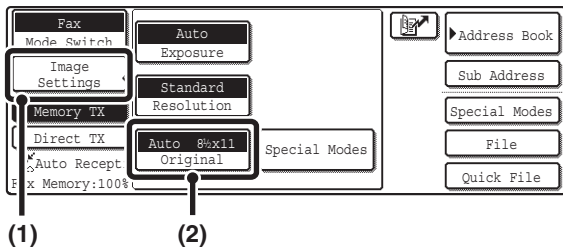

**Display the original settings screen.**

- (1) Touch the [Image Settings] key.
- (2) Touch the [Original] key.

2

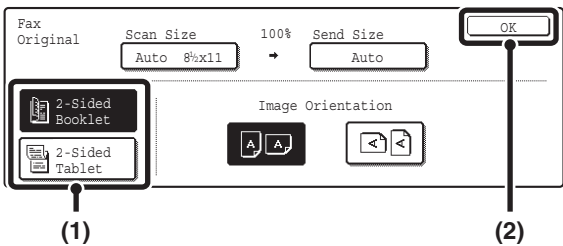

**Select the 2-sided original setting.**

- (1) Touch the [2-Sided Booklet] key or the [2-Sided Tablet] key.

A booklet and a tablet are bound as shown below.

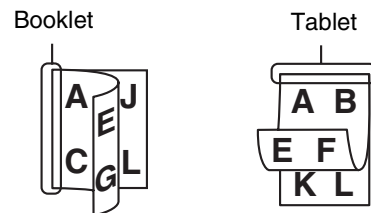

- (2) Touch the [OK] key.



**To specify the image orientation...**

Touch the appropriate original orientation key so that it is highlighted.



Two-sided scanning automatically turns off after the transmission operation is completed.

# 3

## ENTERING DESTINATION FAX NUMBERS

This chapter explains how to enter destination fax numbers.

Destination fax numbers can be entered using the numeric keys, or by calling up a previously stored fax number using the Address Book or a search number.

---

---

### ENTERING A FAX NUMBER WITH THE NUMERIC KEYS

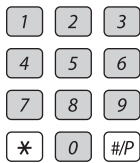

Enter the destination fax number with the numeric keys.



Take care to enter the correct number.



**If an incorrect number is entered...**

Press the [CLEAR] key (C) to clear the number and enter the correct number.

### Entering a pause between digits of the number

Enter a pause after the number used to dial out from a PBX (for example, after "0"), or after the country code when dialing an international number.

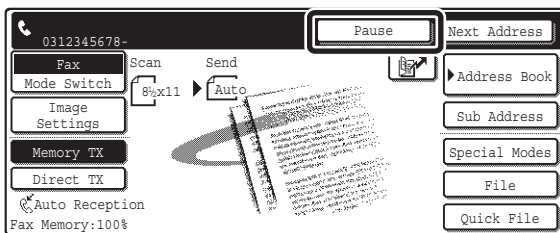

Touch the [Pause] key.

A hyphen "-" is entered when the [Pause] key is touched once.



**System Settings for Fax (Administrator): [Pause Time Setting](#) (page 178)**

This is used to set the length of pauses. The default setting is 2 seconds.

# CALLING UP A FAX NUMBER FROM THE ADDRESS BOOK

The Address Book screen shows destinations as one-touch keys.

A destination fax number is called up by simply touching the one-touch key of that destination. This is called "one-touch dialing". It is also possible to store multiple fax numbers in a one-touch key, allowing you to call up all the numbers by simply touching the key. This is called "group dialing". This dialing method is convenient when you wish to send a fax to (or poll) multiple fax destinations.

One-touch keys are grouped on alphabetical index tabs to make it easy to find a destination.

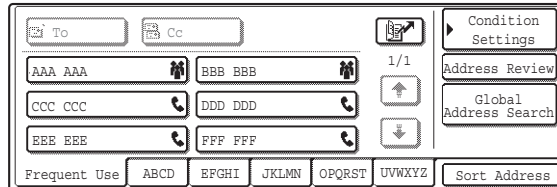

When destinations of other scan modes are stored in addition to fax destinations, an icon indicating the mode appears together with the name of the destination in each one-touch key.

Icon	Mode
	Fax
	When multiple destinations are stored
	Scan to E-mail
	Internet Fax
	Scan to FTP
	Scan to Network Folder
	Scan to Desktop

## Index display

One-touch keys are grouped by initial on alphabetical index tabs.

To display a one-touch key, touch the index tab that corresponds to the first letter of the name of the one-touch key. Frequently used destinations can be displayed on the [Frequent Use] tab.

- Destinations are automatically assigned to tabs when they are stored in one-touch keys. To have a destination appear on the [Frequent Use] tab, select this setting when you store the one-touch key.
  - [Storing a One-touch \(Individual\) Key for Fax](#) (page 135)

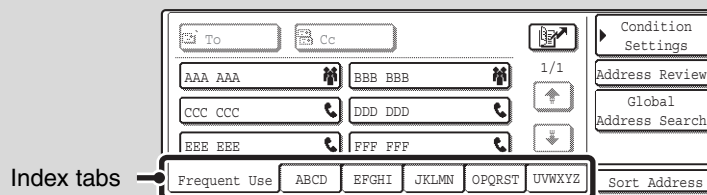

It is also possible to create custom indexes that are not based on alphabetical order. A name can be assigned to each created index and destinations grouped in the index as desired (custom index).

- Use the system settings to create and store custom indexes
  - [Changing the Name of a Custom Index](#) (page 159)
  - [Storing a One-touch \(Individual\) Key for Fax](#) (page 135)
- To use a custom index, change the Address Book display.
  - [CHANGING THE INDEX](#) (page 40)

## System Settings for Fax: Address/Program

This is used to store destinations (names and fax numbers) in the Address Book.

- [Storing a One-touch \(Individual\) Key for Fax](#) (page 135), [Storing a Group Key](#) (page 140)

# CALLING UP A STORED DESTINATION

Follow the steps below to select a destination from the Address Book.

1

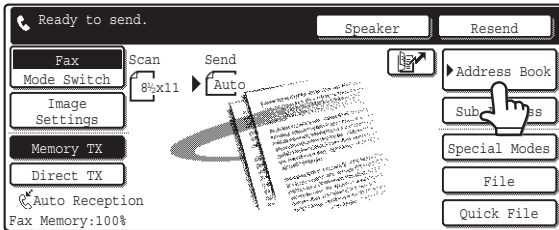

**Touch the [Address Book] key.**

The address book screen will appear.

2

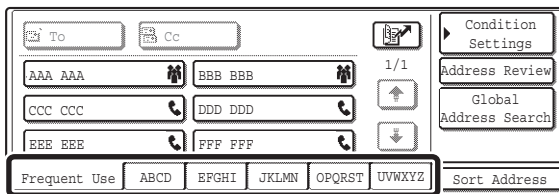

**Touch the index tab of the first letter of the destination name.**



Frequently used destinations can be displayed in the [Frequent Use] index. Specify that a destination be displayed in the [Frequent Use] index when you store the destination.

3



It is possible to display the destinations in alphabetical order by name. Each time the displayed index tab is touched, the display order changes in the following order: search numbers (page 43), ascending names, descending names, search numbers... When the display order is changed, the display order of the other index tabs also changes.

Ordered by search number (default)

Ascending names

Descending names



4

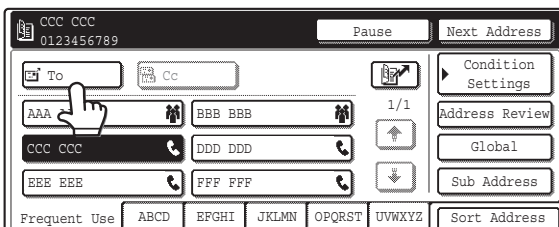

**Touch the [To] key.**

This enters the selected destination.



**To select additional destinations...**  
Touch the [To] key and repeat the procedure from step 2.

# CHECKING AND DELETING ENTERED DESTINATIONS

When multiple destinations have been entered, you can display and check the destinations. You can also remove a destination from the list of selected destinations.

1

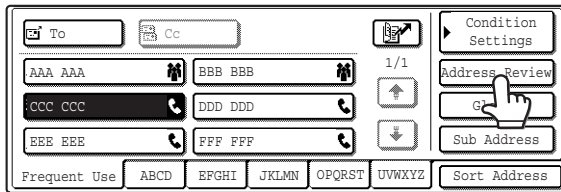

Touch the [Address Review] key.

2

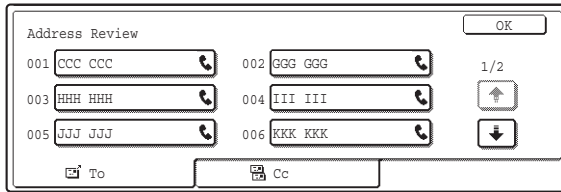

Check the destinations.



**To cancel an entered destination...**

Touch the key of the destination that you wish to cancel. Touch the [Yes] key in the confirmation screen.

3

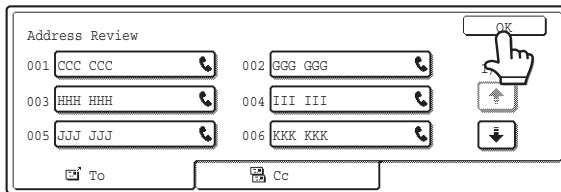

Touch the [OK] key.

You will return to the Address Book screen.

# DISPLAYING ONLY FAX OR GROUP DESTINATIONS

You can change the Address Book screen to show only one-touch keys that have fax destinations stored or one-touch keys that have multiple destinations stored. The procedure for selecting destinations does not change.

**1**

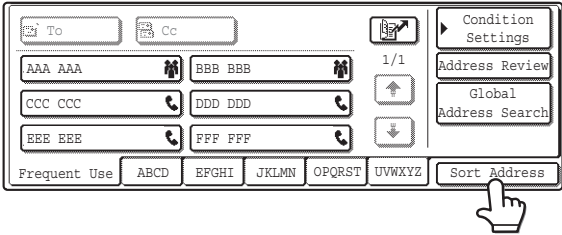

The screenshot shows the Address Book interface. At the top, there are fields for 'To' and 'Cc', and a '1/1' indicator. Below these are several contact entries, each with a name and a phone icon. At the bottom, there is a 'Sort Address' key. A hand icon is pointing to this key.

**Touch the [Sort Address] key.**

**2**

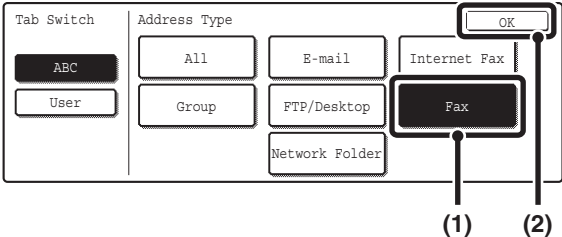

The screenshot shows the 'Address Type' selection screen. It has a 'Tab Switch' section with 'ABC' and 'User' options. The 'Address Type' section contains several buttons: 'All', 'E-mail', 'Internet Fax', 'Fax', 'FTP/Desktop', and 'Network Folder'. The 'Fax' button is highlighted. An 'OK' button is at the top right. Arrows labeled (1) and (2) point to the 'Fax' and 'OK' buttons respectively.

**Change the display method.**

- (1) Touch the [Fax] key.**
- (2) Touch the [OK] key.**



**To display only group one-touch keys...**  
Touch the [Group] key.

# CHANGING THE INDEX

The index displayed in the Address Book screen can be changed to a custom index.

**1**

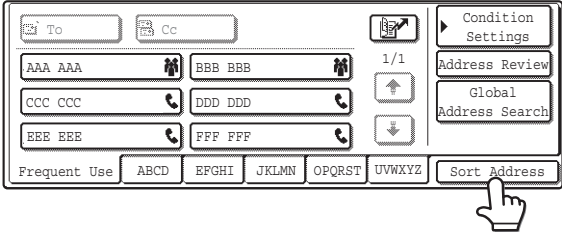

The screenshot shows the Address Book interface. At the top, there are fields for 'To' and 'Cc', and a '1/1' indicator. Below these are several address entries, each with a phone icon. On the right side, there are buttons for 'Condition Settings', 'Address Review', and 'Global Address Search'. At the bottom, there is a row of keys: 'Frequent Use', 'ABCD', 'EFGHI', 'JKLMN', 'OPQRST', 'UVWXYZ', and 'Sort Address'. A hand icon is pointing to the 'Sort Address' key.

**Touch the [Sort Address] key.**

**2**

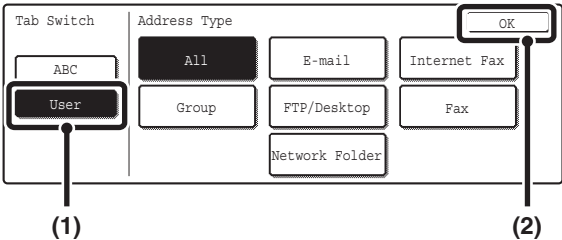

The screenshot shows the 'Address Type' dialog box. It has two main sections: 'Tab Switch' and 'Address Type'. Under 'Tab Switch', there are buttons for 'ABC' and 'User'. Under 'Address Type', there are buttons for 'All', 'E-mail', 'Internet Fax', 'Group', 'FTP/Desktop', 'Fax', and 'Network Folder'. An 'OK' button is located at the top right. A hand icon is pointing to the 'User' button, labeled with '(1)'. Another hand icon is pointing to the 'OK' button, labeled with '(2)'.

**Change to the custom index.**

(1) Touch the [User] key.  
(2) Touch the [OK] key.



## System Settings for Fax: Custom Index

This is used to create a custom index. Display of a destination on the index is selected when the destination is stored.

[Changing the Name of a Custom Index](#) (page 159)



# CALLING UP A DESTINATION FROM A GLOBAL ADDRESS BOOK

If an LDAP server that has fax numbers is configured in the Web pages, you can look up a destination fax number in a global address book.

1

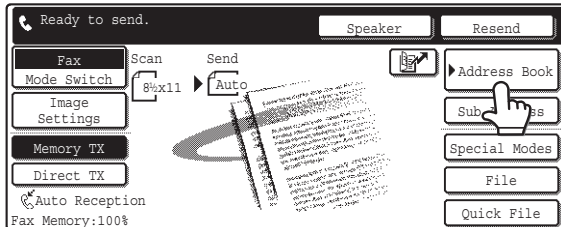

Touch the [Address Book] key.

2

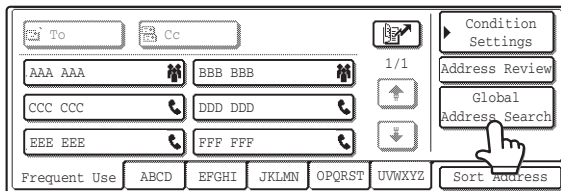

Touch the [Global Address Search] key.



If only one LDAP server is configured, the global address search screen will appear. Go to step 4.

3

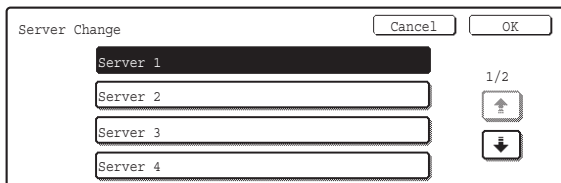

Search for the destination.

**(1) Select the LDAP server.**

Touch the key of the LDAP server that you wish to use and then touch the [OK] key.

**(2) Search for the destination on the text entry screen that will appear.**

Enter the initial letters of the name of the destination and touch the [Search] key. The results will appear after a brief interval.

For the procedure for entering text, see "6. ENTERING TEXT" in the User's Guide.



• How to search

Enter the initial letters of the name (maximum of 64 characters). The system will look for names starting with the entered letters.

An asterisk \* can be used as follows:

\*XXX: Names that end with "XXX".

\*XXX\*: Names that include "XXX".

AA\*XX: Names that start with "AA" and end with "XX".

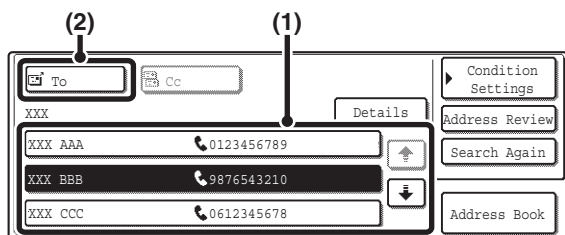

## Select the destination.

(1) Touch the key of the desired destination.

(2) Touch the [To] key.

This enters the selected destination.

If you wish to enter another destination, repeat steps (1) and (2) above.



- The number of characters that can appear in a destination key is 20 characters for a name or 22 digits for a fax number.
- If no names are found that match the search letters, a message will appear. Touch the [OK] key in the message to change the screen and touch the [Search Again] key to search again.
- If more than 30 matches are found, a message will appear in the screen. Touch the [OK] key to close the message. A maximum of 300 search results are displayed. If the desired destination was not found, touch the [Search Again] key to add more search letters.
- **To check the information stored in a destination...**
  - (1) Touch the key of the destination that you wish to check.
  - (2) Touch the [Details] key.  
The stored information appears.
  - (3) Touch the [OK] key.  
You will return to the search results screen.
- **If a screen for selecting the item to be used appears...**  
If the selected destination includes an E-mail address or other address in addition to the fax number or telephone number, you will need to select which item you wish to use. Touch the [Fax] key to retrieve the fax number.
- The [Details] key can be touched to display information on the selected destination. To store the selected destination in the Address Book, touch the [Register] key.

# USING A SEARCH NUMBER TO CALL UP A DESTINATION

A destination stored in one-touch key in the Address Book can be called up using the  key. This can be done in the base screen of fax mode or in the Address Book screen.

1

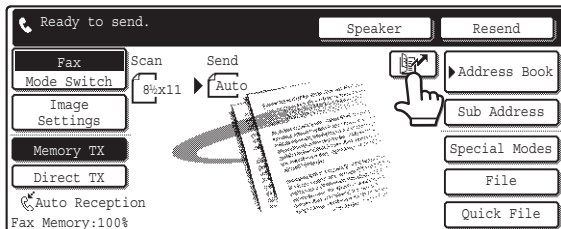

Touch the  key.

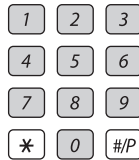

2



**Enter the 3-digit search number of the destination with the numeric keys.**

When the 3-digit search number is entered, the stored destination is retrieved.



- The search number is programmed when the destination is stored in a one-touch key.
- If you do not know the search number, print the one-touch address list using "Sending Address List" in the system settings for fax.  
 [Sending Address List](#) (page 134)
- When entering search numbers such as "001" and "011", "0" can be omitted. For example to enter "001", enter "1" and touch the  key or the [Next Address] key.



**If an incorrect search number is entered...**

Press the [CLEAR] key () to clear the number and enter the correct number.

---

---

# CHAIN DIALING

Number sequences entered with the numeric keys and/or one-touch keys can be linked together with pauses and dialed as a single number.

Use chain dialing to dial a long number (such as an international number) when the country code and/or area code are stored separately in one-touch keys.

## Example: Using chain dialing to dial an international number

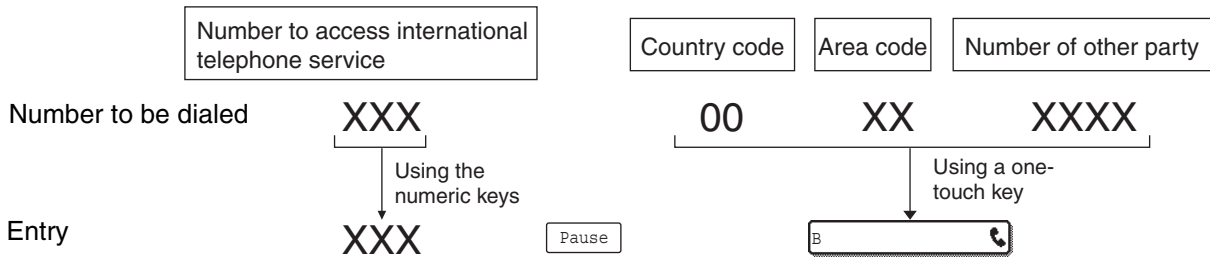

Pauses can be omitted before and after a number entered with a one-touch key or the key. A pause cannot be omitted between number sequences entered with the numeric keys.

**System Settings for Fax (Administrator): [Pause Time Setting](#) (page 178)**  
This is used to set the length of pauses. The default setting is 2 seconds.

# 4 FAX RECEPTION

This chapter explains the basic procedures for receiving a fax.

## RECEIVING FAXES

When "Auto Reception" is enabled, the machine will receive faxes automatically. The fax reception mode is displayed in the base screen.

This shows the current fax reception mode and the amount of free memory remaining.



- When fax reception is in progress, it is possible to reserve a transmission by performing the transmission in memory transmission mode.  
➤ [TRANSMISSION METHODS](#) (page 13)
- To print received faxes, make sure that the required paper is loaded in the machine's paper trays. It is not necessary to load 8-1/2" x 11" (A4) paper and 5-1/2" x 8-1/2" (B5) paper in both the vertical (📄) and horizontal (📄) orientations. Differences in orientation are automatically adjusted when faxes are received. When a fax smaller than 8-1/2" x 11" (A4) size is received, the size of the paper used for printing will vary depending on the orientation (vertical or horizontal) in which the sender placed the original.
- **System Settings for Fax: Fax Receive Settings**  
This is used to change the fax reception mode. "Auto Reception" should normally be used. Select "Manual Reception" when an extension phone is connected to the machine.  
➤ [Fax Receive Settings](#) (page 160)
- **System Settings for Fax (Administrator): Anti Junk Fax Setting (page 183)**  
This setting is used to enter fax numbers from which you wish to block reception.

# RECEIVING A FAX

When a fax is transmitted to the machine, the machine automatically receives and prints the fax.

1

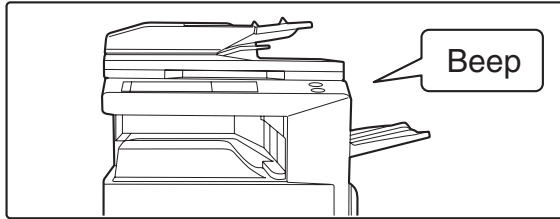

## The machine rings and automatically receives the fax.

When reception ends, a beep sounds.



- **System Settings for Fax (Administrator): [Speaker Settings](#) (page 178)**  
This is used to change the volume and tone of the reception beep.
- **System Settings for Fax (Administrator): [Number of Calls in Auto Reception](#) (page 182)**  
This is used to change the number of rings on which fax reception begins automatically. To receive faxes without the machine ringing, select "0" rings except for some regions.

2

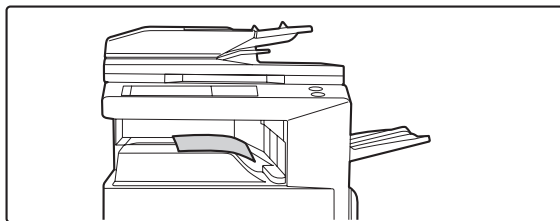

## The fax is automatically printed.



- **If a password entry screen appears...**  
A password must be entered to print the received fax. When the correct password is entered, the received fax is printed.  
➤ [PRINTING A PASSWORD-PROTECTED FAX \(Hold Setting For Received Data Print\)](#) (page 47)
- **The output tray and stapling can be selected (when a finisher is installed).**  
The number of copies of received faxes that are printed and the output tray can be selected. When a finisher is installed, the number of copies printed, the output tray, and stapling can be selected.  
➤ System Settings for Fax (Administrator): [Fax Output Settings](#) (page 184)



- If printing of a copy job or print job is in progress when a fax is received, the fax will not be printed until the previously reserved job is completed.
- Received faxes will not be printed when the machine cannot print due to an error condition such as out of paper, out of toner, or a paper misfeed. The faxes will be printed automatically when the error condition is cleared.
- When received faxes cannot be printed, the faxes can be forwarded to another fax machine.  
➤ [FORWARDING RECEIVED FAXES \(Fax Data Forward\)](#) (page 101)



- **System Settings for Fax (Administrator): [Duplex Reception Setting](#) (page 182)**  
This is used to have received faxes printed on both sides of the paper.

# PRINTING A PASSWORD-PROTECTED FAX (Hold Setting For Received Data Print)

You can turn off automatic printing of received faxes (Hold Setting for Received Data Print). When this function is enabled, received faxes will not be printed automatically; a password entry screen will appear instead.

## Password entry screen

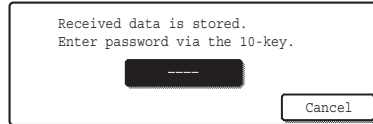

To print a received fax, enter the password that is programmed for this function (4 digits) with the numeric keys. To close the password entry screen without entering a password, touch the [Cancel] key. The password entry screen will appear again if the mode is changed.

In addition, after the [Cancel] key is touched to close the screen, the  key will blink in the base screen as a reminder that a received fax is being held.

Touch the blinking  key to enter the password and print the fax.



"Hold Setting for Received Data Print" can be enabled for received faxes and also for transaction reports that are printed with the received faxes.



**System Settings for Fax (administrator):** [Hold Setting for Received Data Print \(page 176\)](#)

This is used to program a password for printing of received faxes.

# 5

# CHECKING THE STATUS OF FAX JOBS

This chapter explains how to check the status of reserved transmission jobs and received faxes.

## JOB STATUS SCREEN

The job status screen is displayed when the [JOB STATUS] key on the operation panel is pressed. The job status screen shows the status of jobs by mode. When the [JOB STATUS] key is pressed, the job status screen of the mode that was being used before the key was pressed appears.

**Example: Pressing the key in fax mode**

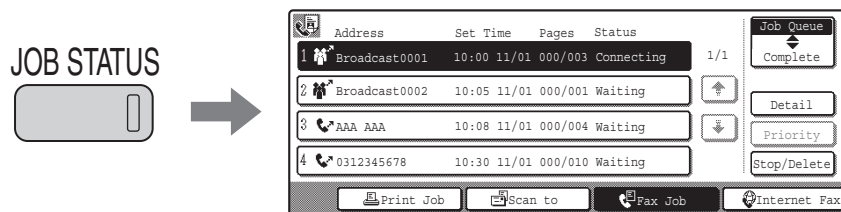

Reserved transmissions and received faxes are referred to as jobs here.

 The left edge of the job status screen appears at the left edge of the touch panel screen. The left edge of the job status screen can be touched to display the job status screen.

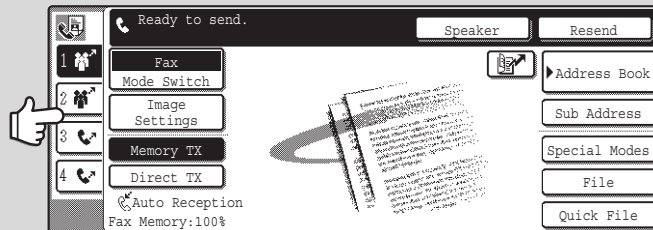



# JOB QUEUE SCREEN AND COMPLETED JOB SCREEN

The job status screen consists of two screens: the job queue screen that shows reserved jobs and the job currently in progress, and the completed jobs screen. To switch between the two screens, touch the job status screen selector key ((3) below).

## Job queue screen

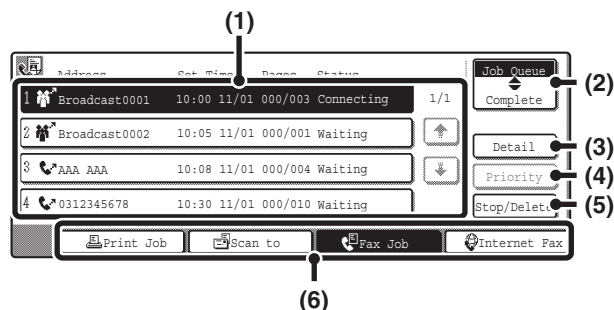

## Completed job screen

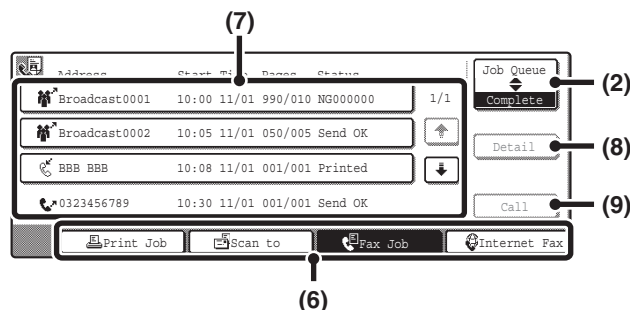

### (1) Job queue screen

Jobs are shown as keys in the order they were reserved. Each key shows information on the job and its current status.

### (2) Job status screen selector key

Touch this key to switch between the job queue screen and the completed jobs screen.

### (3) Job queue screen [Detail] key

The detailed contents of a broadcast transmission or serial polling job reserved or in progress can be displayed.

Touch the key of the desired broadcast transmission job in the job queue screen (1) and then touch this key.

☞ [CHECKING A RESERVED JOB OR THE JOB IN PROGRESS](#) (page 53)

### (4) [Priority] key

Touch this key to give priority to a selected job.

☞ [GIVING PRIORITY TO A RESERVED FAX JOB](#) (page 56)

### (5) [Stop/Delete] key

Touch this key to stop or delete a selected job.

☞ [CANCELING A FAX IN PROGRESS OR A RESERVED FAX](#) (page 55)

### (6) Mode switch keys

Use these keys to change the job status screen mode.

### (7) Completed jobs screen

This shows up to 99 completed transmission or reception jobs. A description of the job and the result (status) are shown.

Broadcast transmission jobs, serial polling jobs, and transmission/reception jobs that used the document filing function are indicated as keys.

### (8) Completed jobs screen [Detail] key

This shows detailed information on the results of completed broadcast transmission jobs, completed serial polling jobs, and completed jobs that used the document filing function.

Touch the key of the desired job in the completed jobs screen (7) and then touch this key.

From the details screen, it is possible to resend the fax to destinations to which transmission was not successful.

☞ [CHECKING COMPLETED JOBS](#) (page 54)

### (9) [Call] key

Touch this key to call up and use a transmission or reception job stored using the document filing function.

# Items displayed in keys in the job queue

The following information appears in the keys in the job queue of the job status screen.

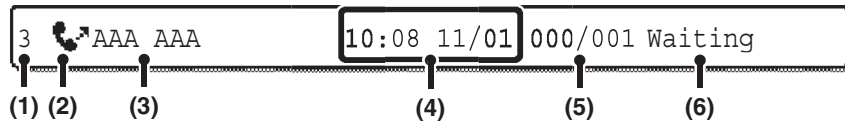

- (1) **Displays the number (position) of the job in the job queue.**  
When the job currently being transmitted is finished, each job moves up one position in the job queue.

- (2) **Mode icon**  
This indicates the type of job.

Icon	Job type
	Fax transmission
	Fax reception
	Broadcast transmission or serial polling
	PC-Fax transmission

- (3) **Name of other party**  
For a transmission, the name or fax number of the destination. For a reception, the fax number of the sending party.  
For a broadcast transmission or serial polling operation, the function name and a broadcast control number (4-digits).

- (4) **Job reservation time**  
The date and time the job was reserved.

- (5) **Number of pages**  
Shows the number of pages transmitted / total number of original pages.

- (6) **Status**  
Shows the job status.
  - Job in progress

Message	Status
"Connecting"	Connecting
"Sending"	Sending
"Receiving"	Receiving
"Tel"	An extension phone is being used to talk with the other party.
"Stopped"	The job has been stopped.
"Error"	An error occurred while the job was being executed.

- Job waiting to be executed

Message	Status
"Waiting"	The job is waiting to be executed.
"Retry"	The job is being re-attempted due to a communication error or other problem.
"Stopping"	The job is put on stop-wait when a reserved fax job is cancelled.
The day and time are displayed.	Timer transmission job (the specified time is displayed)

# Items displayed in keys of completed jobs

The following information appears in the keys of completed jobs in the job status screen.

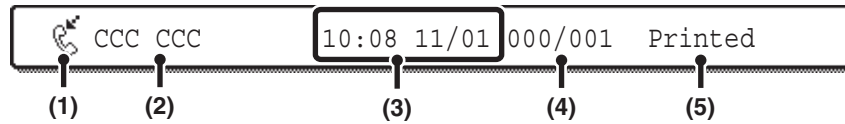

**(1) Mode icon**

This indicates the type of job.

Icon	Job type
	Fax transmission
	Fax reception
	Broadcast transmission or serial polling
	PC-Fax transmission

**(2) Name of other party**

For a transmission, the name or fax number of the destination. For a reception, the fax number of the sending party.

For a broadcast transmission or serial polling operation, the function name and a broadcast control number (4-digits).

**(3) Start time**

The date and time the job was begun.

**(4) Number of pages**

Shows the number of pages transmitted / total number of original pages.

**(5) Status**

Shows the job status.

- Completed job

Message	Status
"Send OK"	Transmission completed.
"In Memory"	Reception completed but the fax has not been printed.
"Printed"	The received fax has been printed.
"Forward OK"	The received fax has been forwarded.
"Stopped"	The job was stopped.
"Holding"	The received fax is being held by the print hold function.
"Number of successful transmission destinations / Total destinations OK"	Broadcast transmission or serial polling completed. If transmission to 3 destinations was successful out of a total of 5, "003/005" will appear.
"No response"	An error occurred because there was no response from the destination.
"Busy"	An error occurred because the other party was busy.
"Reject Reception"	A fax was sent from a party that has been blocked by the anti junk fax function.
"NGxxxxxx"	Transmission/reception was not successful because a communication error occurred (a 6-digit error code appears in xxxxxx.)
"Error"	An error occurred while the job was being executed.

# OPERATION WHEN A JOB IN THE JOB QUEUE IS COMPLETED

When a normal transmission job is completed, it moves to the completed jobs screen and "Send OK" appears in the status column.

Received faxes, timer transmission jobs, retry jobs, and forwarding jobs are handled in the job status screen as explained below.

## Fax reception jobs

While a fax is being received, "Receiving" appears in the job queue screen.

When reception is completed, the job moves to the completed jobs screen and "In Memory" appears.

After the fax is printed, the status changes to "Printed".

## Timer transmission jobs

A timer transmission job appears at the bottom of the job queue screen until the specified time arrives.

When the specified time arrives, the job is executed. If another job is in progress, the timer job is started when the other job is completed.

## Retry jobs

A retry job appears at the bottom of the job queue screen. When the set retry interval elapses, the job is executed. If there are jobs reserved ahead of the retry job, the retry job is reserved at the bottom of the job queue and executed when its turn arrives.

## Fax reception jobs when Inbound Routing is enabled

When Inbound Routing is enabled in the Web pages, fax reception jobs are handled as follows depending on the print setting.

 [FORWARDING A RECEIVED FAX TO AN E-MAIL ADDRESS \(Inbound Routing Settings\)](#) (page 104)

- **Received fax is not printed**

"Receiving" appears in the job queue screen while the fax is being received. When reception is completed, the job moves to the job queue of the status screen of the mode in which forwarding is enabled.

- **Received fax is printed**

When reception is completed, the job moves to the completed jobs screen and "In Memory" appears. After the fax is printed, "Printed" appears. In addition, the job is added to the job queue of the job status screen of the mode in which forwarding is enabled. When forwarding received faxes is finished, "Forward OK" appears.

# CHECKING A RESERVED JOB OR THE JOB IN PROGRESS

The detailed contents of a broadcast transmission or serial polling job can be displayed. Select (touch) the key of the job that you wish to check and touch the [Details] key. The job details screen will appear (see below).

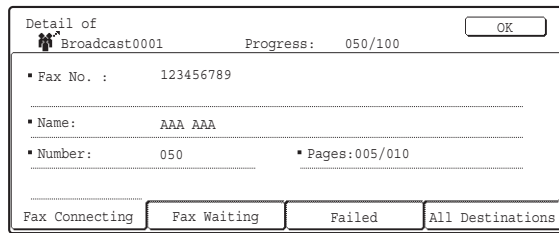

The job name and progress (number of completed destinations / total destinations) appear at the top of the screen. Touch a tab to display the information that appears on that tab. The following information appears on each tab.

Tab name	Contents
Fax Connecting	Information on the current destination appears. Fax No.: The fax number of the destination. Name: The name of the destination. Number: The broadcast control number (3 digits). Pages: Number of pages completed / total number of pages
Fax Waiting	This shows information on the destinations that are waiting. A broadcast control number (3-digits) appears in front of each destination. Address: The name of the other destination. Status: The status of communication.
Failed	This shows information on destinations for which communication failed. A broadcast control number (3-digits) appears in front of each destination. Address: The name or fax number of the destination. Start Time: The time when communication began. Status: The status of communication.
All Destinations	This shows all destinations specified in the job. A broadcast control number (3-digits) appears in front of each destination. Address: The name or fax number of each destination. Start time: The time at which communication began. Status: The status of communication.

# CHECKING COMPLETED JOBS

You can check a list of the destinations, the destinations for which transmission failed, and other detailed information on completed broadcast transmission jobs and serial polling jobs, and jobs that used document filing. Touch the key of the desired job in the completed jobs screen and touch the [Detail] key. The job detail screen (see below) will appear.

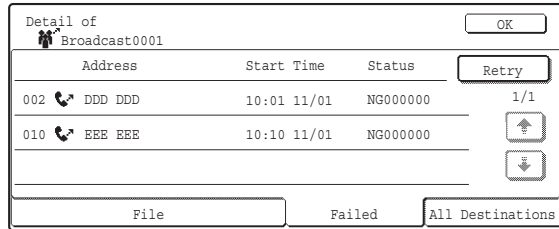

The job name appears at the top of the job detail screen.

To view details on the job, touch one of the tabs. The following information appears on each tab.

Tab name	Information displayed
File	Information on a transmission/reception that used document filing. To call up the file and use it, touch the [Call] key.
Failed	Shows information on destinations for which communication failed. A broadcast control number (3-digits) appears in front of each destination. Address: Address name or number Start time: Time at which communication began. Status: Description of failure (error) The [Retry] key can be touched to re-attempt transmission to that destination.
All Destinations	Shows all addresses specified in the job. A broadcast control number (3-digits) appears in front of each destination. Address: Address name or number Start time: Time at which communication began. Status: Communication result The [Retry] key can be touched to transmit to all destinations again.

# CANCELING A FAX IN PROGRESS OR A RESERVED FAX

Follow the steps below to cancel a fax transmission that is in progress or a reserved fax job.

**1** **JOB STATUS**  Press the [JOB STATUS] key.

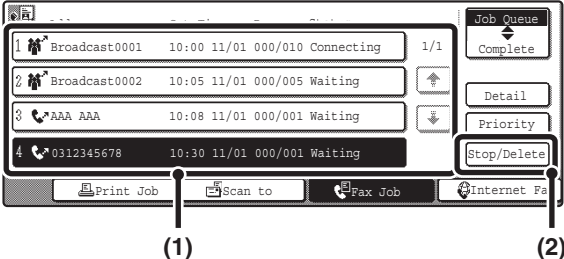
**2**  Select the fax job that you wish to cancel.  
 (1) Touch the key of the fax job to be canceled.  
 (2) Touch the [Stop/Delete] key.

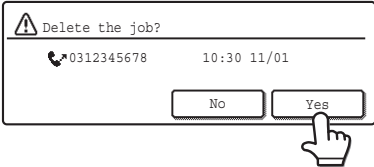
**3**  Touch the [Yes] key.

 If you do not wish to cancel the selected fax job... Touch the [NO] key.

 • When a reserved fax job is canceled, "Stopping" appears and the job is put on stop-wait. When the stop-wait job reaches the top of the job queue, it is deleted.  
 • If you cancel a fax job in progress, touch the [Yes] key to confirm the cancellation.

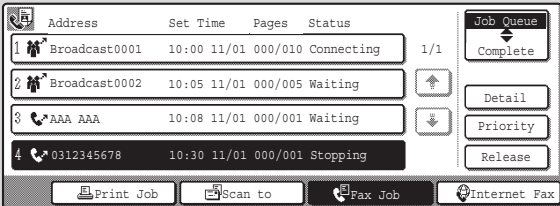

- When transmission of a job is canceled, "Cancel" will appear in the result column of the transaction report.
- **To stop the cancellation and execute the job...**  
 While "Stopping" appears, the cancellation can be stopped and the job can be transmitted.
  - (1) Touch the key of the "Stopping" fax job.
  - (2) Touch the [Release] key.  
 The job status changes to a "Waiting" job.
- Printing of received faxes and forwarding jobs set using "Inbound Routing Settings" (page 104) cannot be canceled.

---

---

# GIVING PRIORITY TO A RESERVED FAX JOB

When multiple fax jobs are waiting to be transmitted, the jobs are normally transmitted in the order they were reserved. If you need to give priority to a job and send it ahead of the other jobs, follow the steps below.

1

JOB STATUS



Press the [JOB STATUS] key.

2

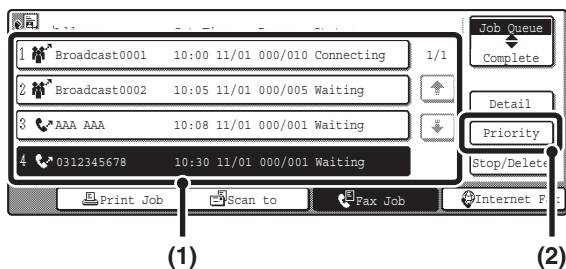

Select the fax job to which you wish to give priority.

(1) Touch the key of the desired job.

(2) Touch the [Priority] key.

The selected job moves up to the position immediately following the job in progress. The job will be executed when the job in progress is completed.

 If the job in progress is a broadcast transmission job or a serial polling job, the priority job will be transmitted between destinations of the broadcast transmission or serial polling job. However, if the priority job is a broadcast transmission job or a serial polling job, it will be executed after the current job is completed.



# 6

# PRINTING A TRANSACTION REPORT / IMAGE SENDING ACTIVITY REPORT

This chapter explains how to print out and check the results of transmissions and receptions.

---

---

## TRANSACTION REPORT

A transaction report is printed when transmission fails or after a broadcast transmission or a confidential reception. The conditions for printing a transaction report can be changed. The conditions can also be changed for only a single transmission.

### Example of a transaction report

The report shows the date, starting time, name of the other party, time required, number of pages, and result.

TRANSACTION REPORT								P. 01/01	
								OCT/03/2005/MON 10:00 AM	
FAX (TX)									
#	DATE	START T.	SENDER	COM. TIME	PAGE	TYPE/NOTE	FILE		
001	OCT/03	09:45AM	xxxxxxxx	0:00:13	1	OK	SG3	2697	



- **System Settings for Fax (Administrator): [Transaction Report Print Select Setting \(page 179\)](#)**

This is used to set the conditions for printing transaction reports.

The factory default settings are printing at  below.

Single Sending:  Print Out All Report/ Print Out Error Report Only/ No Printed Report

Broadcasting:  Print Out All Report/ Print Out Error Report Only/ No Printed Report

Receiving:  Print Out All Report/ Print Out Error Report Only/ No Printed Report

Confidential reception:  Not Print Out Notice Page/ Print Out Notice Page

- **System Settings for Fax (Administrator): [Original Print on Transaction Report \(page 179\)](#)**

This is used to have part of the transmitted original printed on the transaction report.

# CHANGING THE TRANSACTION REPORT PRINT CONDITION FOR A SINGLE TRANSMISSION

When performing a transmission, follow the steps below to select the condition for printing a transaction report. When the transmission is finished, your setting will be cleared.

1

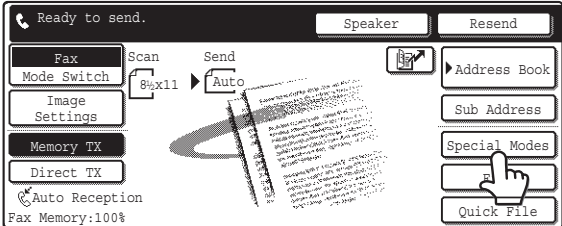

**Touch the [Special Modes] key.**

2

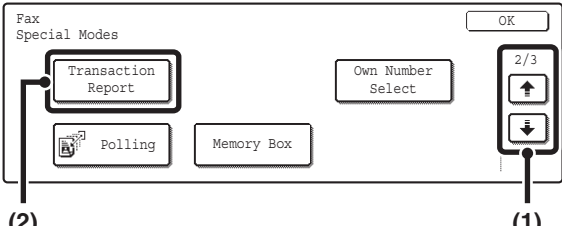

**Display the transaction report print settings screen.**

(1) Touch the keys to switch through the screens.

(2) Touch the [Transaction Report] key.

3

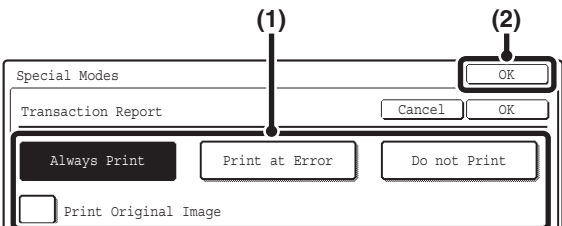

**Select the transaction report print condition.**

(1) Touch the key of the desired print condition.

(2) Touch the [OK] key.



- The print conditions for a transaction report are as follows:
  - "Always Print": A transaction report is printed no matter whether the transmission succeeds or fails.
  - "Print at Error": A transaction report is printed when transmission fails.
  - "Do not Print": Do not print a transaction report.
- When the [Print Original Image] checkbox is selected () , part of the transmitted original is included on the transaction report. However, the original image is not printed when dialing using the speaker, a direct transmission or polling operation is performed.
- To return to the screen of step 2, touch the [OK] key next to the [Cancel] key.



For a broadcast transmission, the print condition applies to each destination.

# INFORMATION APPEARING IN THE RESULT COLUMN

Error types and other information are printed in the result column of the report. Check the transaction result in the result column and take appropriate action if the result is an error.

## Examples of messages that are printed in the result column

Message	Explanation
OK	The transaction was completed normally.
G3	Communication took place in G3 mode.
ECM	Communication took place in G3 ECM mode.
SG3	Communication took place in Super G3 mode.
FW.	The received data was forwarded.
NO RESPONSE	No response from the receiving party.
BUSY	Transmission was not possible because the other party was already using the line.
CANCEL	The transmission was cancelled while in progress.
MEMORY OVER	The memory became full during quick on-line transmission.
MEM.FULL	The memory became full during reception.
LENGTH OVER	The transmitted fax was over 1.5 m (59") long and therefore could not be received.
ORIGINAL ERROR	Direct transmission or manual transmission was not successful because a misfeed occurred.
PASS# NG	The connection was broken because the polling passcode was not correct.
NO RX POLL	The machine that was polled does not have a polling function.
RX POLL FAIL	The other machine refused the polling operation, or your machine broke the connection when polled because no data was in memory.
NO F-CODE POLL	The other machine refused an F-code polling operation, or your machine broke the connection when polled because no data was in its F-code memory polling box.
RX POLL# NG	The connection was broken because the sub-address for F-code polling memory was not valid.
F POLL PASS# NG	The connection was broken because the passcode for F-code polling memory was not valid.
BOX NO. NG	Your machine broke the connection because the specified sub-address for an F-code memory box does not exist.
F PASS# NG	Your machine broke the connection because the other machine sent an incorrect passcode for F-code communication.
RX NO F-CODE POLL	F-code polling was attempted, however, the other machine did not have an F-code polling memory box.
NO F FUNC	F-code communication was attempted, however, the other machine does not support F-code communication.
NO F-CODE	F-code communication was refused by the other machine because of an incorrect sub-address or other reason.
M. BOX: [xxxxxx] *****	Data was received to a confidential or relay broadcast memory box, or data was sent from a memory polling box. The name of the memory box appears in [xxxxxx], and the type of F-code operation (relay request reception, polling memory transmission, or confidential reception) appears in *****.
NG xx (xxxx) (1) (2)	The communication handshake signals or image signals were distorted due to line conditions or other reasons, and communication was not successful. (1) First two digits of communication error number: Error code from 00 to 99. (2) Last four digits of communication error number: Code for use by service technicians.
REJECTED	A fax was sent from a party from which reception is blocked.

# IMAGE SENDING ACTIVITY REPORT

You can print a log of recent image sending activity (date, name of other party, result, etc.). The result column shows messages such as error types and other information. The Image Sending Activity Report shows your most recent 199 transactions.

You can have the machine print the Image Sending Activity Report each time the number of transactions reaches 200, or at a specified time (once a day only).

## Example of the Image Sending Activity Report

The report shows the date, starting time, name of the other party, time required, number of pages, and result.

ACTIVITY REPORT (SEND)								P. 01/01
								OCT/03/2005/MON 10:00 AM
FAX								
#	DATE	START T.	RECEIVER	COM. TIME	PAGE	TYPE/NOTE	FILE	
001	OCT/03	08:55AM	xxxxxxxx				0032	
002		08:56AM	xxxxxxxx	0:00:13	1	OK	SG3 0033	
003		09:01AM	xxxxxxxx	0:00:13	1	OK	SG3 0034	
TOTAL				0:00:26	2			
GRAND TOTAL				0:02:15	9			



- The contents of the Image Sending Activity Report are erased when the report is printed, and thus it cannot be reprinted.
- The Image Sending Activity Report can also be printed manually. For more information, see "[List Print \(Administrator\)](#)" (page 186).



### System Settings for Fax (Administrator): [Activity Report Print Select Setting \(page 179\)](#)

This is used to set the condition for printing activity reports. The factory default setting is not printed.

The Image Sending Activity Report can be set to print each time the number of transactions exceeds 199, or at a specified time (once a day only).

# INFORMATION APPEARING IN THE RESULT COLUMN

Error types and other information are printed in the result column of the report. Check the transaction result in the result column and take appropriate action if the result is an error.

## Examples of messages that are printed in the result column

Message	Explanation
OK	The transaction was completed normally.
G3	Communication took place in G3 mode.
ECM	Communication took place in G3 ECM mode.
SG3	Communication took place in Super G3 mode.
FW.	The received data was forwarded.
NO RESPONSE	No response from the receiving party.
BUSY	Transmission was not possible because the other party was already using the line.
CANCEL	The transmission was cancelled while in progress.
MEMORY OVER	The memory became full during quick on-line transmission.
MEM.FULL	The memory became full during reception.
LENGTH OVER	The transmitted fax was over 1.5 m (59") long and therefore could not be received.
ORIGINAL ERROR	Direct transmission or manual transmission was not successful because a misfeed occurred.
PASS# NG	The connection was broken because the polling passcode was not correct.
NO RX POLL	The machine that was polled does not have a polling function.
RX POLL FAIL	The other machine refused the polling operation, or your machine broke the connection when polled because no data was in memory.
NO F-CODE POLL	The other machine refused an F-code polling operation, or your machine broke the connection when polled because no data was in its F-code memory polling box.
RX POLL# NG	The connection was broken because the sub-address for F-code polling memory was not valid.
F POLL PASS# NG	The connection was broken because the passcode for F-code polling memory was not valid.
BOX NO. NG	Your machine broke the connection because the specified sub-address for an F-code memory box does not exist.
F PASS# NG	Your machine broke the connection because the other machine sent an incorrect passcode for F-code communication.
RX NO F-CODE POLL	F-code polling was attempted, however, the other machine did not have an F-code polling memory box.
NO F FUNC	F-code communication was attempted, however, the other machine does not support F-code communication.
NO F-CODE	F-code communication was refused by the other machine because of an incorrect sub-address or other reason.
M. BOX: [xxxxxx] *****	Data was received to a confidential or relay broadcast memory box, or data was sent from a memory polling box. The name of the memory box appears in [xxxxxx], and the type of F-code operation (relay request reception, polling memory transmission, or confidential reception) appears in *****.
NG xx (xxxx)      (1) (2)	The communication handshake signals or image signals were distorted due to line conditions or other reasons, and communication was not successful. (1) First two digits of communication error number: Error code from 00 to 99. (2) Last four digits of communication error number: Code for use by service technicians.
REJECTED	A fax was sent from a party from which reception is blocked.

# 7

## CONVENIENT FUNCTIONS

This chapter explains convenient functions for sending and receiving faxes.

---

---

### SENDING THE SAME FAX TO MULTIPLE DESTINATIONS (Broadcast transmission)

This function is convenient when you need to send the same fax to multiple destinations, such as sending a report to branch offices in different regions. You can transmit to as many as 500 destinations in one broadcast operation.

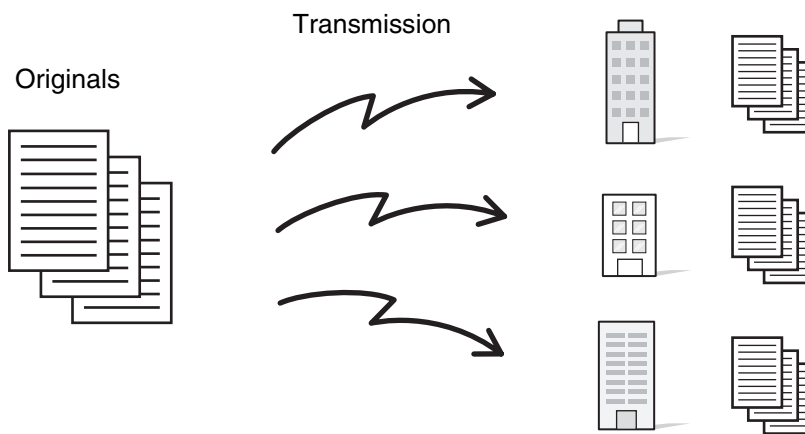

It is convenient to store destinations to which you frequently send faxes by broadcast transmission in group keys. Group dialing allows you to call up multiple fax numbers stored in a one-touch key by simply pressing the one-touch key. To store destinations in a group key, see "[Storing a Group Key](#)" (page 140) in the system settings for fax.

When a group key is used to dial, the number of fax numbers that are dialed is the number of destinations that are stored in the group key. When a group key that has ten destinations is used, ten fax numbers are dialed.

1

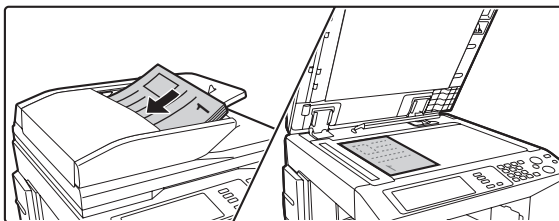

#### Place the original.

Place the original face up in the document feeder tray, or face down on the document glass.

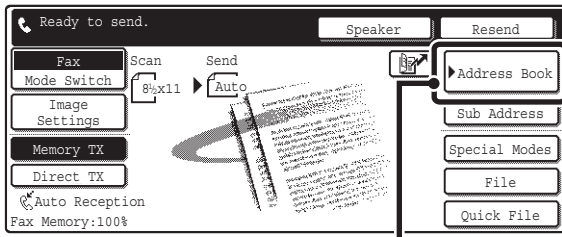

(1)

## Enter the first destination fax number.

- (1) Touch the [Address Book] key.
- (2) Touch the one-touch key of the desired destination.

It is convenient to use a group key to enter the destinations.

- (3) Touch the [To] key.
- (4) Repeat steps (2) and (3) to enter the remaining destinations.

[CALLING UP A FAX NUMBER FROM THE ADDRESS BOOK](#) (page 36)

If the fax number of the transmitting machine is not stored in the Address Book, enter the fax number with the numeric keys.

[ENTERING A FAX NUMBER WITH THE NUMERIC KEYS](#) (page 35)

2

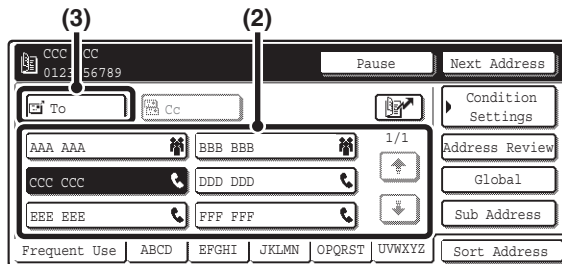

Touch the [Next Address] key before entering the next destination.

The [Next Address] key can be omitted before and after a destination entered with a one-touch key.

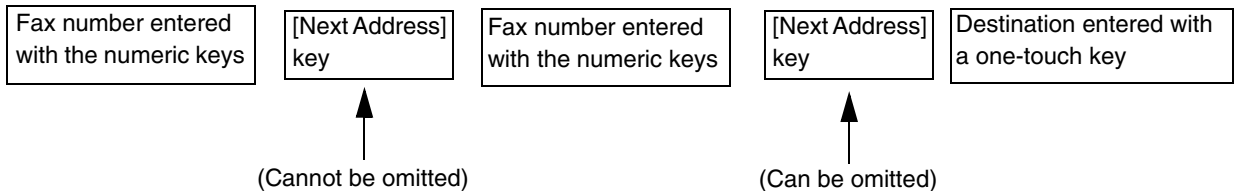

**System Settings for Fax (Administrator):** [Must Input Next Address Key at Broadcast Setting](#) (page 176)

This setting is used to prohibit omission of the [Next Address] key when entering destinations for broadcast transmissions.

3

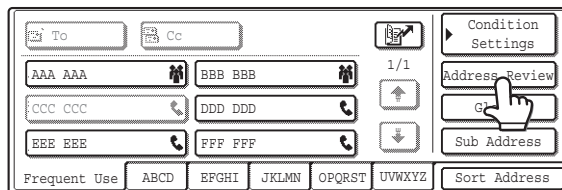

## Touch the [Address Review] key.

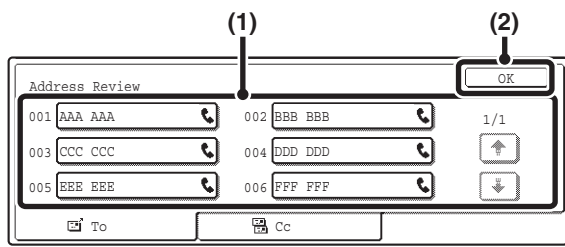

## Check the destinations.

(1) Check the destinations.

(2) Touch the [OK] key.



### To cancel an entered destination...

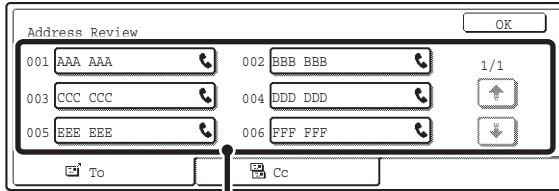

(1) Touch the key of the destination that you wish to cancel.

(2) Touch the [Yes] key.

If you do not wish to cancel the destination, touch the [No] key.

(3) Touch the [OK] key.

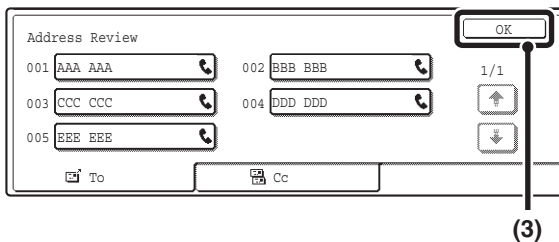
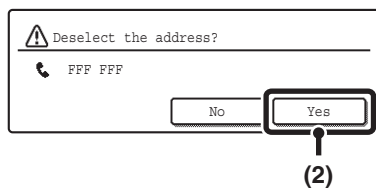

## Press the [BLACK & WHITE START] key (○●).

Scanning begins.

- If you inserted the original pages in the document feeder tray, all pages are scanned. A beep will sound to indicate that scanning is finished.
- If you are scanning the original on the document glass, scan each page one page at a time. When scanning finishes, place the next original and press the [BLACK & WHITE START] key (○●). Repeat until all pages have been scanned and then press the [Read-End] key. A beep will sound to indicate that scanning is finished.



### To cancel scanning...

Press the [STOP] key (⊞).



- A broadcast transmission can be used in combination with the timer transmission function to transmit at night or any other desired time. A broadcast transmission can also be used in combination with other convenient functions.
- The broadcast transmission can include Scan to E-mail and Internet fax destinations. In this case, the image sent to the Scan to E-mail and Internet fax destinations will be black and white.



# Resending to unsuccessful destinations

The results of a completed broadcast transmission can be checked in the job status screen. If transmission to any of the destinations failed, resend the image to those destinations.

1

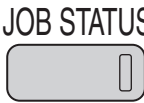

**JOB STATUS**

**Press the [JOB STATUS] key.**

---

2

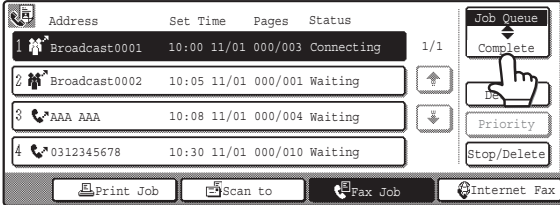

**Touch the [Complete] key.**

If the job status screen of fax mode does not appear, touch the [Fax Job] key.

---

3

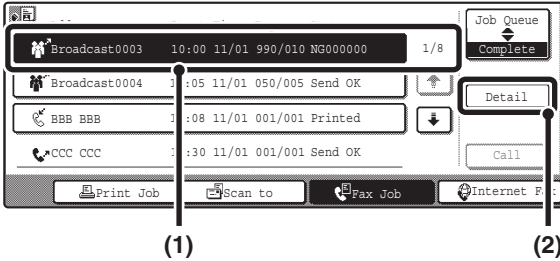

**Display details on the broadcast transmission.**

(1) Touch the key of the completed broadcast transmission.

(2) Touch the [Detail] key.

---

4

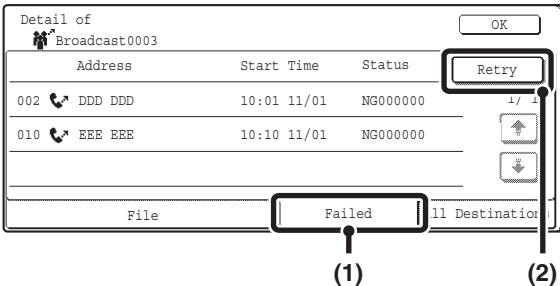

**Resend to unsuccessful destinations.**

(1) Touch the [Failed] tab.

(2) Touch the [Retry] key.

---

4



- Operation after the [Retry] key is touched varies depending on whether or not the document filing function is used.
  - Not using document filing**
  - You will return to the base screen with the unsuccessful destinations entered. Place the original and perform the broadcast transmission operation.
  - Using document filing**
  - The document filing resend screen will appear with the unsuccessful destinations entered. Perform the document filing resend procedure. (There is no need to rescan the original.)
  - If the job was stored in a confidential folder or was stored as confidential file, a password entry screen will appear after you touch the [Retry] key. Enter the password.
  - For more information, see the Document Filing Guide.
- If the [All Destinations] key is touched in (1), all of the destinations will be displayed. The [Retry] key that appears in the screen can be touched to resend to all the destinations.

65

# SENDING A FAX AT A SPECIFIED TIME (Timer)

When this function is used, transmission takes place automatically at a specified time.

The timer transmission function makes it easy to perform reserved transmissions, broadcast transmissions and other transmissions at night or other times when phone rates are low.

A timer setting can also be specified for polling reception to receive a fax when you are not present.

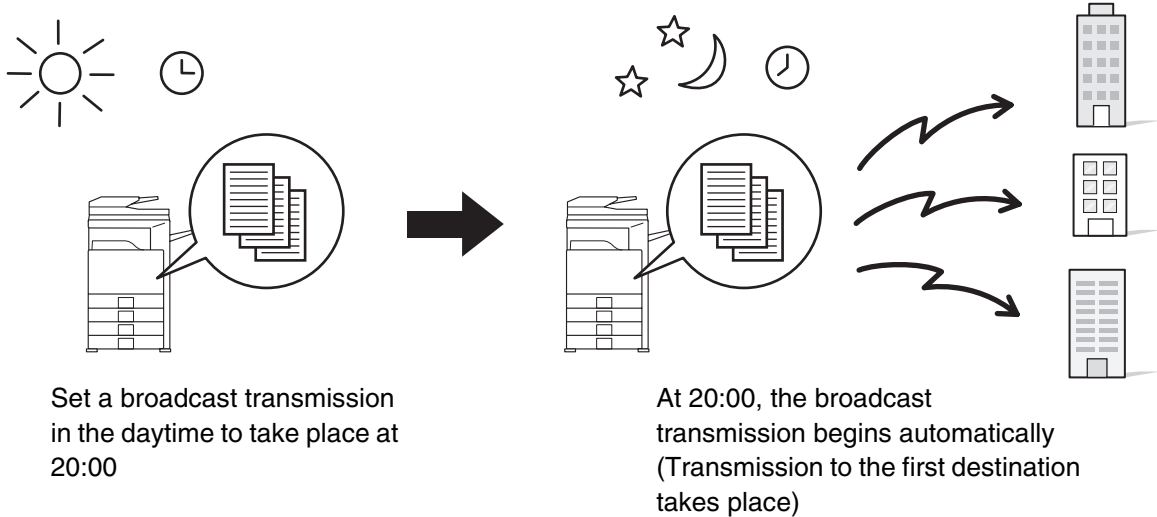

- When timer transmission is set, always keep the main power switch in the "On" position. Transmission will not take place if the main power is off at the specified time.
- When performing a timer transmission, you must scan the original into memory when you set up the transmission. It is not possible to leave the document in the auto document feeder or on the document glass and have it scanned at the reserved time of transmission.
- When the transmission is finished, the transmission settings (resolution, destinations, etc.) will be erased. However, the selected settings and transmitted fax image are stored if the document filing function is used.

📖 Document Filing Guide

1

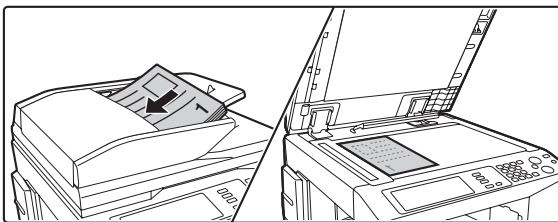

## Place the original.

Place the original face up in the document feeder tray, or face down on the document glass.

2

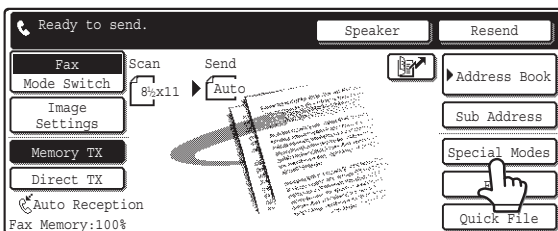

## Touch the [Special Modes] key.

3

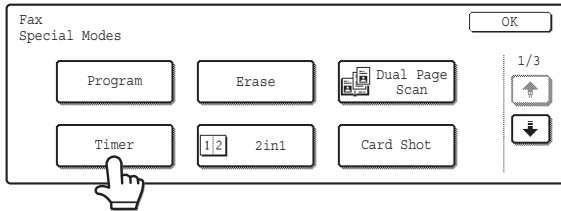

Touch the [Timer] key.

4

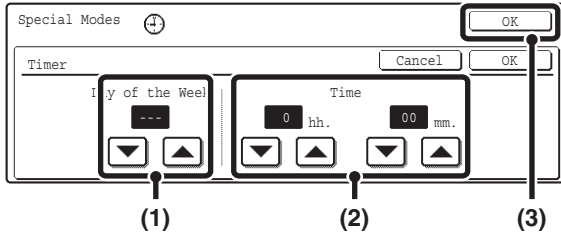

Set the time with the keys.

**(1) Specify the day.**

If you do not wish to specify a day, select [---]. In this case, transmission will begin when the time specified in (2) arrives.

**(2) Specify the time (hour, minute)**

Select the time in 24-hour format.

**(3) Touch the [OK] key.**



- When this screen is opened, the setting will show the current time. If the time is not correct, press the [CLEAR ALL] key () to cancel the operation. Correct the time in the system settings and then perform the timer transmission procedure.
- Touch the [OK] key next to the [Cancel] key to complete the settings and you will return to step 2.

5

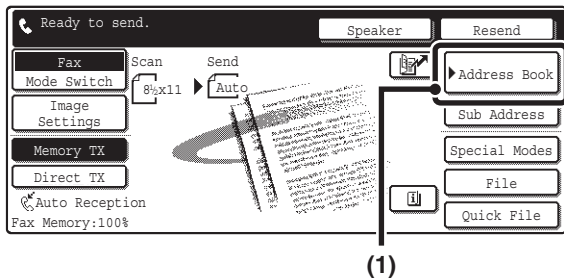

Enter the destination fax number.

**(1) Touch the [Address Book] key.**

**(2) Touch the one-touch key of the desired destination.**

**(3) Touch the [To] key.**

[CALLING UP A FAX NUMBER FROM THE ADDRESS BOOK](#) (page 36)

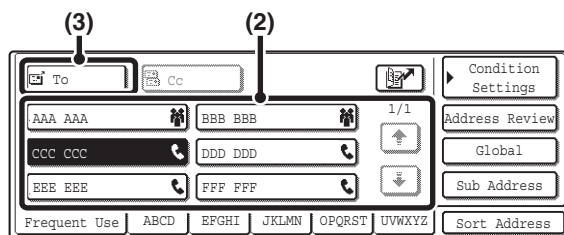

If the fax number of the transmitting machine is not stored in the Address Book, enter the fax number with the numeric keys.

[ENTERING A FAX NUMBER WITH THE NUMERIC KEYS](#) (page 35)



You can touch the key to display a list of the selected special mode settings or two-sided scanning. To return to the previous screen after checking the settings, touch the [OK] key.



## Press the [BLACK & WHITE START] key (○●).

Scanning begins.

- If you inserted the original pages in the document feeder tray, all pages are scanned.  
A beep will sound to indicate that scanning is finished.
- If you are scanning the original on the document glass, scan each page one page at a time.

When scanning finishes, place the next original and press the [BLACK & WHITE START] key (○●). Repeat until all pages have been scanned and then press the [Read-End] key.

A beep will sound to indicate that scanning is finished.

- The time can be specified up to a week in advance.
- Up to 94 timer transmissions can be stored at once.
- Only one timer polling operation can be stored at once. If you wish to poll from multiple machines, store a serial polling timer operation.
- If another transmission is in progress when the specified time arrives, the timer operation will begin after that transmission is finished.
- Other operations can be performed after a timer transmission is set up.
- Dialing with the speaker and direct transmission cannot be used in a timer transmission.
- If you give priority to a timer transmission in the job status screen, the timer setting will be canceled and the transmission will begin after the job in progress is finished.  
 [GIVING PRIORITY TO A RESERVED FAX JOB](#) (page 56)



### To cancel timer transmission...

Touch the [Cancel] key in the screen of step 4.

# ERASING PERIPHERAL SHADOWS ON THE IMAGE (Erase)

The erase function is used to erase shadows on images produced when scanning thick originals or books.

## Scanning a thick book

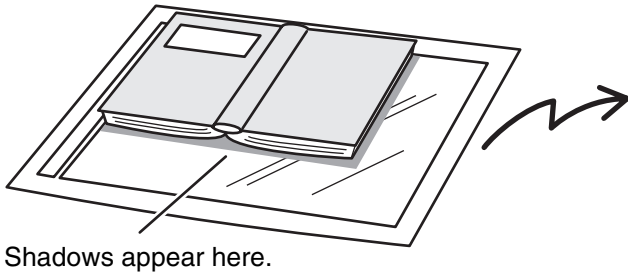

Shadows appear here.

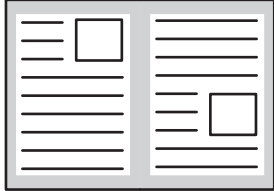
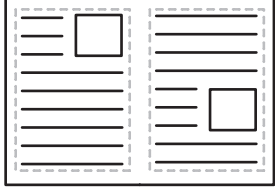
Not using the erase function	Using the erase function
	
Shadows appear in the image.	No shadows appear.

## Erase modes

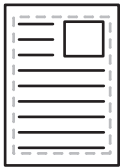

**Edge erase**  
This erases shadows that appear at the edges of the image when thick originals or books are faxed.

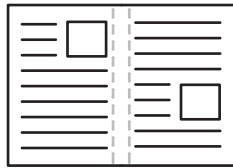

**Center erase**  
This erases shadows at the bindings of books or other bound documents.

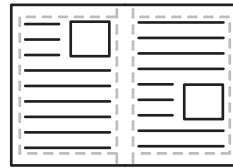

**Edge + Center erase**  
This erases shadows at both the edges and the binding.

1

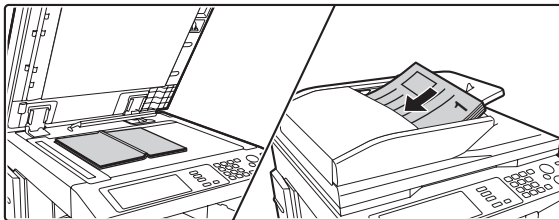

## Place the original.

Place an original that cannot be inserted in the document feeder tray face down on the document glass.  
If the original can be placed in the document feeder tray, place it face up.

2

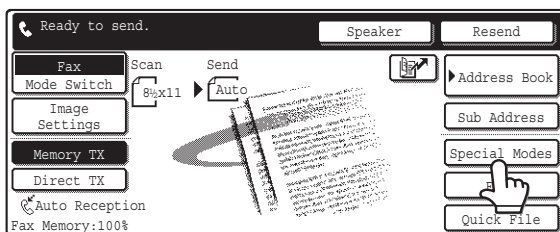

## Touch the [Special Modes] key.

3

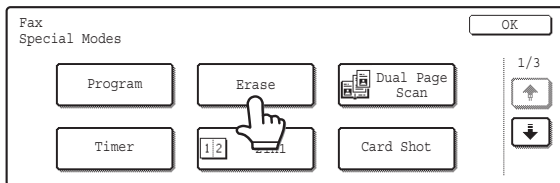

Touch the [Erase] key.

4

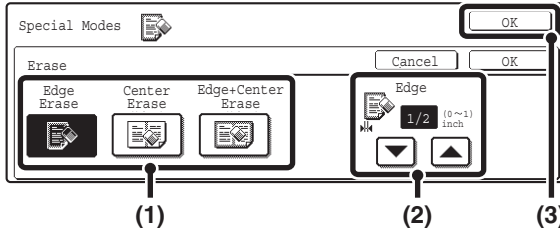

Select the erase settings.

- (1) Touch the desired erase mode.  
Select one of the three erase modes.
- (2) Set the erasure width with .  
0" to 1" (0 mm to 20 mm) can be entered.
- (3) Touch the [OK] key.



Touch the [OK] key next to the [Cancel] key to complete the settings. You will return to step 3.

5

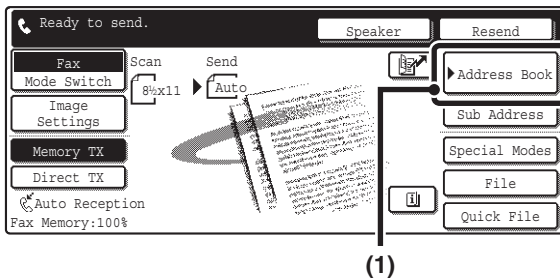

Enter the destination fax number.

- (1) Touch the [Address Book] key.
- (2) Touch the one-touch key of the desired destination.
- (3) Touch the [To] key.

[CALLING UP A FAX NUMBER FROM THE ADDRESS BOOK](#) (page 36)

If the fax number of the transmitting machine is not stored in the Address Book, enter the fax number with the numeric keys.

[ENTERING A FAX NUMBER WITH THE NUMERIC KEYS](#) (page 35)

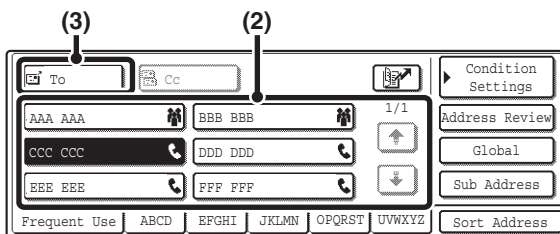

You can touch the key to display a list of the selected special mode settings or two-sided scanning. To return to the previous screen after checking the settings, touch the [OK] key.



## Press the [BLACK & WHITE START] key (○●).

Scanning begins.

- If you inserted the original pages in the document feeder tray, all pages are scanned. A beep will sound to indicate that scanning is finished.
- If you are scanning the original on the document glass, scan each page one page at a time.

When scanning finishes, place the next original and press the [BLACK & WHITE START] key (○●). Repeat until all pages have been scanned and then press the [Read-End] key.

A beep will sound to indicate that scanning is finished.



### To cancel scanning...

Press the [STOP] key (Ⓢ).



- When the erase function is used, erase takes place at the edges of the original image. If you also use a reduction or an enlargement setting, the erase width will change according to the selected ratio. For example, if the erase width setting is 1" (20 mm) and the image is reduced to 50%, the erase width will be 1/2" (10 mm).
- This function cannot be used in combination with the following functions:  
Card shot, Dual Page Scan (edge erase only is possible)



### To cancel an erase setting...

Touch the [Cancel] key in the screen of step 4.

# TRANSMITTING AN ORIGINAL AS TWO SEPARATE PAGES (Dual Page Scan)

The left and right sides of an original can be transmitted as two separate pages. This function is useful when you wish to fax the left and right pages of a book or other bound document as separate pages.

## Faxing the left and right pages of a book

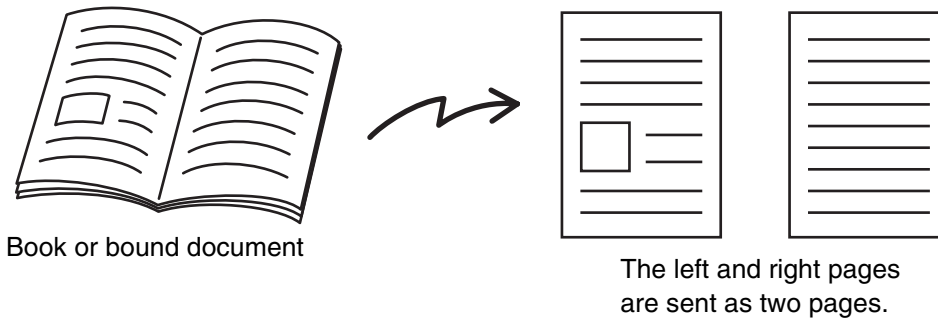

Original scan size	Transmitted image
11" x 17" (A3) x 1 page	8-1/2" x 11" (A4) x 2 pages



- When using dual page scan, the original must be placed on the document glass.
- The send size cannot be changed.

1

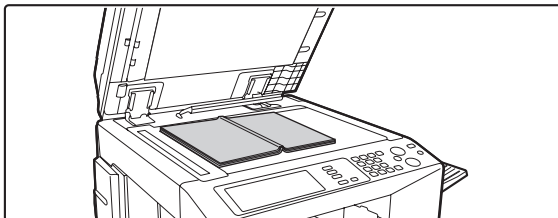

## Place the original face down on the document glass.

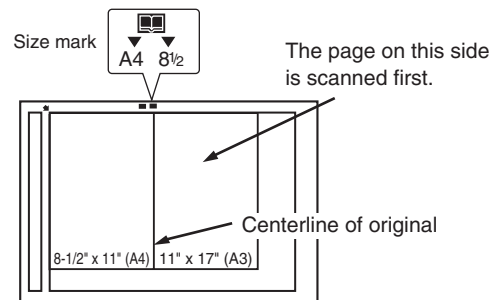

Place the opened original on the document glass so that the first page you wish to transmit is on the right and the center of the original is aligned with the size mark.

2

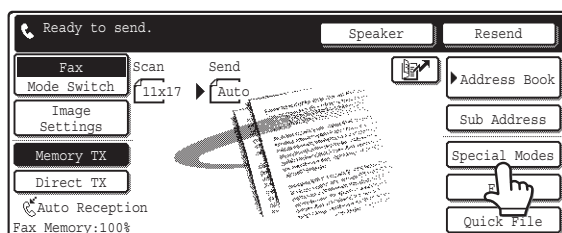

## Touch the [Special Modes] key.



3

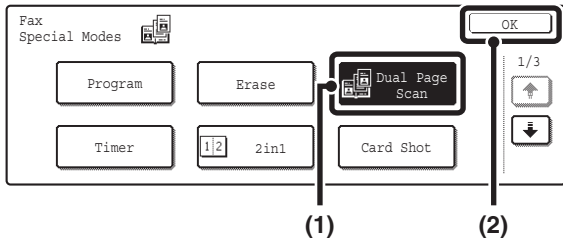

**Select Dual Page Scan.**

- (1) Touch the [Dual Page Scan] key so that it is highlighted.
- (2) Touch the [OK] key.

4

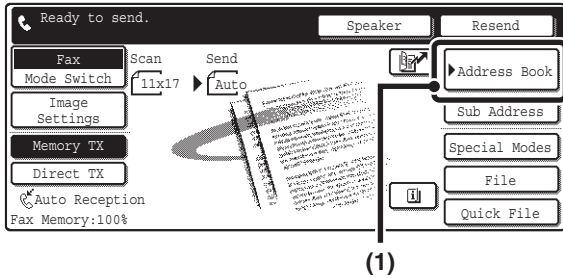

**Enter the destination fax number.**

- (1) Touch the [Address Book] key.
- (2) Touch the one-touch key of the desired destination.
- (3) Touch the [To] key.

☞ [CALLING UP A FAX NUMBER FROM THE ADDRESS BOOK](#) (page 36)

If the fax number of the transmitting machine is not stored in the Address Book, enter the fax number with the numeric keys.

☞ [ENTERING A FAX NUMBER WITH THE NUMERIC KEYS](#) (page 35)

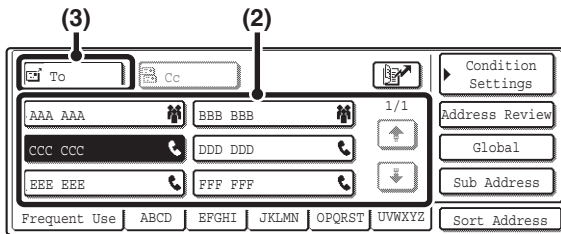

You can touch the  key to display a list of the selected special mode settings or two-sided scanning. To return to the previous screen after checking the settings, touch the [OK] key.

5



**Press the [BLACK & WHITE START] key (○●) to scan the first two pages.**



**To cancel scanning...**  
Press the [STOP] key (Ⓢ).

6

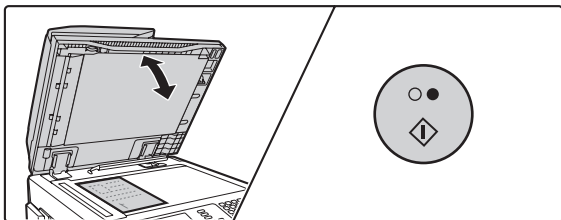

**If you have more pages to scan, change pages and then press the [BLACK & WHITE START] key (○●).**

Repeat until all pages have been scanned.

7

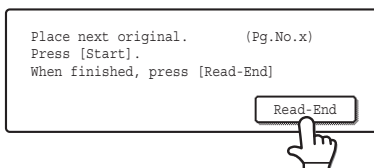

**Touch the [Read-End] key.**



- To erase shadows caused by the binding of a book or other bound document, use the erase function. (Note, however, that "Center Erase" and "Edge + Center Erase" cannot be used.)
- This function cannot be used in combination with the following functions:  
2in1, Card Shot, Job Build Mode, Mixed Size Original



**To cancel Dual Page Scan...**

Touch the [Dual Page Scan] key in the screen of step 3.

---

---

# SENDING TWO PAGES AS A SINGLE PAGE (2in1)

Two original pages can be reduced and sent as a single page. This function is convenient when you have a large number of original pages and wish to reduce the number of pages sent.

Originals (portrait)

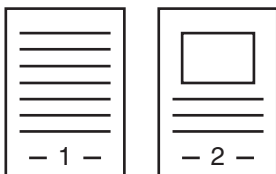

Transmission

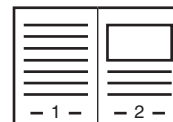

Originals (landscape)



Transmission

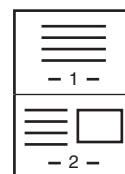

This function cannot be used in direct transmission mode or when the speaker is used to dial.

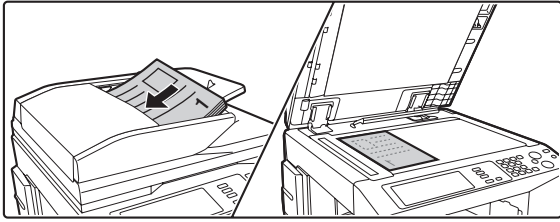



**Place the original.**

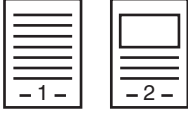
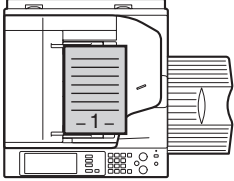
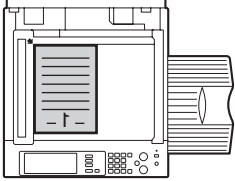

When placing the originals, orient them as shown below.

**1**

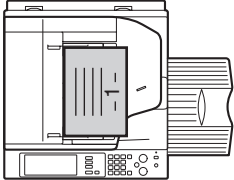
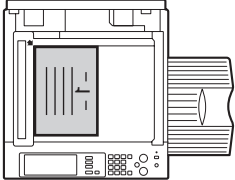
Originals	Document feeder tray (Place the originals face up.)	Document glass (Place each original face down.)
Portrait originals 		
Landscape originals 		

**2**

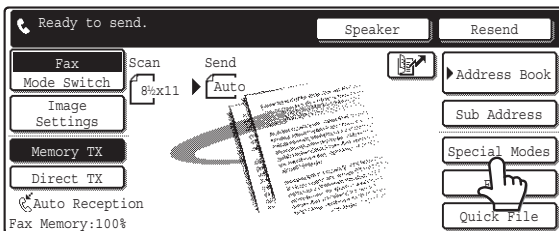

**Touch the [Special Modes] key.**

**3**

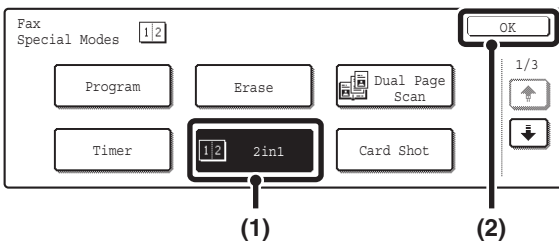

**Select 2in1.**

- (1) Touch the [2in1] key so that it is highlighted.
- (2) Touch the [OK] key.

4

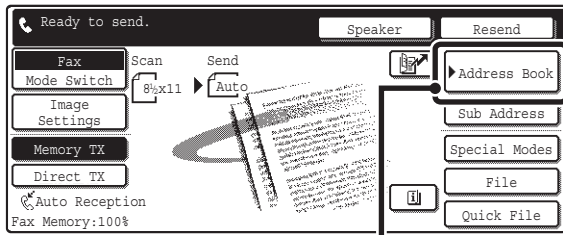

(1)

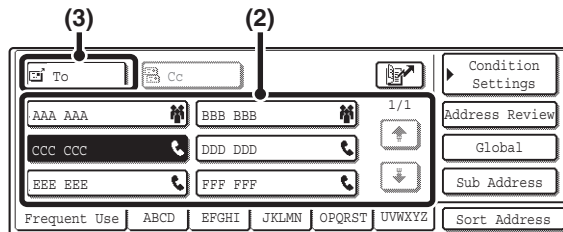

## Enter the destination fax number.

(1) Touch the [Address Book] key.

(2) Touch the one-touch key of the desired destination.

(3) Touch the [To] key.

☞ [CALLING UP A FAX NUMBER FROM THE ADDRESS BOOK](#) (page 36)

If the fax number of the transmitting machine is not stored in the Address Book, enter the fax number with the numeric keys.

☞ [ENTERING A FAX NUMBER WITH THE NUMERIC KEYS](#) (page 35)



You can touch the  key to display a list of the selected special mode settings or two-sided scanning. To return to the previous screen after checking the settings, touch the [OK] key.

5



## Press the [BLACK & WHITE START] key (○●).

Scanning begins.

- If you inserted the original in the document feeder tray, all pages are scanned. A beep will sound to indicate that scanning is finished.
- If you are scanning the original on the document glass, scan each page one page at a time. When scanning finishes, place the next original and press the [BLACK & WHITE START] key (○●). Repeat until all pages have been scanned and then press the [Read-End] key. A beep will sound to indicate that scanning is finished.



### To cancel scanning...

Press the [STOP] key (⊖).



- The 2in1 function cannot be used when the original is other than 8-1/2" x 11" (A4) or 5-1/2" x 8-1/2" (B5 or A5) size.
- This function cannot be used in combination with the following functions:  
Dual Page Scan, Card Shot, Mixed Size Original



### To cancel 2in1...

Touch the [2in1] key in the screen of step 3.

# SENDING BOTH SIDES OF A CARD AS A SINGLE PAGE (Card Shot)

You can scan the front and reverse sides of a card and send them as a single page.

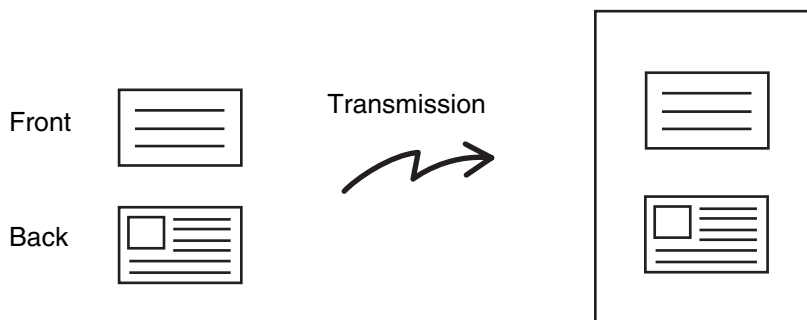

- When using card shot, the original must be scanned on the document glass.
- This function cannot be used in direct transmission mode.

1

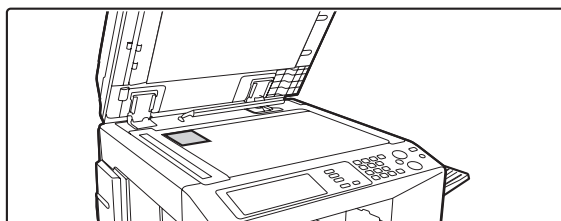

Place the original (card) face down on the document glass.

2

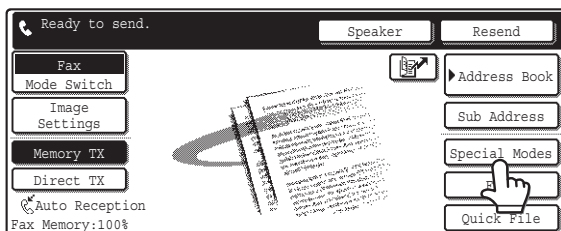

Touch the [Special Modes] key.

3

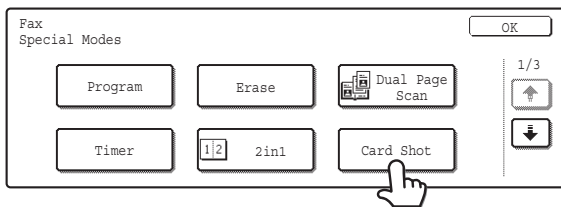

Touch the [Card Shot] key.

4

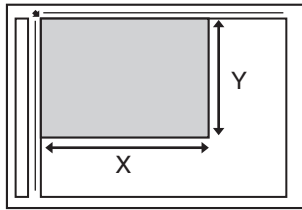
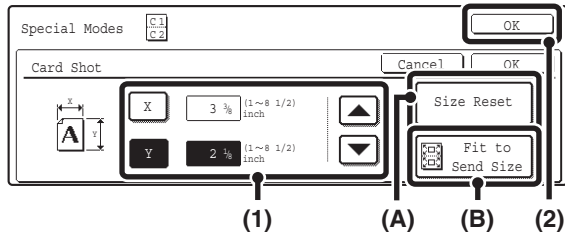

## Enter the original size with the key.

### (1) Enter the original size.

- With the [X] key highlighted, enter the X (horizontal) length of the original with the  $\blacktriangledown$   $\blacktriangle$  keys.
- Touch the [Y] key and enter the Y (vertical) length of the original with the  $\blacktriangledown$   $\blacktriangle$  keys.
  - (A) To return the original size to the default size, touch the [Size Reset] key.
  - (B) To automatically enlarge or reduce the image size to the send size, touch the [Fit to Send Size] key. Do not touch this key if you wish to scan the original at the original size that you entered.

### (2) Touch the [OK] key.



- The send size is automatically selected based on the original size you entered. The send size can also be changed manually.
- To complete the setting and return to the screen of step 3, touch the [OK] key next to the [Cancel] key.

5

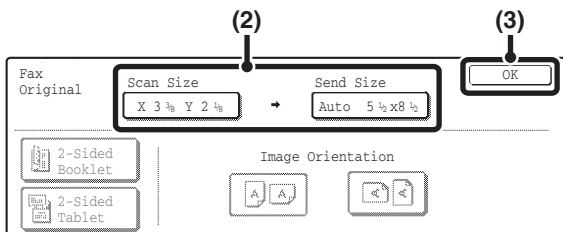
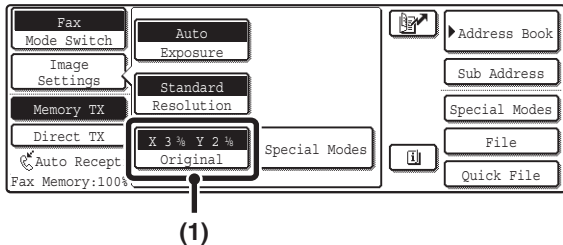

## Changing the original scan size and send size.

If you do not need to change the scan size or send size, go to step 6.

### (1) Touch the [Image Settings] key and then touch the [Original] key.

### (2) Change the scan and send size.

- Touch the [Scan Size] key to return to step 4. Specify the size.
- Touch the [Send Size] key to display the send size selection screen. Touch the desired send size key and touch the [OK] key.

### (3) Touch the [OK] key.

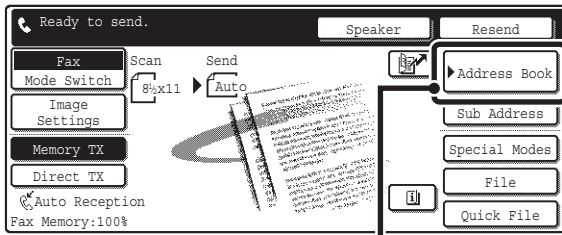

(1)

## Enter the destination fax number.

(1) Touch the [Address Book] key.

(2) Touch the one-touch key of the desired destination.

(3) Touch the [To] key.

☞ [CALLING UP A FAX NUMBER FROM THE ADDRESS BOOK](#) (page 36)

If the fax number of the transmitting machine is not stored in the Address Book, enter the fax number with the numeric keys.

☞ [ENTERING A FAX NUMBER WITH THE NUMERIC KEYS](#) (page 35)

6

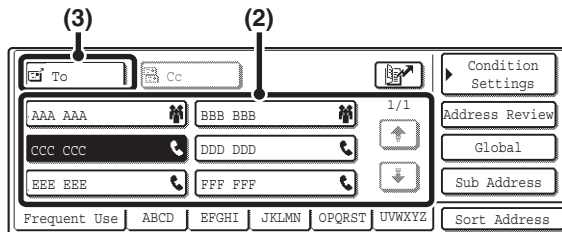

You can touch the  key to display a list of the selected special mode settings or two-sided scanning. To return to the previous screen after checking the settings, touch the [OK] key.

7



Press the [BLACK & WHITE START] key (○●) to scan the front of the card.

8

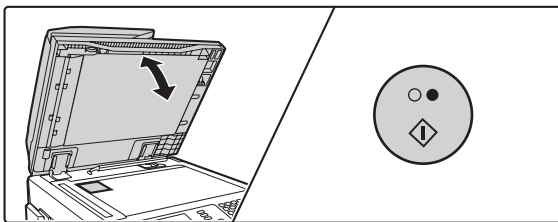

Turn the card over so that the back is face down, and press the [BLACK & WHITE START] key (○●) to scan the back of the card.

9

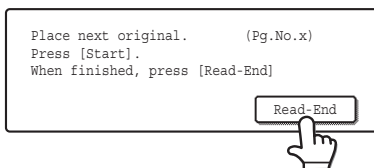

Touch the [Read-End] key.



- The ratio cannot be specified and the Rotation Sending Setting cannot be selected.
- This function cannot be used in combination with the following functions:  
Erase, Dual Page Scan, 2in1, Job Build Mode, Mixed Size Original, Slow Scan Mode



### To cancel card shot...

Touch the [Cancel] key in the screen of step 4.



# STORING FAX OPERATIONS (Programs)

A program is a group of transmission settings stored together. When transmission settings are stored in a program, the settings can be called up and used for a fax job by means of a simple operation.

For example, suppose that the same 8-1/2" x 11" (A4) size documents are distributed to branch offices in various regions once a month.

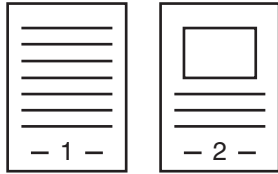

- (1) The same documents are faxed to each branch office
- (2) To save paper, two document pages are faxed as a single page
- (3) Smudges on the edges of the documents are erased before transmission

8-1/2" x 11" (A4) size documents to be distributed

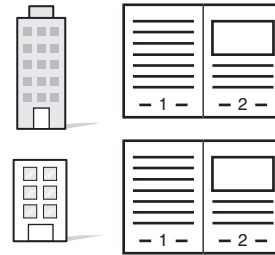

Fax received by recipients.



When a job program is not stored	When a job program is stored
<p>Enter the fax numbers of the branch offices</p> <p style="text-align: center;">↓</p> <p>Select the 2in1 function.</p> <p style="text-align: center;">↓</p> <p>Select erase settings</p> <p style="text-align: center;">↓</p>  <p>Press the [BLACK &amp; WHITE START] key. The originals are scanned and transmitted.</p>	<p>Call up the stored program.</p> <p style="text-align: center;">↓</p>  <p>Press the [BLACK &amp; WHITE START] key. The originals are scanned and transmitted.</p>
<p>Considerable time is required to send the documents each month because the above settings must be selected. In addition, mistakes may occasionally be made when selecting the settings, so incorrect transmissions may occur.</p>	<p>When a program is stored, settings are selected with ease by simply pressing the stored key. In addition, transmission takes place based on the stored settings so there are no chances for mistakes.</p>



- Programs are stored, edited, and deleted using "Address Control" in the System Settings for fax.
  - ➔ [Storing a Program](#) (page 144)
- The following settings can be stored in program.
  - Destinations: One-touch keys, group keys, search numbers
  - Original settings: Resolution and exposure settings
  - Special modes: Polling reception, Erase, Dual Page Scan, 2in1
  - F-code communication: A destination that includes an F-code can be stored to perform an F-code operation.
- The following settings cannot be stored in programs. These settings and functions can be selected before transmission.
  - Original settings: Send size setting
  - Special modes: Timer transmission, Card Shot, Job Build mode, Mixed Original, Slow Scan mode, Own Number Select, Polling Memory, Transaction Report, File, Quick File
- Up to 48 programs can be stored and can be used repeatedly.
- Up to 500 destinations can be stored in each program.

## Using a program to send a fax (Program)

1

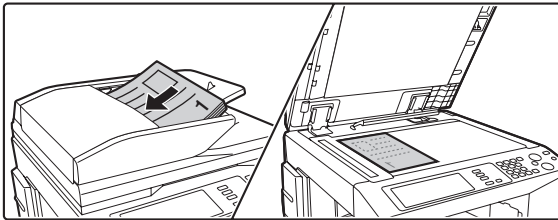

### Place the original.

Use the automatic document feeder or the document glass depending on the functions stored in the program.

2

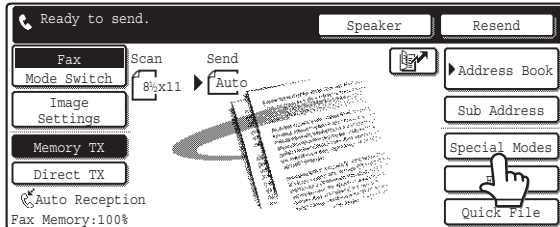

### Touch the [Special Modes] key.

3

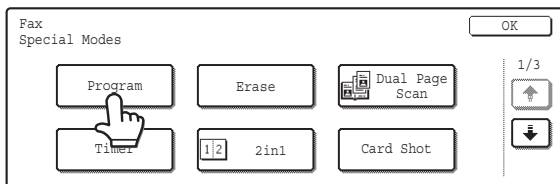

### Touch the [Program] key.

4

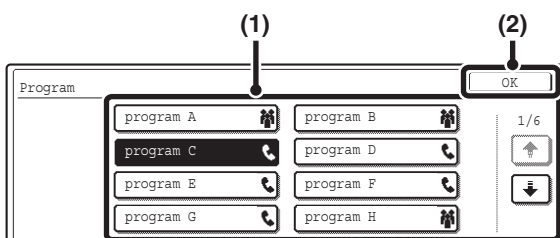

### Select the program that you wish to use.

- (1) Touch the desired program key.
- (2) Touch the [OK] key.

5

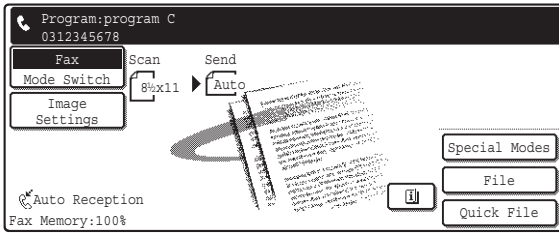

## Select additional settings.

Select any settings or functions that you wish to use that cannot be stored in a program.



Functions stored in the program cannot be canceled here.

6



## Press the [BLACK & WHITE START] key (○●).

Scanning begins.

- If you inserted the original in the document feeder tray, all pages are scanned. A beep will sound to indicate that scanning is finished.
- If you are scanning the original on the document glass, scan each page one page at a time. When scanning finishes, place the next original and press the [BLACK & WHITE START] key (○●). Repeat until all pages have been scanned and then press the [Read-End] key. A beep will sound to indicate that scanning is finished.

# ADDING YOUR SENDER INFORMATION TO FAXES (Own number sending)

You can have your sender information (date, time, sender name, sender fax number, number of pages) automatically added to the top center of each fax page you transmit.

## Example of the sender information printed

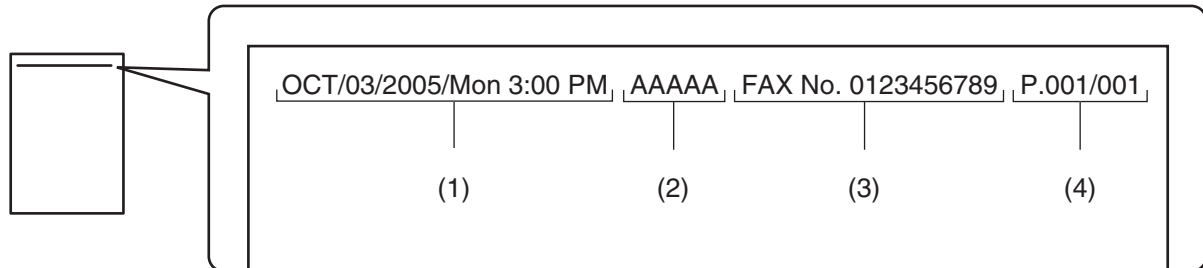

- (1) Date, time: The date and time of transmission.
- (2) Sender name: The sender name programmed in the machine.
- (3) Sender fax number: The sender fax number programmed in the machine.
- (4) Page numbers: Page number / total pages (The total page number is only printed when the fax is sent by memory transmission.)



### Information programmed in Own Number Sending

Date, time: Set or check the date and time in "[CHECKING THE DATE AND TIME](#)" (page 126) in the system settings.

Sender name, sender fax number: Program the sender name and fax number in "[Fax Own Name and Number Set \(administrator\)](#)" (page 178) in the system settings (administrator).

Page numbers: Select whether or not to include page numbers in "[Printing Page Number at Receiver](#)" (page 180) in the system settings for fax (administrator). Page numbers appear in the format "page number / total pages". Only the page number is printed when manual transmission or quick online transmission is used.



### System Settings for Fax (Administrator): [Date/Own Number Print Position Setting](#) (page 180)

This is used to set the position where the sender information is printed. The sender information can be printed outside the scanned original image or inside the scanned original image.

Outside scanned image (factory default setting)	Inside scanned image
<p>Sender information</p> <p>Original</p> <p>The transmitted image length will be: length of sender information + length of original image. When the fax is printed by the receiving machine, it may be reduced or divided onto two pages.</p>	<p>Sender information</p> <p>Original</p> <p>The sender information is printed inside the original image, and thus the transmitted image length is the length of the original. Note that the sender information will overlap part of the original image (that part of the original image will not appear).</p>

# TEMPORARILY CHANGING THE SENDER INFORMATION (Own Number Select)

You can select the sender information printed on a transmitted fax from a list of stored senders. (The selection only applies to the current transmission; after the transmission is completed, the selection is cleared.)

**1**

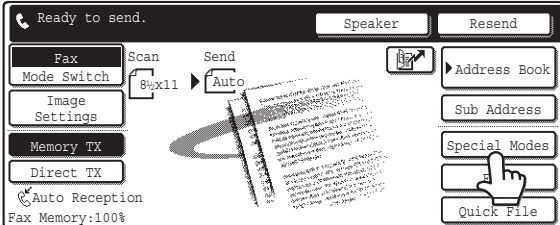

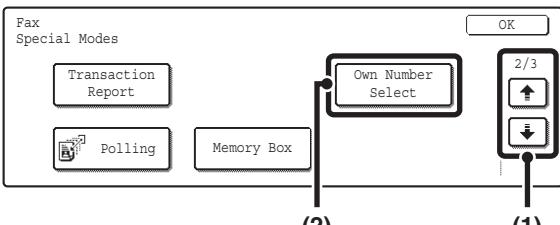

Touch the [Special Modes] key.

**2**



Touch the [Own Number Select] key.

(1) Touch the   keys to switch through the screens.  
(2) Touch the [Own Number Select] key.

**3**

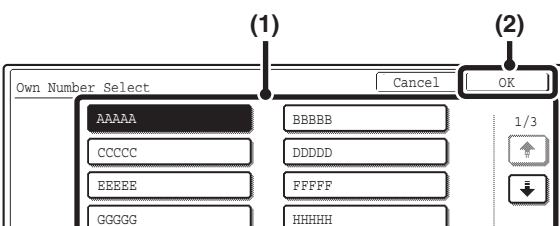

Select the sender information.

(1) Touch the desired sender information key.  
(2) Touch the [OK] key.

**4**

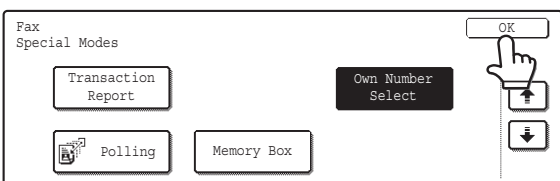

Touch the [OK] key.

**System Settings for Fax (Administrator): [Registration of Own Name Select](#) (page 181)**  
This is used to store sender information for Own Number Select.

# TRANSMITTING ORIGINALS OF DIFFERENT SIZES (Mixed Size Original)

This feature lets you scan originals of different sizes at the same time; for example, 8-1/2" x 14" (B4) size originals mixed together with 11" x 17" (A3) size originals. When scanning the originals, the machine automatically detects the size of each original.



This feature can only be used with the following combinations of original sizes:

11" x 17" and 8-1/2" x 14", 11" x 17" and 8-1/2" x 13", 11" x 17" and 5-1/2" x 8-1/2"

(A3 and B4, A3 and B5, A4 and B4, A4 and B5, A4R and B5, B4 and A4R, B4 and A5, B5 and A5)

1

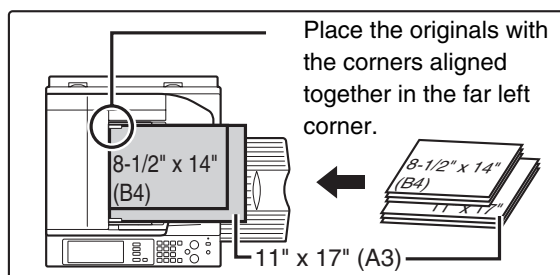

## Insert the originals face up in the document feeder tray.

Insert the originals with the corners aligned together in the far left corner of the document feeder tray.

The following combinations of sizes of originals can be placed together in the document feeder tray: 11" x 17" and 8-1/2" x 14", 11" x 17" and 8-1/2" x 13", 11" x 17" and 5-1/2" x 8-1/2" (A3 and B4, A3 and B5, A4 and B4, A4 and B5, A4R and B5, B4 and A4R, B4 and A5, B5 and A5)

2

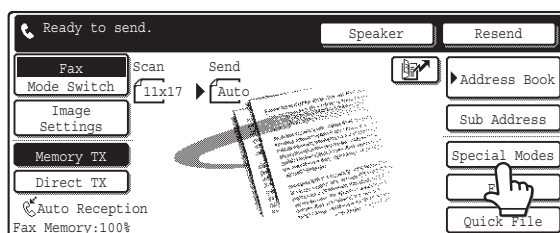

## Touch the [Special Modes] key.

3

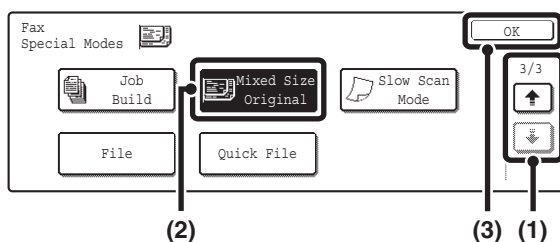

## Select the mixed size original setting.

- (1) Touch the keys to switch through the screens.
- (2) Touch the [Mixed Size Original] key so that it is highlighted.
- (3) Touch the [OK] key.

4

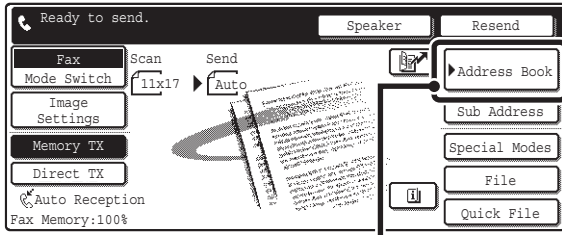

(1)

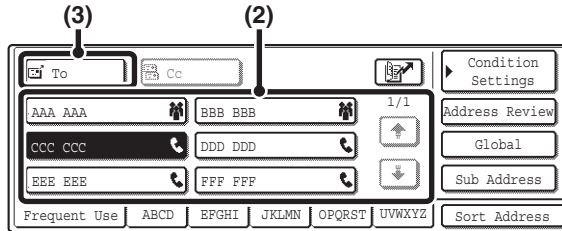

(3)

(2)

### Enter the destination fax number.

- (1) Touch the [Address Book] key.
- (2) Touch the one-touch key of the desired destination.
- (3) Touch the [To] key.

☞ [CALLING UP A FAX NUMBER FROM THE ADDRESS BOOK](#) (page 36)

If the fax number of the transmitting machine is not stored in the Address Book, enter the fax number with the numeric keys.

☞ [ENTERING A FAX NUMBER WITH THE NUMERIC KEYS](#) (page 35)



You can touch the  key to display a list of the selected special mode settings or two-sided scanning. To return to the previous screen after checking the settings, touch the [OK] key.

5

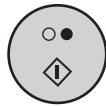

Press the [BLACK & WHITE START] key (○●).



**To cancel scanning**  
Press the [STOP] key (⊙).



- When the mixed size original setting is selected, two-sided copying cannot be used.
- This function cannot be used in combination with the following functions:  
Dual Page Scan, 2in1, Card Shot



**To cancel the mixed size original setting...**  
Touch the [Mixed Size Original] key in the screen of step 3 so that it is not highlighted.

# FAXING THIN ORIGINALS (Slow Scan Mode)

Use this function when you wish to scan thin originals using the automatic document feeder. This function helps prevent thin originals from misfeeding.



1

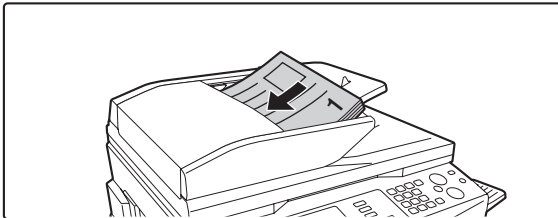

**Insert the originals face up in the document feeder tray.**

Adjust the document guides slowly.



If the originals are inserted with too much force, they may crumple and misfeed.

2

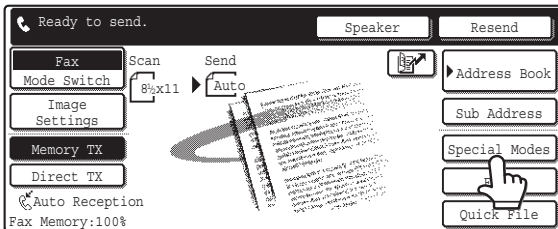

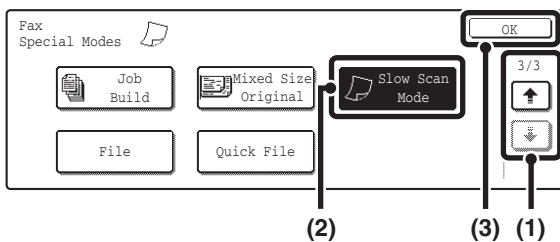

**Touch the [Special Modes] key.**

3



**Select slow scan mode.**

- (1) Touch the   keys to switch through the screens.
- (2) Touch the [Slow Scan Mode] key so that it is highlighted.
- (3) Touch the [OK] key.



4

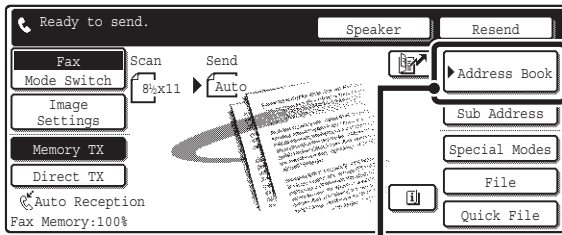

(1)

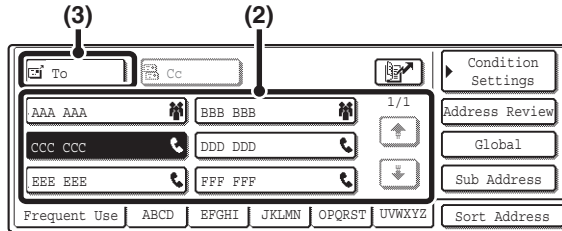

You can touch the  key to display a list of the selected special mode settings or two-sided scanning. To return to the previous screen after checking the settings, touch the [OK] key.

## Enter the destination fax number.

- (1) Touch the [Address Book] key.
- (2) Touch the one-touch key of the desired destination.
- (3) Touch the [To] key.

 [CALLING UP A FAX NUMBER FROM THE ADDRESS BOOK](#) (page 36)

If the fax number of the transmitting machine is not stored in the Address Book, enter the fax number with the numeric keys.

 [ENTERING A FAX NUMBER WITH THE NUMERIC KEYS](#) (page 35)

5



Press the [BLACK & WHITE START] key (○●).

 **To cancel scanning...**  
Press the [STOP] key (⊙).



**To cancel slow scan mode...**  
Touch the [Slow Scan Mode] key in the screen of step 3 so that it is not highlighted.

# SENDING A LARGE NUMBER OF PAGES (Job Build)

This function lets you separate a many-page original into sets, scan each set using the automatic document feeder, and transmit the pages in a single transmission. Use this function when the number of sheets that you wish to fax exceeds the maximum number of sheets (100 sheets) that can be inserted in the automatic document feeder at once.

When scanning the original in sets, divide the sheets so that no set has more than 100 sheets, and then scan from the set with the first page. The settings that you select for the first set can be used for all remaining sets.

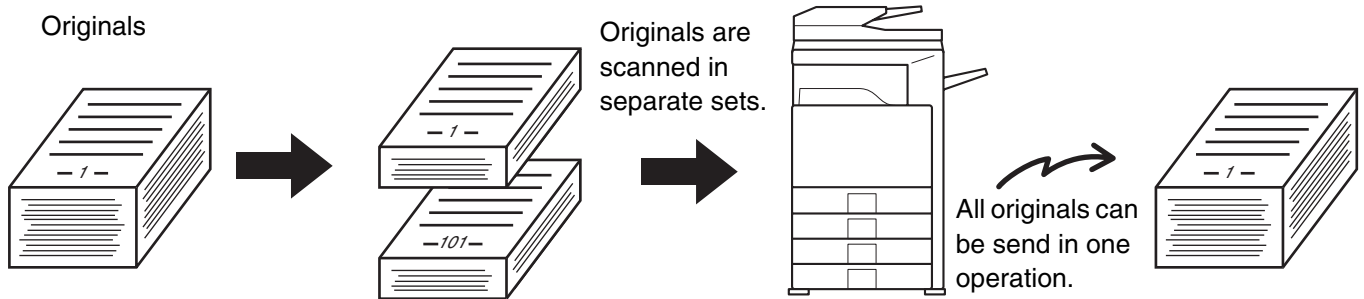

- Up to 999 pages can be scanned. Note that when the memory is being used for other jobs, fewer pages can be scanned.
- This function cannot be used in direct transmission mode or when using the speaker.

1

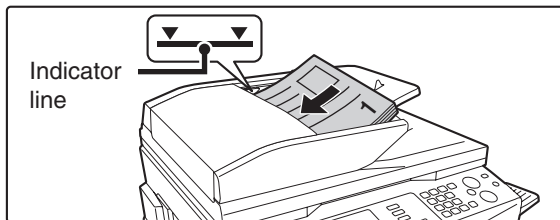

## Insert the originals face up in the document feeder tray.

Place the originals face up. Insert the originals all the way into the document feeder tray. The stack must not be higher than the indicator line (no more than 100 sheets).

2

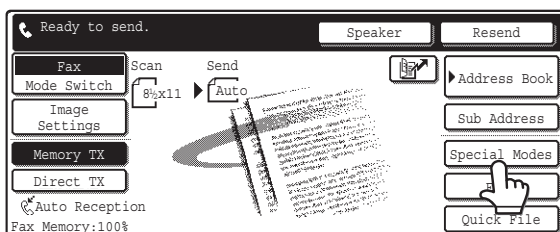

## Touch the [Special Modes] key.

3

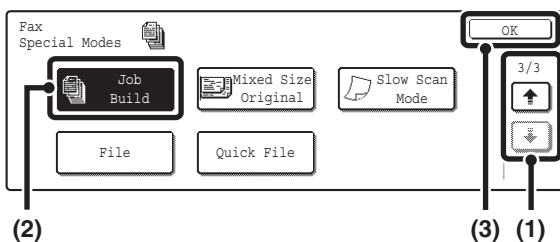

## Select job build mode.

- (1) Touch the keys to switch through the screens.
- (2) Touch the [Job Build] key so that it is highlighted.
- (3) Touch the [OK] key.

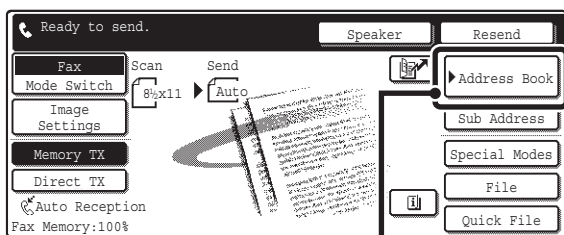

(1)

## Enter the destination fax number.

- (1) Touch the [Address Book] key.
- (2) Touch the one-touch key of the desired destination.
- (3) Touch the [To] key.

☞ [CALLING UP A FAX NUMBER FROM THE ADDRESS BOOK](#) (page 36)

If the fax number of the transmitting machine is not stored in the Address Book, enter the fax number with the numeric keys.

☞ [ENTERING A FAX NUMBER WITH THE NUMERIC KEYS](#) (page 35)

4

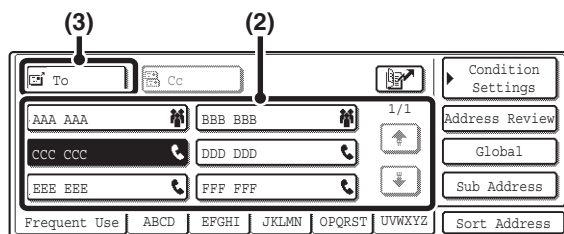

You can touch the  key to display a list of the selected special mode settings or two-sided scanning. To return to the previous screen after checking the settings, touch the [OK] key.

5



Press the [BLACK & WHITE START] key (○●) to scan the first set.



**To cancel scanning...**  
Press the [STOP] key (⊙).

6

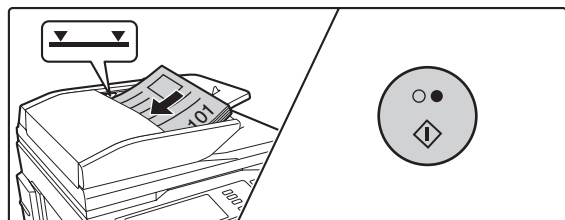

Insert the next set of originals and press the [BLACK & WHITE START] key (○●).

Place the originals face up. Insert the originals all the way into the document feeder tray. The stack must not be higher than the indicator line (no more than 100 sheets). Repeat until all sets of originals have been scanned.



If no action is taken for one minute after the final original is scanned, scanning automatically ends and the transmission is entered in the job queue.

7

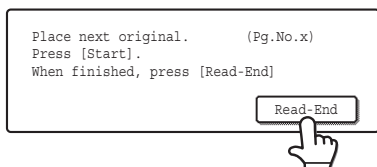

Touch the [Read-End] key.



- If the memory becomes full during scanning, a message will appear and the transmission will be canceled.
- This function cannot be used in combination with the following functions:  
Dual Page Scan, Card Shot



### To cancel the job build function....

Touch the [Job Build] key in the screen of step 3 so that it is not highlighted.

# CALLING A FAX MACHINE AND INITIATING RECEPTION (Polling)

The Polling function allows the receiving machine to call the transmitting machine and initiate reception of a document in that machine.

Because the receiving machine initiates reception of a document, this is called "Polling Reception".

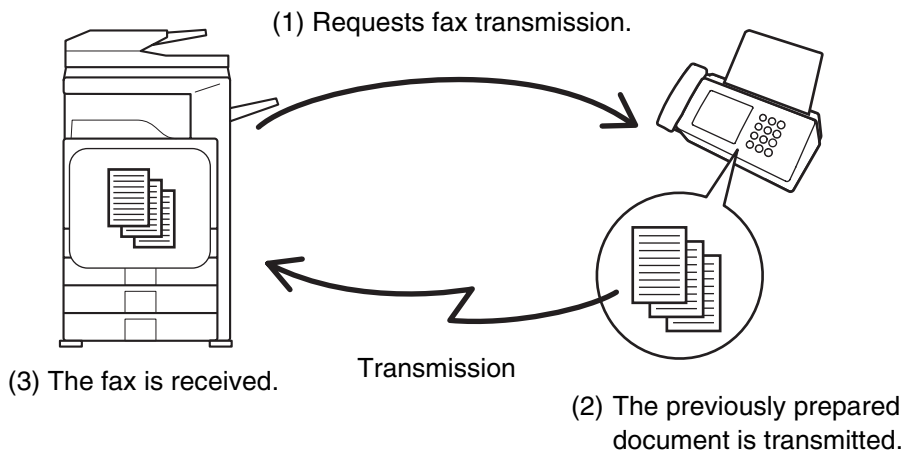

Make sure that an original is not placed in the machine when using the polling reception function.

1



Touch the [Special Modes] key.

2

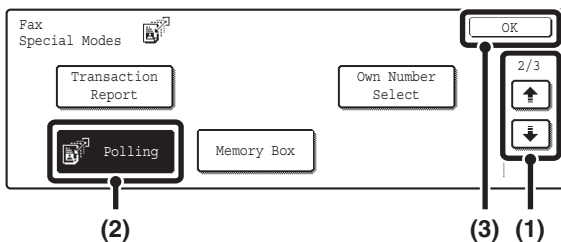

Select polling reception.

- (1) Touch the keys to switch through the screens.
- (2) Touch the [Polling] key so that it is highlighted.
- (3) Touch the [OK] key.

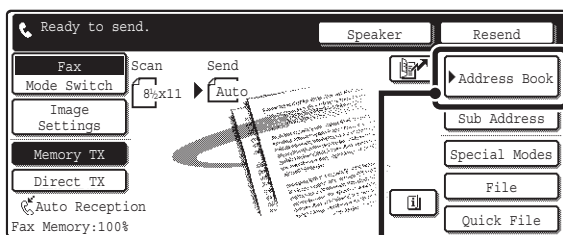

(1)

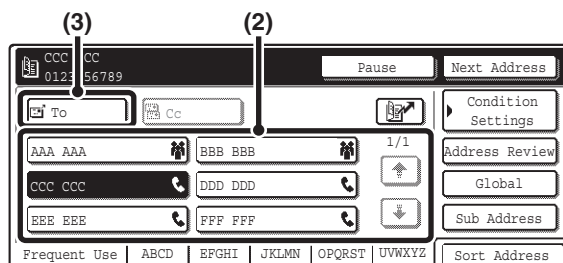

3

## Enter the fax number of the transmitting machine.

- (1) Touch the [Address Book] key.
- (2) Touch the one-touch key of the desired destination.
- (3) Touch the [To] key.

If you wish to enter multiple fax numbers, repeat steps (2) and (3) above to enter each number.

☞ [CALLING UP A FAX NUMBER FROM THE ADDRESS BOOK](#) (page 36)

If the fax number of the transmitting machine is not stored in the Address Book, enter the fax number with the numeric keys. To enter multiple fax numbers with the numeric keys, touch the [Next Address] key after entering a fax number and enter the next fax number.

☞ [ENTERING A FAX NUMBER WITH THE NUMERIC KEYS](#) (page 35)



### Multiple fax numbers can be entered.

Polling will take place in the order that the numbers were entered.

Polling multiple machines is called "Serial Polling".

Up to 500 fax numbers can be entered. In this procedure, one-touch keys that have a sub-address and passcode cannot be used.

4



## Press the [BLACK & WHITE START] key (○●).

Your machine will call the other machine and initiate reception of the fax.



- Polling reception can be used in combination with the timer function to poll at any specified time, such as at night or when you are not present.
- This function can only be used when the other machine is Super G3 or G3 compatible and has a polling function.
- The receiving machine bears the expense (phone charges) of the polling reception.



### To cancel polling reception...

Touch the [Polling] key in the screen of step 2.

# INITIATING POLLING RECEPTION MANUALLY

Use this procedure when you must start polling after listening to a recorded greeting, such as when using a fax information service.



- Make sure that an original is not placed in the machine when using the polling reception function.
- This function cannot be used to poll multiple machines (serial polling).

1

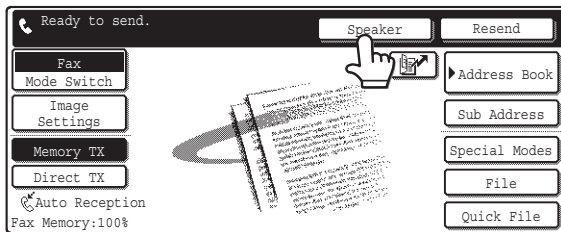

Touch the [Speaker] key.

2

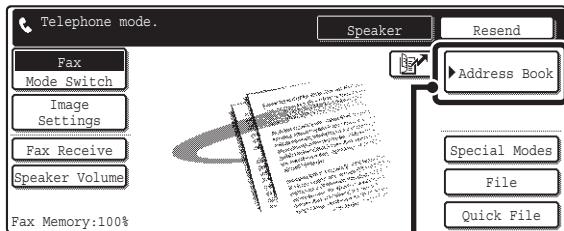

Enter the fax number of the transmitting machine.

- (1) Touch the [Address Book] key.
- (2) Touch the one-touch key of the desired destination.

A group key cannot be used.

☞ [CALLING UP A FAX NUMBER FROM THE ADDRESS BOOK](#) (page 36)

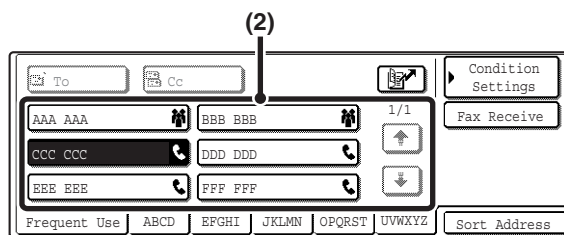

If the fax number of the transmitting machine is not stored in the Address Book, enter the fax number with the numeric keys.

☞ [ENTERING A FAX NUMBER WITH THE NUMERIC KEYS](#) (page 35)

3



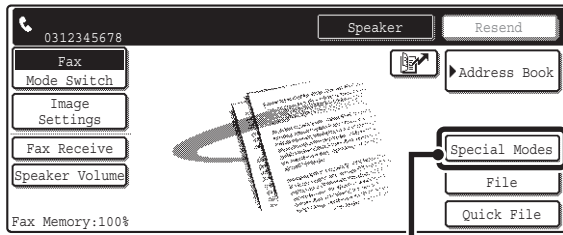

Follow the instructions in the recorded greeting.



(1)

## Receive the fax.

- (1) Touch the [Special Modes] key.
- (2) Touch the   keys to switch through the screens.
- (3) When you hear the fax tone, touch the [Polling] key.

The fax is received.

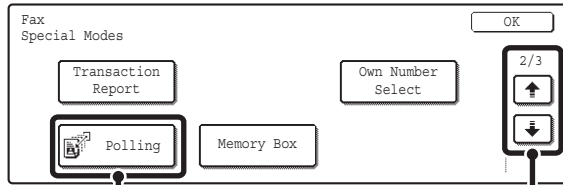

(3)

(2)



- This function can only be used when the other machine is Super G3 or G3 compatible and has a polling function.
- The receiving machine bears the expense (phone charges) of the polling reception.

---

---

# SENDING A FAX WHEN ANOTHER MACHINE POLLS YOUR MACHINE (Polling memory)

Sending a document that has been scanned into memory when another machine polls your machine is called "Polling Memory".

Prior to polling, the document that will be faxed to the other machine must be scanned into the memory box for polling memory.

This function can only be used when the other machine is Super G3 or G3 compatible and has a polling function.

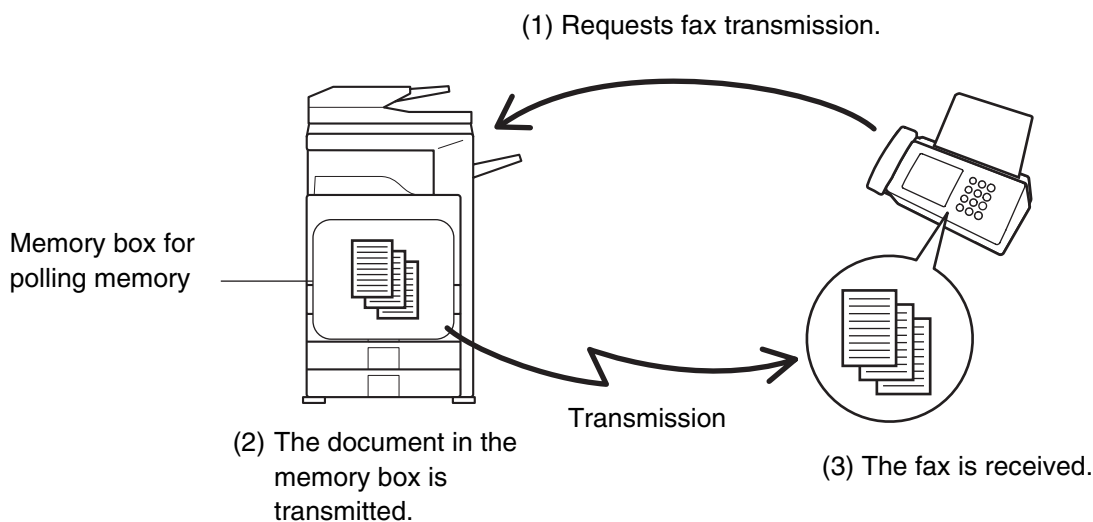

## RESTRICTING POLLING ACCESS (Polling security)

To only allow specified machines to poll your machine, you can restrict polling to machines whose programmed sender fax number matches a fax number stored in your machine as a polling passcode number. This is called "Polling Security".

To use this function, first store polling passcode numbers (the sender fax numbers programmed in the other machines) in the machine's system settings for fax, and then enable polling security.



Up to 10 fax numbers can be stored as polling passcode numbers.



- **System Settings for Fax (Administrator): [Polling Security Setting](#) (page 185)**  
This is used to enable polling security.
- **System Settings for Fax (Administrator): [Passcode Number Setting](#) (page 185)**  
This is used to store fax numbers as polling passcode numbers.



# SCANNING A DOCUMENT INTO A MEMORY BOX FOR POLLING TRANSMISSION

Follow these steps to scan a document into the memory box (Public Box) for polling transmission.

1

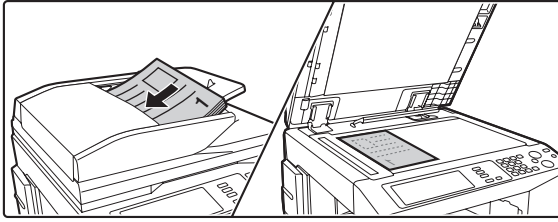

## Place the original.

Place the original face up in the document feeder tray, or face down on the document glass.

2

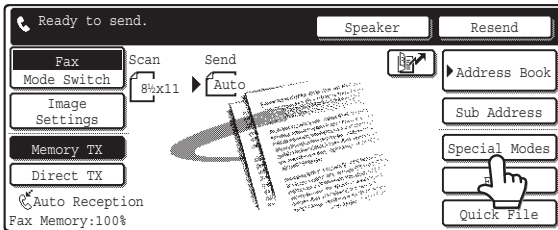

## Touch the [Special Modes] key.

3

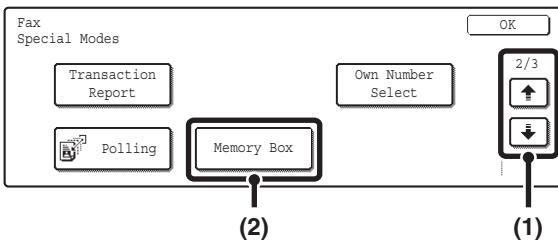

## Select memory box.

(1) Touch the   keys to switch through the screens.

(2) Touch the [Memory Box] key.

4

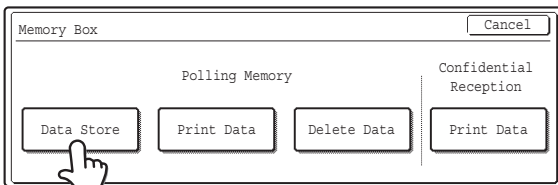

## Touch the [Data Store] key.

5

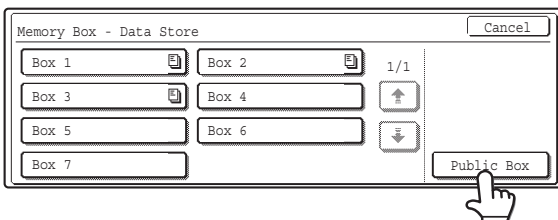

## Touch the [Public Box] key.

6

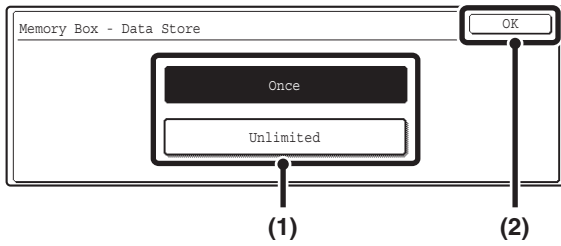

## Specify the number of polling times.

### (1) Touch the key for the desired number of times.

Touch the [Once] key if you want the document cleared from memory after it is transmitted. Touch the [Unlimited] key to allow polling an unlimited number of times.

### (2) Touch the [OK] key.

7

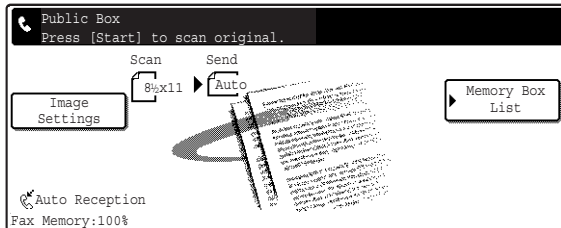

## Select image settings and special modes.

To select image settings (exposure, resolution, original size, and two-sided original) and special mode settings, touch the [Image Settings] key.



The following functions can be selected: Erase, Dual Page Scan, 2in1, Card Shot, Job Build, Mixed Size Original, Slow Scan Mode, Own Number Select.

8

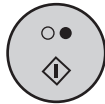

## Press the [BLACK & WHITE START] key (○●).

Scanning begins.

- If you inserted the original pages in the document feeder tray, all pages are scanned.
- If you are scanning the original on the document glass, scan each page one page at a time.

When scanning finishes, place the next original and press the [BLACK & WHITE START] key (○●). Repeat until all pages have been scanned and then press the [Read-End] key.



### To cancel scanning...

Press the [STOP] key (⊞) while the original is being scanned.



If another document remains in the memory box (public box), the newly scanned document is added to the previous document. In this case, the number of polling times will be the number set for the newly scanned document.

# PRINTING A DOCUMENT STORED IN THE PUBLIC BOX

To check a document stored in the public box for polling transmission, follow the steps below to print the document.

**1**

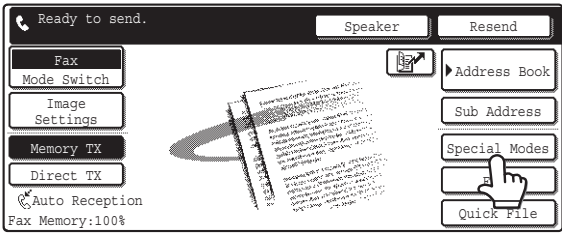

Ready to send. Speaker Resend

Fax Mode Switch Image Settings Memory TX Direct TX Auto Reception Fax Memory:100%

Address Book Sub Address Special Modes Quick File

**Touch the [Special Modes] key.**

**2**

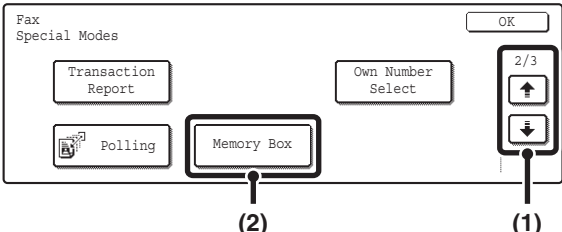

Fax Special Modes OK



Transaction Report Own Number Select

Polling Memory Box

2/3

(1) (2)

**Select memory box.**

(1) Touch the   keys to switch through the screens.

(2) Touch the [Memory Box] key.

**3**

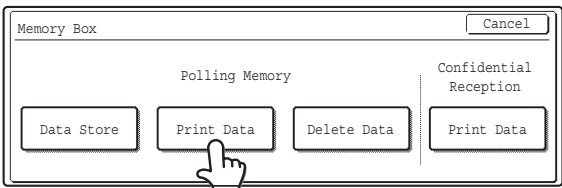

Memory Box Cancel

Polling Memory Confidential Reception

Data Store Print Data Delete Data Print Data

**Touch the [Print Data] key.**

**4**

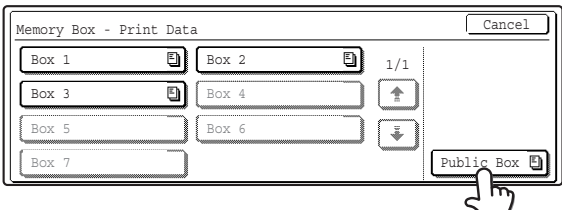

Memory Box - Print Data Cancel

Box 1 Box 2 1/1

Box 3 Box 4

Box 5 Box 6

Box 7 Public Box

**Touch the [Public Box] key.**

 When nothing is stored in the public box, the [Public Box] key will be grayed out.

**5**



**Press the [BLACK & WHITE START] key (○●).**

The stored document is printed.

 **To cancel printing...**

Touch the [Cancel] key in the touch panel.

# DELETING A DOCUMENT FROM THE PUBLIC BOX

Delete a document from the public box when it is no longer needed.

**1**

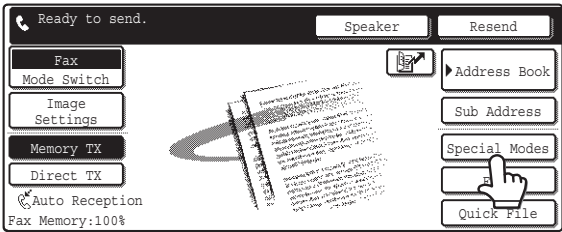

Ready to send. Speaker Resend

Fax Mode Switch

Image Settings

Memory TX

Direct TX

Auto Reception

Fax Memory:100%

Address Book

Sub Address

Special Modes

Quick File

**Touch the [Special Modes] key.**

**2**

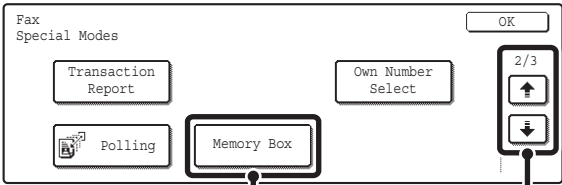

Fax Special Modes OK

Transaction Report

Own Number Select



Polling

Memory Box

(2)

(1)

**Select memory box.**

(1) Touch the   keys to switch through the screens.

(2) Touch the [Memory Box] key.

**3**

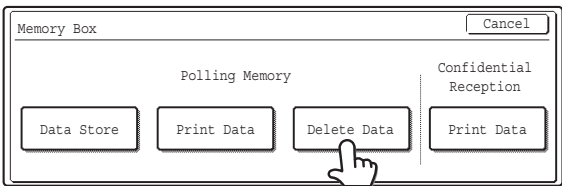

Memory Box Cancel

Polling Memory Confidential Reception

Data Store Print Data Delete Data Print Data

**Touch the [Delete Data] key.**

**4**

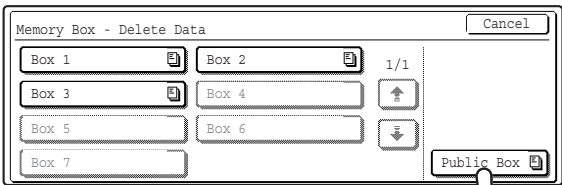

Memory Box - Delete Data Cancel

Box 1 Box 2 1/1

Box 3 Box 4

Box 5 Box 6

Box 7 Public Box

**Touch the [Public Box] key.**

**5**

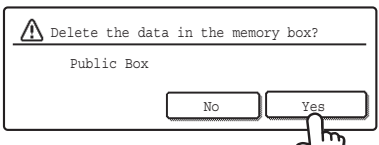

Delete the data in the memory box?

Public Box

No Yes

**Touch the [Yes] key.**

The document is deleted and you return to the screen of step 2.

 **To cancel the deletion...**  
Touch the [No] key. You will return to the screen of step 2.

---

---

# FORWARDING RECEIVED FAXES (Fax Data Forward)

When the machine cannot print because it is out of paper or out of toner, received faxes can be forwarded to another previously programmed fax machine.

This function is convenient in an office or work area that has two or more telephone lines and another fax machine is connected to a different line than the machine.

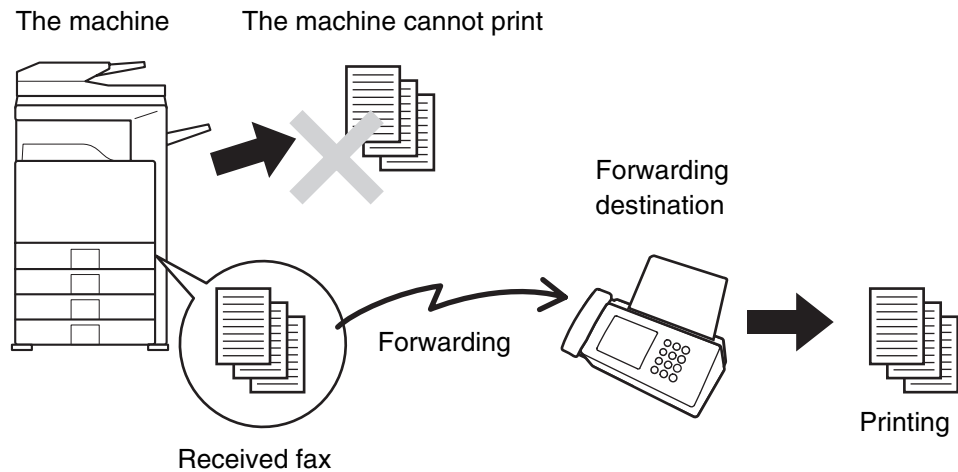

1



Press the [SYSTEM SETTINGS] key.

2

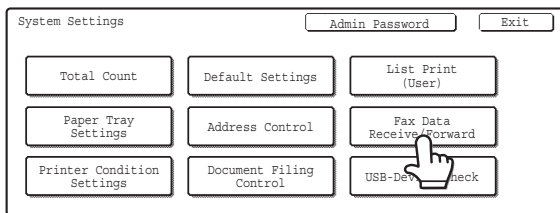

Touch the [Fax Data Receive/Forward] key.

3

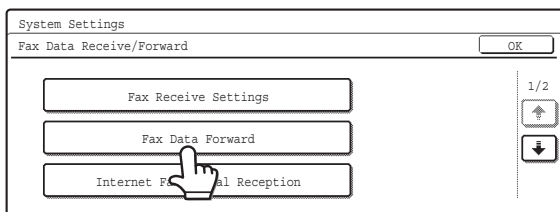

Touch the [Fax Data Forward] key.

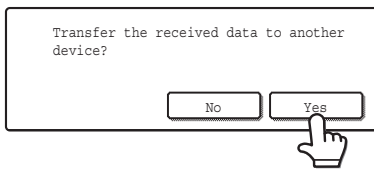

## Touch the [Yes] key.

Your machine dials the destination machine and transmits the fax.



If a password entry screen appears after the [Yes] key is touched, "Hold Setting For Received Data Print" has been enabled for received faxes. Enter the password with the numeric keys to begin forwarding.

 [PRINTING A PASSWORD-PROTECTED FAX \(Hold Setting For Received Data Print\)](#) (page 47)



### To cancel forwarding...

Touch the [No] key. The job becomes a fax reception job again and is held in memory until it can be printed.



- If some pages of a fax that is being forwarded were successfully printed, only those pages that were not printed will be forwarded.
- A forwarded fax becomes a fax transmission job. If transmission does not take place because the transmission was canceled or an error occurred, the fax will be held in memory until it can be printed.
- All faxes received are forwarded. Note, however, that faxes received to an F-code confidential memory box cannot be forwarded.



### System Settings for Fax (Administrator): [Set the Telephone Number for Data Forwarding](#) (page 183)

This is used to store the forwarding fax number.

---

---

# SENDING A FAX DIRECTLY FROM A COMPUTER (PC-Fax)

A document on a computer can be transmitted via the machine as a fax. Faxes are sent using the PC-Fax function in the same way as documents are printed. Select the PC-Fax driver as the printer driver for your computer and then select the Print command in the software application. Image data for transmission will be created and sent as a fax.

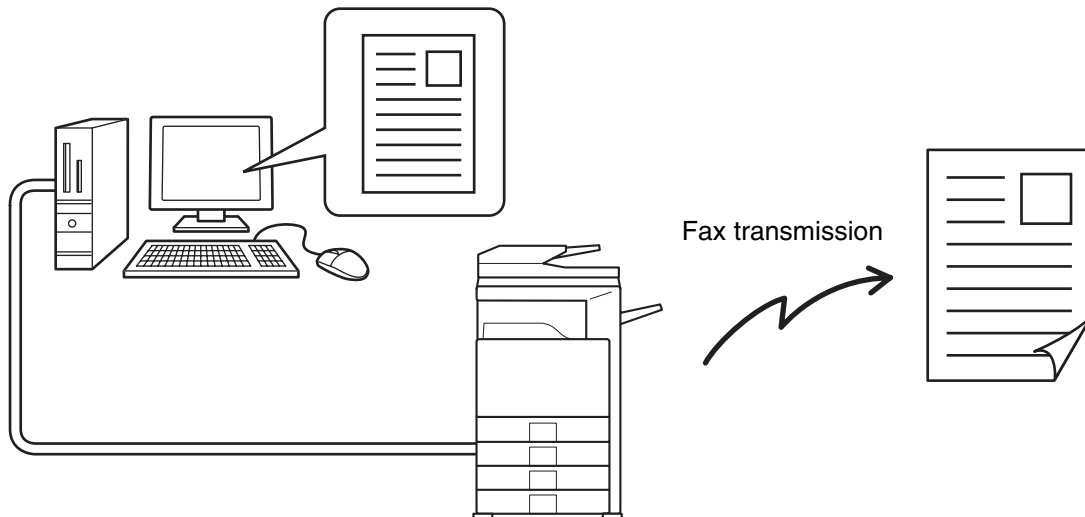

For more information on using PC-Fax, see the Help file for the PC-Fax driver.

- The PC-Fax driver is on the "Software CD-ROM" that accompanies the machine. For the installation procedure and system requirements, see the Software Setup Guide.
- This function can only be used when the printer function can be used.
- This function can only be used on a Windows® computer.
- This function can only be used to send faxes. Faxes received by the machine cannot be received to your computer.

---

---

# FORWARDING A RECEIVED FAX TO AN E-MAIL ADDRESS (Inbound Routing Settings)

Received faxes can be automatically forwarded to a specified E-mail address. This function can be used to forward received faxes directly to an e-mail address without printing the faxes.

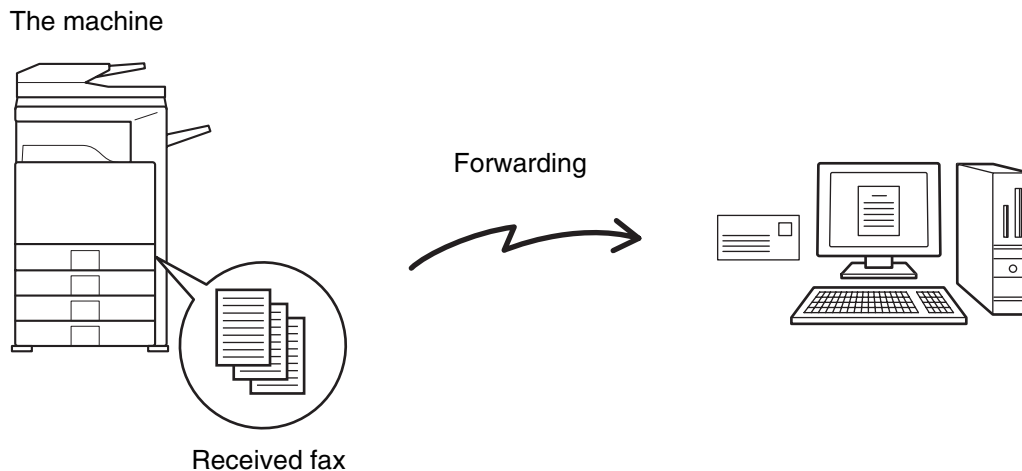

To configure inbound routing settings, click [Application Settings] and then [Inbound Routing Settings] in the Web page menu. (Administrator rights are required.)



- The format, exposure, and resolution settings of the received fax remain in effect when the fax is forwarded.
- This function cannot be used for faxes received by confidential reception.



# 8

# PERFORMING F-CODE COMMUNICATION

This chapter explains how to perform F-code communication operations. F-code communication is possible with machines of other manufacturers that also support F-code communication.

## F-CODE COMMUNICATION

Exchange of confidential documents (confidential communication), retrieval (polling) and distribution (polling memory) of information, distribution of information to multiple destinations (relay broadcast transmission) are possible with other machines that support F-code communication.

An F-code\* is specified in each communication, enabling a higher level of security.

\* F-code is a communication function based on the G3 standard of the ITU-T.

 The ITU-T is a United Nations organization that establishes communications standards. It is a department of the International Telecommunication Union (ITU), which coordinates global telecommunications networks and services.

## HOW F-CODES WORK

A fax that is transmitted with an F-code is received to the memory box in the receiving machine specified by the F-code (sub-address and passcode). If the F-code sent by the transmitting machine does not match the F-code in the receiving machine, reception will not take place.

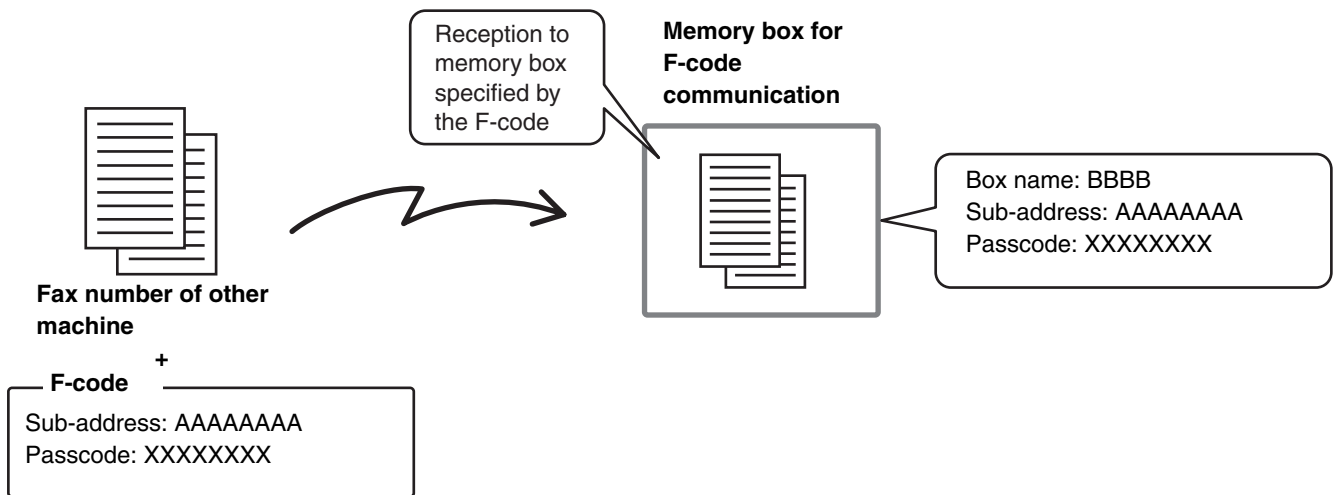

The products of other manufacturers may use different terms for "sub-address" and "passcode". If you need to contact the operator of another machine regarding sub-addresses and passcodes, refer to the terms in the table below which are used by the ITU-T.

Your machine	ITU-T		
	F-code polling memory box	F-code confidential box	F-code relay broadcast memory box
Sub-address	SEP	SUB	SUB
Passcode	PWD	SID	SID

 An F-code consists of a sub-address and passcode, and cannot be longer than 20 digits.

# CREATING MEMORY BOXES IN THE MACHINE FOR F-CODE COMMUNICATION

Before the F-code communication function can be used, special memory boxes must be created using "F-Code Memory Box" in the system settings for fax.

A box name and F-code (sub-address and passcode) are programmed in each box, and an F-code communication function is assigned to each box.

After you have created a memory box, inform the other party of the sub-address and passcode of the box.

## Memory box for F-code communication



- Memory box name
- Sub-address
- Passcode
- End receiving machines (only in an F-code relay broadcast memory box)
- Print PIN (only for F-code confidential reception)

To use the following F-code communication functions, F-code memory boxes must be created in your machine.

F-code confidential reception, F-code polling memory, F-code relay broadcast transmission

To use the following F-code communication functions, F-code memory boxes must be created in the other machine.

F-code confidential transmission, F-code polling reception, F-code relay request transmission



### System Settings for Fax: F-Code Memory Box

This is used to configure memory boxes for F-code communication.

- Up to 100 memory boxes can be created.
- The memory box name cannot be longer than 18 characters, and the sub-address and passcode cannot be longer than 20 digits.

 [Programming an F-code Memory Box \(Polling Memory\)](#) (page 149), [Programming an F-code Memory Box \(Confidential\)](#) (page 151), [Programming an F-code Memory Box \(Relay Broadcast\)](#) (page 154)

# F-CODE DIALING

When performing an F-code operation, the F-code (sub-address and passcode) is appended to the fax number that is dialed. Check the F-code (sub-address and passcode) programmed in the memory box in the other machine before you perform an F-code transmission. It is convenient to store an F-code together with the fax number in a one-touch key or group key.

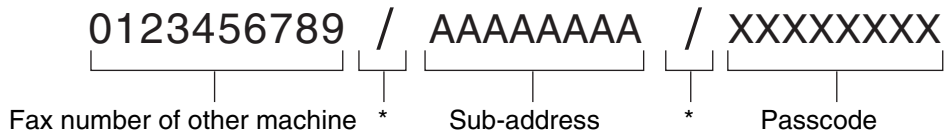

\* Touch the [Sub Address] key in the screen to enter "/" .



When the following F-code functions are used, your machine dials the other machine.

F-code confidential transmission, F-code polling reception, F-code relay request transmission

When the following F-code functions are used, the other machine dials your machine.

F-code confidential reception, F-code polling memory, F-code relay broadcast transmission

-  If the destination machine does not have a passcode configured in the F-code, do not enter a passcode when dialing that machine.
- F-code communication cannot be performed when using the speaker or performing manual transmission.

-  **System Settings for Fax: Address/Program**  
This is used to store and edit one-touch keys and group keys.
  -  [Storing a One-touch \(Individual\) Key for Fax](#) (page 135), [Storing a Group Key](#) (page 140), [Modify/Delete a One-touch Key or Program](#) (page 146)

---

---

# CONFIDENTIAL COMMUNICATION USING F-CODES

By sending a fax to an F-code memory box (confidential) in the receiving machine (your machine or the other machine), the sender can direct the transmission specifically to the user of the box.

This is convenient for sending sensitive documents that you do not wish people other than the recipient to see, or when the receiving machine is shared by multiple departments.

To print an F-code confidential fax, the print passcode must be entered.

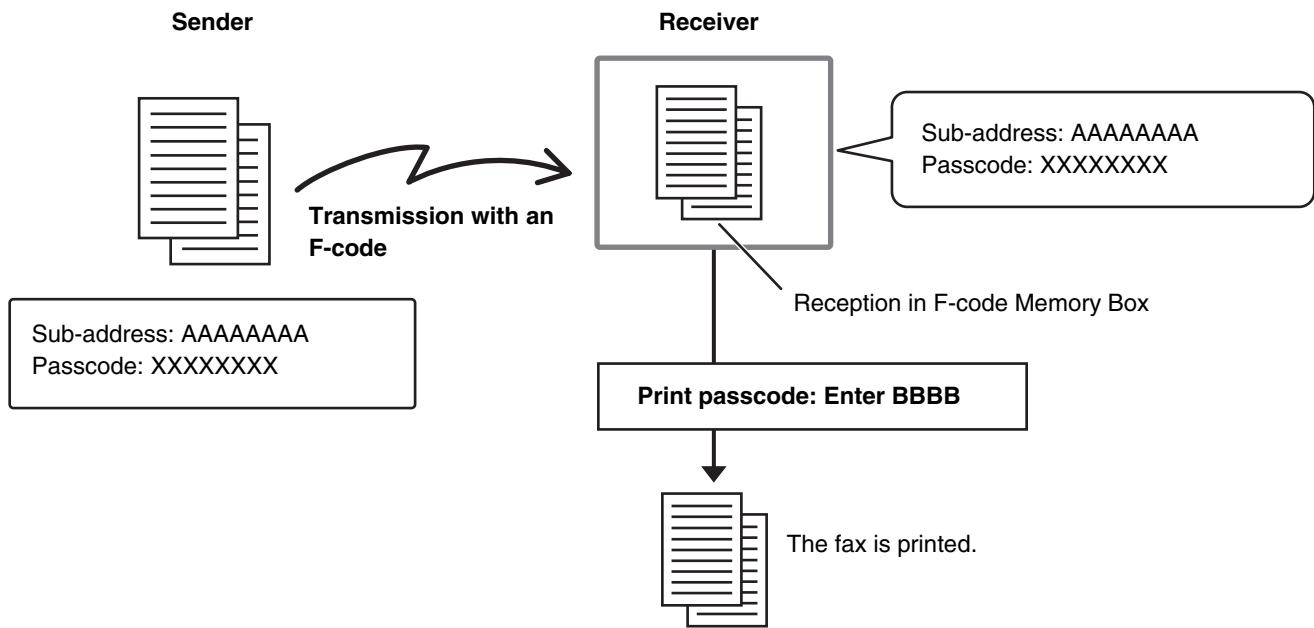

 The F-code (sub-address and passcode) of the memory box to be used should be verified by the sender and the recipient before the fax is sent.



## System Settings for Fax: F-code Memory Box

This is used to create memory boxes for F-code confidential communication (confidential).

A memory box name, sub-address, passcode, and print passcode are programmed in each box.

 [Programming an F-code Memory Box \(Confidential\)](#) (page 151)

# F-CODE CONFIDENTIAL TRANSMISSION

Follow the steps below to send a confidential fax by adding an F-code to the fax number.

1

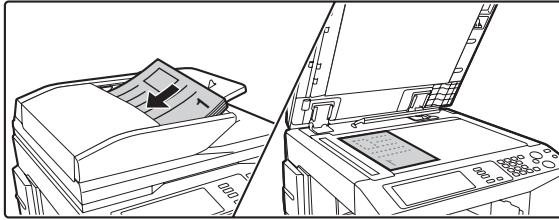

## Place the original.

Place the original face up in the document feeder tray, or face down on the document glass.

2

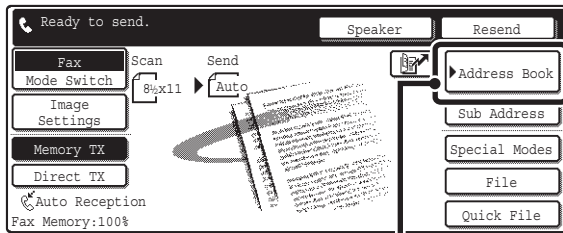

(1)

## Enter the destination fax number.

(1) Touch the [Address Book] key.

(2) Touch the one-touch key of the desired destination.

Touch the one-touch key in which the destination fax number and F-code are stored.

(3) Touch the [To] key.

 [CALLING UP A FAX NUMBER FROM THE ADDRESS BOOK](#) (page 36)

If the fax number of the transmitting machine is not stored in a one-touch key in the Address Book, enter the fax number and F-code with the numeric keys.

(1) Enter the fax number of the destination.

(2) Touch the [Sub Address] key to enter "/".

(3) Enter the sub-address.

(4) Touch the [Sub Address] key to enter "/".

(5) Enter the passcode.

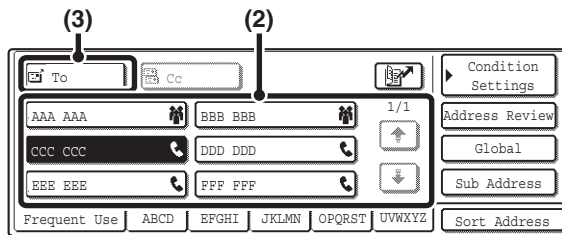

3



## Press the [BLACK & WHITE START] key (○●).

Scanning begins.

- If you inserted the original pages in the document feeder tray, all pages are scanned.

A beep will sound to indicate that scanning is finished.

- If you are scanning the original on the document glass, scan each page one page at a time. When scanning finishes, place the next original and press the [BLACK & WHITE START] key (○●). Repeat until all pages have been scanned and then press the [Read-End] key.

A beep will sound to indicate that scanning is finished.



This function can be used in combination with a broadcast transmission or timer transmission. A F-code confidential transmission can also be stored in a program.

# PRINTING A FAX RECEIVED BY F-CODE CONFIDENTIAL RECEPTION

An F-code confidential fax sent to your machine is received to the memory box specified by the F-code. To print the received fax, enter the print passcode.

1

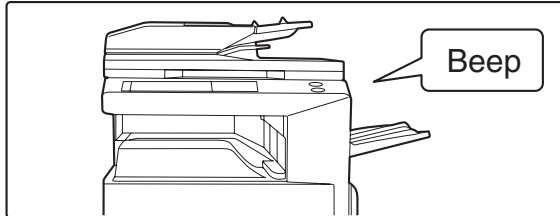

**The machine rings and the fax is received.**

A beep sounds when reception ends.

2

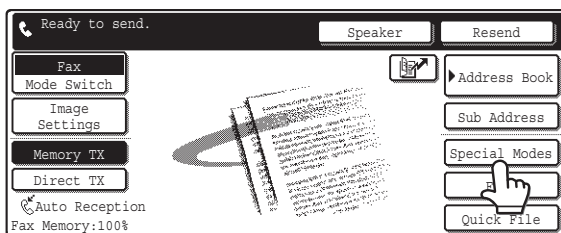

**Touch the [Special Modes] key.**

3

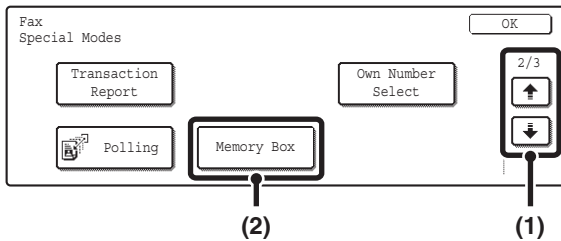

**Select memory box.**

(1) Touch the keys to switch through the screens.

(2) Touch the [Memory Box] key.

4

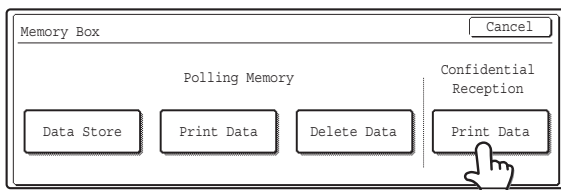

**Touch the [Print Data] key.**

5

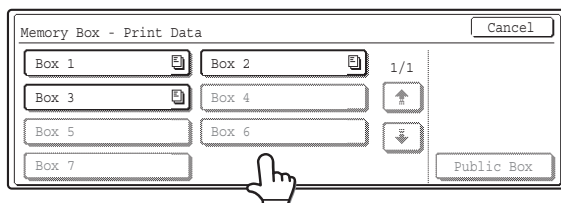

**Touch the key of the memory box containing the confidential fax.**

"" appears in the keys of memory boxes that have received faxes. The keys of memory boxes that have not received faxes are grayed out and cannot be selected.

6



## Enter the print passcode with the numeric keys.

As each digit is entered, "-" changes to "\*".



Take care to enter the correct print passcode. If you make a mistake, a message will appear. Return to the entry screen. You can touch the [Cancel] key to return to step 5.

7



## Press the [BLACK & WHITE START] key (○●).



- The confidential fax is automatically given priority in the print job queue.
- The fax is automatically cleared from the memory box after printing.

• **If you forget the print passcode...**

There is no way to check a forgotten passcode on the machine. Take care not to forget the passcode. In the event that you forget the passcode or need to verify the passcode, contact your dealer or nearest SHARP Service Department.



**System Settings for Fax (Administrator): [Transaction Report Print Select Setting](#) (page 179)**

This setting can be used to have a transaction report printed automatically when an F-code confidential fax is received.

# POLLING RECEPTION USING F-CODES

This function enables your machine to call another machine and initiate reception of a fax stored in an F-code memory box (polling memory) in the other machine. During the polling operation, your machine must correctly specify the F-code (sub-address and passcode) configured in the other machine or polling reception will not take place.

## Transmission request (polling) using an F-code

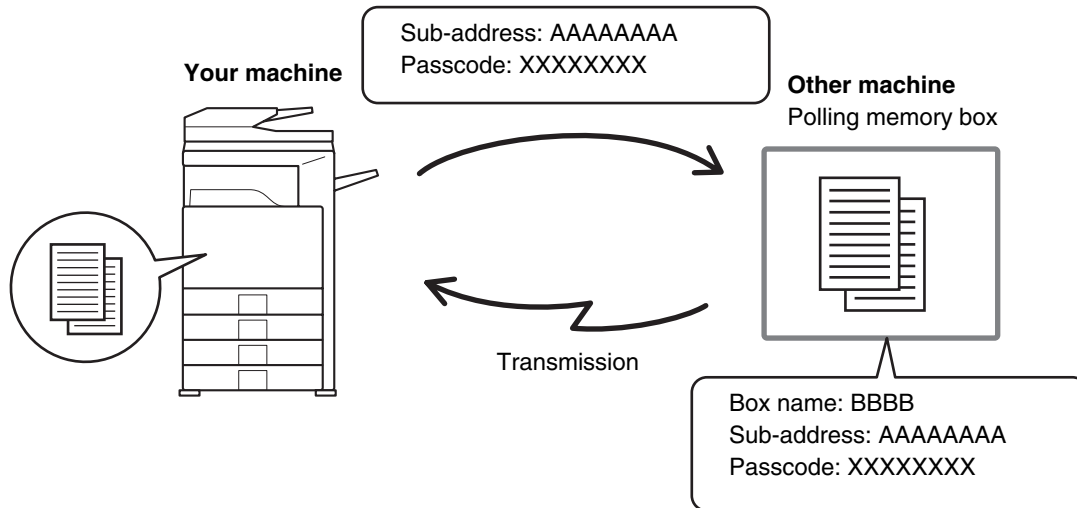

- Verify the F-code (sub-address and passcode) of the memory box in the other machine before you perform F-code polling reception.
- Do not place an original in the automatic document feeder or on the document glass when using this function.
- The receiving machine bears the phone charges of the transmission.

1

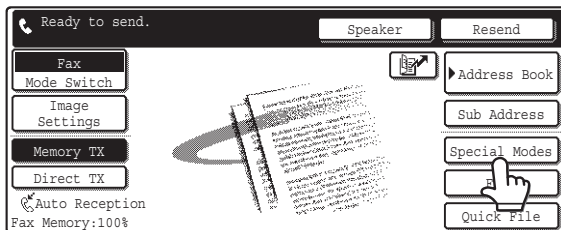

Touch the [Special Modes] key.

2

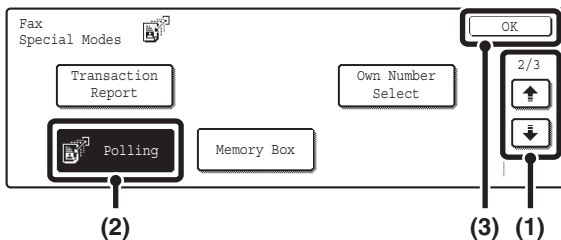

Select polling.

- (1) Touch the keys to switch through the screens.
- (2) Touch the [Polling] key.
- (3) Touch the [OK] key.



3

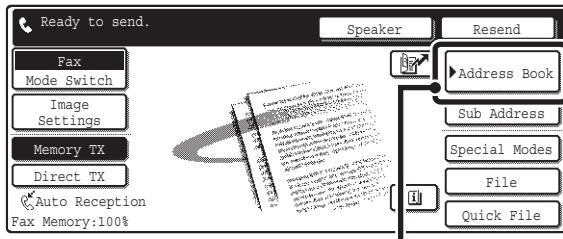

(1)

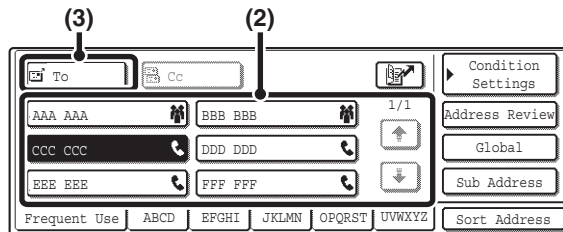

## Enter the destination fax number.

- (1) Touch the [Address Book] key.
- (2) Touch the one-touch key of the desired destination.

Touch the one-touch key in which the fax number and F-code of the relay machine are stored.

- (3) Touch the [To] key.

➤ [CALLING UP A FAX NUMBER FROM THE ADDRESS BOOK](#) (page 36)

If the fax number of the transmitting machine is not stored in a one-touch key in the Address Book, enter the fax number and F-code with the numeric keys.

- (1) Enter the fax number of the destination.
- (2) Touch the [Sub Address] key to enter "/".
- (3) Enter the sub-address.
- (4) Touch the [Sub Address] key to enter "/".
- (5) Enter the passcode.

4



## Press the [BLACK & WHITE START] key (○●).

Your machine will call the other machine and initiate reception of the fax.

- ✎ Polling multiple machines (serial polling) is not possible.
- ✎ F-code polling reception can be used in combination with a timer setting. Only one polling reception operation with a timer setting can be stored at a time.

- ↶ **To cancel polling...**  
Touch the [Polling] key in the screen of step 2.

# POLLING MEMORY TRANSMISSION USING F-CODES

When your machine receives a transmission request from another machine, this function sends a fax stored in an F-code memory box (polling memory) in your machine to that machine. The other machine must correctly specify the F-code configured in your machine or transmission will not take place.

The document to be transmitted must be scanned into an F-code polling memory box.

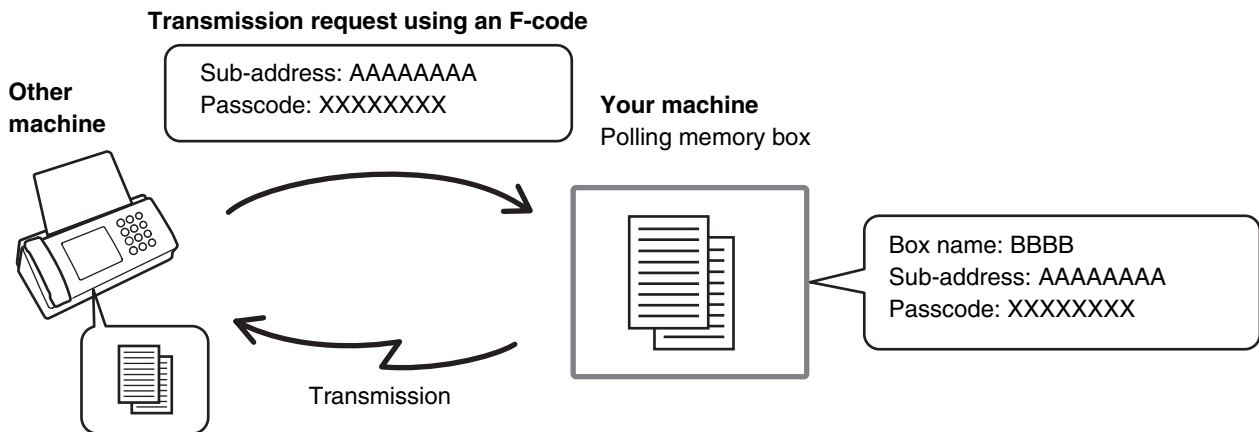

## System Settings for Fax: F-Code Memory Box

This is used to create memory boxes (polling memory) for F-code polling memory transmission.

A memory box name, sub-address, and passcode are programmed in each box.

[Programming an F-code Memory Box \(Polling Memory\)](#) (page 149)

# SCANNING A DOCUMENT INTO A MEMORY BOX FOR F-CODE POLLING TRANSMISSION

Follow these steps to scan a document into a memory box (Polling memory) for F-code polling transmission.

1

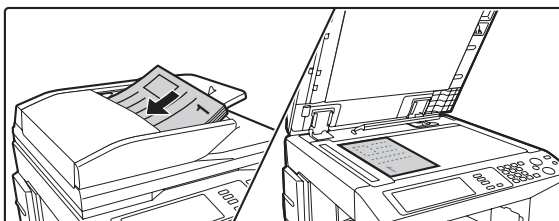

## Place the original.

Place the original face up in the document feeder tray, or face down on the document glass.

2

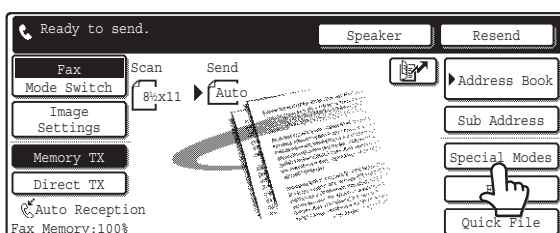

## Touch the [Special Modes] key.

3

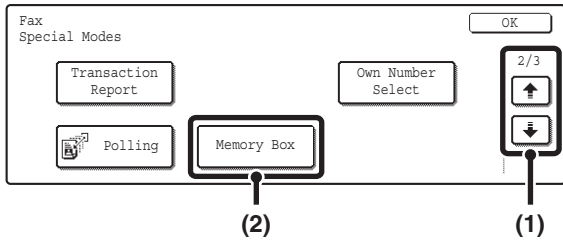

### Select memory box.

- (1) Touch the keys to switch through the screens.
- (2) Touch the [Memory Box] key.

4

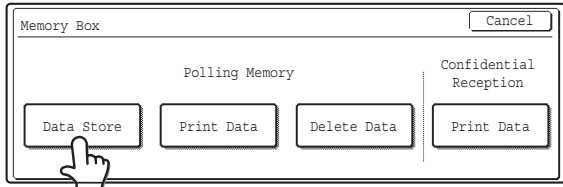

### Touch the [Data Store] key.

5

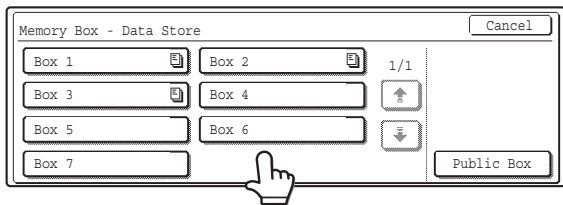

### Touch the key of the F-code memory polling box.

6

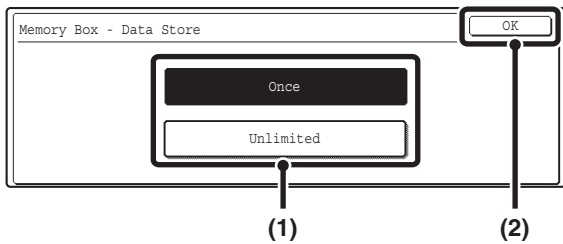

### Specify the number of polling times.

- (1) Touch the key for the desired number of times.  
Touch the [Once] key if you want the document cleared from memory after it is transmitted. Touch the [Unlimited] key to allow polling an unlimited number of times.
- (2) Touch the [OK] key.

7

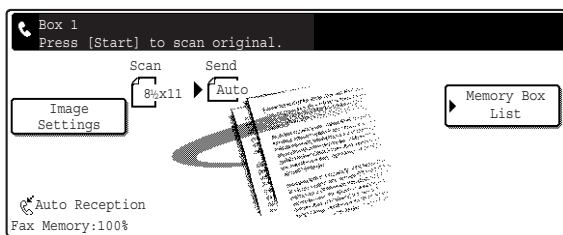

### Select original scanning settings and special modes.

Touch the [Image Settings] key to select original settings (exposure, resolution, original size, and two-sided original). To set special mode settings, touch the [Special Modes] key that is displayed when the [Image Settings] key is touched.



A program, timer setting, transaction report, polling, and document filing cannot be selected.



## Press the [BLACK & WHITE START] key (○●).

Scanning begins.

- If you inserted the original pages in the document feeder tray, all pages are scanned.
- If you are scanning the original on the document glass, scan each page one page at a time.

When scanning finishes, place the next original and press the [BLACK & WHITE START] key (○●). Repeat until all pages have been scanned and then press the [Read-End] key.



### To cancel scanning...

To cancel scanning, press the [STOP] key (⊞) during scanning.



- If other documents have already been stored in the memory box, the document is added to the previously stored documents.
- The factory default setting for the number of polling times is "Once" (after the document is transmitted to the receiving machine, it is automatically cleared).

# PRINTING A DOCUMENT STORED FOR F-CODE POLLING TRANSMISSION

You can check a document in an F-code memory polling box (public box) by printing it out.



A document in a memory box cannot be printed while the document is being transmitted.

1



Touch the [Special Modes] key.

2

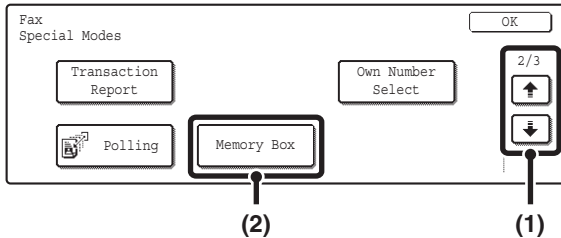

Select memory box.

(1) Touch the keys to switch through the screens.

(2) Touch the [Memory Box] key.

3

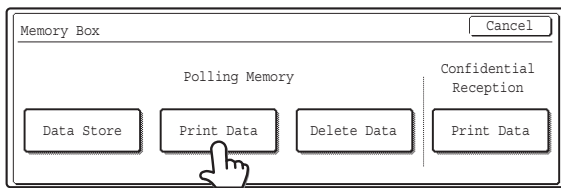

Touch the [Print Data] key.

4

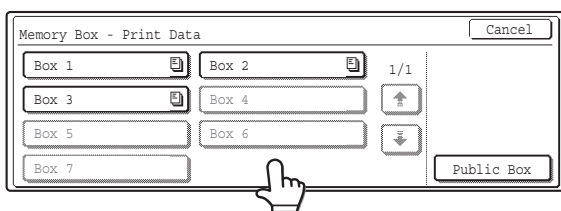

Touch the key of the F-code memory polling box where the document you wish to print is stored.

"" appears in keys that have documents stored.

5



Press the [BLACK & WHITE START] key (○●).

The document in the selected memory box is printed.



To cancel printing...  
Touch the [Cancel] key.

# DELETING A DOCUMENT STORED FOR F-CODE POLLING TRANSMISSION

When a document in an F-code memory polling box is no longer needed, follow the steps below to delete it.



A document in a memory box cannot be deleted while the document is being transmitted.

1



Touch the [Special Modes] key.

2

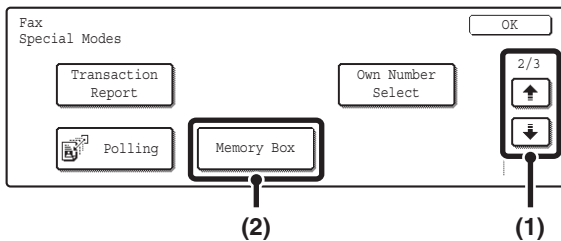

Select memory box.

(1) Touch the keys to switch through the screens.

(2) Touch the [Memory Box] key.

3

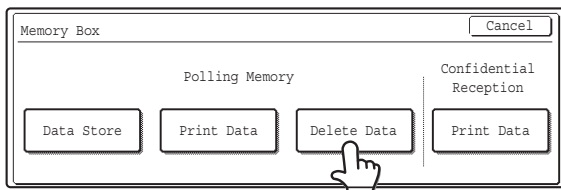

Touch the [Delete Data] key.

4

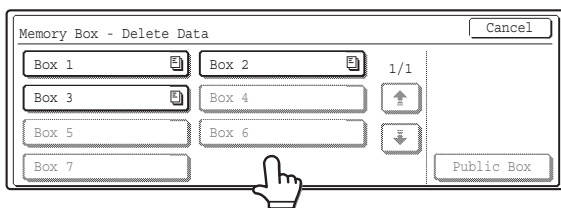

Touch the key of the F-code memory polling box that has the document you wish to delete.

"" appears in keys that have documents stored.

5

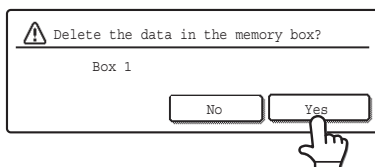

Touch the [Yes] key.

The document in the selected memory box is deleted and you return to the screen of step 2.



To cancel the deletion...

Touch the [No] key. You will return to the screen of step 4 without deleting the document.

# RELAY REQUEST TRANSMISSION USING F-CODES

This function is used to send a fax to an F-code memory box (relay broadcast) in another machine and have that machine relay the fax to multiple end receiving machines.

When the end receiving machines are far from your machine, sending the fax to a relay machine that is close to the end receiving machines can help reduce phone charges. A relay request transmission can be used in combination with the timer transmission function to further reduce phone costs.

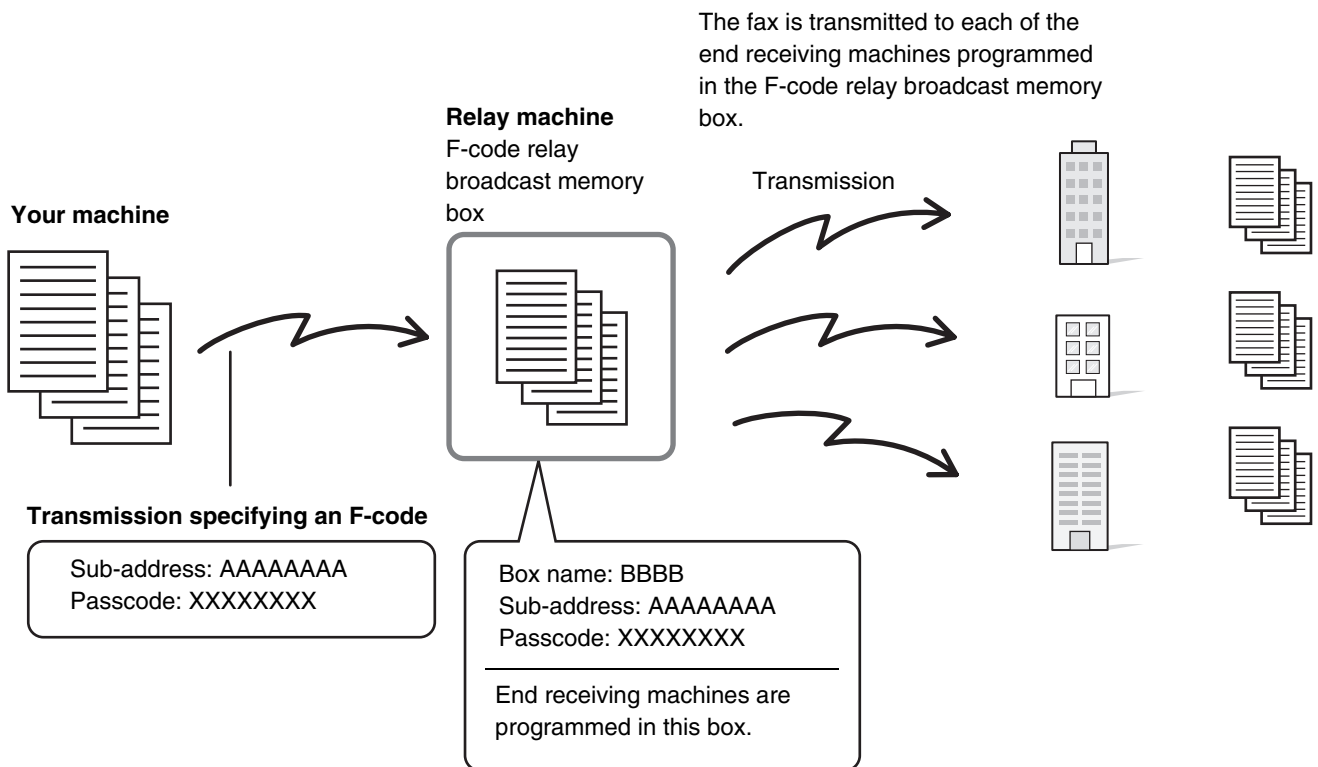

- Verify the F-code (sub-address and passcode) and end receiving machines programmed in the memory box (relay broadcast) before you perform an F-code relay request transmission.
- Before this function can be used, the end receiving machines must be programmed in the F-code memory box (relay broadcast) in the relay machine.
- The end receiving machines do not need to support F-code communication.
- This function can be used in combination with a broadcast transmission or timer transmission. An F-code relay request transmission can also be stored in a program.
- Your machine (the machine that requests a relay broadcast transmission) only bears the cost of sending the fax to the other machine (the relay machine). The other machine (the relay machine) bears the cost of sending the fax to each of the end receiving machines.



## System Settings for Fax: F-Code Memory Box

This is used to create memory boxes (relay broadcast) for F-code relay broadcast transmission. A memory box name, sub-address, passcode, and end receiving machines are programmed in each box.

[Programming an F-code Memory Box \(Relay Broadcast\)](#) (page 154)

1

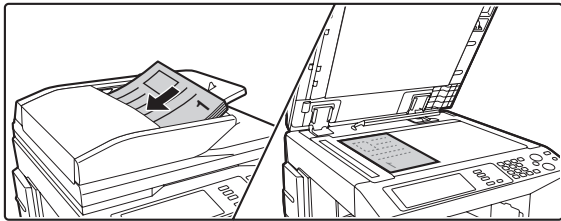

## Place the original.

Place the original face up in the document feeder tray, or face down on the document glass.

2

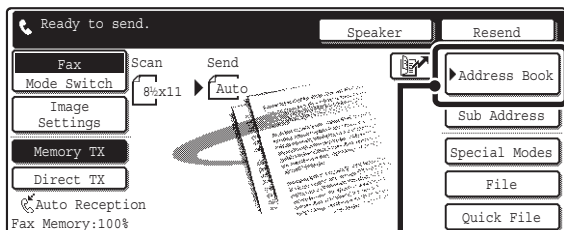

(1)

## Enter the destination fax number.

(1) Touch the [Address Book] key.

(2) Touch the one-touch key of the desired destination.

Touch the one-touch key in which the fax number and F-code of the relay machine are stored.

(3) Touch the [To] key.

[CALLING UP A FAX NUMBER FROM THE ADDRESS BOOK](#) (page 36)

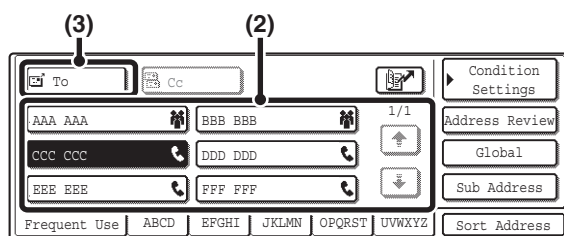

If the fax number of the transmitting machine is not stored in a one-touch key in the Address Book, enter the fax number and F-code with the numeric keys.

(1) Enter the fax number of the destination.

(2) Touch the [Sub Address] key to enter "/".

(3) Enter the sub-address.

(4) Touch the [Sub Address] key to enter "/".

(5) Enter the passcode.

3



## Press the [BLACK & WHITE START] key (○●).

Scanning begins.

- If you inserted the original pages in the document feeder tray, all pages are scanned.  
A beep will sound to indicate that scanning is finished.
- If you are scanning the original on the document glass, scan each page one page at a time. When scanning finishes, place the next original and press the [BLACK & WHITE START] key (○●). Repeat until all pages have been scanned and then press the [Read-End] key.  
A beep will sound to indicate that scanning is finished.

When the relay machine receives the fax, it will automatically transmit the fax to each of the end receiving machines programmed in the memory box.



# RELAY BROADCAST TRANSMISSION USING F-CODES

When your machine receives an F-code relay request transmission, the fax is received to an F-code memory box (relay broadcast) in your machine.

Your machine then relays the fax to each of the end receiving machines programmed in the memory box. Transmission to the end receiving machines takes place automatically.

The fax is transmitted to each of the end receiving machines programmed in the F-code relay broadcast memory box.

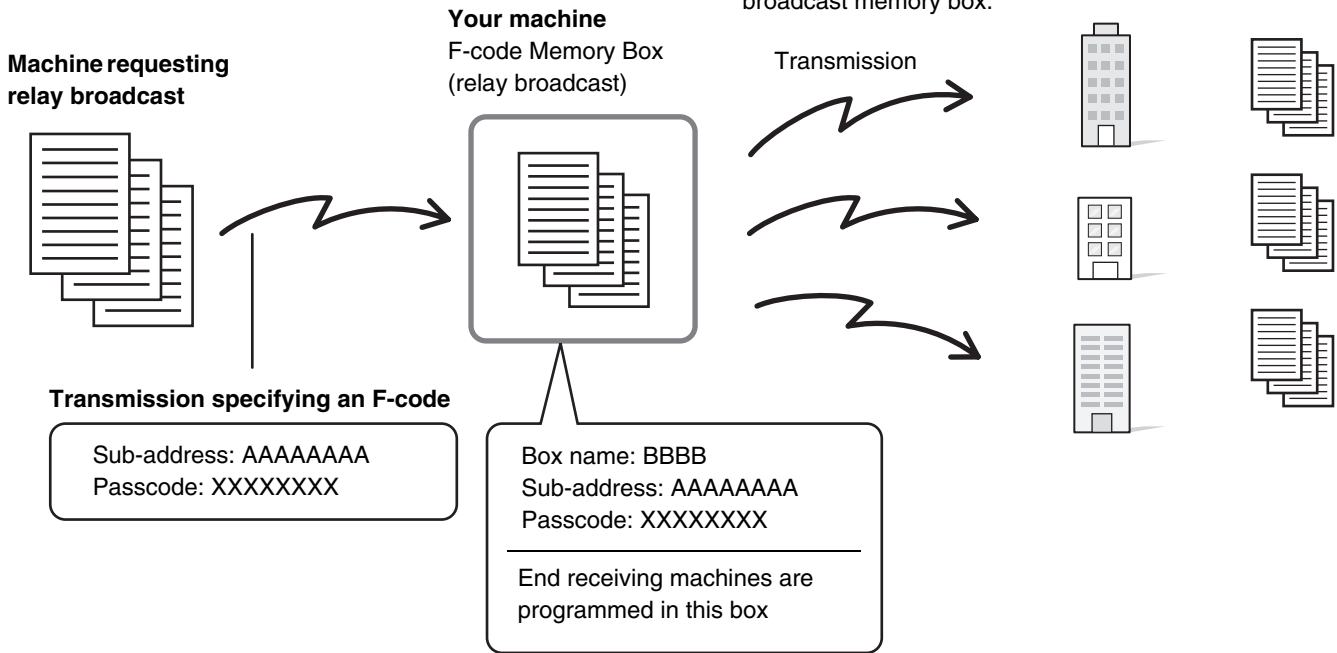

- Prior to the operation, inform the requesting party of the sub-address and passcode of the memory box (relay broadcast) in your machine.
- The end receiving machines are programmed in the F-code relay broadcast memory box when the box is created in your machine.
- The end receiving machines do not need to support F-code communication.
- The other machine (the machine that requests a relay broadcast transmission) only bears the cost of sending the fax to your machine (the relay machine). Your machine (the relay machine) bears the cost of sending the fax to each of the end receiving machines.

# 9

## USING AN EXTENSION PHONE

### CONNECTING AND USING AN EXISTING PHONE (Extension phone connection)

You can connect an existing extension phone to the machine.

The phone can be used for voice calls and to start fax reception on the machine.

As an example, you can make a phone call using the existing phone, speak to the other party, and then press the [BLACK & WHITE START] key (○●) to fax an original that has been placed to that party. You can also press the [BLACK & WHITE START] key (○●) when an original is not placed to receive a fax.

Connect the extension phone as shown below.

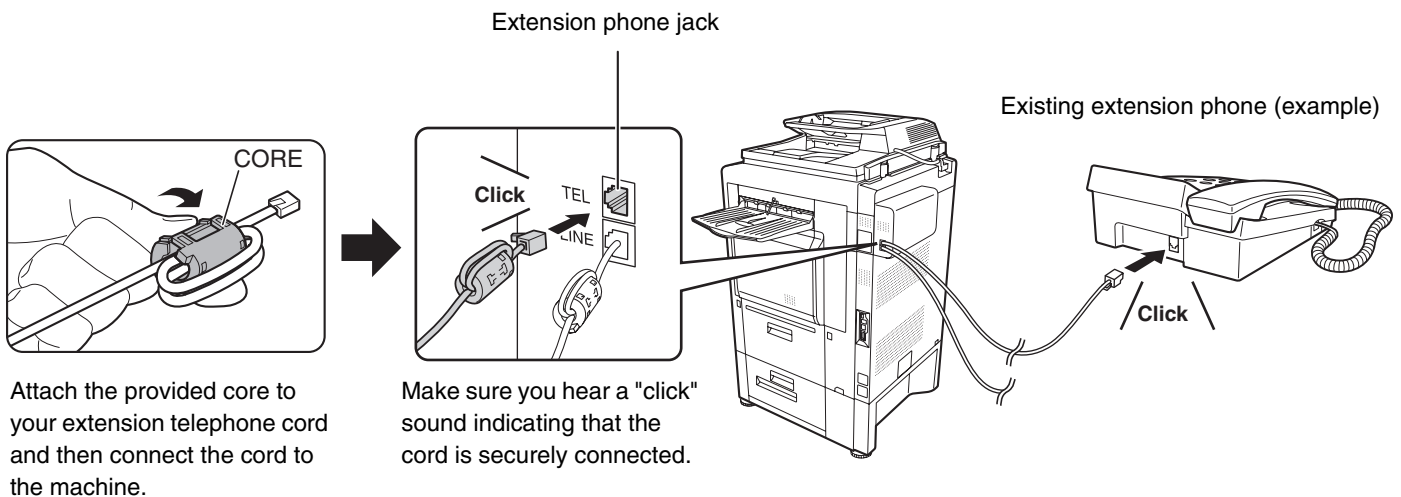

Attach the provided core to your extension telephone cord and then connect the cord to the machine.

Make sure you hear a "click" sound indicating that the cord is securely connected.

- Fax transmission cannot be started from the extension phone.
- Connect an extension phone that has a modular jack. Use standard phone line cable to connect the phone. If other than a standard phone line cable is used, the connection may not work correctly.
- If the plug on the telephone line cord does not fit into the jack on your extension phone, contact your dealer or nearest SHARP Service Department.

# RECEIVING A FAX AFTER ANSWERING A CALL ON THE EXTENSION PHONE (Remote reception)

Follow the steps below if you need to start fax reception after answering a call and speaking on the extension phone. If you are on a pulse-dial (rotary) line, set the extension phone to issue tone signals.

1

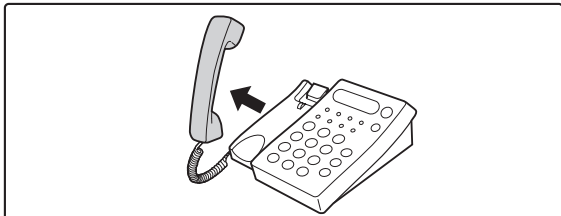

**When you hear ringing, answer the call on the extension phone.**

2

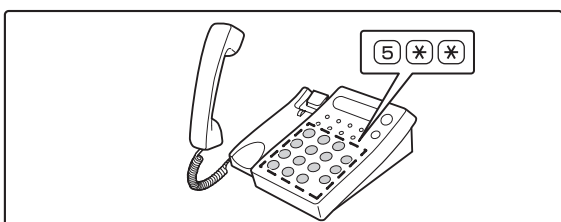

**Signal the machine to start fax reception.**

Press **5 \* \*** on the keypad of the extension phone.

3

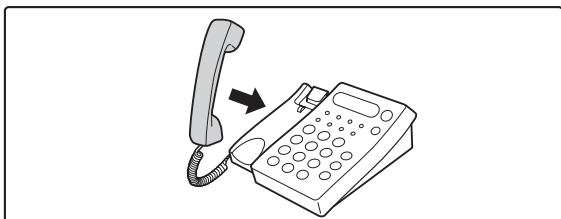

**Replace the extension phone.**

The machine sounds a beep when reception ends.



- **System Settings for Fax: Fax Receive Settings**

To use remote fax reception, set this setting to "Manual Reception".

➔ [Fax Receive Settings](#) (page 160)

- **System Settings for Fax (Administrator): Remote Reception Number Setting** (page 179)

This is used to change the number used for remote fax reception. The factory default setting is "5".

## MAKING AND RECEIVING PHONE CALLS

You can make and receive calls like normal on your extension phone.

# 10

## IF THE MACHINE IS MOVED

This chapter explains connections and changes to settings that are necessary in the event that the machine is moved.

---

---

### CONNECTIONS AND SETTINGS AFTER THE MACHINE IS MOVED

If the machine is moved to a different location or the fax number changes, check the following items and change the following settings:

Telephone line connection, telephone line type setting, check the main power, check the date and time, change your sender fax number setting.

#### CONNECTION TO THE TELEPHONE LINE

Be sure to use the provided telephone line cord to connect the machine to the wall telephone jack. When connecting the telephone line cord, insert the end of the cord with the core into the jack (LINE) on the machine. Insert the other end (with no core) into the wall telephone jack.

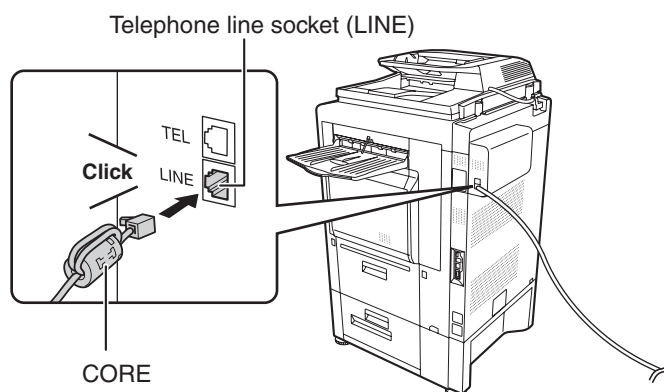

Insert the end of the cord into the telephone line socket (LINE).

# SETTING THE TELEPHONE LINE TYPE

The machine's dial mode setting must be set to the type of telephone line you are using.

If the setting is not correct, dialing will not be possible.

Make sure that "Dial Mode Setting" is set to "Auto Select" in the system settings for fax (administrator).

The machine will automatically set the dial mode to the type of line you are using.

Your telephone line type can also be set manually.

System Settings for Fax (Administrator) : [Dial Mode Setting](#) (page 178)



After setting the dial mode, do not change the setting unless you have a specific reason for changing it.



# MAKING SURE THAT THE MAIN POWER IS ON

The main power is "On" when the main power indicator on the operation panel is lit.

If the main power indicator light is not lit, the main power is off. Switch the main power switch to the "On" position and press the [POWER] key (  ) on the operation panel.

If the fax function will be used, and in particular if reception or timer transmission will take place at night, always keep the main power switch in the "On" position.



When the [POWER SAVE] key (  ) indicator light is blinking, the machine is in auto power shut-off mode. If the [POWER SAVE] key (  ) is pressed when the indicator is on, the indicator will turn off and the machine will return to the ready state after a brief interval.

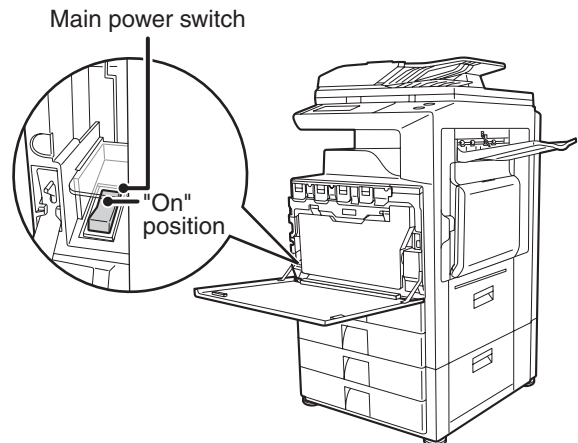
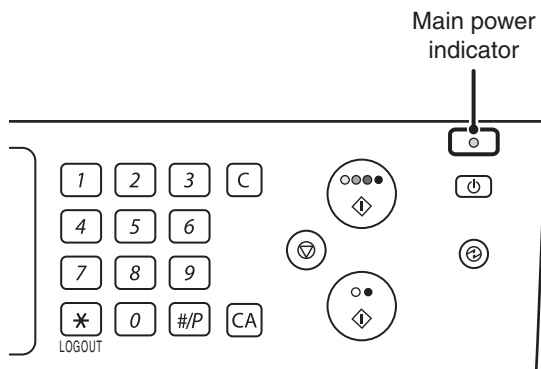

# CHANGING THE SENDER FAX NUMBER

If your fax number changed, change the sender fax number.



System Settings for Fax (Administrator): [Fax Own Name and Number Set](#) (page 178)

This is used to change the sender fax number.

# CHECKING THE DATE AND TIME

To check if the date and time are set correctly in the machine, follow the steps below.

1



Press the [SYSTEM SETTINGS] key.

2

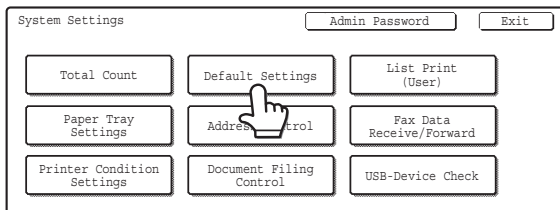

Touch the [Default Settings] key.

3

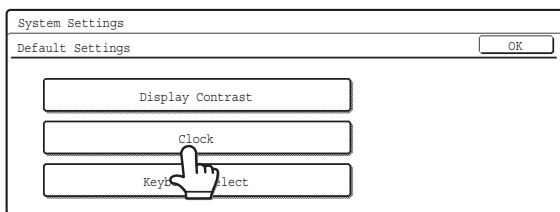

Touch the [Clock] key.

4



To change the format of the date, touch the [Date Format] key. The following screen will appear.

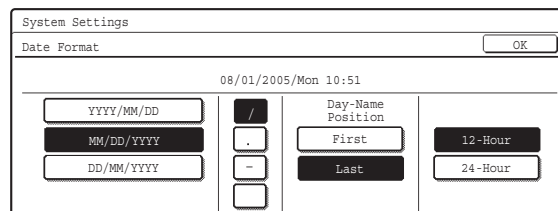

In the date format screen, select the order of the year, month, and date (MM/DD/YYYY), the separator character, the position of the day, and 12-hour or 24-hour format. Select each item and touch the [OK] key.

If you want the clock to change automatically at the beginning and end of daylight saving time, select the [Daylight Saving Time Setting] checkbox .

When this function is used, the time changes at the beginning and end of daylight saving time as follows:

Standard time → Daylight saving time: First Sunday in April, 2:00 → 3:00 AM

Daylight saving time → Standard time: Last Sunday in October, 2:00 → 1:00 AM

If "Disabling of Clock Adjustment" has been enabled in the system settings (administrator), the date and time cannot be set.

This chapter explains System Settings that are related to fax mode. For information on other system settings, see the System Settings Guide.

## System Settings

The system settings are used to configure a variety of parameters to suit the aims and the needs of your workplace. The system settings are also used to display or print out the current settings and status of the machine. The system settings allow you to make the machine easier to use.

The system settings consist of settings for use by general users, and settings that can only be configured by an administrator of the machine. These two groups of settings are distinguished in this manual as follows.

System Settings (General)	System Settings (Administrator) *Login Required
<p>System settings that can be configured by general users (including the administrator). For example, the following settings can be configured.</p> <ul style="list-style-type: none"> <li>• Storing destinations for fax.</li> <li>• Displaying the number of pages faxed.</li> </ul>	<p>System settings that can be configured by the administrator. To configure these settings, login as an administrator is required. For example, the following settings can be configured.</p> <ul style="list-style-type: none"> <li>• Settings for peripheral devices installed on the machine.</li> <li>• Transmission/reception settings for fax</li> </ul>
<b>Settings for general users</b>	<b>Settings for administrators</b>



- **Administrator password**

To maintain security, the administrator of the machine should promptly change the password after the machine is purchased. (For the factory default administrator password, see "TO THE ADMINISTRATOR OF THE MACHINE" in the Safety Guide.) To change the password, see "Change Administrator Password" in the System Settings Guide.

\*To ensure a high level of security, change the password at regular intervals.

- The above groupings of "General" and "Administrator" are used as a convenient means of clarifying the functions of the settings. These groupings do not appear in the touch panel.
- To configure the system settings from the Web pages, click [System Settings] in the Web page menu.

---

---

# Accessing the System Settings (General)

## When User Authentication is not Enabled

Make sure that the machine is in the standby state and then press the [SYSTEM SETTINGS] key on the operation panel.

### Operation panel

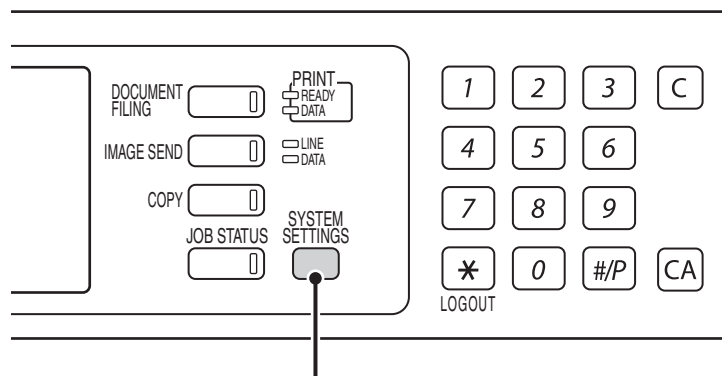

[SYSTEM SETTINGS] key

When the [SYSTEM SETTINGS] key is pressed, the following menu screen appears on the touch panel. Touch the item in this screen that you wish to configure. For detailed explanations of each of the settings, see the following pages of this chapter.

### System settings screen (factory default state)

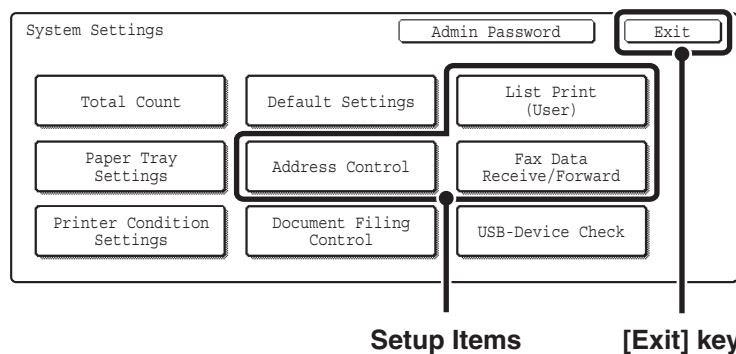

Setup Items

[Exit] key



- To quit the system settings, touch the [Exit] key in the top right corner of the screen.
- User authentication is initially disabled (factory default setting).



# When User Authentication is Enabled

When "User Authentication Setting" is enabled, login is required in the login screen before the machine can be used. The login screen varies depending on the settings configured in "Authentication Method Setting". If one of the following login screens appears, log in using the user information provided by the administrator of the machine. You can then use the system settings.

For more information, see the System Settings Guide.

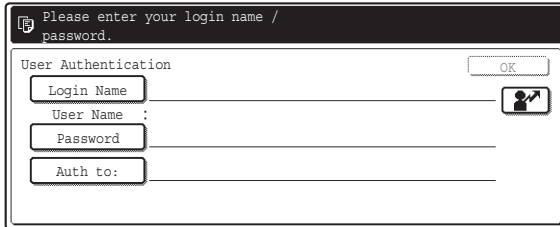

**Login name and password**

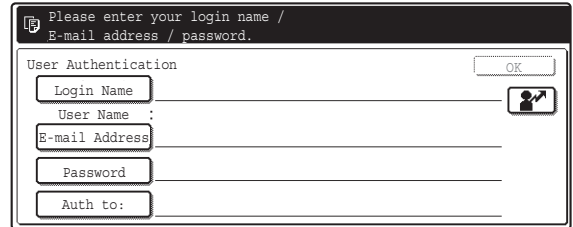

**Login name, password and E-mail address**

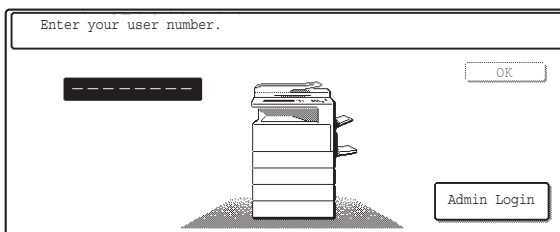

**User number**



- Check with your administrator for the user information that is required to log in.
- When auto login is enabled, the login screen will not appear.
- For the procedure for entering text, see "6. ENTERING TEXT" in the User's Guide.

## Login by login name and password

When authentication is by login name/password/e-mail address, your e-mail address must also be entered in the following procedure. Touch the [E-mail Address] key and enter your e-mail address, which is stored on the LDAP server, in same way as you entered the password. When finished, touch the [OK] key.

1

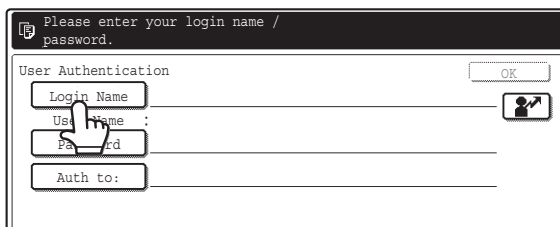

**Touch the [Login Name] key.**



You can touch the  key and enter a user registration number with the numeric keys to directly select the corresponding user.

2

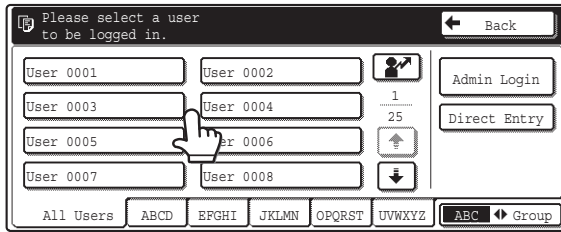

### Select the user.



- You can touch the  key and enter a user registration number with the numeric keys to directly select the corresponding user.
- To specify a user not stored in the machine directly using the LDAP server, touch the [Direct Entry] key, enter the login name that is stored on the LDAP server, and touch the [OK] key. (When LDAP is enabled.)

3

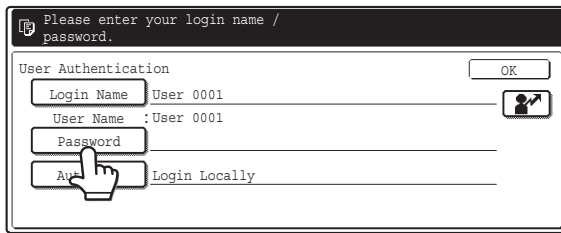

### Enter a password.

- (1) Touch the [Password] key.
- (2) Enter a password on the text entry screen that will appear.

When logging in locally to the machine, enter your password that was stored when user information is registered.

If authentication is to the LDAP server, enter your password that is stored on the LDAP server.

For the procedure for entering text, see "6. ENTERING TEXT" in the User's Guide.



- If a password has not been established, this step is not necessary. Go to step 4.

4

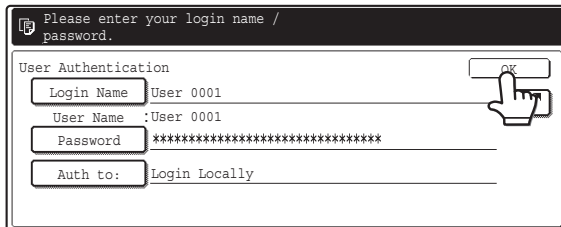

### Touch the [OK] key.



- When a user is selected that is stored on the machine, [Auth to:] is entered. To enter your login name directly or change the login destination, touch the [Auth to:] key. The following screen appears when the key is touched. Select the desired key and touch the [OK] key.

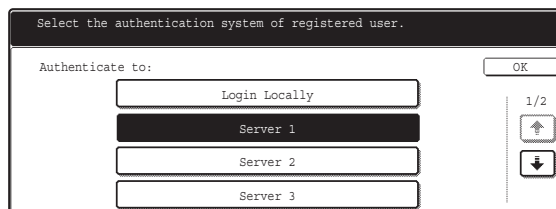

- "Authenticate to" cannot be changed when an LDAP server has not been stored.
- Users for which the authentication destination is LDAP cannot select "Login Locally".
- This completes the login procedure. After login, the system settings can be used. For the procedure following login, see "[When User Authentication is not Enabled](#)" (page 128).

# Login by user number

1

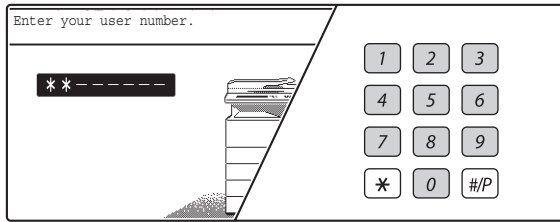

## Enter your user number with the numeric keys.

Each entered digit will be displayed as "\*" .

2

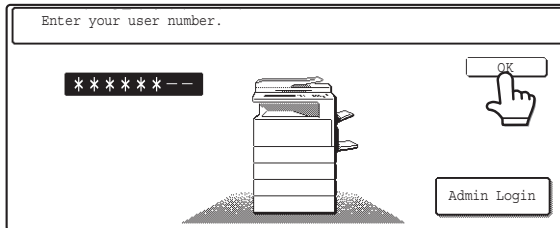

## Touch the [OK] key.



- When an user number is set to a 8-digit number, this step is not necessary. (When an user number is entered, login will take place automatically.)
- This completes the login procedure. After login, the system settings can be used.  
For the procedure following login, see "[When User Authentication is not Enabled](#)" (page 128).



- To configure and store LDAP settings, click [Network Settings] and then [LDAP Settings] in the Web page menu. (Administrator rights are required.)
- When Auto Clear activates, logout automatically takes place.
- **To logout...**  
Press the [LOGOUT] key (). (Except when entering a fax number.)

# System Settings (General) List

When the system settings are accessed with general rights, the following items appear. The factory default settings for each item are also shown. For items that can only be accessed with administrator rights, see "[System Settings \(Administrator\) List](#)" (page 165).

 Depending on the machine specifications and peripheral devices installed, it may not be possible to use some settings.

Item	Factory default setting	Page
■ <b>List Print (User)</b>		134
● <b>Sending Address List</b>		134
▶ Individual List	–	
▶ Group List	–	
▶ Program List	–	
▶ Memory Box List	–	
▶ All Sending Address List	–	
■ <b>Address Control</b>		135
● <b>Direct Address/Program</b>		135
▶ Individual		
◆ Fax		
• Search Number	–	
• Name	–	
• Initial	–	
• Index	–	
• Fax No.	–	
• Key Name	–	
• Mode	–	
▶ Group		
◆ Search Number	–	
◆ Group Name	–	
◆ Initial	–	
◆ Index	–	
◆ Address	–	
◆ Key Name	–	
		140

Item	Factory default setting	Page
▶ Program		
◆ Program Name	–	
◆ Settings		
• Address	–	144
• Resolution	–	
• Exposure	–	
• Special Modes	–	
▶ Modify / Delete	–	146
● F-Code Memory Box		
▶ Store		
◆ Polling Memory		
• Box Name	–	149
• Sub Address	–	
◆ Confidential		
• Box Name	–	151
• Sub Address	–	
• Print PIN	–	
◆ Relay Broadcast		
• Box Name	–	154
• Sub Address	–	
• Recipient	–	
▶ Modify/Delete		
◆ Polling Memory	–	157
◆ Confidential	–	
◆ Relay Broadcast	–	
● Custom Index		
▶ User 1	–	159
▶ User 2	–	
▶ User 3	–	
▶ User 4	–	
▶ User 5	–	
▶ User 6	–	
■ Fax Data Receive/Forward		160
● Fax Receive Settings	Auto Reception	160
● Fax Data Forward*	–	

\* See "FORWARDING RECEIVED FAXES (Fax Data Forward)" (page 101).

---

---

# List Print (User)

A test page can be printed to check the machine settings.

## Sending Address List

Use this to print the Individual List, the Group List, the Program List, the Memory Box List, and the All Sending Address List.

1



Press the [SYSTEM SETTINGS] key.

2

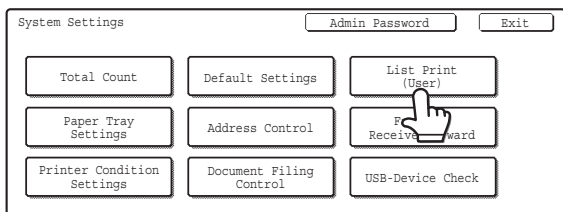

Touch the [List Print (User)] key.

3

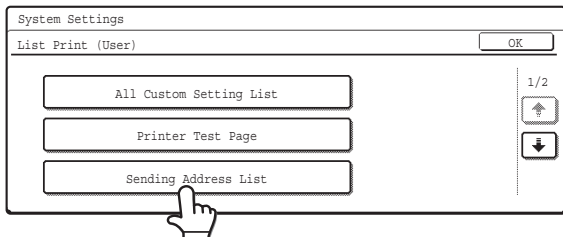

Touch the [Sending Address List] key.

4

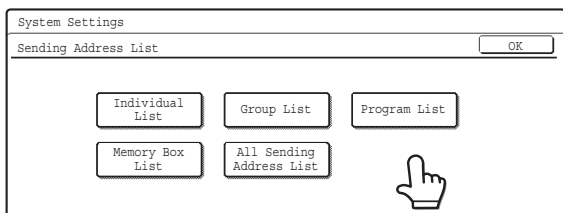

Touch the list that you wish to print.

A message screen appears and printing begins.



### To cancel printing...

Touch the [Cancel] key in the message screen that appears after you touch one of the keys.

---

---

# Address Control

## Storing a One-touch (Individual) Key for Fax

The fax number and name of a fax destination can be stored in a one-touch key. This will allow the fax number to be entered by simply touching the key.

- For the procedure for entering text, see "6. ENTERING TEXT" in the User's Guide.
- One-touch keys can also be stored in the Web pages. Click [Address Book] in the Web page menu, and click the [Add] button that appears. Select [Fax] in [Address Type] and then store the address.

1



Press the [SYSTEM SETTINGS] key.

2

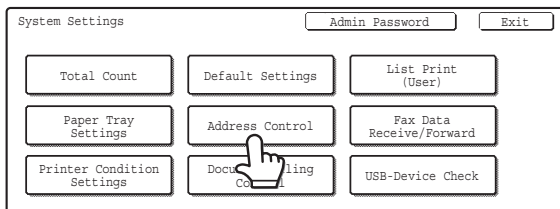

Touch the [Address Control] key.

3

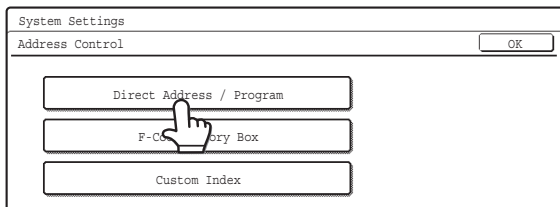

Touch the [Direct Address / Program] key.

4

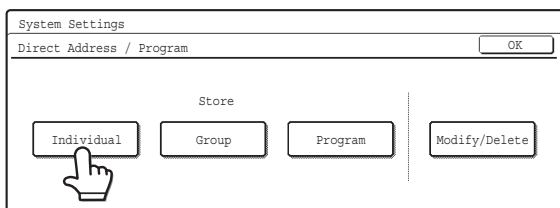

Touch the [Individual] key.

5

Direct Address / Individual      Next      Exit

E-mail     Internet Fax     Fax

Search Number    001

Name

Initial                      Index

Fax No.

1/2

↑

↓

**Make sure that the [Fax] checkbox is selected .**

If a checkmark  does not appear, touch the [Fax] checkbox.



The lowest number not yet used is automatically entered as the [Search Number].

If you wish to change the search number, touch the [Search Number] key and enter a 3-digit number with the numeric keys.

6

Direct Address / Individual      Next      Exit

E-mail     Internet Fax     Fax

Search Number    001

Name

Initial                      Index

Fax No.

1/2

↑

↓

**Enter the destination name.**

**(1) Touch the [Name] key.**

**(2) Enter the destination name on the text entry screen that will appear.**

Enter up to 36 characters for the name.

For the procedure for entering text, see "6. ENTERING TEXT" in the User's Guide.

7

Direct Address / Individual      Next      Exit

E-mail     Internet Fax     Fax

Search Number    001

Name    AAA AAA

Initial                      Index

Fax No.

1/2

↑

↓

**Enter initials.**

**(1) Touch the [Initial] key.**

**(2) Enter initials on the text entry screen that will appear.**

Enter up to 5 characters.

For the procedure for entering text, see "6. ENTERING TEXT" in the User's Guide.



The initials you enter here determine the position of the one-touch key in the ABC index.

8

Direct Address / Individual      Next      Exit

E-mail     Internet Fax     Fax

Search Number    001

Name    AAA AAA

Initial    A                      Index

Fax No.

1/2

↑

↓

**Touch the [Index] key.**



9

## Select the index.

(1) Touch the key of the desired index.

(2) Touch the [OK] key.



- One of the upper row of keys, [User 1] to [User 6] (the names can be changed), can be selected to have the one-touch key appear in that index when the custom index display is selected instead of the ABC index display.
- The lower keys are for selecting whether or not to include the group in the [Frequent Use] index. It is convenient to include frequently used destinations in the [Frequent Use] index.

10

## Touch the [Fax No.] key.

11

## Enter the destination fax number.

(1) Enter the destination fax number with the numeric keys.

(2) Touch the [OK] key.



- **Entering a pause between digits of the number...**  
Touch the [Pause] key at the place where you wish to enter a pause. The entered pause appears as a hyphen "-".
- **To enter an F-code (sub-address and passcode)...**
  - (1) Enter the destination fax number with the numeric keys.
  - (2) Touch the [Sub Address] key.  
"/" appears.
  - (3) Enter the sub address with the numeric keys (maximum of 20 digits).
  - (4) Touch the [Sub Address] key.  
"/" appears.
  - (5) Enter the passcode with the numeric keys (maximum of 20 digits).  
A passcode is not necessary if the destination machine does not use a passcode.
- The destination fax number can be a maximum of 64 digits including all numbers and characters. However, only the first 32 digits will appear in the display.
- When (2) is performed, the number entered to that point is stored and "Registration is completed." will appear.



### If an incorrect entry is made...

Press the [CLEAR] key (C) and enter the correct digits.

12

Touch the keys to switch through the screens.

13

### Check the name of the key .

The name appearing next to the [Key Name] key will be displayed in the one-touch key.

To change the key name, touch the [Key Name] key, edit the name, and then touch the [OK] key.



Up to 18 characters can be entered for the key name.

14

(1)

(2)

(3)

(4)

### Check the International Correspondence Mode.

The setting is displayed next to the [Mode] key. To change the setting, follow these steps:

- (1) Touch the [Mode] key.
- (2) Touch one of the transmission speed keys.
- (3) Touch one of the International Correspondence Mode keys.
- (4) Touch the [OK] key.



#### • Transmission speed

33.6kbps, 14.4kbps, 9.6kbps or 4.8kbps can be selected for the transmission speed. Higher numbers are higher transmission speeds.

Set the transmission speed only when you know what speed is most suitable, such as when you are sending a fax to a foreign country and telephone line conditions are bad. If you do not know the line conditions, do not change this setting.

#### • International Correspondence Mode

None, Mode 1, Mode 2, or Mode 3 can be selected for the International Correspondence Mode.

When sending a fax to a foreign country, telephone line conditions can sometimes distort the fax or interrupt the transmission. If errors frequently occur when sending a fax to a foreign country, try each of modes 1 to 3 and select the mode that enables the best transmission.

Direct Address / Individual Next Exit

E-mail  Internet Fax  Fax 

---

Search Number 001 Registration is completed.

Key Name AAA AAA 2/2

Mode 33.6 kbps/None

Touch the [Exit] key.



**If you wish to store another destination...**

Touch the [Next] key and repeat the procedure from step 6.

# Storing a Group Key

Multiple addresses can be stored as a group for a broadcast transmission.

- For the procedure for entering text, see "6. ENTERING TEXT" in the User's Guide.
- Group key can also be stored in the Web pages. Click [Address Book] in the Web page menu, and click the [Add] button that appears. Select [Group] in [Address Type] and then store the address.

1



Press the [SYSTEM SETTINGS] key.

2

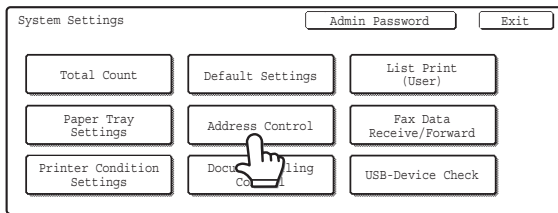

Touch the [Address Control] key.

3

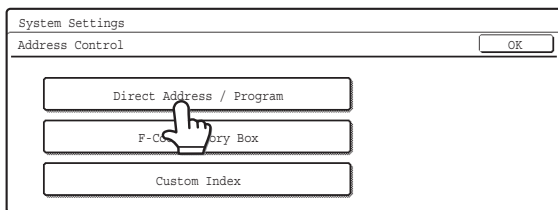

Touch the [Direct Address / Program] key.

4

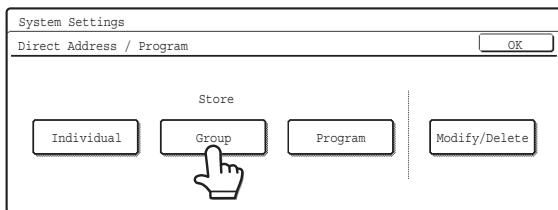

Touch the [Group] key.

5

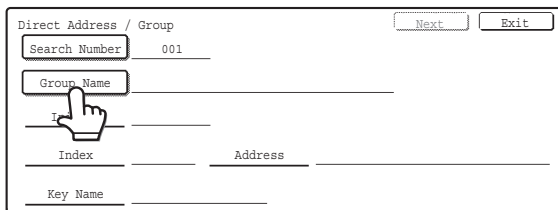

Enter a name for the group.

- (1) Touch the [Group Name] key.
- (2) Enter a name for the group on the text entry screen that will appear.

Enter up to 36 characters for the name.

For the procedure for entering text, see "6. ENTERING TEXT" in the User's Guide.



The lowest number not yet used is automatically entered as the [Search Number]. If you wish to change the search number, touch the [Search Number] key and enter a 3-digit number with the numeric keys. A search number that has already been stored cannot be used.

6

Direct Address / Group Next Exit

Search Number 001

Group Name BBB BBB

Initial \_\_\_\_\_

Address \_\_\_\_\_

Key Name \_\_\_\_\_

### Enter initials.

- (1) Touch the [Initial] key.
- (2) Enter initials on the text entry screen that will appear.

Up to 10 characters can be entered.

For the procedure for entering text, see "6. ENTERING TEXT" in the User's Guide.



The initials you enter here determine the position of the one-touch key in the ABC index.

7

Direct Address / Group Next Exit

Search Number 001

Group Name BBB BBB

Initial B

Index \_\_\_\_\_

Address \_\_\_\_\_

Key Name \_\_\_\_\_

### Touch the [Index] key.

8

Direct Address / Group Next Exit

No.001

Index

Select the custom index where you register this address.

User 1 User 2 User 3 User 4 User 5 User 6

Do you register this address at the [Frequent Use], too?

Yes No

### Select the index.

- (1) Touch the key of the desired index.
- (2) Touch the [OK] key.



- One of the upper row of keys, [User 1] to [User 6] (the names can be changed) can be selected to have the group appear in that index when the custom index display is selected instead of the ABC index display.
- The lower keys are for selecting whether or not to include the group in the [Frequent Use] index. It is convenient to include frequently used addresses and groups in the [Frequent Use] index.

9

Direct Address / Group Next Exit

Search Number 001

Group Name BBB BBB

Initial B

Index User 1

Address \_\_\_\_\_

Key Name \_\_\_\_\_

### Touch the [Address] key.

10

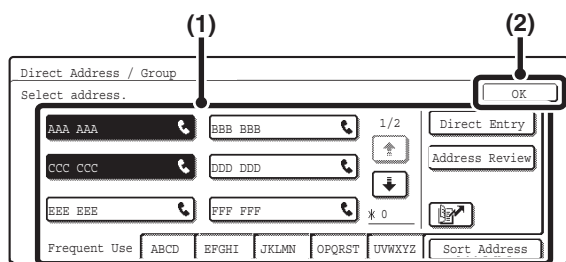

## Select the desired destination.

### (1) Touch the keys of the desired destinations.

The selected destinations are highlighted and stored in the group key.

### (2) Touch the [OK] key.



- Touch the [OK] key. "Registration is completed." will appear.
- Keys that cannot be stored as group keys are grayed out to prevent selection.
- To directly enter a destination fax number or check the selected destinations, see "[Direct entry](#)" (page 143) and "[Checking addresses](#)" (page 143).
- Up to 500 destinations can be stored.



### If an incorrect destination is selected...

Touch the destination once again so that it is not highlighted. This removes it from the group being stored.

11

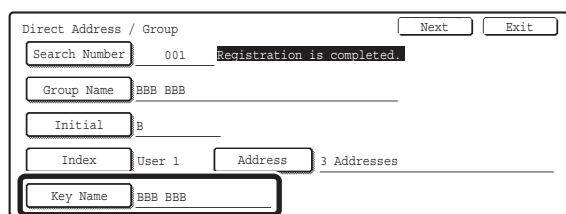

## Check the key name.

If you need to change the name that appears in the key, touch the [Key Name] key and enter the desired name (maximum of 18 characters).



- The characters appearing next to the [Key Name] key will be displayed in the group key. Initially the first 18 characters of the group name entered in step 6 appear.

12

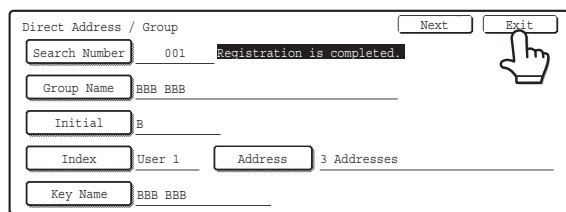

## Touch the [Exit] key.



### To store another group...

Touch the [Next] key and repeat the procedure from step 5.



- A total of 999 one-touch keys and group keys can be stored.
- It will not be possible to store a group if this has been prohibited using "[Disable Registering Destination from Operation Panel](#)" (page 177) in the system settings for fax (administrator).

## Direct entry

Direct Address / Group  
Select address. OK

AAA AAA E-mail Direct Entry  
BBB BBB I-Fax Address Review  
CCC CCC Fax

Frequent Use ABCD EFGHI JKLMN OPQRST UVWXYZ Sort Address

- To enter a destination that is not stored in a one-touch key, touch the [Direct Entry] key, touch the [Fax] key, and enter the fax number.

## Checking addresses

Direct Address / Group  
Select address to delete. OK

Group Name : OK  
001 AAA AAA 002 BBB BBB 1/1  
003 CCC CCC

- To check the destinations that have been selected, touch the [Address Review] key in the address selection screen. The selected destinations are displayed.
- To deselect a destination from the group, touch the displayed destination.  
A message will appear to confirm the deletion. Touch the [Yes] key.

 If "Disable Direct Entry" (page 188) has been enabled in the system settings for fax (administrator), it will not be possible to directly enter a destination fax number.

# Storing a Program

If you frequently use the same settings and/or functions to transmit to the same destination or destinations, the settings and destinations can be stored in a program. This allows the settings and destinations to be selected by simply selecting the program.

- For the procedure for entering text, see "6. ENTERING TEXT" in the User's Guide.
- The following settings can be stored in programs.  
Destinations: One-touch keys, group keys, search numbers  
Image settings: Resolution, Exposure  
Special modes: Polling reception, Erase, Dual Page Scan, 2in1.  
F-code communication: A destination that includes an F-code can be stored to perform an F-code operation.  
For more information, see "[STORING FAX OPERATIONS \(Programs\)](#)" (page 81)
- Program can also be stored in the Web pages. Click [Job program] and then [Program Registration] in the Web page menu.

1



Press the [SYSTEM SETTINGS] key.

2

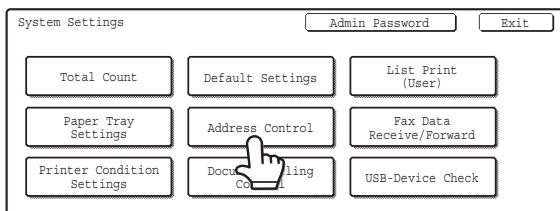

Touch the [Address Control] key.

3

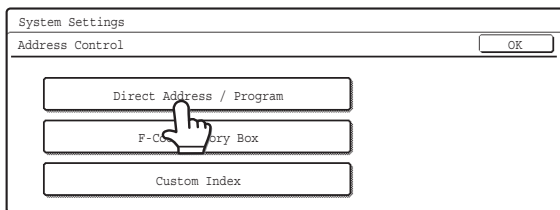

Touch the [Direct Address / Program] key.

4

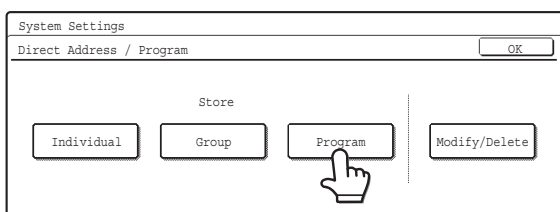

Touch the [Program] key.

5

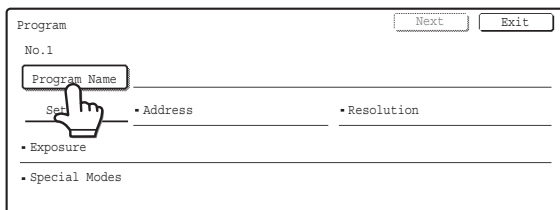

Enter a program name.

(1) Touch the [Program Name] key.

(2) Enter a program name on the text entry screen that will appear.

Enter up to 18 characters for the name.  
For the procedure for entering text, see "6. ENTERING TEXT" in the User's Guide.

- The program number that automatically appears is the lowest number from 1 to 48 that has not yet been programmed. (This number cannot be selected from the numbers that have not been programmed.)



6

Program Next Exit

No.1

Program Name CCC CCC

Settings \*Address \*Resolution

\*Exposure

\*Special Modes

**Touch the [Settings] key.**

7

Enter program you require. Cancel OK

Fax

Mode Switch

Image Settings

Address Book

Address Review

Special Modes

(1) (2)

**Select settings for the program.**

**(1) Select the destinations and settings that you wish to include in the program.**

For the procedures for storing destinations and settings, see the following pages:

Destinations (page 36), Resolution (page 28), Exposure (page 29)

Special modes

Polling Reception (page 92), Erase (page 69),

Dual Page Scan (page 72), 2in1 (page 75)

**(2) Touch the [OK] key.**



**To change to another mode...**

Touch the [Mode Switch] key and then the key of the mode that you wish to store in the program.

8

Program Next Exit

No.1 **Registration is completed.**

Program Name CCC CCC

Settings \*Address :4 Addresses \*Resolution :Standard

\*Exposure :1 : 5 Text

\*Special Modes :Erase

**Touch the [Exit] key.**



**To store another program...**

Touch the [Next] key and repeat the procedure from step 5.



- A timer setting cannot be included in a program.
- At least one one-touch key must be specified in a program or the program cannot be stored.
- Up to 48 programs can be stored.

# Modify/Delete a One-touch Key or Program

Follow the steps below to edit or delete a one-touch key, group, or program.



For the procedure for entering text, see "6. ENTERING TEXT" in the User's Guide.

1



Press the [SYSTEM SETTINGS] key.

2

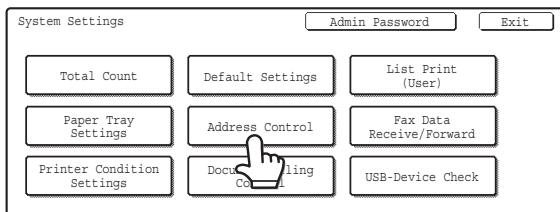

Touch the [Address Control] key.

3

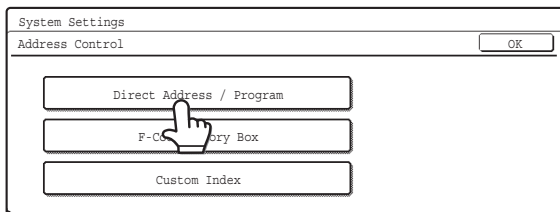

Touch the [Direct Address / Program] key.

4

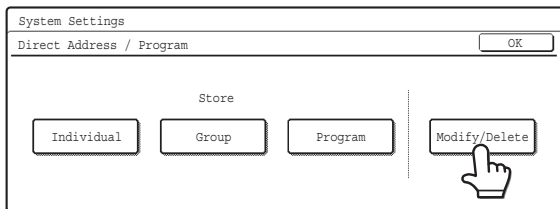

Touch the [Modify/Delete] key.



If no keys have been stored, the [Modify/Delete] key cannot be selected.

5

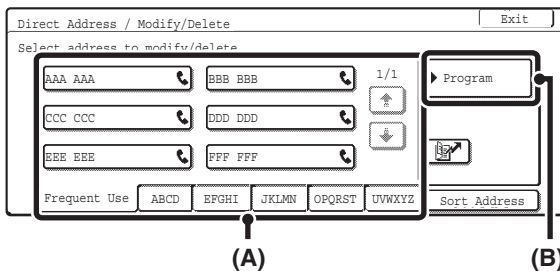

Touch the key that you wish to edit or delete.

- (A) Touch the one-touch key or group key that you wish to edit or delete.
- (B) If you wish to edit or delete a program, touch the [Program] key.

## Edit/Delete

### Individual

Direct Address / Modify/Delete

E-mail  Internet Fax  Fax

Search Number 001

Name AAA AAA

Initial A Index User 1

Fax No. 0123456789

1/2

Delete Exit

### Group

Direct Address / Modify/Delete

Search Number 001

Group Name BBB BBB

Initial B

Index User 1 Address 3 Addresses

Key Name BBB BBB

Delete Exit

### Program

Program

No. 1

Program Name CCC CCC

Settings \*Address :4 Addresses \*Resolution :Standard

\*Exposure :1 · 5 Text

\*Special Modes :Erase

Delete Exit

### ● Editing

(1) Touch the keys of the items that you wish to edit.

Edit the items in the same way as you stored them.

(2) Touch the [Exit] key.

6

### ● Deleting

(1) Touch the [Delete] key.

(2) Touch the [Yes] key.

Direct Address / Modify/Delete

E-mail  Internet Fax  Fax

Search Number 001

Name AAA AAA

Initial A Index User 1

Fax No. 0123456789

1/2

Delete Exit

⚠ Delete the address?

☎ AAA AAA

No Yes



To cancel the deletion...

Touch the [No] key.



### **If you cannot edit or delete a one-touch individual or group key...**

Individual keys and group keys cannot be edited or deleted in the following situations:

- The key is used in a reserved transmission or a transmission that is in progress.
- The key is included in a group key.
- The key is included in a program.
- The key is specified as an end receiving machine in an F-code relay broadcast transmission.
  - [Editing and Deleting F-code Memory Boxes](#) (page 157)
- The key is specified as a forwarding destination as explained in "[FORWARDING A RECEIVED FAX TO AN E-MAIL ADDRESS \(Inbound Routing Settings\)](#)" (page 104).

If the key is used in a reserved transmission or a transmission that is in progress, cancel the transmission or wait until it is completed and then edit or delete the key.

If the key is included in a group, first delete the key from the group and then edit or delete the key.

If the key is specified as a forwarding destination, cancel the forwarding destination setting and then edit or delete the key.

# Programming an F-code Memory Box (Polling Memory)

Follow the steps below to program a memory box for F-code polling memory. The sub-address and passcode that you program in the memory box are necessary for the other machine to poll your machine (request transmission) using F-code communication.

- When programming a new memory box, a sub-address that is already programmed for another box cannot be used. However, the same passcode can be used for more than one memory box.
- A total of 100 F-code memory boxes for all functions (polling memory, confidential, and relay broadcast) can be stored. When 100 memory boxes are stored, no further memory boxes be stored. Delete unnecessary memory boxes and then store a new memory box.
  - [Editing and Deleting F-code Memory Boxes](#) (page 157)
- A passcode does not need to be stored if the other machine does not use a passcode.

1



Press the [SYSTEM SETTINGS] key.

2

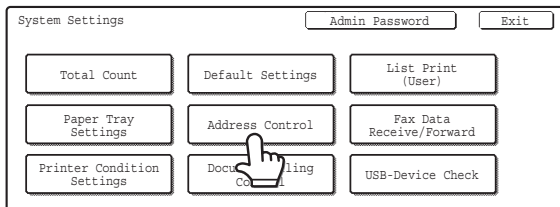

Touch the [Address Control] key.

3

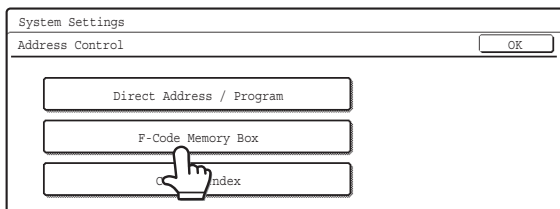

Touch the [F-Code Memory Box] key.

4

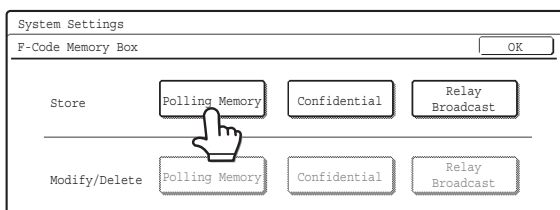

Touch the [Polling Memory] key in the "Store" (upper) row of keys.

5

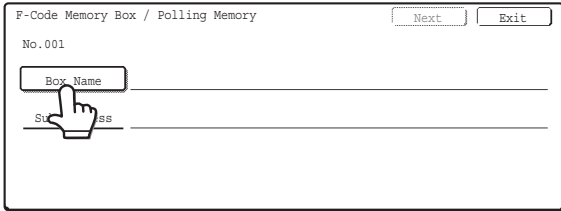

### Enter a box name.

**(1) Touch the [Box Name] key.**

The box number (No.) that automatically appears is the lowest number that has not yet been programmed.

**(2) Enter a box name on the text entry screen that will appear.**

Enter up to 18 characters for the name.

For the procedure for entering text, see "6. ENTERING TEXT" in the User's Guide.

6

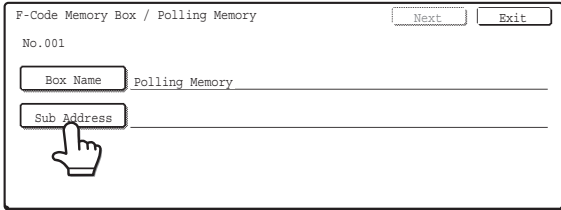

### Touch the [Sub Address] key.

7

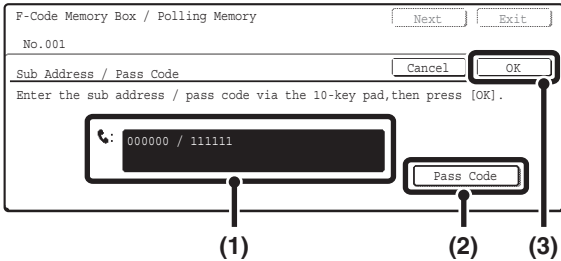

### Enter a sub-address and passcode.

**(1) Enter a sub-address.**

Enter a sub-address with the numeric keys (maximum of 20 digits).

**(2) Enter a passcode.**

Touch the [Pass Code] key and enter a passcode with the numeric keys (maximum of 20 digits).

If you do not need to store a passcode, go to the next step.

**(3) Touch the [OK] key.**



- "\*" and "#" cannot be used in a sub-address.
- When the [Pass Code] key is touched, "/" appears.



**If an incorrect entry is made...**

Press the [CLEAR] key (C) and enter the correct digits.

8

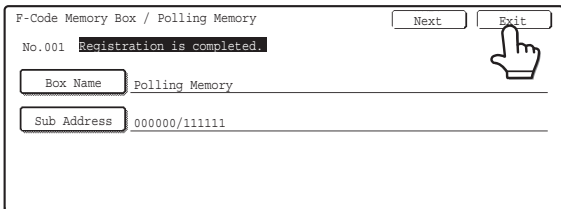

### Touch the [Exit] key.



**To program another memory box...**

Touch the [Next] key and repeat the procedure from step 5.

# Programming an F-code Memory Box (Confidential)

Follow the steps below to program a memory box for F-code confidential reception. The sub-address and passcode that you program in the memory box are necessary for the other machine to send a fax to your machine by F-code confidential transmission. In addition, you will also program a Print PIN in the memory box that will be used to print faxes received by confidential reception.



- When programming a new memory box, a sub-address that is already programmed in another box cannot be used. However, the same passcode can be used for more than one memory box.
- A total of 100 F-code memory boxes for all functions (polling memory, confidential, and relay broadcast) can be stored. When 100 memory boxes are stored, no further memory boxes be stored. Delete unnecessary memory boxes and then store a new memory box.
  - [Editing and Deleting F-code Memory Boxes](#) (page 157)
- A passcode does not need to be stored if the other machine does not use a passcode.

1

SYSTEM  
SETTINGS



Press the [SYSTEM SETTINGS] key.

2

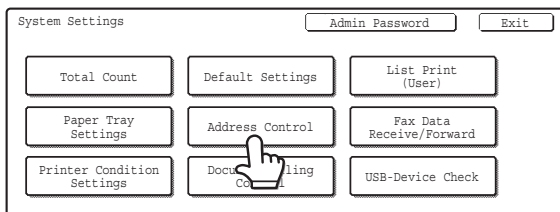

Touch the [Address Control] key.

3

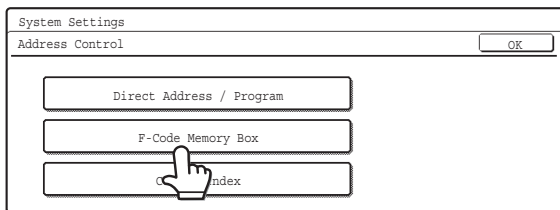

Touch the [F-Code Memory Box] key.

4

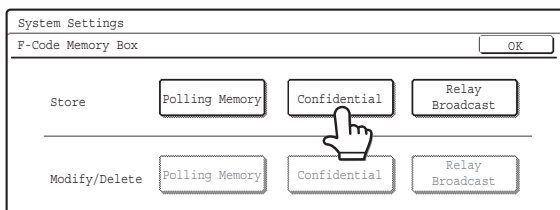

Touch the [Confidential] key in the "Store" (upper) row of keys.

5

### Enter a box name.

**(1) Touch the [Box Name] key.**

The box number (No.) that automatically appears is the lowest number that has not yet been programmed.

**(2) Enter a box name on the text entry screen that will appear.**

Enter up to 18 characters for the name.

For the procedure for entering text, see "6. ENTERING TEXT" in the User's Guide.

6

### Touch the [Sub Address] key.

7

### Enter a sub-address and passcode.

**(1) Enter a sub-address.**

Use the numeric keys to enter a sub-address (maximum of 20 digits).

**(2) Enter a passcode.**

Touch the [Pass Code] key and enter a passcode with the numeric keys (maximum of 20 digits).

If you do not need to store a passcode, go to the next step.

**(3) Touch the [OK] key.**



- "\*" and "#" cannot be used in a sub-address.
- When the [Pass Code] key is touched, "/" appears.



**If an incorrect entry is made...**

Press the [CLEAR] key (C) and enter the correct digits.

8

### Touch the [Print PIN] key.



9

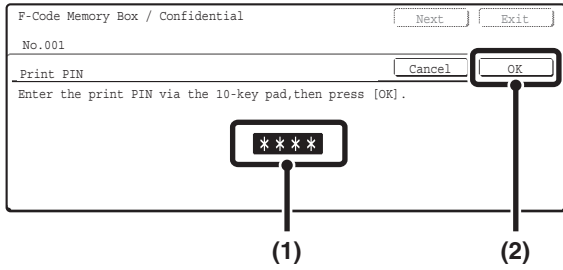

## Specify a Print PIN.

(1) Enter a Print PIN (4 digits) with the numeric keys.

"\*" and "#" cannot be used.

(2) Touch the [OK] key.



Do not forget the Print PIN. In the event that you forget the Print PIN or need to verify the Print PIN, contact your dealer or nearest SHARP Service Department.

10

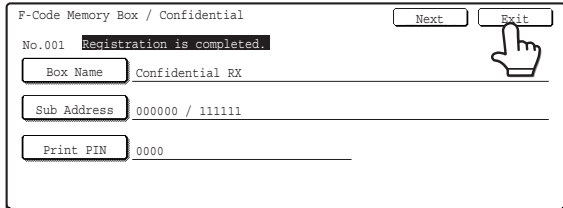

## Touch the [Exit] key.



### To program another memory box...

Touch the [Next] key and repeat the procedure from step 5.

# Programming an F-code Memory Box (Relay Broadcast)

Follow the steps below to program a memory box for F-code relay broadcast transmission. The sub-address and passcode that you program in the memory box will be required when the other machine performs an F-code relay request transmission (asks your machine to relay a fax). In addition, you will also store the fax numbers of the end receiving machines (up to 30) in the memory box.

- When programming a new memory box, a sub-address that is already programmed in another box cannot be used. However, the same passcode can be used for more than one memory box.
- A total of 100 F-code memory boxes for all functions (polling memory, confidential, and relay broadcast) can be stored. When 100 memory boxes are stored, no further memory boxes be stored. Delete unnecessary memory boxes and then store a new memory box.
  - [Editing and Deleting F-code Memory Boxes](#) (page 157)
- A passcode does not need to be stored if the other machine does not use a passcode.

1



Press the [SYSTEM SETTINGS] key.

2

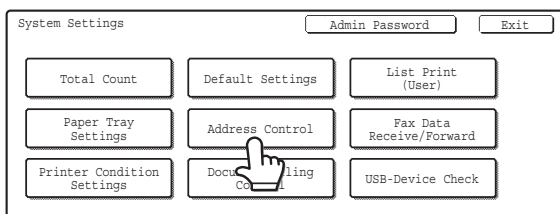

Touch the [Address Control] key.

3

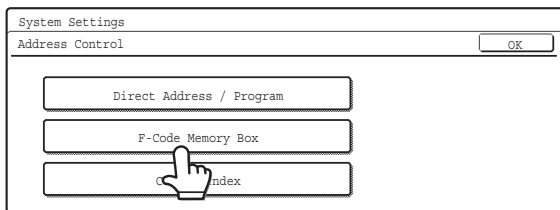

Touch the [F-Code Memory Box] key.

4

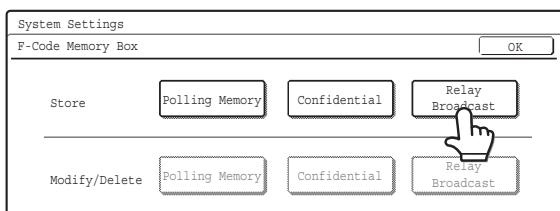

Touch the [Relay Broadcast] key in the "Store" (upper) row of keys.

5

### Enter a box name.

**(1) Touch the [Box Name] key.**

The box number (No.) that automatically appears is the lowest number that has not yet been programmed.

**(2) Enter a box name on the text entry screen that will appear.**

Enter up to 18 characters for the name.

For the procedure for entering text, see "6. ENTERING TEXT" in the User's Guide.

6

### Touch the [Sub Address] key.

7

### Enter a sub-address and passcode.

**(1) Enter a sub-address.**

Use the numeric keys to enter a sub-address (maximum of 20 digits).

**(2) Enter a passcode.**

Touch the [Pass Code] key and enter a passcode with the numeric keys (maximum of 20 digits).

If you do not need to store a passcode, go to the next step.

**(3) Touch the [OK] key.**



- "\*" and "#" cannot be used in a sub-address.
- When the [Pass Code] key is touched, "/" appears.



**If an incorrect entry is made...**

Press the [CLEAR] key (C) and enter the correct digits.

8

### Touch the [Recipient] key.

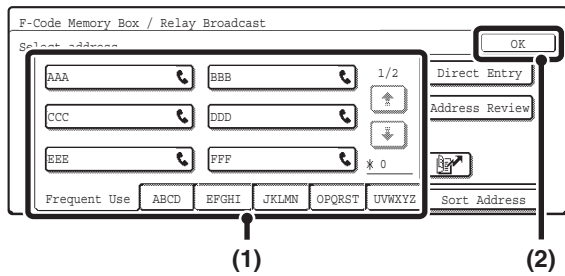

## Specify the end receiving machines.

### (1) Touch the keys of the end receiving machines.

The end receiving machines are entered in the order that they are touched.

### (2) Touch the [OK] key.



- To directly enter the fax number of an end receiving machine with the numeric keys, follow the steps below. Note that if "Disable Direct Entry" (page 188) is enabled in the system settings for fax (administrator), direct entry will not be possible.
  - Touch the [Direct Entry] key.
  - Enter fax number with the numeric keys.
  - Touch the [OK] key.
- To check the addresses that have been entered, touch the [Address Review] key in the address selection screen. To delete an end receiving machine, touch the key of the machine that you wish to delete and then touch the [Release] key. When you have finished checking the end receiving machines, touch the [OK] key.

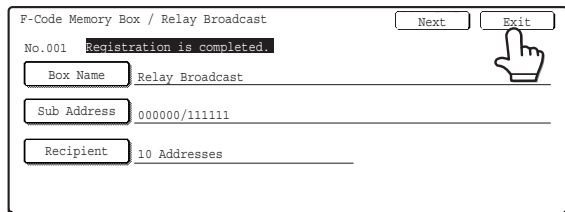

## Touch the [Exit] key.



- To program another memory box...**  
Touch the [Next] key and repeat the procedure from step 5.

# Editing and Deleting F-code Memory Boxes

1



Press the [SYSTEM SETTINGS] key.

2

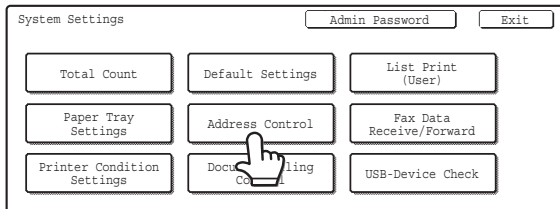

Touch the [Address Control] key.

3

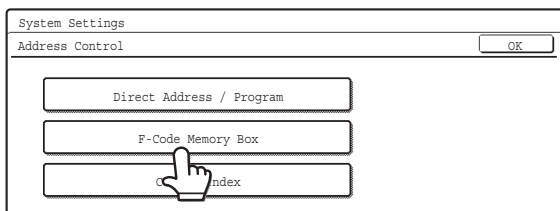

Touch the [F-Code Memory Box] key.

4

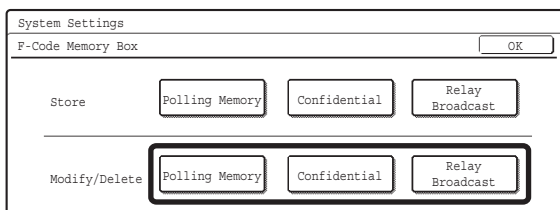

Touch the key of the function of the memory box that you wish to edit or delete.

5

**Example: Editing/deleting a memory box for polling memory**

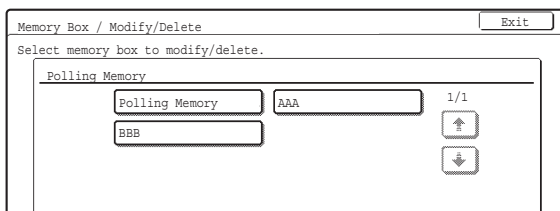

Touch the key of the memory box that you wish to edit or delete.

6

**Example: Editing/deleting a memory box for polling memory**

F-Code Memory Box / Polling Memory Delete Exit  
No.001  
Box Name Polling Memory  
Sub Address 000000/111111

**To edit the box...**

Touch the key of the item that you wish to change and then change the item in the same way as you programmed it. When finished, touch the [Exit] key.

- ▶ [Programming an F-code Memory Box \(Polling Memory\)](#) (page 149), [Programming an F-code Memory Box \(Confidential\)](#) (page 151), [Programming an F-code Memory Box \(Relay Broadcast\)](#) (page 154)

**To delete the box...**

Touch the [Delete] key and then touch [Yes] key in the deletion confirmation screen.



**To edit or delete another memory box...**

After finishing the above step, repeat the procedure from step 5.

7

**Example: Editing/deleting a memory box for polling memory**

Memory Box / Modify/Delete Exit  
Select memory box to modify/delete.  
Polling Memory  
AAA BBB 1/1  
↑  
↓

**Touch the [Exit] key.**

# Changing the Name of a Custom Index

You can change the name of a custom index used for individual and group keys.



For the procedure for entering text, see "6. ENTERING TEXT" in the User's Guide.

1



Press the [SYSTEM SETTINGS] key.

2

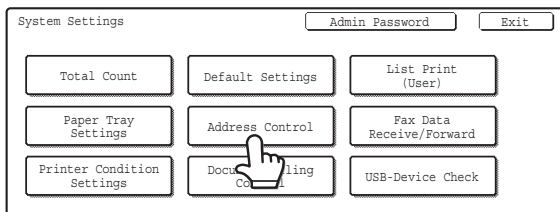

Touch the [Address Control] key.

3

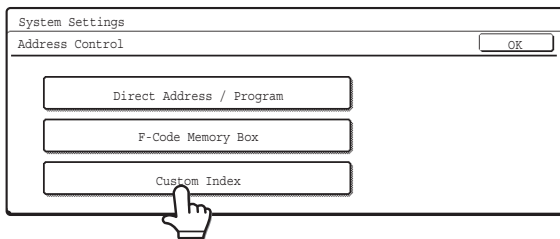

Touch the [Custom Index] key.

4

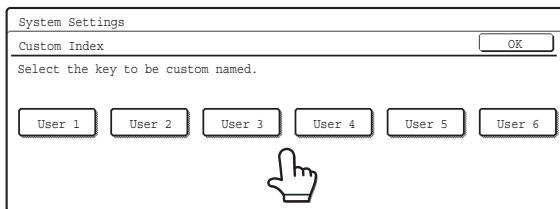

Change the index name.

- (1) Touch the key of the desired index.
- (2) Change the index name on the text entry screen that will appear.

Use the  key to clear the pre-entered name one character at a time, and then enter the desired name (maximum of 6 characters).

For the procedure for entering text, see "6. ENTERING TEXT" in the User's Guide.



- The factory default names for the custom indexes are "User 1" to "User 6".
- To change another custom index, repeat this procedure.

---

---

# Fax Data Receive/Forward

## Fax Receive Settings

Select the fax reception mode from the following modes

- Auto Reception: When a call comes in, the machine rings and then automatically receives the fax.
- Manual Reception: This can be used when an existing extension phone is connected to the machine. When a call comes in, you must answer on the extension phone and begin fax reception manually.

1



Press the [SYSTEM SETTINGS] key.

2

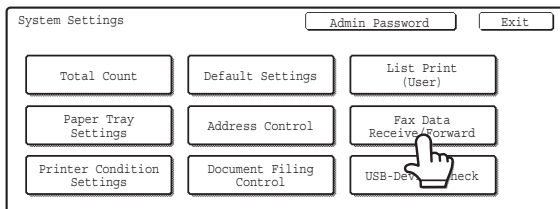

Touch the [Fax Data Receive/Forward] key.

3

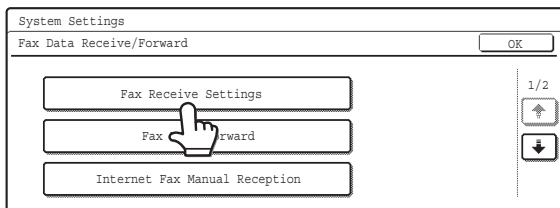

Touch the [Fax Receive Settings] key.

4

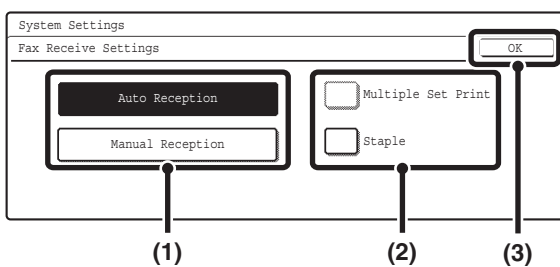

Select the receive mode.

(1) Touch the key of the desired receive mode.

(2) Select output settings.

When the checkbox of a setting is selected , the setting can be used. The settings that appear here are the settings that are configured in "Fax Output Settings" (page 184) in the system settings for fax (administrator).

(3) Touch the [OK] key.



---

---

# Accessing the System Settings (Administrator)

To access the system settings (administrator), the administrator must follow the procedure below to log in.



For the procedure for entering text, see "6. ENTERING TEXT" in the User's Guide.

## When User Authentication is not Enabled

When "User Authentication Setting" is not enabled, follow the procedure below to log in.  
For more information, see the System Settings Guide.

1



Press the [SYSTEM SETTINGS] key.

2

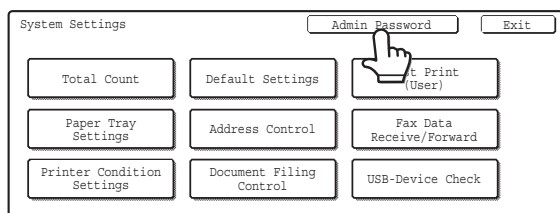

Touch the [Admin Password] key.

3

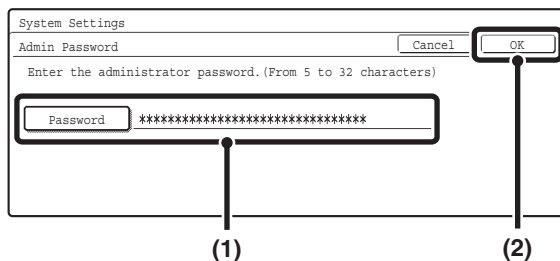

Log in.

(1) Touch the [Password] key and enter the administrator password.

For the procedure for entering text, see "6. ENTERING TEXT" in the User's Guide.

(2) Touch the [OK] key.

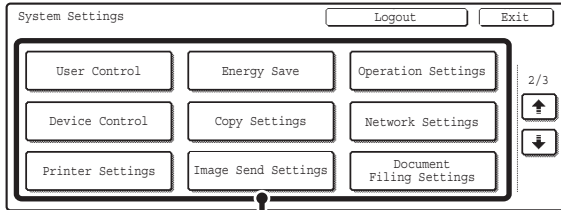
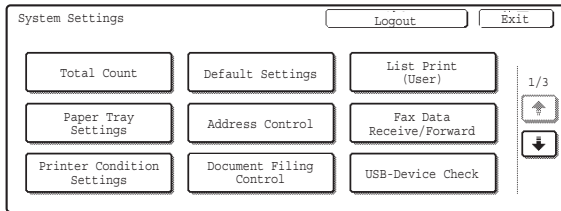

(A)

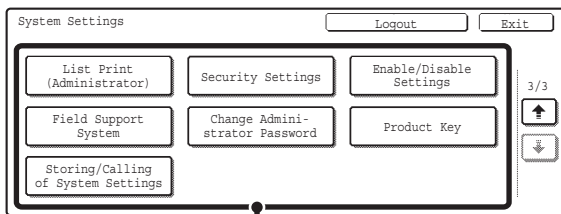

(A)

## Configure the desired system settings.

Touch the items that you wish to configure and select the desired settings.



- For detailed explanations of each of the settings, see the following pages of this chapter.
- Items marked (A) above are indicated as "System Settings (Administrator)" in this manual to distinguish them from the general user system settings.
- If Auto Clear activates, logout will automatically take place.
- **To logout...**  
Touch the [Logout] key in the top right corner of the screen.  
Touch the [Exit] key to quit the system settings.



User authentication is initially disabled (factory default setting).

# When User Authentication is Enabled

When "User Authentication Setting" is enabled, follow the procedure below to log in.



- For the procedure for enabling user authentication, see the System Settings Guide.
- When auto login is enabled, the login screen will not appear.

1

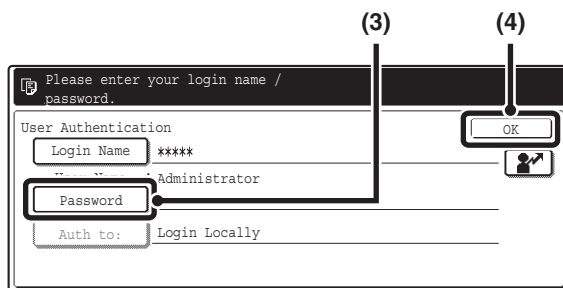
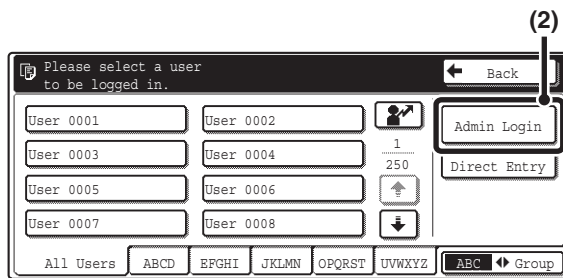
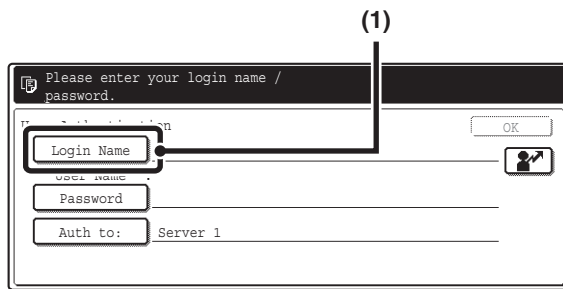

## ● Login by login name and password (and e-mail address\*)

### (1) Touch the [Login Name] key.

\* If login name / password / e-mail address is selected for the login method, [E-mail Address] will appear under the [Login Name] key shown at left.

### (2) Touch the [Admin Login] key.

### (3) Touch the [Password] key and enter the administrator password.

### (4) Touch the [OK] key and go to step 3.

## ● Login by user number

Touch the [Admin Login] key.

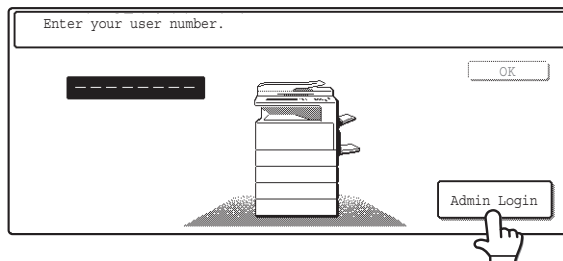

In addition to login in by touching the [Admin Login] key, the system settings (administrator) can also be accessed when login is performed by selecting a user with administrator rights from the user list or by entering a user number with administrator rights.

For these login procedures, see "[When User Authentication is Enabled](#)" (page 129).

2

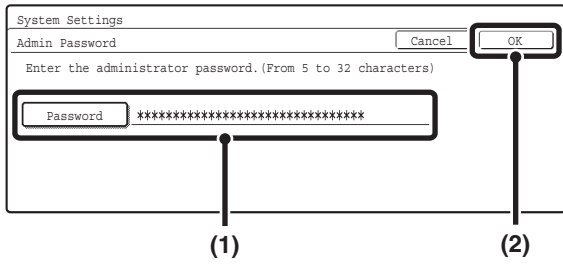

### Enter the administrator password.

(1) Touch the [Password] key and enter the administrator password.

For the procedure for entering text, see "6. ENTERING TEXT" in the User's Guide.

(2) Touch the [OK] key.

3



### Press the [SYSTEM SETTINGS] key.



This step is not necessary if you are logging in after you pressed the [SYSTEM SETTINGS] key.

4

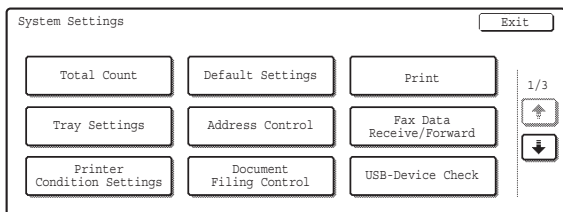

### Configure the desired system settings.

Touch the items that you wish to configure and select the desired settings.

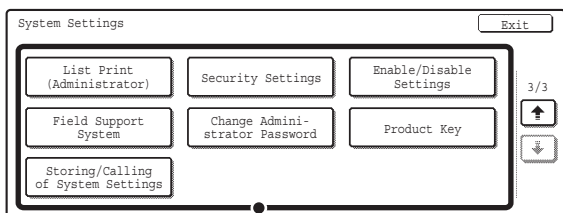
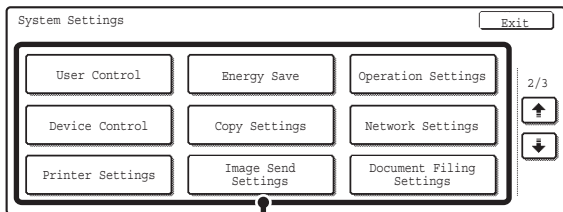

- For detailed explanations of each of the settings, see the following pages of this chapter.
- Items marked (A) above are indicated as "System Settings (Administrator)" in this manual to distinguish them from the general user system settings.
- If Auto Clear activates, logout will automatically take place.
- **To logout...**  
Press the [LOGOUT] key (⌘). (Except when entering a fax number.)

# System Settings (Administrator) List

When the system settings are accessed with administrator rights, the following items appear. The factory default setting for each item is also shown.

 Depending on the machine specifications and peripheral devices installed, it may not be possible to use some settings.

Item	Factory default setting	Page
■ <b>Operation Settings</b>		171
● <b>Keys Touch Sound</b>		171
▶ Keys Touch Sound	Medium	
▶ Keys Touch Sound at Initial Point	Disable	
● <b>Auto Clear Setting</b>	60 sec.	171
▶ Cancel Auto Clear Timer	Disable	
● <b>Message Time Setting</b>	6 sec.	171
● <b>Display Language Setting</b>	American English	171
● <b>Disabling of Job Priority Operation</b>	Disable	171
● <b>Disabling of Bypass Printing</b>	Disable	172
● <b>Key Operation Setting</b>	0.0 sec.	172
▶ Disable Auto Key Repeat	Disable	
● <b>Disabling of Clock Adjustment</b>	Disable	172
● <b>Disabling of Covers/Inserts Mode</b>	Disable	172
● <b>Customize Key Setting</b>		172
▶ Fax		
◆ Customize 1	Special Modes	
◆ Customize 2	File	
◆ Customize 3	Quick File	
■ <b>Device Control</b>		174
● <b>Original Size Detector Setting</b>		174
▶ Original Detection Size Combination	Inch-1	
▶ Cancel Detection at Document Glass	Disable	
● <b>Disabling of Document Feeder</b>	Disable	174
● <b>Original Feeding Mode</b>	All Disable	174
● <b>Disabling of Duplex</b>	Disable	174
● <b>Disabling of Large Capacity Cassette*1</b>	Disable	174

Item	Factory default setting	Page
■ <b>Image Send Setting</b>		175
● <b>Operation Settings</b>		175
▶ <b>Default Display Setting</b>		175
◆ Mode	Fax	
◆ Hold settings for a while after scanning has been completed	Disable	
◆ Switch Automatically to Copy Mode Screen	Enable	
▶ <b>Initial Resolution Setting</b>		175
◆ Apply the Resolution Set when Stored	Disable	
◆ Scanner	200x200 dpi	
◆ Internet Fax *2	200x100 dpi	
◆ Fax	Standard	
▶ <b>Default Exposure Settings</b>		175
◆ Exposure	Auto	175
◆ Original Image Type (Configuring the setting is only possible in scanner mode.)	Text	175
◆ Moiré Reduction (Configuring the setting is only possible in scanner mode.)	Disable	175
▶ <b>Must Input Next Address Key at Broadcast Setting</b>	Disable	176
▶ <b>Scan Complete Sound Setting</b>	Medium	176
▶ <b>The Number of File Name/Subject/Body Keys Displayed Setting</b>	6	176
▶ <b>The Number of Direct Address Keys Displayed Setting</b>	6	176
▶ <b>Disable Switching of Display Order</b>	Disable	176
▶ <b>Hold Setting for Received Data Print</b>		176
◆ Received Data Hold	Disable	
◆ Password Setting	–	
▶ <b>Settings to Disable the Registration of Destination</b>		177
◆ <b>Disable Registering Destination from Operation Panel</b>		
• Group	Disable	
• E-mail	Disable	
• Internet Fax*2	Disable	
• Fax	Disable	

Item	Factory default setting	Page
◆ Disable Registering Destination on Web Page		177
• Group	Disable	
• E-mail	Disable	
• FTP	Disable	
• Desktop	Disable	
• Network Folder	Disable	
• Internet Fax*2	Disable	
• Fax	Disable	
◆ Disable Registration Using Network Scan Tools		177
▶ Settings to Disable Transmission		
◆ Disable [Resend] on Fax/Image Send Mode		
◆ Disable Selection from the Address Book		
• E-mail	Disable	
• FTP	Disable	
• Desktop	Disable	
• Network Folder	Disable	
• Internet Fax*2	Disable	
• Fax	Disable	
◆ Disable Direct Entry		
• E-mail	Disable	
• Internet Fax*2	Disable	
• Fax	Disable	
◆ Disable PC-I-Fax Transmission*2	Disable	
◆ Disable PC-Fax Transmission	Disable	
● Fax Settings		178
▶ Fax Default Settings		
◆ Fax Own Name and Number Set	–	
◆ Dial Mode Setting	Tone	
◆ Auto Wake Up Print	Enable	
◆ Pause Time Setting	2 sec.	

Item	Factory default setting	Page
◆ Speaker Settings		
• Speaker	Middle	
• Ringer Volume	Middle	
• Line Monitor	Middle	
• Fax Receive Complete Signal	Volume: Middle; Tone Pattern: 3 Transmission Complete Sound Time Setting: 3 sec.	178
• Fax Send Complete Signal	Volume: Middle; Tone Pattern: 3 Transmission Complete Sound Time Setting: 3 sec.	
• Fax Communication Error Signal	Volume: Middle; Tone Pattern: 3 Transmission Complete Sound Time Setting: Every 0.3 seconds	
◆ Remote Reception Number Setting	5	179
◆ Original Print on Transaction Report	Print at Error	179
◆ Transaction Report Print Select Setting		
• Single Sending	Print Out Error Report Only	
• Broadcasting	Print Out All Report	179
• Receiving	No Printed Report	
• Confidential Reception	Print Out Notice Page	
◆ Activity Report Print Select Setting		
• Auto Print at Memory Full	Disable	179
• Print Daily at Designated Time	Disable	
◆ ECM	Enable	179
◆ Distinctive Ring Detection	Off	180
▶ Fax Send Settings		180
◆ Auto Reduction Sending Setting	Enable	180
◆ Rotation Sending Setting	All Enable	180
◆ Quick On Line Sending	Enable	180
◆ Printing Page Number at Receiver	Enable	180
◆ Date/Own Number Print Position Setting	Outside the Original Image	180
◆ Registration of Own Name Select	–	181
◆ Recall in Case of Line Busy	Recall, Number of Times: 2, Interval: 3 min.	182
◆ Recall in Case of Communication Error	Recall, Number of Times: 1, Interval: 3 min.	182
▶ Fax Receive Settings		182
◆ Number of Calls in Auto Reception	2	182
◆ Duplex Reception Setting	Disable	182
◆ Auto Receive Reduce Setting	Enable	182
◆ Print Style Setting	Auto Size Select	183
◆ Set the Telephone Number for Data Forwarding	–	183



Item	Factory default setting	Page
◆ A3 RX Reduce	Disable	183
◆ Anti Junk Fax Setting	–	183
◆ Fax Output Settings	Varies depending on the machine configuration	184
▶ Fax Polling Security		185
◆ Polling Security Setting	Enable	185
◆ Passcode Number Setting	–	185
■ List Print (Administrator)		186
● Administrator Settings List		186
▶ Copy	–	
▶ Print	–	
▶ Image Send	–	
▶ Document Filing	–	
▶ Security	–	
▶ Common	–	
▶ All Administrator Settings List	–	
● Image Sending Activity Report* <sup>2</sup>		186
▶ Image Sending Activity Report (Scanner)	–	
▶ Image Sending Activity Report (Internet Fax)	–	
▶ Image Sending Activity Report (Fax)	–	
● Anti Junk Fax Number List	–	186
● Anti Junk Mail/Domain Name List* <sup>2</sup>	–	186
● Inbound Routing List	–	186
● Document Admin List	–	186
● Web Setting List	–	186
● Metadata Set List	–	186
■ Enable/Disable Settings		187
● Image Send Settings		187
▶ Disable Switching of Display Order	Disable	187
▶ Disable Scan Function	Disable	187
• PC Scan	Disable	
• USB Memory Scan	Disable	

Item	Factory default setting	Page	
▶ Settings to Disable the Registration of Destination		187	
◆ Disable Registering Destination from Operation Panel			
• Group	Disable		
• E-mail	Disable		
• Internet Fax	Disable		
• Fax	Disable	187	
◆ Disable Registering Destination on Web Page			
• Group	Disable		
• E-mail	Disable		
• FTP	Disable		
• Desktop	Disable		
• Network Folder	Disable		
• Internet Fax	Disable		
• Fax	Disable		
◆ Disable Registration Using Network Scan Tools		Disable	
▶ Settings to Disable Transmission		188	
◆ Disable [Resend] on Fax/Image Send Mode			Disable
◆ Disable Selection from the Address Book			
• E-mail	Disable		
• FTP	Disable		
• Desktop	Disable		
• Network Folder	Disable		
• Internet Fax	Disable		
• Fax	Disable		
◆ Disable Direct Entry			
• E-mail	Disable		
• Internet Fax	Disable		
• Fax	Disable		
◆ Disable PC-I-Fax Transmission*2			Disable
◆ Disable PC-Fax Transmission			Disable

\*1 When a large capacity tray is installed.

\*2 When the internet fax expansion kit is installed.

# Operation Settings

This section explains settings that are related to machine operation. Touch the [Operation Settings] key and configure the settings.

## Keys Touch Sound

This setting is used to adjust (or turn off) the volume of the beep that sounds when you touch a key. You can also have three beeps sound at initial values when setting the ratio in copy mode or when adjusting the exposure in any mode.

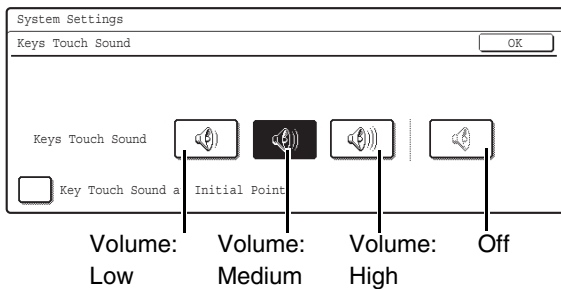

Select one of the keys and touch the [OK] key. When "Key Touch Sound at Initial Point" is selected , three beeps will sound at the initial values indicated below.

Screen in which setting is effective	Initial value
Ratio setting screen in base screen of copy mode	Ratio 100%
Exposure adjustment screen in base screen of copy mode	Exposure level 3 (middle level)
Exposure adjustment screen in base screen of fax, Internet fax, and network scanner modes	
Exposure adjustment screen in [Scan to HDD] in base screen of document filing mode	

## Auto Clear Setting

The time until Auto Clear activates can be set to any number of minutes from 10 to 240. Make sure the [Cancel Auto Clear Timer] checkbox is not selected , specify the time with the   keys, and touch the [OK] key. (To make the number change quickly, keep your finger on the  or  key.) If the machine is not used for the duration of time set here, the auto clear function will clear any settings that have been selected and return the screen to the base screen of copy mode or the job status screen. If you do not want Auto Clear to operate, select the [Cancel Auto Clear Timer] checkbox .

## Message Time Setting

The duration of time that messages appear in the display (the time until a message is automatically cleared) can be set to any number of seconds from 1 to 12. Specify the time with the   keys and touch the [OK] key. (To make the number change quickly, keep your finger on the  or  key.)

## Display Language Setting

The language that appears in the display can be changed. Select one of the keys and touch the [OK] key.

## Disabling of Job Priority Operation

The job priority function can be disabled. When this is done, the [Priority] key will not appear in the job status screen. To enable this setting, select the checkbox  and touch the [OK] key.

## Disabling of Bypass Printing

This setting is used to disable bypass printing (printing other jobs ahead of a job that has been stopped\* because the paper required for the job is not in any of the trays).

To enable this setting, select the checkbox  and touch the [OK] key.

\* This does not include cases where the paper ran out during the job.

## Key Operation Setting

This setting determines how long a key in the touch panel must be touched until the key input is registered. The time can be set from 0 to 2 seconds in increments of 0.5 seconds.

By lengthening the time setting, key input can be prevented when a key is touched accidentally. Keep in mind, however, that when a longer setting is selected more care is required when touching keys to ensure that key input is registered.

Specify the time with the   keys and touch the [OK] key. (To make the number change quickly, keep your finger on the  or  key.)

To disable auto repeat of key input, select the [Disable Auto Key Repeat] checkbox  and touch the [OK] key.



The touch panel contains keys such as the zoom keys (for setting the ratio) that can be touched continuously to make a value change until it reaches a desired value. This feature whereby a value changes continuously while your finger is on the key is called key repeat.

## Disabling of Clock Adjustment

This setting is used to prohibit changing of the date and time.

To enable this setting, select the checkbox  and touch the [OK] key.

## Disabling of Covers/Inserts Mode

This setting is used to prohibit the use of the covers and inserts function.

To enable this setting, select the checkbox  and touch the [OK] key.

## Customize Key Setting

Short-cuts to functions that are frequently used can be displayed as keys in the lower right corner of the base screen of each mode.

### 1 Touch the key of the mode for which you wish to configure customized keys.

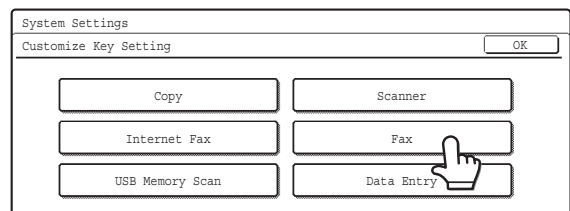

### 2 Touch the key that you wish to configure.

To return all of the customized key settings to the factory default settings, touch the [Back to Default] key.

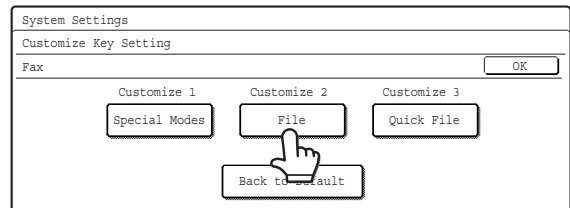

### 3 Touch the [Setup Items] key.

If you do not want the selected customized key to appear in the base screen, select the [No Display] checkbox .

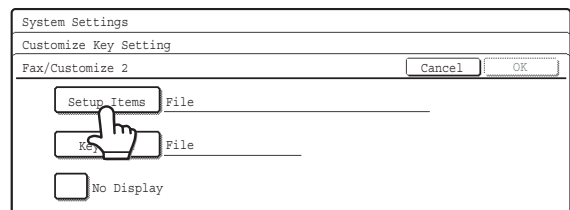

### 4 Select the function that you wish to show in the customized key.

Select the key of the desired function and touch the [Details] key. Select the desired settings in the screen that appears and touch the [OK] key.

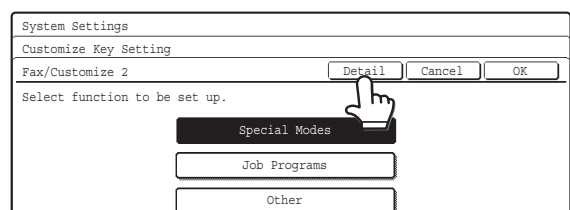

## 5 Touch the [OK] key.

If you wish to change the name of the customized key, touch the [Key Name] key and enter the desired name.

The customized keys in the base screen of the selected mode will change to reflect the settings.

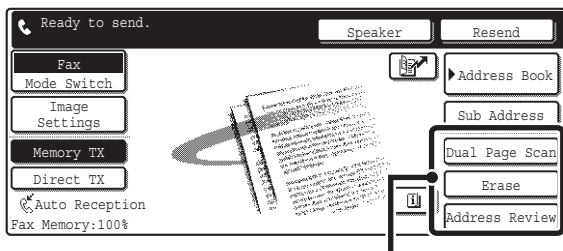

Customize keys

# Device Control

These settings control devices installed on the machine. Touch the [Device Control] key and configure the settings.

## Original Size Detector Setting

One of the five groups of standard original sizes shown below can be selected for detection by the original size detection function.

Select one of the keys and touch the [OK] key.

Selections	Detectable original sizes	
	Document glass	Document feeder tray (automatic document feeder)
INCH-1	11" x 17", 8-1/2" x 14", 8-1/2" x 11", 8-1/2" x 11"R, 5-1/2" x 8-1/2"	11" x 17", 8-1/2" x 14", 8-1/2" x 11", 8-1/2" x 11"R, 5-1/2" x 8-1/2", A4, A3
INCH-2	11" x 17", 8-1/2" x 13", 8-1/2" x 11", 8-1/2" x 11"R, 5-1/2" x 8-1/2"	11" x 17", 8-1/2" x 13", 8-1/2" x 11", 8-1/2" x 11"R, 5-1/2" x 8-1/2", A4, A3
AB-1	A3, A4, A4R, A5R, B4, B5, B5R	A3, B4, A4, A4R, B5, B5R, 8-1/2" x 13", 8-1/2" x 14", 11" x 17"
AB-2	A3, A4, A4R, A5R, B4, B5, B5R 216 mm x 330 mm	A3, A4, A4R, A5, B4, B5, B5R, 8-1/2" x 11", 11" x 17", 216 mm x 330 mm
AB-3	A4, A4R, A 5, B4, 8K, 16K, 16KR	A3, A4, A4R, A 5, B4, 8K, 16K, 16KR, 8-1/2" x 11", 11" x 17", 216 mm x 330 mm

To disable detection of original sizes on the document glass, select the [Cancel Detection at Document Glass] checkbox  and touch the [OK] key.



If "Cancel Detection at Document Glass" is selected, all originals placed on the document glass will be treated as special size originals.

## Disabling of Document Feeder

Use this setting to prohibit the use of the automatic document feeder, such as when the feeder malfunctions. (When the setting is enabled, scanning is still possible using the document glass.)

To enable this setting, select the checkbox  and touch the [OK] key.

## Original Feeding Mode

The following original feeding modes can be set to operate by default in image send mode. When a mode is frequently used, this saves you from having to select the mode in the special modes each time it is used.

- Mixed Size Original (Different Width)
- Slow Scan Mode

System Settings			
Original Feeding Mode			
	Mixed Size Doc. Same Width	Mixed Size Doc. Different Width	Slow Scan Mode
Copy	<input type="checkbox"/>	<input type="checkbox"/>	<input type="checkbox"/>
Scan to HDD		<input type="checkbox"/>	<input type="checkbox"/>
Image Send		<input type="checkbox"/>	<input type="checkbox"/>

To use this setting, select the checkboxes  of the desired items and touch the [OK] key.

## Disabling of Duplex

This is used to disable two-sided printing, such as when the duplex module malfunctions.

To enable this setting, select the checkbox  and touch the [OK] key.

## Disabling of Large Capacity Cassette

(When a large capacity cassette is installed.)

This setting is used to prohibit the use of the large capacity cassette, such as when the cassette malfunctions.

To enable this setting, select the checkbox  and touch the [OK] key.

---

---

# Image Send Setting

Scan, Internet fax, and fax settings are described below.

## Operation Settings

Scan, Internet fax, and fax settings are described below.

Touch the [Image Send Settings] key and then the [Operation Settings] key, and configure the settings.

---

### Default Display Setting

Five screen selections are available for the base screen that appears when you press the [IMAGE SEND] key, or when you press the [CLEAR ALL] key () in image send mode.

- Address Book (ABC)
- Address Book (Group)
- Scanner
- Internet Fax
- Fax

When [Switch Automatically to Copy Mode Screen] is selected , the display will automatically switch to the copy mode screen if no action is taken in the image send mode screen for 20 seconds.

When the [Hold settings for a while after scanning has been completed] checkbox is selected , the settings will remain in effect a fixed period of time after scanning is completed.

---

### Initial Resolution Setting

The following settings are available for the default resolutions of scan, Internet fax, and fax mode.

- Scanner: 100x100dpi  
200x200dpi  
300x300dpi  
400x400dpi  
600x600dpi
- Internet Fax: 200x100dpi  
200x200dpi  
400x400dpi  
600x600dpi } Half Tone
- Fax: Standard  
Fine  
Super Fine  
Ultra Fine } Half Tone

When using a stored image file, select the [Apply the Resolution Set when Stored] checkbox  and touch the [OK] key to use the resolution set when the file was stored.



---

### Default Exposure Settings

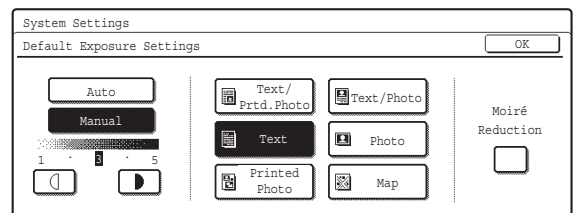
This setting is used to set the default exposure level for scanning originals in image send mode.



#### • Exposure

The exposure can be adjusted automatically or manually. Select either the [Auto] key or the [Manual] key. If the [Manual] key is selected, specify the exposure with the   keys and touch the [OK] key. Lower the level toward "1" for lighter exposure or raise the level toward "5" for darker exposure.

#### • Original Image Type (Configuring the setting is only possible in scanner mode.)

The exposure mode can be selected to match the original type. Select the desired key and touch the [OK] key.

- Text/Prt'd. Photo
- Text/Photo
- Text
- Photo\*
- Printed Photo\*
- Map\*

\* Does not appear when the exposure is set to [Auto].

#### • Moiré Reduction (Configuring the setting is only possible in scanner mode.)

To reduce the moire effect when scanning, select the [Moiré Reduction] checkbox  and touch the [OK] key.

---

## Must Input Next Address Key at Broadcast Setting

This setting is used to require that the [Next Address] key be touched before the next address is entered when performing a broadcast transmission.

When this setting is enabled, the [Next Address] key cannot be omitted even if the next address is entered with a one-touch key.

If a user attempts to enter the next address without touching the [Next Address] key, a double-beep alarm will sound and the entry will be rejected.

To enable this setting, select the checkbox  and touch the [OK] key.

---

## Scan Complete Sound Setting

The scan complete sound can be selected.

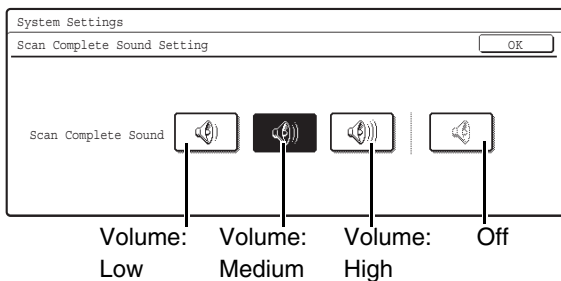

Select one of the keys and touch the [OK] key.

---

## The Number of File Name/Subject/Body Keys Displayed Setting

This setting is used to select the number of file name / subject keys that are displayed in the screen. The number of keys can be set to 3 or 6.

Select one of the keys and touch the [OK] key.

---

## The Number of Direct Address Keys Displayed Setting

This setting is used to select the number of one-touch keys that are displayed in the Address Book screen. The number of keys can be set to 6 or 9.

Select one of the keys and touch the [OK] key.

---

## Disable Switching of Display Order

This is used to prohibit changes to the order of display (order search number, ascending, descending) in the Address Book.

When this setting is enabled, touching a tab in the Address Book screen does not change the order. The currently selected display order will be the order that is used after the setting is selected.

To enable this setting, select the checkbox  and touch the [OK] key.

---

## Hold Setting for Received Data Print

This function holds received faxes and Internet faxes in memory without printing them. The faxes can be printed by entering a password (factory default setting: 0000) with the numeric keys.

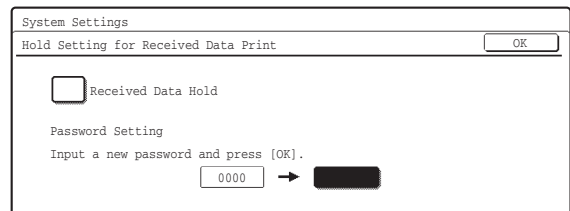

To enable this setting, select the [Received Data Hold] checkbox , enter a password with the numeric keys, and touch the [OK] key.



---

## Settings to Disable the Registration of Destination

This is used to prohibit the storing of destinations. Storing from the machine, storing from the Web page, and storing from a computer can each be separately prohibited.

### Disable Registering Destination from Operation Panel

Disables address control from the machine.

To use this setting, select the desired items  and touch the [OK] key.

- Group
- E-mail
- Internet Fax
- Fax

(When the [Select/Cancel All] key is touched, all settings become . When the key is touched in the checked condition, all settings become .)

### Disable Registering Destination on Web Page

**(When network connection is enabled.)**

Disable address control from the Web page.

To use this setting, select the checkboxes  of the desired items from the followings and touch the [OK] key.

- Group
- E-mail
- FTP
- Desktop
- Network Folder
- Internet Fax
- Fax

(When the [Select/Cancel All] key is touched, all settings become . When the key is touched in the checked condition, all settings become .)

### Disable Registration Using Network Scan Tools

**(When network connection is enabled.)**

Disable address control from the Network Scanner Tool.

To enable this setting, select the checkbox  and touch the [OK] key.

---

## Settings to Disable Transmission

These settings are used to disable the following transmission operations.

### Disable [Resend] on Fax/Image Send Mode

Disable the use of the [Resend] key on the basic screen of image send mode.

To enable this setting, select the checkbox  and touch the [OK] key.

### Disable Selection from the Address Book

This is used to disable selecting the destination from the Address Book.

To use this setting, select the checkboxes  of the desired items from the followings and touch the [OK] key.

- E-mail
- FTP
- Desktop
- Network Folder
- Internet Fax
- Fax

(When the [Select/Cancel All] key is touched, all settings become . When the key is touched in the condition, all settings become .)

### Disable Direct Entry

This prohibits the direct entry of the address.

To use this setting, select the checkboxes  of the desired items from the followings and touch the [OK] key.

- E-mail
- Internet Fax
- Fax

(When the [Select/Cancel All] key is touched, all settings become . When the key is touched in the checked condition, all settings become .)

### Disable PC-I-Fax Transmission

**(When Internet fax expansion kit is installed.)**

Disable transmission from PC-I-Fax.

To enable this setting, select the checkbox  and touch the [OK] key.

### Disable PC-Fax Transmission

**(When the facsimile expansion kit is installed.)**

Disable transmission from PC-Fax.

To enable this setting, select the checkbox  and touch the [OK] key.

# Fax Default Settings

The fax default settings can be configured to suit the needs of your workplace.

Touch the [Image Send Settings] key, the [Fax Settings] key, and then the [Fax Default Settings] key to configure the settings.

## Fax Own Name and Number Set

Use this setting to enter the fax number of the machine and the name of the user. The entered name and number are printed at the top of each fax page you send.

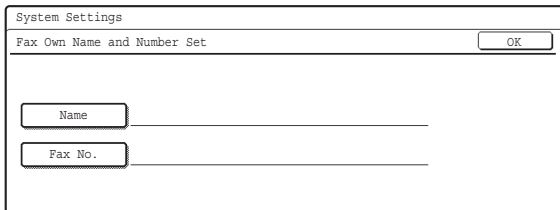

### 1 Touch the [Name] key and enter the name.

Up to 20 characters can be entered.

When you have finished entering the name, touch the [OK] key.



For the procedure for entering text, see "6. ENTERING TEXT" in the User's Guide.

### 2 Touch the [Fax No.] key to enter the fax number of the machine.

Enter the number with the numeric keys (maximum of 20 digits).

To enter "+", press the [\*] key.

To enter a hyphen (-), touch the [Pause] key. To enter a space, touch the [Space] key.



If a hyphen "-" is entered, it will be changed to a space at the time of transmission.



### 3 Touch the [OK] key.

## Dial Mode Setting

Select the appropriate setting for your telephone line type.

It is also possible to have the machine automatically select the line type. Make sure that the telephone line is connected to the machine and then touch the [Auto Select] key. The machine will automatically select "Tone" for a tone dial line or "Pulse" for a pulse dial line.

## Auto Wake Up Print





When the [POWER] key () is "off" (but the main power switch is "on") and a fax is received, this function automatically activates the machine and prints the fax. When this function is disabled, received faxes are not printed until the [POWER] key () is switched "on". To enable this setting, select the checkbox  and touch the [OK] key.

## Pause Time Setting

This setting is used to select the duration of pauses that are inserted in destination fax numbers.

If the [Pause] key is touched when dialing or storing a fax number, a pause of 2 seconds is inserted.

The duration of each pause can be set to any number of seconds from 1 to 15.

Specify the number with the   keys and touch the [OK] key. (To make the number change quickly, keep your finger on the  or  key.)

## Speaker Settings

Use these settings to set the sound heard from the speaker for the Speaker, Ringer Volume, Line Monitor, Fax Receive Complete Signal, Fax Send Complete Signal, and Fax Communication Error Signal.

Select Small, Middle, Big, or No Sound for the volume (Small, Middle, or Big for the speaker volume).

For the Fax Receive Complete Signal, the Fax Send Complete Signal, and the Fax Communication Error Signal, the Tone Pattern and Transmission Complete Sound Time Setting can also be selected, and the selected volume and pattern can be checked by pressing the [Check on Setup Sounds] key.

### Example: Fax Send Complete Signal settings screen

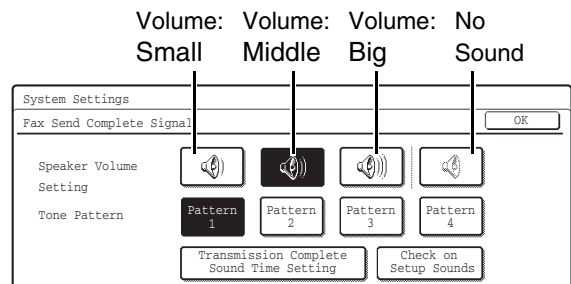

To change a setting, touch the appropriate key to highlight the desired setting and touch the [OK] key.

## Remote Reception Number Setting

Fax reception can be activated from an extension phone connected to the machine by entering a 1-digit number and pressing the **(\*)** key twice on the phone's keypad. This number is called the remote reception number, and you can set it to any number from "0" to "9".

Specify the number with the **(v)** **(^)** keys and touch the **[OK]** key. (To make the number change quickly, keep your finger on the **(v)** or **(^)** key.)

## Original Print on Transaction Report

When a transaction report is printed following a memory transmission, this setting is used to have part of the first page of the original printed on the transaction report. When printing of transaction reports is disabled, this function will not operate.

Select **[Print Out All Report]**, **[Print Out Error Report Only]**, or **[No Printed Report]** for the condition for printing the original on transaction reports and touch the **[OK]** key.

## Transaction Report Print Select Setting

These settings are used to set the conditions for printing transaction reports for single transmissions, broadcast transmissions, receptions, and confidential receptions. For each type of operation, touch the key of the desired condition.

### Single Sending

Print Out All Report

Print Out Error Report Only

No Printed Report

### Broadcasting

Print Out All Report

Print Out Error Report Only

No Printed Report

### Receiving

Print Out All Report

Print Out Error Report only

No Printed Report

### Confidential Reception

Print Out Notice Page

Not Print Out Notice Page

The default settings are indicated in gray .

## Activity Report Print Select Setting

This is used to have the Image Sending Activity Report that is stored in the machine's memory printed at regular intervals.

The Image Sending Activity Report can be set to automatically print each time the number of transactions reaches 200, and it can also be set to automatically print at a specified time (once a day only). (Both settings can be selected.)

When the **[Auto Print at Memory Full]** checkbox  is selected, the Image Sending Activity Report will automatically print when the number of transactions reaches 200.

To have the report print automatically at a specified time, select the **[Print Daily at Designated Time]** checkbox . The "Hour" and "Minute" keys will appear at the right.

Touch the "Hour" and "Minute" keys and specify the setting of each with the **(v)** **(^)** keys. When finished, touch the **[OK]** key. The report will print at the specified time.



- If you only select the **[Print Daily at Designated Time]** checkbox  and the number of recorded transactions exceeds 199 before the specified time, each new transaction will delete the oldest transaction (the oldest transaction will not be printed).
- The Image Sending Activity Report can also be printed manually. See "[List Print \(Administrator\)](#)" (page 186).

## ECM

Line conditions can sometimes distort a transmitted fax image. When ECM (Error Correction Mode) is turned on, pages that are distorted are automatically re-transmitted. To enable this setting, select the checkbox  and touch the **[OK]** key.



If the other machine supports Super G3, ECM will function regardless of this setting.

---

## Distinctive Ring Detection

If multiple telephone numbers have been assigned to your telephone line, the number called can be identified by its ringing pattern. By using one number for voice calls and another number for faxes, you can tell which type of call you are receiving by the ringing pattern. You can set your machine to automatically receive faxes when your fax number is called by setting the pattern that corresponds to your fax number. Six selections are available.

To use this setting, touch the key of the desired pattern and touch the [OK] key.

## Fax Send Settings

The fax send settings are used to enable or disable certain fax functions to better suit the needs of your workplace. Touch the [Image Send Settings] key, the [Fax Settings] key, and then the [Fax Send Settings] key to configure the settings.

---

### Auto Reduction Sending Setting

This setting is used to have the size of transmitted faxes automatically reduced to match the size of the paper in the receiving machine.

If the setting is disabled, faxes are sent at full size. Because the size is not adjusted to match the size of the printing paper, part of the received fax may be cut off. To enable this setting, select the checkbox  and touch the [OK] key.

---

### Rotation Sending Setting

When transmitting an image that is one of the following sizes, this function rotates the image counterclockwise 90 degrees.

8-1/2" x 11", 5-1/2" x 8-1/2"R, A4, B5R, A5R, 16K

To use this setting, select the checkboxes  of the desired sizes and touch the [OK] key.



8-1/2" x 11"R and A4R size images are not rotated.

---

### Quick On Line Sending

When this setting is enabled, the machine starts transmitting a fax as soon as the first page is scanned. Transmission takes place at the same time as the remaining pages are being scanned.

If you disable this setting, transmission will not begin until all pages have been scanned. Note that this setting does not apply to manual transmission.

To enable this setting, select the checkbox  and touch the [OK] key.

---

### Printing Page Number at Receiver

This setting is used to add the page number to the top of each fax page printed by the receiving machine.

To enable this setting, select the checkbox  and touch the [OK] key.

---

### Date/Own Number Print Position Setting

This setting determines the position of the date and sender information printed at the top of faxes by the receiving machine. To have the information printed outside the transmitted document image, touch the [Outside the Original Image] key. To have the information printed inside the document image, touch the [Inside the Original Image] key.

## Registration of Own Name Select

This is used to store sender names used in "Own Number Select".

☞ [TEMPORARILY CHANGING THE SENDER INFORMATION \(Own Number Select\)](#) (page 85)

Up to 18 numbers (maximum of 20 digits each) can be stored. Control numbers are from 01 to 18. The lowest number not yet in use is automatically assigned when you begin the storing procedure. This number cannot be changed.

### Storing a sender name

- 1 Touch the [Enter] key.
- 2 Touch the [Name] key.

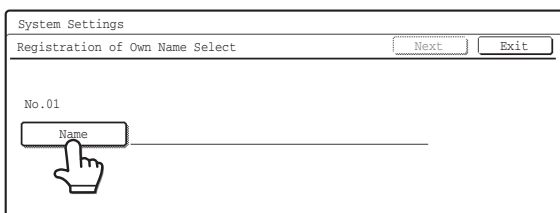

- 3 Enter the sender name.

To enter text, see the "Users Guide".

- 4 Touch the [OK] key.

The sender name is stored. To store another sender name, touch the [Next] key and repeat the procedure from step 2.

- 5 Touch the [Exit] key.

### Editing a sender name

- 1 Touch the [Modify/Delete] key.
- 2 Touch the desired sender name key.
- 3 Touch the [Name] key.

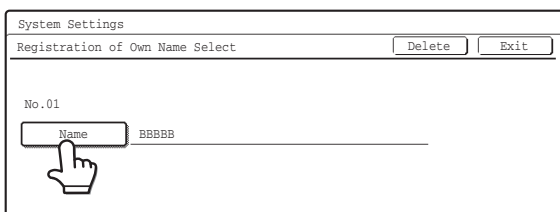

- 4 Edit the sender name and touch the [OK] key.

The edited sender name is stored.

- 5 Touch the [Exit] key.

### Deleting a sender name

- 1 Touch the [Modify/Delete] key.
- 2 Touch the sender name key that you wish to delete.
- 3 Touch the [Delete] key.

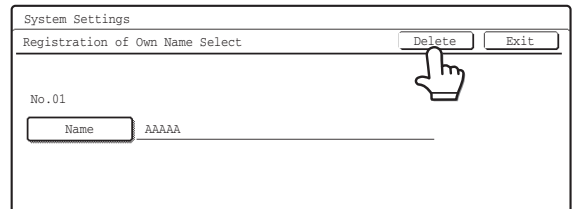

- 4 Touch the [Yes] key.

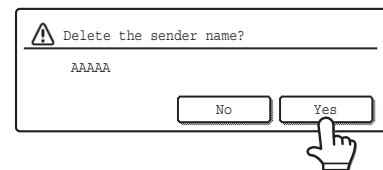

- 5 Touch the [Exit] key.

---

## Recall in Case of Line Busy

This program is used to set the number of recall attempts and the interval between recall attempts when a transmission is not successful due to the line being busy or other reason.

The number of recall attempts can be set to any number from 1 to 14, and the interval between attempts can be set to any number of minutes from 1 to 15. Specify each number with the   keys. (To make the number change quickly, keep your finger on the  or  key.) If you do not wish to have recalling take place, select the [Turn off Recall] checkbox  and touch the [OK] key.



When this setting is enabled, note that your machine will not re-attempt a call when manual transmission or direct transmission is used.

---

## Recall in Case of Communication Error

This setting determines whether or not your machine will re-attempt the call if a fax transmission fails due to a line error.

The number of recall attempts can be set to 1 and the interval between attempts can be set to any number of minutes from 1 to 15.

(To make the number change quickly, keep your finger on the  or  key.)

If you do not wish to have recalling take place, select the [Turn off Recall] checkbox  and touch the [OK] key.



When this setting is enabled, note that your machine will not re-attempt a call when manual transmission or direct transmission is used.

## Fax Receive Settings

The fax reception settings can be enabled or disabled to suit the needs of your workplace.

Touch the [Image Send Settings] key, the [Fax Settings] key, and then the [Fax Receive Settings] key to configure the settings.

---

## Number of Calls in Auto Reception

This setting is used to select the number of rings on which the machine automatically receives a call and begins fax reception in auto reception mode. Any number from 0 to 15 can be selected.

Specify the number with the   keys and touch the [OK] key. (To make the number change quickly, keep your finger on the  or  key.)



If you select "0" for the number of rings, the machine will immediately answer and begin fax reception without ringing in auto reception mode.

---

## Auto Receive Reduce Setting

When a fax is received that includes the sender's name and number, the received image is slightly larger than the standard size\*. This setting is used to automatically reduce the image to fit the standard size.

To enable this setting, select the checkbox  and touch the [OK] key.



If Auto Receive Reduce is disabled, the edges of the image outside the standard size will be cut off. However, the image will be clearer because it will be printed at full size.

\* Standard sizes are sizes such as 8-1/2" x 11" and 8-1/2" x 5-1/2" (A4 and B5).

---

## Duplex Reception Setting

This used to have received faxes printed on both sides of the paper.

When this setting is enabled and a fax consisting of 2 or more pages is received (the pages must be the same size), the pages are printed on both sides of the paper.

To enable this setting, select the checkbox  and touch the [OK] key.

---

## Print Style Setting

This setting determines the paper selection condition when printing received faxes. Select one of the three conditions below.

### [Print Actual Size Cut off Disabled]

The received fax image is printed at full size without dividing it onto multiple sheets of paper. If the same size of paper or larger paper is not loaded, the fax will be received in memory and will not be printed until a suitable size of paper is loaded.

However, if the received fax is longer than 11" x 17" (A3) size, it will be automatically divided onto multiple sheets of paper.

### [Print Actual Size Cut off Enabled]

Each received image is printed at full size. If necessary, the image is divided onto multiple sheets of paper.

### [Auto Size Select]

Each received image is printed at full size when possible. When not possible, the image is automatically reduced before printing.

Touch the key of the desired paper selection condition and touch the [OK] key.

---

## Set the Telephone Number for Data Forwarding

When a problem prevents the machine from printing a received fax, the received fax can be forwarded to another fax machine. This setting is used to program the fax number of the destination fax machine. Only one forwarding fax number can be programmed (maximum of 64 digits).

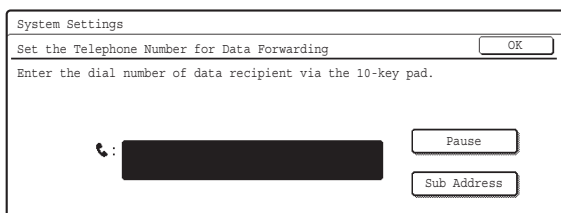

Enter the forwarding fax number with the numeric keys. To insert a pause between digits of the number, touch the [Pause] key.

If you wish to specify an F-code confidential memory box in the destination machine, touch the [Sub Address] key after entering the fax number and enter the F-code (sub-address and passcode).

---

## A3 RX Reduce

When this program is enabled and an A3 size fax is received, the fax is reduced to letter width before printing.

When the program is enabled, W letter is considered to be the same size as A3, thus W letter faxes are also reduced before printing.

To enable this setting, select the checkbox  and touch the [OK] key.

---

## Anti Junk Fax Setting

This setting is used to block fax reception from specified fax numbers (anti junk fax numbers).

Up to 50 anti junk fax numbers can be stored.

To enable the Anti Junk Fax setting, touch the [Enable] key. To disable the setting, touch the [Disable] key. After selecting the setting, touch the [OK] key.

---

### Entering anti junk fax numbers

#### 1 Touch the [Enter] key.

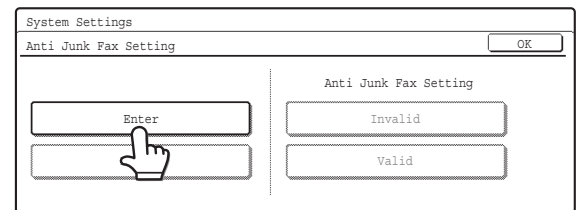

#### 2 Press the numeric keys to store the fax number.

Up to 20 digits can be entered.

To store another fax number, touch the [Next] key and enter the number.

#### 3 Touch the [OK] key.

---

### Deleting an anti junk fax number

#### 1 Touch the [Delete] key.

#### 2 Touch the key of the number that you wish to delete.

#### 3 Touch the [Yes] key.

#### 4 Touch the [OK] key.

## Fax Output Settings

These settings are used to select the number of copies and output tray for received faxes. When a finisher or a saddle stitch finisher is installed, the output tray and stapling can be selected.

Touch the key of the desired output tray. Open the number of copies screen with the  key.

Enter number of copies to be printed with the numeric keys and touch the [OK] key.

When a finisher is installed, enter the number of copies and then touch the keys for the desired staple position and paper size.

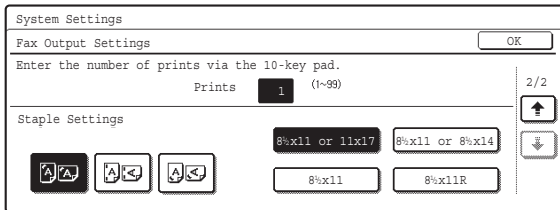

- This setting can only be used when the [Staple] checkbox is selected  in the "Fax Receive Settings" (page 160).
- When a saddle stitch finisher is installed, the number of sheets that can be stapled is 30. When a finisher is installed, the number of sheets that can be stapled is 50 for 8-1/2" x 11" (A4), letter, and 5-1/2" x 8-1/2" (B5) sizes and 30 for other sizes.



# Fax Polling Security

The following settings are for regular polling memory using the Public Box.

Touch the [Image Send Settings] key, the [Fax Settings] key, and then the [Fax Polling Security] key to configure the settings.



Note that these settings do not apply to F-code polling memory.

## Polling Security Setting

When the memory polling function is used, this setting determines whether any machine will be allowed to poll your machine, or only machines that have been specified in your machine.

To enable this setting, select the checkbox  and touch the [OK] key.



If the Polling Security Setting is enabled, enter the numbers of the fax machines that will be allowed to poll your machine in "Passcode Number Setting" below.

## Passcode Number Setting

When the Polling Security Setting is enabled (see above), use this setting to store (or delete) the fax numbers of the machines that are allowed to poll your machine. The stored fax numbers are called passcode numbers. Up to 10 passcode numbers can be stored.

### Storing passcode numbers

- 1 Touch the [Enter] key.
- 2 Touch a key that has no number stored (a blank key).

If numbers have been stored in all of the keys, a message will appear and no further numbers can be stored. First delete a number that is no longer needed and then store the new number.

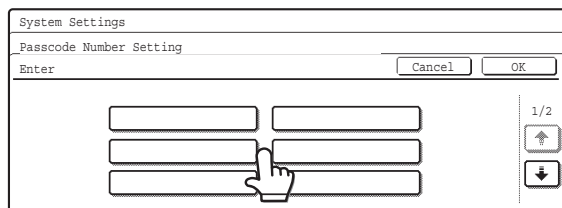

- 3 Press the numeric keys to store the fax number.

Up to 20 digits can be entered.

To enter a hyphen, touch the [Pause] key. To enter a space, touch the [Space] key. To enter "+", press the "[\*]" key.

If you make a mistake, press the [CLEAR] key (C) and re-enter the correct digits.

- 4 Touch the [OK] key.

Return to step 2.

To store another number, repeat steps 2 through 4.

- 5 Touch the [OK] key.

### Deleting a passcode number

- 1 Touch the [Delete] key.
- 2 Touch the key of the number you wish to delete.

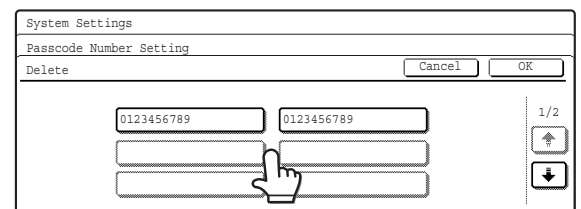

- 3 Touch the [Yes] key.

Return to step 2.

To delete another number, repeat steps 2 and 3.

- 4 Touch the [OK] key.

---

---

# List Print (Administrator)

This is used to print lists and reports that are only for use by the administrator of the machine. Touch the [List Print (Administrator)] key and configure the settings.

---

## Administrator Settings List

Lists of the administrator settings for the following modes can be printed.

- Copy
- Print
- Image Send
- Document Filing
- Security
- Common
- All Administrator Settings List

Touch the desired key. Printing will begin.

---

## Image Sending Activity Report

The following Image Sending Activity Reports can each be separately printed.

- Image Sending Activity Report (Scanner)
- Image Sending Activity Report (Internet Fax)
- Image Sending Activity Report (Fax)

Touch the desired key. Printing will begin.

---

## Anti Junk Fax Number List

**(When the facsimile expansion kit is installed.)**

This prints a list of the Anti Junk fax numbers stored using "[Anti Junk Fax Setting](#)" (page 183) in the system settings for fax (administrator).

---

## Anti Junk Mail/Domain Name List

**(When the Internet Fax expansion kit is installed.)**

This prints a list of the anti junk address/domain names that have been stored using "Anti Junk Mail/Domain Name Setting" in the system settings (administrator).

---

## Inbound Routing List

This prints a list of the "Inbound Routing Settings".

---

## Document Admin List

This prints a list of the "Document Administration Function" settings.

---

## Web Setting List

**(When network connection is enabled.)**

This prints a list of the settings that are configured in the Web pages.

---

## Metadata Set List

**(When the application integration module is installed.)**

This prints a list of the metadata set stored in the Web pages.

---

---

# Enable/Disable Settings

The following settings are used to prohibit the use of certain functions. Touch the [Enable/Disable Settings] key and configure the settings.



The Enable/Disable Settings control the same parameters as other settings such as the Printer Condition Settings. The settings are linked together (changing one setting changes the other).

---

## Image Send Settings

### Disable Switching of Display Order

This is used to prohibit changes to the order of display (order search number, ascending, descending) in the Address Book.

When this setting is enabled, touching a tab on the Address Book screen does not change the order. The currently selected display order will be the order that is used after the setting is selected.

To enable this setting, select the checkbox  and touch the [OK] key.

### Disable Scan Function

This is used to disable PC scan and USB memory scan.

When these modes are disabled, they are grayed out when the mode is selected in the base screen.

Select the checkboxes  of the modes that you wish to disable and touch the [OK] key.

## Settings to Disable the Registration of Destination

This is used to prohibit the storing of destinations. Storing from the machine, storing from the Web page, and storing from a computer can each be separately prohibited.

### Disable Registering Destination from Operation Panel

Disables address control from the machine.

To use this setting, select the desired items  and touch the [OK] key.

- Group
- E-mail
- Internet Fax
- Fax

(When the [Select/Cancel All] key is touched, all settings become . When the key is touched in the condition, all settings become .)

### Disable Registering Destination on Web Page (When network connection is enabled.)

Disable address control from the Web page.

To use this setting, select the checkboxes  of the desired items from the followings and touch the [OK] key.

- Group
- E-mail
- FTP
- Desktop
- Network folder
- Internet Fax
- Fax

(When the [Select/Cancel All] key is touched, all settings become . When the key is touched in the condition, all settings become .)

### Disable Registration Using Network Scan Tools (When network connection is enabled.)

Disable address control from the Network Scanner Tool.

To enable this setting, select the checkbox  and touch the [OK] key.

## Settings to Disable Transmission

These settings are used to disable the following transmission operations.

### Disable [Resend] on Fax/Image Send Mode

Disable the use of the [Resend] key on the basic screen of image send mode.

To enable this setting, select the checkbox  and touch the [OK] key.

### Disable selection from the Address Book

This is used to disable selecting the destination from the Address Book.

To use this setting, select the checkboxes  of the desired items from the followings and touch the [OK] key.

- E-mail
- FTP
- Desktop
- Network Folder
- Internet Fax
- Fax

(When the [Select/Cancel All] key is touched, all settings become . When the key is touched in the condition, all settings become .)

### Disable Direct Entry

This prohibits the direct entry of the address.

To use this setting, select the checkboxes of the desired items from the followings and touch the [OK] key.

- E-mail
- Internet Fax
- Fax

(When the [Select/Cancel All] key is touched, all settings become . When the key is touched in the condition, all settings become .)

### Disable PC-I-Fax Transmission

**(When Internet fax expansion kit is installed.)**

Disable transmission from PC-I-Fax.

To enable this setting, select the checkbox  and touch the [OK] key.

### Disable PC-Fax Transmission

**(When the facsimile expansion kit is installed.)**

Disable transmission from PC-Fax.

To enable this setting, select the checkbox  and touch the [OK] key.

**SHARP**<sup>®</sup>

MODEL: MX-2300N  
MX-2700N

# Document Filing Guide



---

---

# TABLE OF CONTENTS

<b>ABOUT THIS MANUAL</b> .....	<b>2</b>
• MANUALS PROVIDED WITH THE MACHINE ...	2

## **1** DOCUMENT FILING

<b>OVERVIEW</b> .....	<b>4</b>
• TYPES OF DOCUMENT FILING .....	4
• USES OF DOCUMENT FILING .....	5
• BEFORE USING DOCUMENT FILING .....	6
• IMPORTANT POINTS WHEN USING DOCUMENT FILING .....	8
• USING DOCUMENT FILING IN EACH MODE ...	9
<b>BASE SCREEN OF DOCUMENT FILING MODE</b> ...	<b>10</b>

## **2** SAVING FILES WITH DOCUMENT FILING

<b>SAVING A FILE WITH "Quick File"</b> .....	<b>11</b>
<b>SAVING A FILE WITH "File"</b> .....	<b>13</b>
• FILE INFORMATION .....	15
<b>STORING A DOCUMENT ONLY (Scan to HDD)</b> ...	<b>17</b>
• "Scan to HDD" SCREEN .....	17
• PERFORMING "Scan to HDD" .....	17
• ORIGINAL SETTINGS FOR "Scan to HDD" ...	19

## **3** USING STORED FILES

<b>SEQUENCE FOR USING A STORED FILE</b> .....	<b>22</b>
• REGULAR SEQUENCE FOR USING A STORED FILE .....	22
• SEQUENCE FOR USING A STORED FILE WHEN USER AUTHENTICATION IS ENABLED .....	24
<b>FOLDER AND FILE SELECTION SCREENS</b> .....	<b>25</b>
• FOLDER SELECTION SCREEN .....	25
• FILE SELECTION SCREEN .....	26
• JOB SETTINGS SCREEN .....	27
<b>PRINTING A STORED FILE</b> .....	<b>28</b>
• PRINT SETTINGS SCREEN .....	29
• BATCH PRINTING .....	30
<b>SENDING A STORED FILE</b> .....	<b>32</b>
• SEND SETTINGS SCREEN .....	34
<b>PROPERTIES OF STORED FILES</b> .....	<b>35</b>
• FILE PROPERTIES .....	35
• CHANGING THE PROPERTY .....	35
<b>MOVING A STORED FILE</b> .....	<b>37</b>
<b>DELETING A STORED FILE</b> .....	<b>39</b>
<b>CALLING UP AND USING A FILE FROM THE JOB STATUS SCREEN</b> .....	<b>41</b>
<b>SEARCHING FOR A STORED FILE</b> .....	<b>42</b>
• BASIC SEARCH PROCEDURE .....	42

---

---

# ABOUT THIS MANUAL

## Please note

- Considerable care has been taken in preparing this manual. If you have any comments or concerns about the manual, please contact your dealer or nearest SHARP Service Department.
- This product has undergone strict quality control and inspection procedures. In the unlikely event that a defect or other problem is discovered, please contact your dealer or nearest SHARP Service Department.
- Aside from instances provided for by law, SHARP is not responsible for failures occurring during the use of the product or its options, or failures due to incorrect operation of the product and its options, or other failures, or for any damage that occurs due to use of the product.

## Warning

- Reproduction, adaptation or translation of the contents of the manual without prior written permission is prohibited, except as allowed under copyright laws.
- All information included herein is subject to change without notice.

## Illustrations and the operation panel and touch panel in this manual

The peripheral devices are generally optional, however, some models include certain peripheral devices as standard equipment. The explanations in this manual assume that a right tray and stand/2 x 500 sheet paper drawer are installed. To further explain certain functions and uses, some explanations assume that additional peripheral devices are installed.

## Scope of the explanations in this manual

- The explanations of the document filing function assume that the user is already familiar with copy mode, and the other modes of the machine.  
This manual does not contain detailed explanations of the other modes that are used in conjunction with the document filing function.  
If you have any questions regarding one of the other modes, see the manual for that mode.
- To further explain certain functions and uses, some explanations assume that additional peripheral devices (Internet fax expansion kit etc.) are installed.  
The function that cannot be used according to the state of the installation of the peripheral devices is provided.

The display screens, messages, and key names shown in the manual may differ from those on the actual machine due to product improvements and modifications.

# MANUALS PROVIDED WITH THE MACHINE

Printed manuals and manuals stored in PDF format on the machine's hard drive are provided with the machine. When using the machine, read the appropriate manual for the feature you are using.

## Printed manuals

Manual name	Contents
<b>Safety Guide</b>	This manual contains instructions for using the machine safely and lists the specifications of the machine and its peripheral devices.
<b>Software Setup Guide</b>	This manual explains how to install the software and configure settings to use the machine as a printer or scanner.
<b>Quick Start Guide</b>	This manual provides easy-to-understand explanations of all the functions of the machine in a single volume. Detailed explanations of each of the functions can be found in the manuals in PDF format.
<b>Troubleshooting</b>	This manual explains how to remove paper misfeeds and provides answers to frequently asked questions regarding the operation of the machine in each mode. Refer to this manual when you have difficulty using the machine.
<b>Facsimile Quick Reference Guide</b>	This manual explains the basic procedures for using the fax function of the machine, and provides an overview of the features of the fax function, troubleshooting procedures, and specifications. For detailed information on using the fax function and the system settings for fax, see the "Facsimile Guide" in PDF format.





## Operation manuals in PDF format

The manuals in PDF format provide detailed explanations of the procedures for using the machine in each mode. To view the PDF manuals, download them from the hard drive in the machine. The procedure for downloading the manuals is explained in "How to download the manuals in PDF format" in the Quick Start Guide.

Manual name	Contents
<b>User's Guide</b>	This manual provides information, such as basic operation procedures, how to load paper, and machine maintenance.
<b>Copier Guide</b>	This manual provides detailed explanations of the procedures for using the copy function.
<b>Printer Guide</b>	This manual provides detailed explanations of the procedures for using the printer function.
<b>Facsimile Guide</b>	This manual provides detailed explanations of the procedures for using the fax function and the "System Settings" that are related to fax.
<b>Scanner Guide</b>	This manual provides detailed explanations of the procedures for using the scanner function and the Internet Fax function.
<b>Document Filing Guide (This manual)</b>	This manual provides detailed explanations of the procedures for using the document filing function. The document filing function allows you to save the document data of a copy or fax job, or the data of a print job, as a file on the machine's hard drive. The file can be called up as needed.
<b>System Settings Guide</b>	This manual explains the "System Settings", which are used to configure a variety of parameters to suit the aims and the needs of your workplace. Current settings can be displayed or printed out from the "System Settings".

## Icons used in the manuals

The icons in the manuals indicate the following types of information:

	This alerts you to a situation where there is a risk of machine damage or failure.		<p>This indicates the name of a system setting and a provides a brief explanation of the setting. For detailed information on each system setting, see the System Settings Guide.</p> <p><b>When "System Settings:" appears</b> A general setting is explained.</p> <p><b>When "System Settings (Administrator):" appears</b> A setting that can only be configured by an administrator is explained.</p>
	This provides a supplemental explanation of a function or procedure.		
	This explains how to cancel or correct an operation.		



# 1

# DOCUMENT FILING

This chapter provides information that you should know before using the document filing function, including an overview of document filing, the features and functions of document filing, and points to keep in mind when using document filing.

## OVERVIEW

The document filing function allows you to save the document image of a copy or fax transmission job, or the data of a print job, as a file on the machine's hard drive.

The saved file can be called up and printed or transmitted as needed.

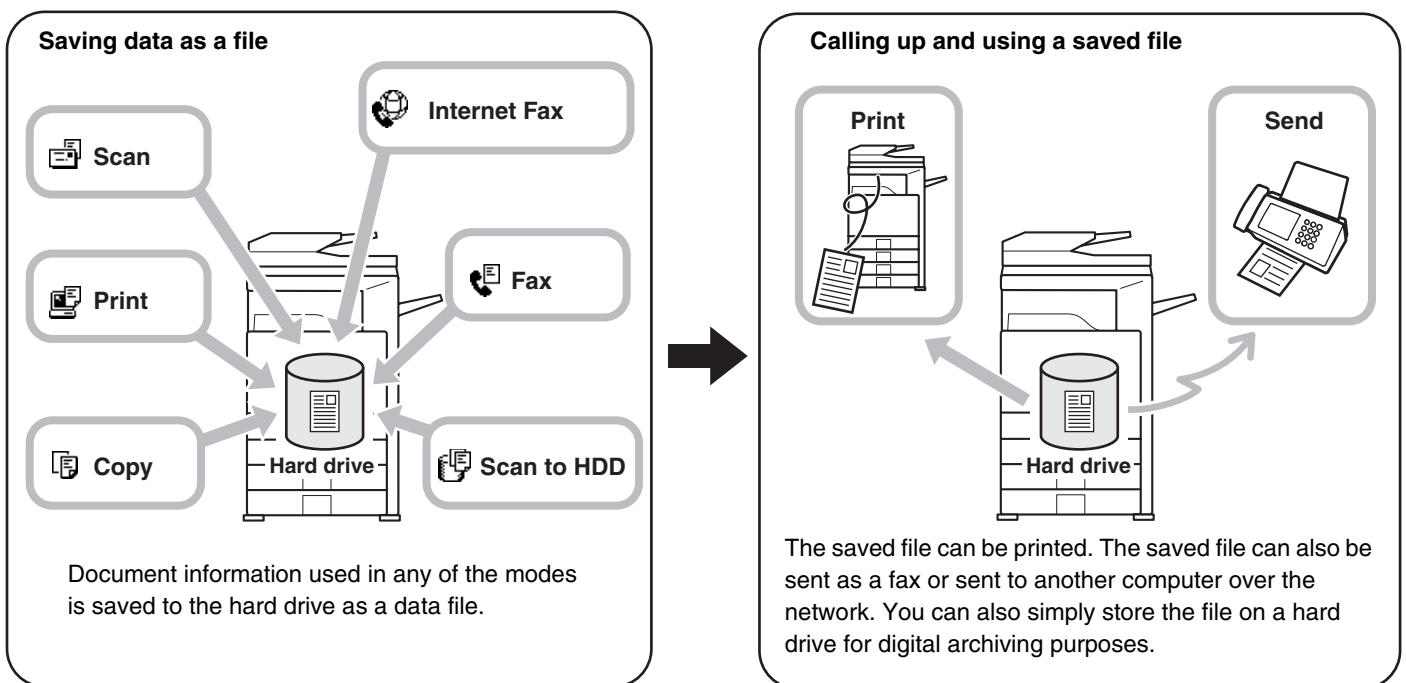

## TYPES OF DOCUMENT FILING

There are three ways to save a file using document filing: "Quick File", "File", and "Scan to HDD".

<b>Quick File</b>	Use this method to conveniently save the document image of a copy or scan job, or the data of a print job. The file can be saved quickly and easily because no settings are required. The saved file can also be used by other people. Do not use this method to save files containing sensitive or confidential information, or files that you do not want others to use.
<b>File</b>	Use this method to conveniently save the document image of a copy or scan job, or the data of a print job. Unlike Quick File, the File function allows you to append various types of information when saving the file. The appended information allows efficient management of the file. A password can also be established to prevent the file from being called up by others.
<b>Scan to HDD</b>	Use this function to simply store a document. This is a feature of the File function. The other document filing methods save a copy, scanner, or other job as a file on the hard drive when the corresponding function operates. Use Scan to HDD when you simply want to save a document to the hard drive.

# USES OF DOCUMENT FILING

Several examples of how document filing can be used are provided below.

## Quickly using a file

**Example:** You prepared handouts consisting of numerous pages for a meeting, however, another handout is needed for a newly added participant.

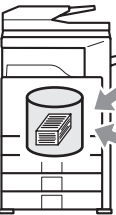
The handout was not saved using document filing	The handout was saved using document filing
 <p>All the numerous original pages must be scanned again.</p> <p>Settings for job build, the ratio, and the color mode must all be selected again.</p> <p>Time required for selecting settings + Time required for scanning the original + Time required for printing the copies</p> <p style="text-align: center;">↓</p> <p>Not likely to be completed in time for the meeting...</p>	 <p>The scanned original pages are stored on the hard drive. The file can be called up at any time.</p> <p>The settings selected at the time of copying are also stored. No need to redo the settings.</p> <p>Time required to call up the stored job + Time required to print the copies</p> <p style="text-align: center;">↓</p> <p>Printing is accomplished quickly and the handout is ready in time for the meeting!</p>
<p>As indicated above, to obtain another set of output, the settings must be selected all over again. If you don't remember the settings, much effort may be expended to get the same output result as the previous time.</p>	<p>The job can be called up and printed using the same settings quickly and easily.</p>

As shown in the example, storing a job with the document filing function frees you of the need to rescan the original and select settings, saving considerable time.

## Convenient for managing frequently used documents

**Example:** Managing a large number of business forms

### Not using document filing

It takes time to find the form you need.



### Using document filing

The desired form can be selected from the document filing list with ease, and document management is efficient.

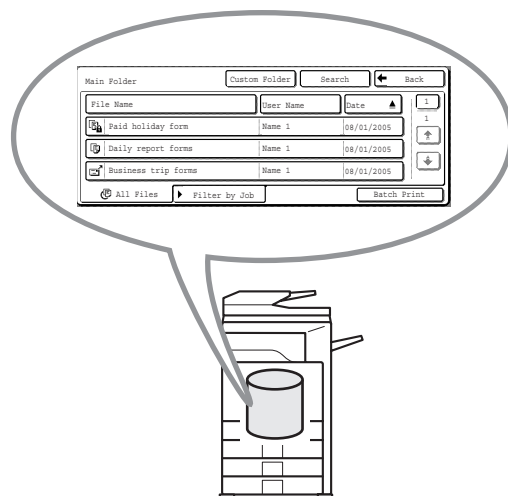

Application forms, report forms, and other business forms can be stored on the hard drive for easy retrieval, letting you print the number of copies you need when you need them.

# BEFORE USING DOCUMENT FILING

Before using File, it is convenient to create user names and Custom Folders. If user authorization is used, it is convenient to create My Folder.

The user name, Custom Folders, and My Folder are created in the system settings.

<b>User Name</b>	The user name is configured in "User Registration" in the system settings (administrator).
<b>Custom Folder</b>	Custom Folders are created in "Document Filing Control" in the system settings. A password can be established when a Custom Folder is created. A password can be established for a Custom Folder. When this is done, a password entry screen will appear whenever the Custom Folder is selected or the Custom Folder is deleted or amended. This is convenient for saving sensitive information.
<b>My Folder</b>	My Folder is configured in "User Registration" in the system settings (administrator). When user authentication is enabled and a file is saved using the File function, the Custom Folder specified as My Folder is automatically selected.



## System Settings (Administrator): User Registration

This is used to store a user name and specify a folder as My Folder.

## System Settings: Document Filing Control

This is used to create Custom Folders for document filing. A password can be established when a Custom Folder is created.

## Folders

Three types of folders are used to store files using document filing.

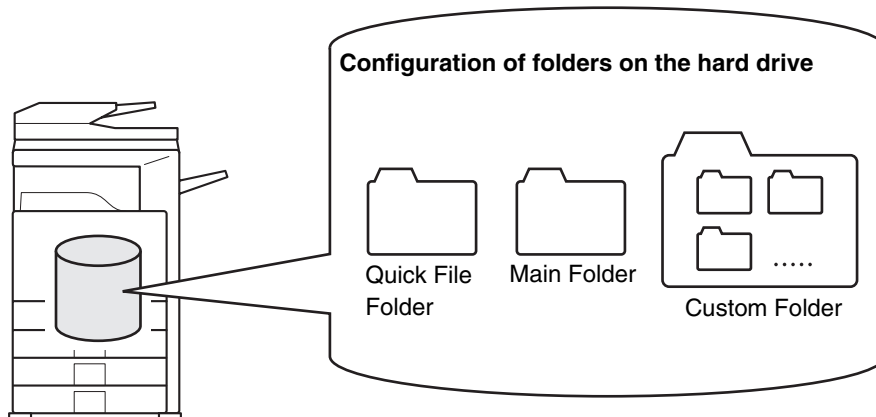

### Quick File Folder

A document saved using the [Quick File] key is stored in this folder. A user name and file name are automatically assigned to the job.

### Main Folder

Documents scanned using the [File] key are stored in this folder.

When you store a job in the Main Folder, you can specify a previously stored user name and assign a file name.

A password can also be set when saving a file ([Confidential] save).

### Custom Folder

Folders with custom names can be created inside this folder.

When a Custom Folder is specified before touching the [File] key, the document is scanned into that folder.

Like the Main Folder, a Custom Folder allows you to specify a previously stored user name and assign a file name when storing a job.



Passwords can be set for Custom Folders and for files saved in Custom Folders.



A maximum of 500 Custom Folders can be created on the hard drive.

# Approximate number of pages and files that can be stored by document filing

## Examples of original types

Color	Full color original (Example: text and photo)	 Size: 8-1/2" x 11" (A4)
Black and white	Text original	 Size: 8-1/2" x 11" (A4)

- A combined maximum of 1400 1-sided pages in black and white or 400 1-sided pages in color (for the above examples) can be stored in the main and Custom Folders. However, for the above black and white originals, the maximum number of files that can be stored is 1000.
- The above maximums also apply to the Quick File Folder. However, note that the memory area used by the Quick File Folder is also used by the electronic sort function of copy mode. If unneeded files accumulate in the Quick File Folder and the folder becomes full, electronic sorting will be affected when a large number of originals are sorted. Be sure to delete unneeded files.

The original types above are examples to make the explanation easier to understand. The actual number of pages that can be stored will vary depending on the contents of the original images.

## Files

When a file is saved using "File", the following information can be appended.

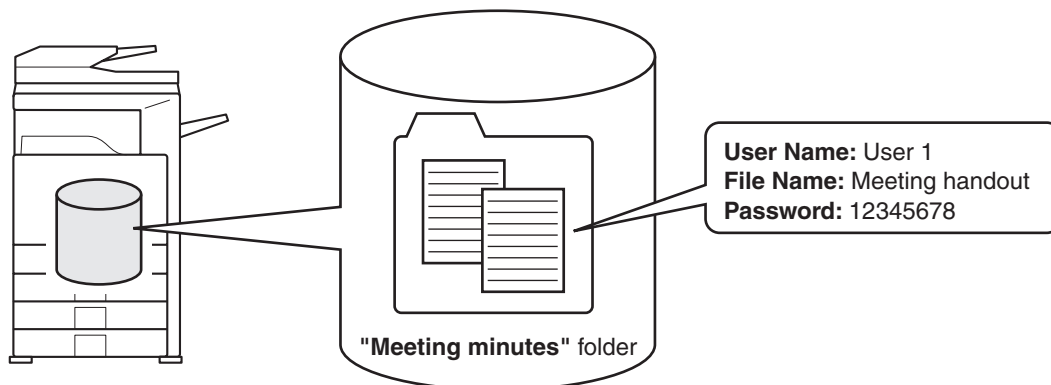

Saving a file with this information allows you to distinguish it from other files.

**User Name:** Use this to specify the owner of the file. The user name must first be stored in "User registration" in the system settings (administrator).

**File Name:** A file name can be entered.

**Folder:** Select which folder the file will be saved in.

**Confidential:** A password from 5 to 8 digits can be established to prevent others from using the file.



The above information cannot be specified when a file is saved with Quick File.



### System Settings (Administrator): User Registration

This is used to store user names.

# IMPORTANT POINTS WHEN USING DOCUMENT FILING

Note the following when using document filing:

- Documents saved with [Quick File] are "Sharing" files that can be called up by anyone and printed or transmitted. For this reason, do not use Quick File for sensitive documents or documents that you do not want to be used by others.
- When saving a file with "File", if you wish to prevent others from using the file, specify "Confidential" to enable the use of a password. When a file is saved as a "Confidential" file, take care not to disclose the password to others.
- Even when a file is saved with the [Confidential] property, the property can be changed afterward to [Sharing]. For this reason, do not save sensitive documents or documents that you do not want to be reused by others.
- Except in cases provided for by law, SHARP Corporation bears no responsibility for any damages that result from the leaking of sensitive information due to manipulation by a third party of any data saved using the Quick File function or File function, or incorrect operation of the Quick File function or filing function by the operator that saves the data.

# USING DOCUMENT FILING IN EACH MODE

In copy, fax, or image send mode, the original can be saved as an image file on the hard drive at the same time it is copied or transmitted. In scan to HDD mode, the original can be stored as a file on the hard drive without being copied or transmitted.

## Copy mode

The original is saved as an image file at the same time it is copied.

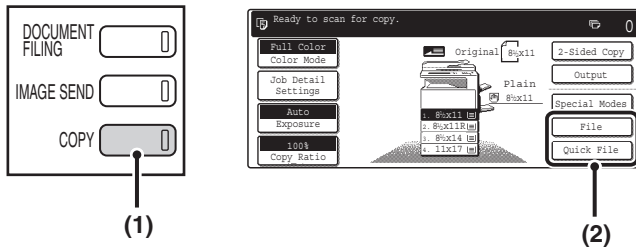

- (1) Press the [COPY] key.
- (2) Touch the [Quick File] key or the [File] key.

## Image send mode

### Example: Base screen of scan mode

The original is saved as an image file at the same time it is scanned.

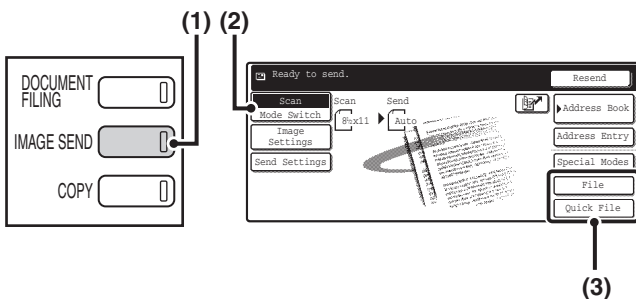

- (1) Press the [IMAGE SEND] key.
- (2) Touch the [Mode Switch] key.  
This allows you to select fax mode, scan mode, and Internet fax mode.
- (3) Touch the [Quick File] key or the [File] key.

## Scan to HDD mode

The scanned original is saved as an image file. Neither printing nor transmission are performed when Scan to HDD is used.

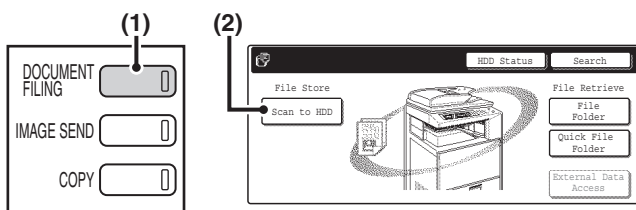

- (1) Press the [DOCUMENT FILING] key.
- (2) Touch the [Scan to HDD] key.

 **[File] key and [Quick File] key**  
If the [File] key and the [Quick File] key do not appear in the base screens of each mode, the screen display has been changed using "Customize Key Setting" in the system settings (administrator). In this case, follow these steps to perform document filing:

- Touch the [Job Detail Settings] key or [Image Settings] key and then touch the [Special Modes] key in the screen that appears. The [Quick File] key and the [File] key will appear in the special modes menu.
- If the [Special Modes] key appears in the screen, touch the key to display the [Quick File] key and the [File] key.

**Using document filing in print mode**  
To use document filing in print mode, select document filing in the printer driver. For more information on using document filing in print mode, see "CONVENIENT PRINTER FUNCTIONS" in the Printer Guide.

**Using document filing in PC-Fax/PC-I-Fax mode**  
To use document filing in PC-Fax or PC-I-Fax mode, select document filing settings in the PC-Fax driver. For more information, see Help in the PC-Fax driver.

# BASE SCREEN OF DOCUMENT FILING MODE

When the [DOCUMENT FILING] key is pressed on the operation panel, the following screen appears. This screen is used to call up and use image files saved during copying or scanning.

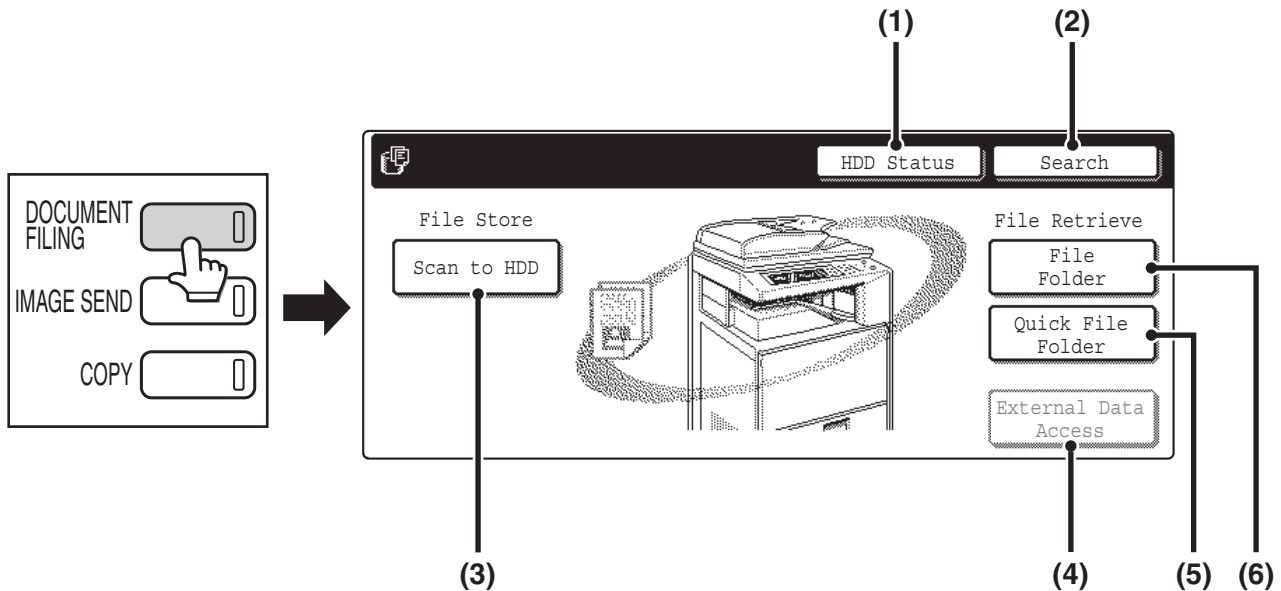

**(1) [HDD Status] key**

Touch this key to check how much of the machine's hard drive is being used. The amount of disk space used is shown in increments of 1%.

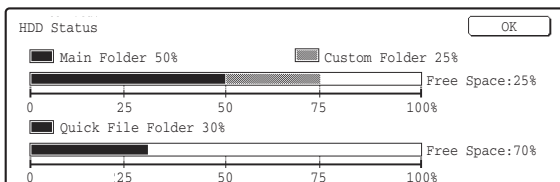

**(2) [Search] key**

Touch this key to search for a file stored in a folder. You can search using the user name, file name, or folder name.

➤ [SEARCHING FOR A STORED FILE](#) (page 42)

**(3) [Scan to HDD] key**

Touch this key to select Scan to HDD. Neither printing nor transmission are performed. The file will be stored in the Main Folder or a custom folder.

➤ [STORING A DOCUMENT ONLY \(Scan to HDD\)](#) (page 17)

**(4) [External Data Access] key**

This can be selected when an FTP server is stored or a USB memory device is connected to the machine. The same screen appears if the [DOCUMENT FILING] key is pressed twice.

➤ "DIRECTLY PRINTING FROM THE MACHINE" in the Printer Guide

**(5) [Quick File Folder] key**

Touch this key to call up a file from the Quick File Folder. When this key is touched, the file selection screen for the Quick File Folder appears.

➤ [SAVING A FILE WITH "Quick File"](#) (page 11)

**(6) [File Folder] key**

Touch this key to call up a file from the Main Folder or a Custom Folder. When this key is touched, the file selection screen of the Main Folder or one of the Custom Folders appears.

When user authentication is used and My Folder is configured, the file selection screen of My Folder will appear.

➤ [SAVING A FILE WITH "File"](#) (page 13)

# 2

## SAVING FILES WITH DOCUMENT FILING

This chapter explains how to save an original as a image file using the Quick File, File, and Scan to HDD functions of document filing mode.

### SAVING A FILE WITH "Quick File"

When copying, printing or transmitting a document in copy mode, print mode, or image send mode, "Quick File" can be selected to save an image of the document to the Quick File Folder.

The image can be called up at a later time, allowing you to print or transmit the document without having to locate the original.

As an example, the procedure for storing a document in the Quick File Folder while copying is explained below.

1

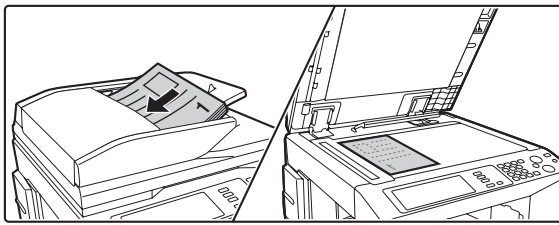

#### Place the original.

Place the original face up in the document feeder tray, or face down on the document glass.

2

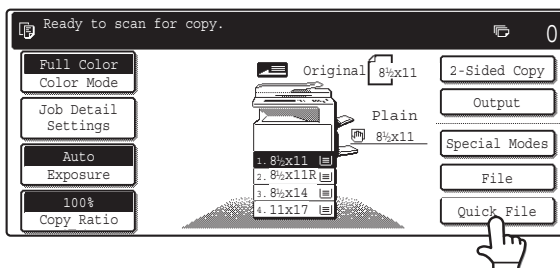

#### Touch the [Quick File] key.

3

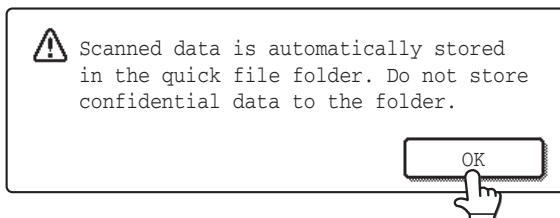

#### Touch the [OK] key.

The [Quick File] key is highlighted and you return to the base screen of copy mode.



#### To cancel Quick File...

Touch the [Quick File] key in the screen of step 2 so that it is not highlighted after you touch the [OK] key.





or



**Select copy settings and then press the [COLOR START] key (○●●●) or the [BLACK & WHITE START] key (○●).**

- When copying begins, the scanned document image is saved to the hard drive.  
The selected copy settings are also saved.
- To prevent accidental saving of the document, "The scanned data is stored in the quick file folder." appears as a message for 6 seconds after the [START] key is pressed.  
The 6-second message display time can be changed using "Message Time Setting" in the system settings (administrator).
- If you inserted the original pages in the document feeder tray, all pages are scanned.
- If you placed the original on the document glass, scan each page one page at a time.  
When scanning of one page finishes, replace it with the next page and press the [START] key.  
Repeat until all pages have been scanned and then press the [Read-End] key.



**To cancel scanning...**

Press the [STOP] key (⊘).



- When a file is stored using Quick File, the following user name and file name are automatically assigned to the file.  
User Name: User Unknown  
File Name: Mode\_Month-Day-Year\_Hour-Minute-Second  
(Example: Copy\_08012005\_134050PM)  
Stored to: Quick File Folder
- When user authentication is used, the user name that was used for login is automatically selected.
- Only the file name and location of a file stored in the Quick File Folder can be changed.



**To cancel Quick File...**

Touch the [Quick File] key in the screen of step 2.

# SAVING A FILE WITH "File"

When copying, printing, or transmitting a document in copy mode, print mode, or image send mode, "File" can be selected to save an image of the document to the Main Folder or a previously created Custom Folder. The image can be called up at a later time, allowing you to print or transmit the document without having to locate the original. As an example, the procedure for using "File" while copying is explained below.

1

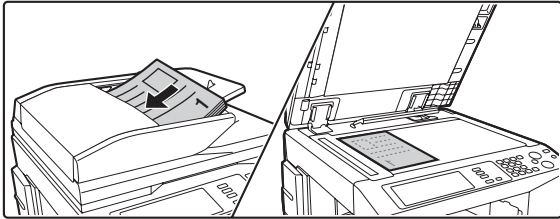

## Place the original.

Place the original face up in the document feeder tray, or face down on the document glass.

2

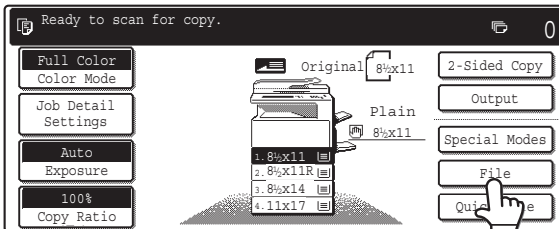

## Touch the [File] key.

3

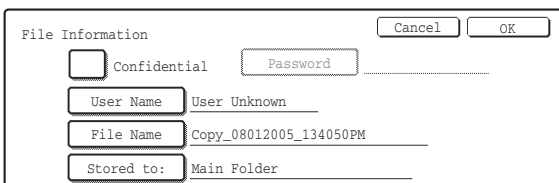

## Configure the file information settings.

To select the user name, file name, folder, and confidential setting, see "FILE INFORMATION" (page 15).

[Specifying a user name:](#) page 15

[Assigning a file name:](#) page 15

[Specifying a folder:](#) page 16

[Storing a file as a confidential file:](#) page 16

After configuring the above settings, you will return to this screen. Go to the next step.

If you do not wish to assign a user name or other information to the file, go to the next step.

4

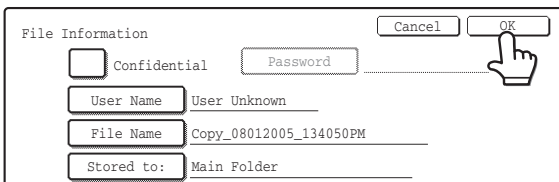

## Touch the [OK] key.

The [File] key is highlighted and you return to the base screen of copy mode.



or



**Select copy settings and then press the [COLOR START] key (○●●●) or the [BLACK & WHITE START] key (○●).**

- When copying begins, the scanned document image is saved to the hard drive.  
The selected copy settings are also saved.
- If you inserted the original pages in the document feeder tray, all pages are scanned.
- If you placed the original on the document glass, scan each page one page at a time.  
When scanning of one page finishes, replace it with the next page and press the [START] key.  
Repeat until all pages have been scanned and then press the [Read-End] key.



**To cancel scanning...**

Press the [STOP] key (⏹).



When a file is stored using File without appending file information, the following user name and file name are automatically assigned to the file.

User Name: User Unknown

File Name: Mode\_Month-Day-Year\_Hour-Minute-Second

(Example: Copy\_08012005\_134050PM)

Stored to: Main Folder

When user authentication is used, the user name that was used for login is automatically selected.



**To cancel the File operation...**

Touch the [Cancel] key in the screen of step 3.

# FILE INFORMATION

This section explains the settings that are configured in step 3 of "SAVING A FILE WITH "File"" (page 13). Specifying a user name, file name, folder, and confidential setting makes it easier to manage and search for files. In addition, when confidential is selected and a password is established, other people will not be able to view the file without permission.

## Specifying a user name

1

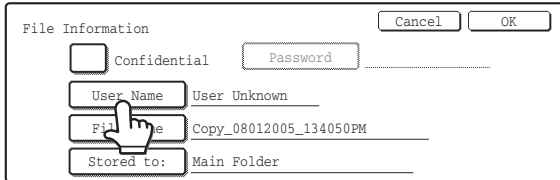

### Touch the [User Name] key.

When user authentication is used, the user name that was used for login is automatically selected. In this case, this step is not needed.



The user name must have been previously stored in "User Registration" in the system settings (administrator).

2

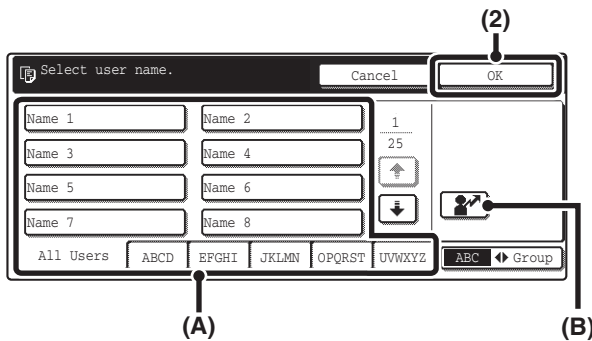

### Touch the desired user name in the list of user names that is displayed.

#### (1) Touch a user name.

There are 2 ways to select the user name:

##### (A) Touch the one-touch key of the user name.

The touched user name is highlighted.

If you accidentally select the wrong user name, touch the key of the correct name.

##### (B) Touch key.

An area [---] for directly entering a registration number will appear at the top of the key. The user name can be selected by entering "Registration No." that was configured when the user was stored.

#### (2) Touch the [OK] key.

The user name that you touched is selected and you return to the screen of step 1. The selected user name appears.

## Assigning a file name

A file name can be assigned to the file.

1

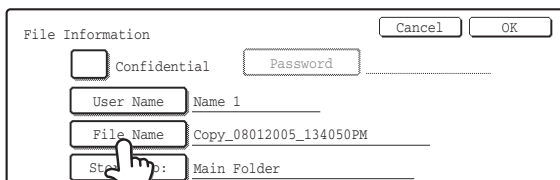

### Touch the [File Name] key.

A text entry screen appears.

Enter the file name in the text entry screen and touch the [OK] key.

A maximum of 30 characters can be entered.

To enter text, see "6. ENTERING TEXT" in the User's Guide.

## Specifying a folder

1

Touch the [Stored To:] key.



When user authentication is used, My Folder appears. If My Folder is not specified for the user that logged in, the Main Folder will appear.

2

Touch the key of the Custom Folder where you wish to store the file.

If a password has been set for the Custom Folder, a password entry screen will appear. Enter the 5- to 8-digit password for the folder with the numeric keys and touch the [OK] key.

## Storing a file as a confidential file

A password can be set for the file to prevent others from viewing it. The password must be a 5- to 8-digit number.

1

Enable the confidential property.

(1) Select the [Confidential] checkbox so that a checkmark  appears.

Confidential mode is enabled and a password can be entered.

(2) Touch the [Password] key.

2

Enter a password (5 to 8 digits) with the numeric keys and touch the [OK] key.

As each digit is entered, "-" changes to "✱".

# STORING A DOCUMENT ONLY (Scan to HDD)

Scan to HDD is used to store the image file of a scanned document in the Main Folder or a Custom Folder. Neither printing nor transmission are performed.

## "Scan to HDD" SCREEN

The following screen appears when the [Scan to HDD] key is touched in the base screen of document filing mode. Touch the keys described below as needed to select Scan to HDD settings.

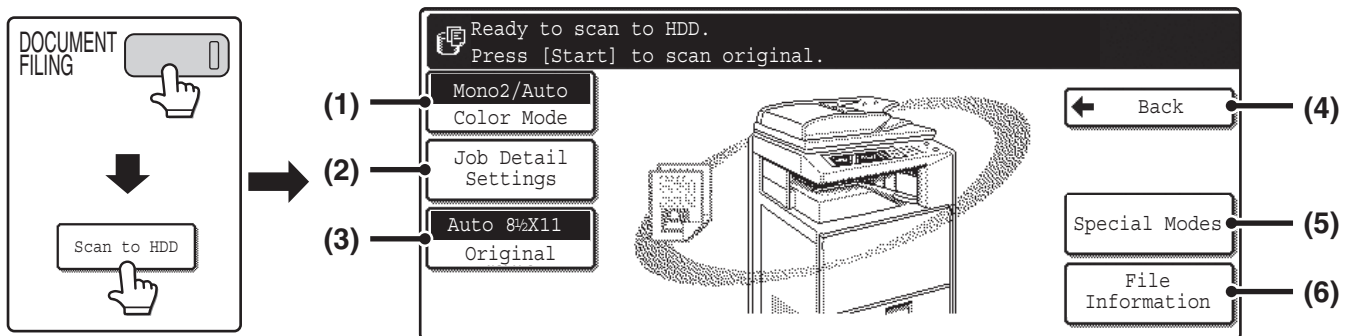

### (1) [Color] key

Use this key to select the color mode when storing the document.

➤ [ORIGINAL SETTINGS FOR "Scan to HDD"](#) (page 19)

### (2) [Job Detail Settings] key

Touch this key to select the exposure, resolution, and compression ratio.

➤ [ORIGINAL SETTINGS FOR "Scan to HDD"](#) (page 19)

### (3) [Original] key

Touch this key to set the original size and select two-sided document scanning. The automatically detected original size appears in the top half of the [Original] key.

➤ [Selecting the original size and two-sided document scanning](#) (page 21)

### (4) [Back] key

Touch this key to return to the base screen of document filing mode.

### (5) [Special Modes] key

Select special modes for Scan to HDD, including erase, dual page scan, and card shot.

➤ [Special modes screen for Scan to HDD](#) (page 21)

### (6) [File Information] key

Touch this key to append information to the file. The settings are configured in the same way as file information for "File".

➤ [FILE INFORMATION](#) (page 15)

## PERFORMING "Scan to HDD"

1

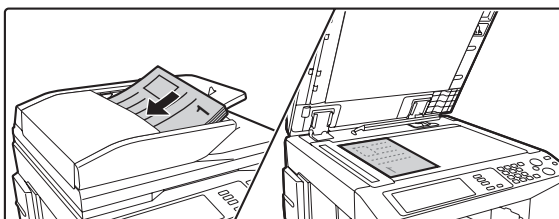

### Place the original.

Place the original face up in the document feeder tray, or face down on the document glass.

2



Press the [DOCUMENT FILING] key.

3

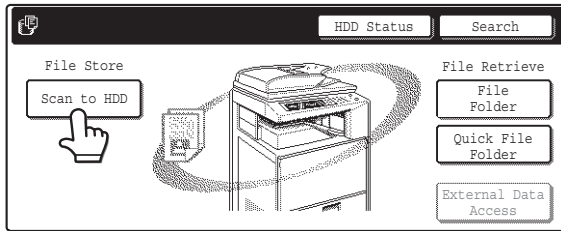

Touch the [Scan to HDD] key.

4

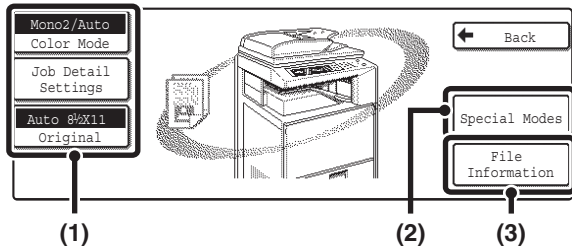

Select Scan to HDD settings.

If you do not wish to select settings, go to the next step.

(1) Select the color mode, job detail settings, and the original size.

See "ORIGINAL SETTINGS FOR "Scan to HDD"" (page 19).

(2) Touch the [Special Modes] key.

See "Special modes screen for Scan to HDD" (page 21).

(3) Touch the [File Information] key.

The settings are the same as for "File". See "FILE INFORMATION" (page 15).



If the original is 2-sided, be sure to touch the [Original] key and then touch the [2-Sided Booklet] key or the [2-Sided Tablet] key as appropriate for the original.

5

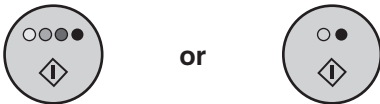

Press the [COLOR START] key (○●●●) or the [BLACK & WHITE START] key (○●).

Scanning begins.

- If you inserted the original pages in the document feeder tray, all pages are scanned. A beep will sound to indicate that Scan to HDD is completed.
- If you placed the original on the document glass, scan each page one page at a time. When scanning of one page finishes, replace it with the next page and press the [START] key. Repeat until all pages have been scanned and then press the [Read-End] key. A beep will sound to indicate that Scan to HDD is completed.



To cancel scanning... Press the [STOP] key (⊘).

# ORIGINAL SETTINGS FOR "Scan to HDD"

Settings for Scan to HDD are described below.

## [Color Mode] key

Touch the [Color Mode] key to open the color mode setting screen for Scan to HDD.

When you have finished selecting the color mode, touch the [OK] key.

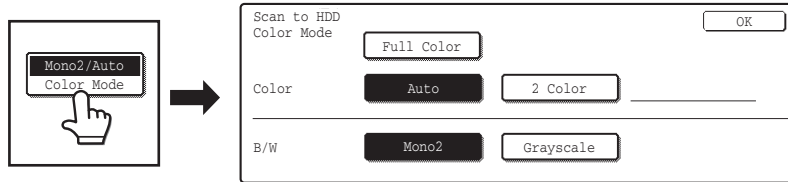

The following settings can be selected for the scanning color when the [COLOR START] key (○●●●) or the [BLACK & WHITE START] key (○●) is pressed.

Start key	Mode	Scanning method
[COLOR START] key	Full Color	The original is scanned in full color. This mode is best for full color originals such as catalogues. Even when the original is black and white, it is scanned as a full color original.
	Auto	The machine detects whether the original is color or black and white and automatically selects full color or black and white (grayscale) scanning.
	2 Color	Only the red areas of the original are changed to the selected color; colors other than red are scanned in black. Red, green, blue, cyan, magenta, or yellow can be selected.
[BLACK & WHITE START] key	Mono 2	Colors in the original are scanned in black and white. This mode is best for text-only originals.
	Grayscale	The colors in the original are scanned in black and white as shades of gray (grayscale).

## [Job Detail Settings] key

Touch the [Job Detail Settings] key to display the [Exposure] key, [Resolution] key, and [Comp. Ratio] key.

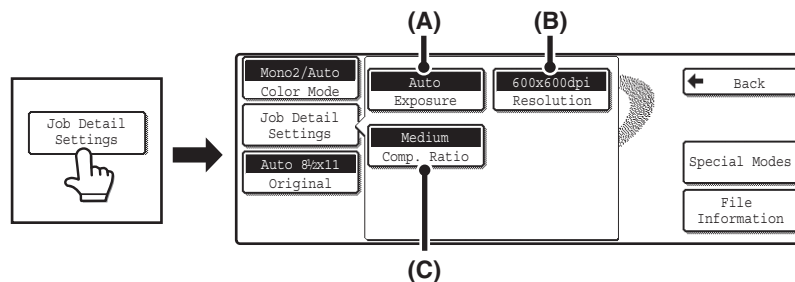

### (A) [Exposure] key

Use this to adjust the exposure and exposure mode.

### (B) [Resolution] key

Use this to select the resolution that will be used when the file is transmitted.



### (C) [Comp. Ratio] key

Use this to select the color compression ratio that will be used when the file is transmitted in color.



## Exposure adjustment

To adjust the exposure and select the exposure mode, touch the [Exposure] key.



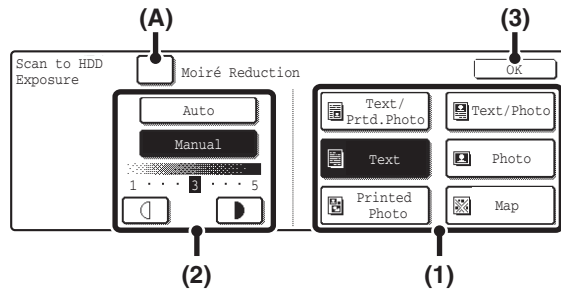

Select an appropriate exposure mode for the original and touch the  or  key to adjust the exposure level. After selecting the settings, touch the [OK] key.





### (1) Select the appropriate exposure mode for the original type.

Touch the appropriate original type key to select the exposure mode.

### (2) Select [Auto] or [Manual].

If you selected [Manual], touch the  or  key to adjust the exposure. (For a darker image, touch the  key. For a lighter image, touch the  key.)

When the exposure is set to [Auto], the exposure modes [Photo], [Printed Photo], and [Map] do not appear. In addition, the   keys cannot be used.

#### (A): Moiré Reduction

To reduce the moire effect when scanning printed matter, touch the [Moiré Reduction] checkbox so that a checkmark  appears.

### (3) Touch the [OK] key.

The settings are stored and you return to the Scan to HDD screen.

## [Original] key

### Selecting the original size and two-sided document scanning

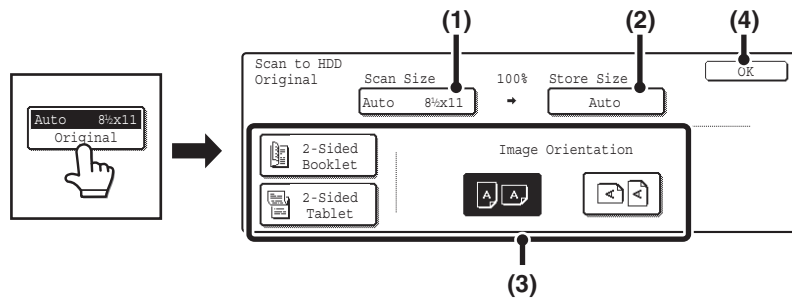



#### (1) Touch the [Scan Size] key.

If the original is a non-standard size that cannot be detected by auto original size detection, touch the [Scan Size] key and specify the original size.

#### (2) Touch the [Store Size] key.

If you wish to store the file at a different size than the original size, touch the [Store Size] key and change the store size.

#### (3) Touch the appropriate orientation key.

If the top edge of the original is up, touch the  key. If the top edge of the original is to the left, touch the  key.

If the original is a 2-sided original, touch the [2-Sided Booklet] key or the [2-Sided Tablet] key as appropriate for the original type.

#### (4) Touch the [OK] key.

## Special modes screen for Scan to HDD

When the [Special Modes] key is touched, the following screen appears. For more information on each setting, see "7. CONVENIENT FUNCTIONS" in the Scanner Guide.

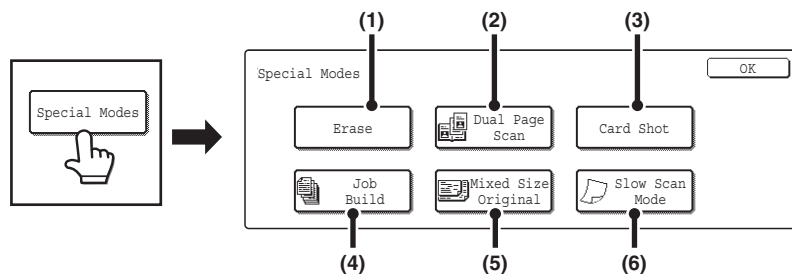

#### (1) [Erase] key

This prevents shadows in scanned images. The erase function is used to erase shadows at the edges of images that occur when scanning thick originals or books.

#### (2) [Dual Page Scan] key

This divides an original into two pages. The left and right sides of a single original are scanned as two separate pages. This function is useful when you wish to separately scan each page of a book or other bound document.

#### (3) [Card Shot] key

This scans the front and reverse sides of a card together. This function is useful when you wish to separately scan each page of a book or other bound document.

#### (4) [Job Build] key

This is used to scan a large number of originals into a single file. When the number of originals that you wish to scan exceeds the number of sheets that can be placed in the automatic document feeder, this function lets you scan the originals in sets and store them in a single file.

#### (5) [Mixed Size Original] key

Use this function when you wish to scan originals of mixed sizes using the automatic document feeder. This feature lets you scan originals of different sizes at the same time; for example, 8-1/2" x 14" (B4) size originals mixed together with 11" x 17" (A3) size originals.

Originals of different widths and sizes (11" x 17" and 8-1/2" x 11", 11" x 17" and 8-1/2" x 13", 11" x 17" and 5-1/2" x 8-1/2", 8-1/2" x 14" and 8-1/2" x 11", 8-1/2" x 14" and 5-1/2" x 8-1/2", 8-1/2" x 11" and 5-1/2" x 8-1/2" (A3 and B4, A3 and B5, A4 and B4, A4 and B5, B4 and A4R, B4 and A5, B5 and A4R, B5 and A5)) can be scanned.

#### (6) [Slow Scan Mode] key

Use this function when you wish to scan thin originals using the automatic document feeder. This function helps prevent thin originals from misfeeding.

# 3 USING STORED FILES

This chapter explains how to call up a file stored by document filing and print or transmit the file.

---

---

## SEQUENCE FOR USING A STORED FILE

The basic procedure for calling up and using a stored file is explained here. The procedures and displayed screens vary depending on whether or not user authentication is enabled.

See the sequence that applies to your situation.

For information on user authentication procedures, see "USER AUTHENTICATION" in the User's Guide. For information on enabling user authentication and storing user names, see "User Control" in the System Settings Guide.

 Files stored by document filing can also be called up and used from the Web pages. Clicking [Document Operation] and then [Document Filing] in the Web page menu, and then select the folder that contains the file you wish to use.

## REGULAR SEQUENCE FOR USING A STORED FILE

Follow the steps below to call up and use a stored file.

Press the [DOCUMENT FILING] key.



Touch the [File Folder] key.

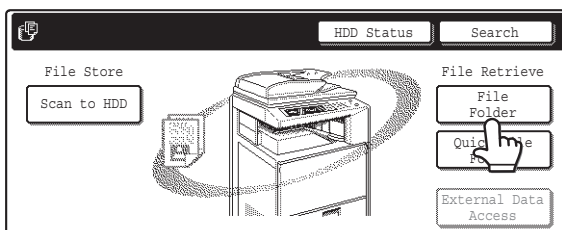

- If you were using a file in a Custom Folder before opening the file or folder selection screen, the folder selection screen will appear.
- If you were using a file in the Main Folder before opening the file or folder selection screen, the file selection screen of the Main Folder will appear.



## Touch the key of the folder that contains the desired file.

### Example: Searching from a Custom Folder

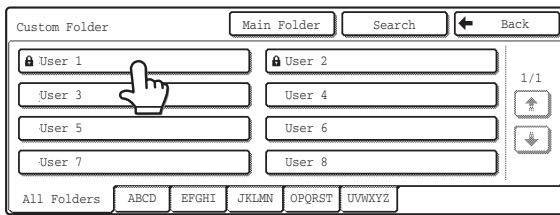

- To display the file selection screen of the Main Folder, touch the [Main Folder] key.
- If you touch a folder key that has a password, a password entry screen appears. Enter the password (5 to 8 digits) for the folder with the numeric keys.



## Touch the key of the file that you wish to use.

### Example: Searching all jobs

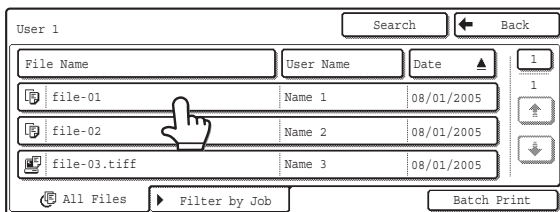

- To search by job type, touch the [Filter by Job] tab.
- Mode keys (copy mode, scan mode, etc.) appear on the [Filter by Job] tab to let you restrict the search to jobs of a selected mode.
- If you touch a file key that has a password, a password entry screen appears. Enter the password (5 to 8 digits) for the file with the numeric keys.



## Touch the key of the operation that you wish to perform.

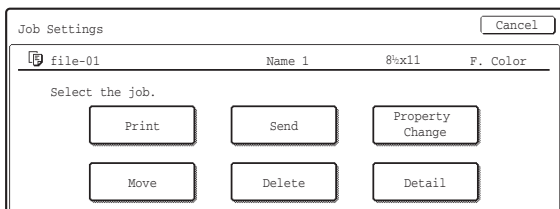

- For detailed information on each key, see "[JOB SETTINGS SCREEN](#)" (page 27).

# SEQUENCE FOR USING A STORED FILE WHEN USER AUTHENTICATION IS ENABLED

The following explanation assumes that the user has already logged in using a user number or login name and password. The explanation also assumes that "My Folder" was specified when the "User Registration" settings were configured in the system settings (administrator).

Press the [DOCUMENT FILING] key.



Touch the [File Folder] key.

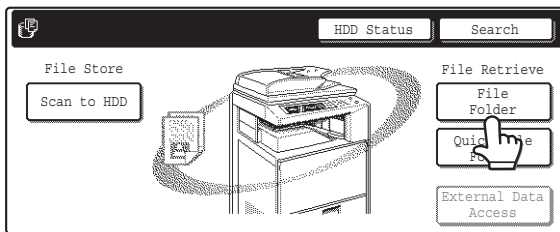

- If "My Folder" was specified when "User Registration" was configured in the system settings (administrator), the file selection screen of the Custom Folder specified as "My Folder" appears.
- If "My Folder" was not specified, the folder selection screen appears.



Touch the key of the file that you wish to use.

Example: "User 1" folder is specified as "My Folder".

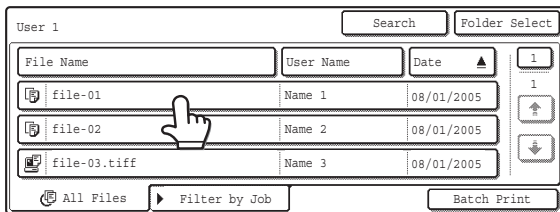

- To search by job type, touch the [Filter by Job] tab.
- Mode keys (copy mode, scan mode, etc.) appear on the [Filter by Job] tab to let you restrict the search to jobs of a selected mode.
- If you touch a file key that has a password, a password entry screen appears. Enter the password (5 to 8 digits) for the file with the numeric keys.
- If the file that you wish to use is not in My Folder, touch the [Folder Select] key. The folder selection screen appears. Select the appropriate folder and touch a file key that you wish to use.



Touch the key of the operation that you wish to perform.

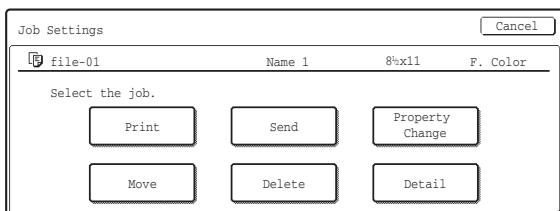

- For detailed information on each key, see "JOB SETTINGS SCREEN" (page 27).

---

---

# FOLDER AND FILE SELECTION SCREENS

To call up and use a stored file, the folder and file must be selected. The folder selection screen and file selection screen are explained below.

## FOLDER SELECTION SCREEN

Two different screens appear depending on whether or not user authentication is enabled on the machine.

### When user authentication is not enabled

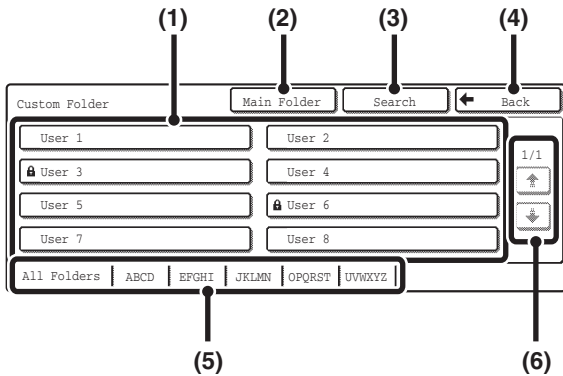

### When user authentication is enabled

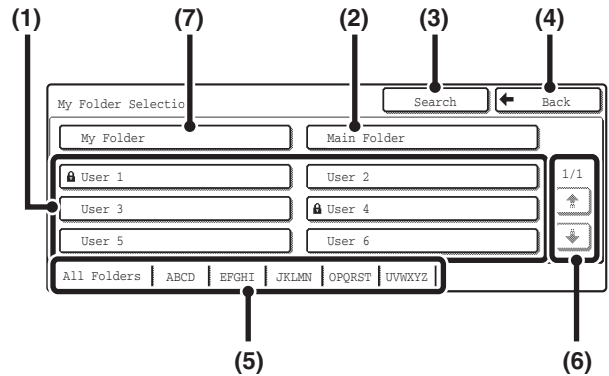

#### (1) Folder keys

The Custom Folders that have been created using "Document Filing Control" in the system settings are displayed. Touch a folder key to display its file selection screen.

If a password has been set for a Custom Folder, a password entry screen will appear when the folder is touched. The password must be entered.

#### (2) [Main Folder] key

Touch this key to switch between the Main Folder display and the Custom Folder display. When the file selection screen of the Main folder appears, this key is the [Custom Folder] key.

#### (3) [Search] key

Touch this key to open the search screen. This lets you search for a file using a user name, file, or folder name.

#### (4) [Back] key

Touch this key to return to the base screen of document filing mode.

#### (5) Index tabs

All folders appear on the [All Folders] tab. Touch a tab to display the Custom Folders whose initials (set in "Document Filing Control" in the system settings) match the letters on the tab.

#### (6) [Up/Down] keys

Use these to change the folder list page that is displayed.

#### (7) [My Folder] key

This key appears when user authentication is enabled. Touch the key to display the file selection screen of My Folder. Even if user authentication was performed, if My Folder was not specified in the user registration settings, this key will be grayed out to prevent selection.

# FILE SELECTION SCREEN

The file selection screen of the Quick File Folder, Main Folder, and Custom Folders is explained below.

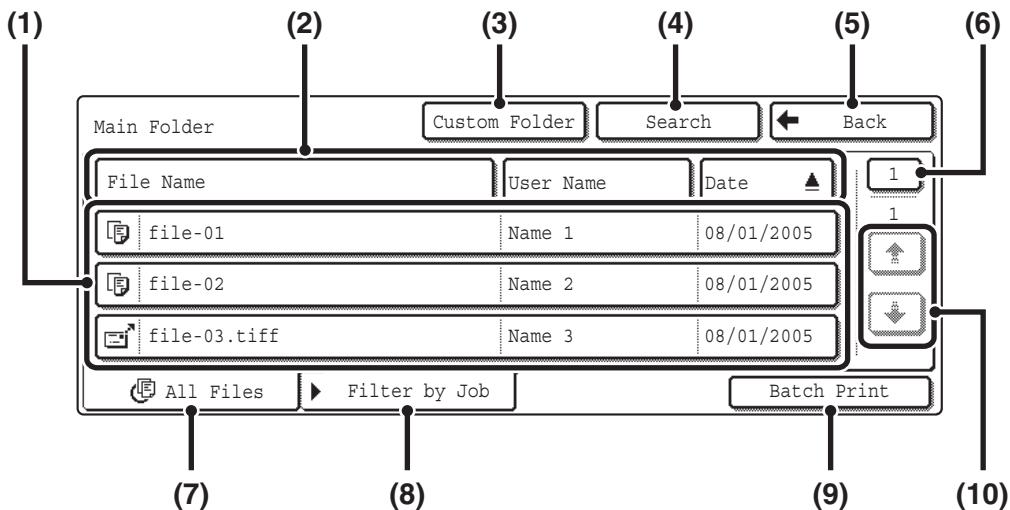

## (1) File keys

The stored files are displayed. An icon showing which mode the file was stored from, the file name, the user name, and the date the file was stored appear in each file key. When a file is touched, the job setting screen appears.

### Job icons

	Copy		Internet fax		Print
	Fax		Scan to E-mail		Scan to HDD
	Scan to FTP		Scan to Desktop		Scan to Network Folder
	PC-Fax		PC-I-Fax		

## (2) [File Name] key, [User Name] key, [Date] key

Use these keys to change the order of display of the file keys. When one of the keys is touched, ▲ or ▼ appears in the key.

- When ▲ appears in the [File Name] key or [User Name] key, the files appear by name or user name in ascending order.
- When ▲ appears in the [Date] key, the files appear in order from the oldest date.
- When ▼ appears in the [File Name] key or [User Name] key, the files appear by name or user name in descending order.
- When ▼ appears in the [Date] key, the files appear in order from the most recent date.

## (3) [Custom Folder] key

Touch this key to switch between the Main Folder display and the Custom Folder display. When the file selection screen of the Main Folder appears, this key is the [Custom Folder] key.

## (4) [Search] key

When this key is touched, the search screen appears. [SEARCHING FOR A STORED FILE](#) (page 42)

## (5) [Back] key / [Folder Select] key

When the [Back] key appears in the file selection screen of the Quick File Folder or the Main Folder, it can be touched to return to the base screen of document filing mode.

When the [Back] key appears in the file selection screen of a Custom Folder, it can be touched to return to the Custom Folder selection screen.

When the [Folder Select] key appears, it can be touched to open the folder selection screen.

[FOLDER SELECTION SCREEN](#) (page 25)

## (6) Page key

When multiple pages exist, use this key to enter the number of a page that you wish to display. When the key is touched, a page number entry screen appears. Enter the desired page number (3 digits) with the numeric keys. For example, to display page 3, enter "003".

## (7) [All Files] tab

Touch this tab to show the keys of all files, regardless of the mode from which they were stored.

## (8) [Filter by Job] tab

Touch this key to display the following screen.

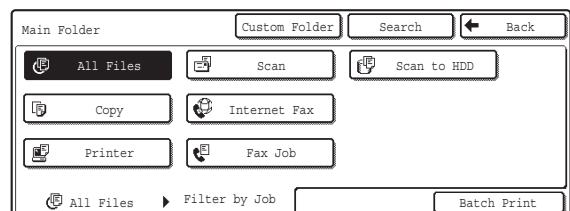

Touch a mode key to show a list of the files that were stored from that mode.

## (9) [Batch Print] key

Touch this key to print all files in a folder. [BATCH PRINTING](#) (page 30)

## (10) ▲ / ▼ keys

Use these keys to switch through the file list pages.

# JOB SETTINGS SCREEN

When a file key is touched, the following screen appears. Touch the key of the operation that you wish to perform and select settings.

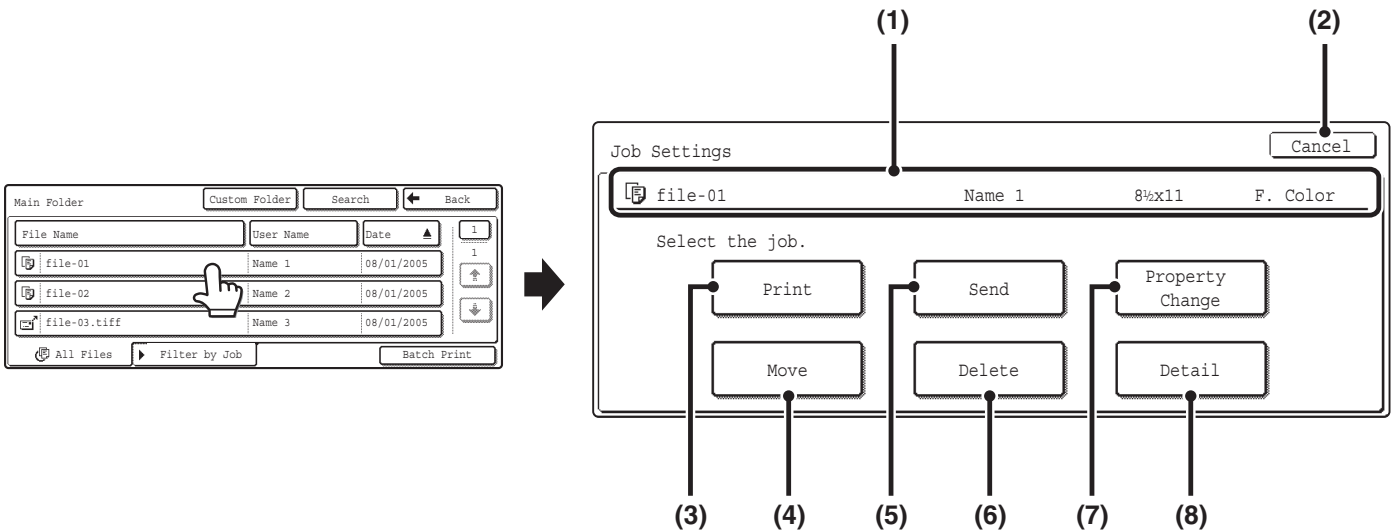

**(1) File display**

This shows information on the currently selected file (job icon, file name, user name, original size, and color mode).

**(2) [Cancel] key**

Touch this key to cancel the operation and return to the file selection screen.

**(3) [Print] key**

Touch this key to print the selected file.  
[PRINTING A STORED FILE](#) (page 28)

**(4) [Move] key**

The folder in which a file is stored can be changed. (The file can be moved to a different folder.)  
[MOVING A STORED FILE](#) (page 37)

**(5) [Send] key**

A stored file can be sent by fax, Internet fax, or scan transmission.  
[SENDING A STORED FILE](#) (page 32)

**(6) [Delete] key**

Touch this key to delete a file that is no longer needed.  
[DELETING A STORED FILE](#) (page 39)

**(7) [Property Change] key**

Use this key to change the property ("Sharing", "Protect", "Confidential") of a stored file.  
[PROPERTIES OF STORED FILES](#) (page 35)

**(8) [Detail] key**

Touch this key to show detailed information on the selected file.  
 When this key is touched, the following screen appears.

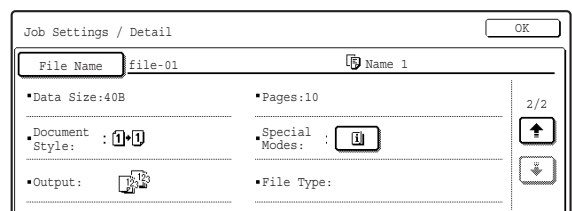
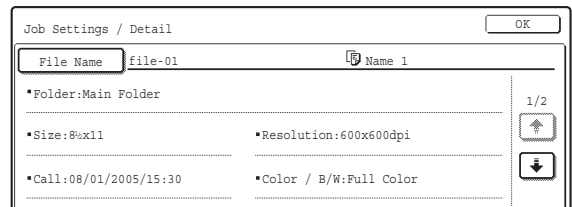

There are two Detail screens. Touch the key or key to switch between the two screens.

If you wish to change the file name, touch the [File Name] key in this screen.

A text entry screen will appear. Enter the desired file name. To enter text, see "6. ENTERING TEXT" in the User's Guide.

An icon appears when a special mode is selected. You can touch the icon to check the special modes that are selected.



# PRINTING A STORED FILE

A file stored using document filing can be called up and printed when needed. The settings used when the file was stored are also stored, and thus the file can be printed again using those settings. The file can also be modified before printing by changing the print settings.

1



Press the [DOCUMENT FILING] key.

2

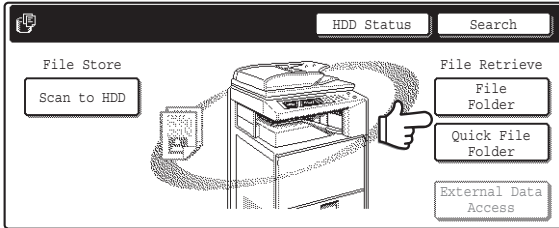

If the file was stored using "File", touch the [File Folder] key. If the file was stored using "Quick File", touch the [Quick File Folder] key.

If you touched the [Quick File Folder] key, go to step 4. The Quick File Folder opens in step 4.



### System Settings (Administrator): User Registration

If user authentication is enabled and "My Folder" is specified in "User Registration" in the system settings, go to step 4. The Custom Folder specified as "My Folder" opens in step 4.

3

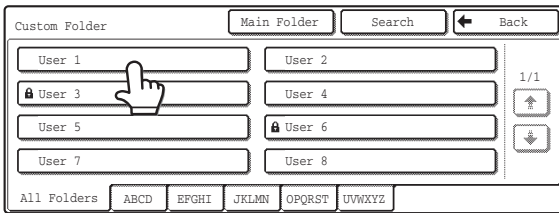

Touch the key of the folder that contains the desired file.

If a password is set for the selected folder, a password entry screen will appear.

Enter the password with the numeric keys (5 to 8 digits) and touch the [OK] key.

The above screen shows the Custom Folders as an example. If you wish to switch to the Main Folder, touch the [Main Folder] key.



4

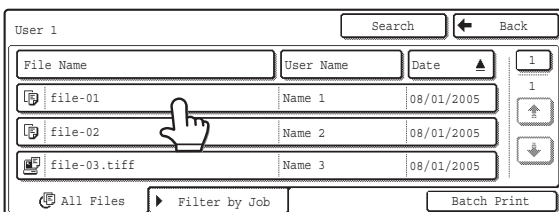

Touch the key of the desired file.

If a password is set for the selected file, a password entry screen will appear.

Enter the password with the numeric keys (5 to 8 digits) and touch the [OK] key.

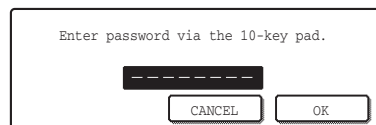

- The [Filter by Job] tab can be touched to show the mode keys (copy mode, scan mode, etc.). Touch a mode key to show a list of the files that were stored from that mode. When you know the mode from which a file was stored, touching the [Filter by Job] tab lets you find the file quickly.
- You can touch the [File Name] key, the [User Name] key, or the [Date] key to change the order of display of the files.
- To print all files in the folder, touch the [Batch Print] key.

[BATCH PRINTING](#) (page 30)

5

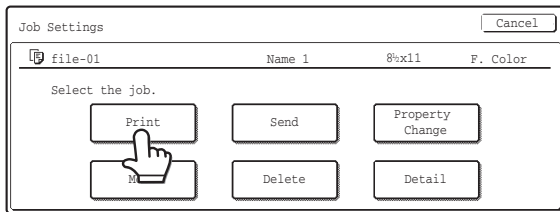

Touch the [Print] key.

6

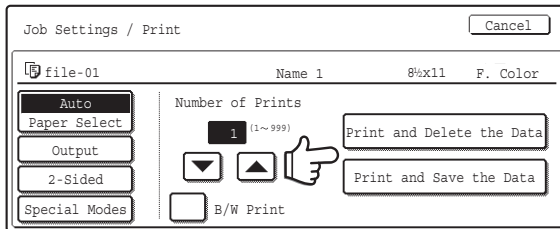

Touch the [Print and Delete the Data] key or the [Print and Save the Data] key.

If the [Print and Delete the Data] key is touched, the file will be deleted after printing.

If the [Print and Save the Data] key is touched, the file will be saved after printing.

Output settings, two-sided printing, special modes, the number of copies, and other settings can be selected. For more information, see "[PRINT SETTINGS SCREEN](#)" (below).



- A file saved in black and white or grayscale cannot be printed in color.
- A long-size scan to HDD or scan send job cannot be printed.  
A long-size fax transmission job or Internet fax transmission job can be printed.
- When print settings are changed as explained above, only the number of copies is changed in the stored settings.
- The printing speed may be somewhat slow depending on the resolution and exposure mode settings of the saved file.

## PRINT SETTINGS SCREEN

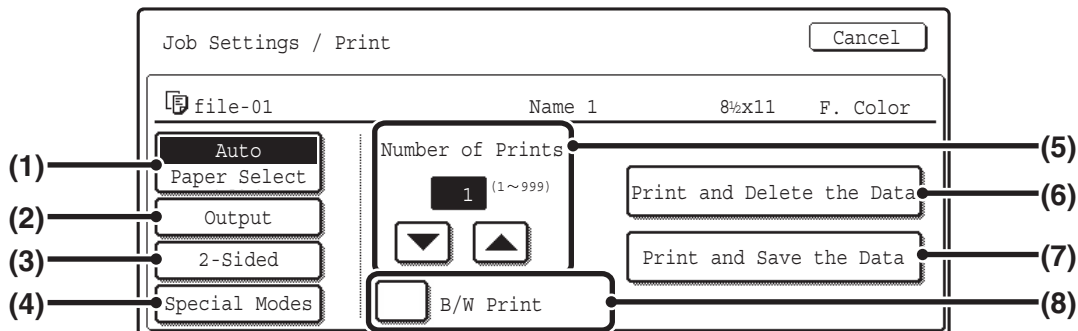

- [Paper Select] key**  
Use this key to set the paper size.
- [Output] key**  
Use this key to select Sort, Group or Staple Sort, and to select the output tray.
- [2-Sided] key**  
Use this key to select the orientation of the image on the reverse side of the paper for 2-sided printing. To have the front and back images oriented in the same direction, touch the [2-Sided Booklet] key. To have the front and back images oriented opposite to each other, touch the [2-Sided Table] key. Note that the size and orientation of the saved image may cause these keys to have the opposite effect. If neither of these keys is selected (neither is highlighted), 1-sided printing will take place.
- [Special Modes] key**  
Touch this key to select "Margin Shift", "Pamphlet style", "2in1 / 4in1", "Tandem Print", or the "Stamp".  
This key does not appear if the file was saved from print mode.
- ▼ ▲ keys**  
Use these keys to set the number of copies. The number of copies can also be set with the numeric keys.
- [Print and Delete the Data] key**  
Printing begins when this key is touched. When printing is finished, the file will be automatically deleted.
- [Print and Save the Data] key**  
Printing begins when this key is touched. The file will not be deleted after printing.
- [B/W Print] checkbox**  
Select this checkbox if the file was saved in color and you wish to print it in black and white.  
When the file is saved in black and white, this checkbox does not appear.

# BATCH PRINTING

All files that have the same user name and password can be printed at once.

1

**Touch the [Batch Print] key.**

2

**Touch the [User Name] key.**

3

**Select the user name.**

There are 4 ways to select the user name:

**(A) Touch the one-touch key of the user name.**  
The touched user name is highlighted.

If you accidentally select the wrong user name, touch the key of the correct name.

**(B) Touch the [Default User] key.**  
The user name can be selected from the default users in the user account settings.

**(C) Touch key.**  
An area [---] for directly entering a registration number will appear at the top of the key. The user name can be selected by entering "Registration No." that was configured when the user was stored.

**(D) Touch the [Direct Entry] key.**  
A text entry screen will appear. Directly enter the user name. To enter text, see "6. ENTERING TEXT" in the User's Guide.

After selecting the user name, touch the [OK] key.



When all users and user unknown batch printing is enabled in the system settings (administrator), the [All Users] key and the [User Unknown] key can be selected.

The [All Users] key can be touched to select all files in the folder (the files of all users).

The [User Unknown] key can be touched to select all files in the folder that do not have a user name.

4

If a password has been established, touch the [Password] key.

Enter the password with the numeric keys (5 to 8 digits) and touch the [OK] key. Only files that have the same password will be selected.

If you do not wish to enter a password, go to the next step.

5

To set the number of copies, touch the [Change PRT.No.] key.

If you wish to use the number of copies stored with each file, go to step 6.

(1) Touch the [Apply the Number from Stored Setting of Each Job] checkbox so that it is not selected () .

(2) Set the number of copies with the   keys.

The number of copies can be also set with the numeric keys.

(3) Touch the [OK] key.

6

Touch the [Print and Delete the Data] key or the [Print and Save the Data] key.

If the [Print and Delete the Data] key is touched, the files will be deleted after printing.

If the [Print and Save the Data] key is touched, the files will be saved after printing.

If there are no files that match the search conditions, you will return to the file list screen.



All files that have the specified user name/password can be deleted by touching the [Delete the Data] key.

# SENDING A STORED FILE

A file stored by document filing can be called up and transmitted. The transmission settings that were stored with the file are also called up, allowing you to resend the file using the same settings. If needed, you can also change the transmission settings.

1



Press the [DOCUMENT FILING] key.

2

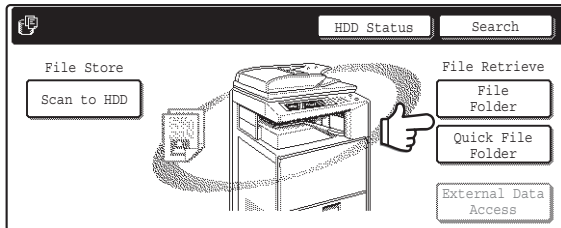

If the file was stored using "File", touch the [File Folder] key. If the file was stored using "Quick File", touch the [Quick File Folder] key.

If you touched the [Quick File Folder] key, go to step 4. The Quick File Folder opens in step 4.



## System Settings (Administrator): User Registration

If user authentication is enabled and "My Folder" is specified in "User Registration" in the system settings, go to step 4. The Custom Folder specified as "My Folder" opens in step 4.

3

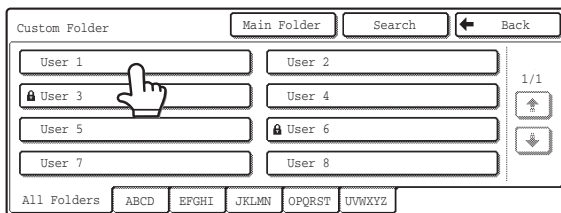

Touch the key of the folder that contains the desired file.

If a password is set for the selected folder, a password entry screen will appear.

Enter the password with the numeric keys (5 to 8 digits) and touch the [OK] key.

The above screen shows the Custom Folders as an example. If you wish to switch to the Main Folder, touch the [Main Folder] key.

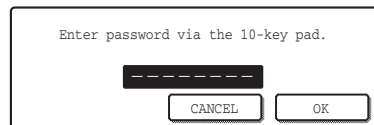

4

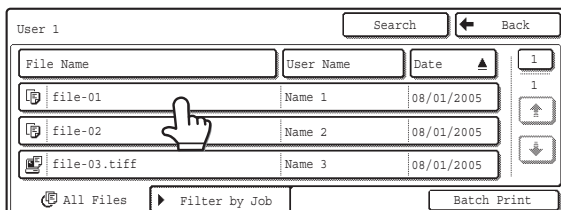

Touch the key of the desired file.

If a password is set for the selected folder, a password entry screen will appear.

Enter the password with the numeric keys (5 to 8 digits) and touch the [OK] key.

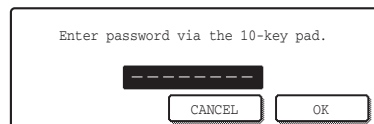

- The [Filter by Job] tab can be touched to show the mode keys (copy mode, scan mode, etc.). Touch a mode key to show a list of the files that were stored from that mode. When you know the mode from which a file was stored, touching the [Filter by Job] tab lets you find the file quickly.
- You can touch the [File Name] key, the [User Name] key, or the [Date] key to change the order of display of the files.

5

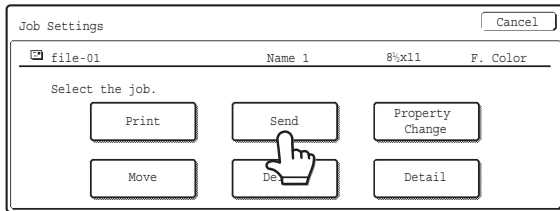

Touch the [Send] key.

6

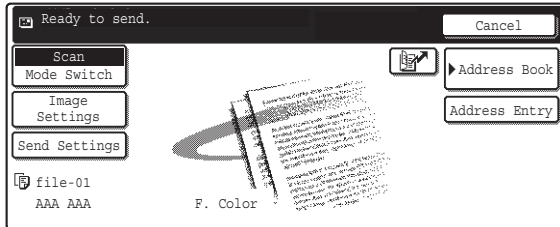

Select transmission settings.

For information on the settings, see "SEND SETTINGS SCREEN" (page 34).

7

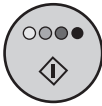

or

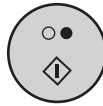

Press the [COLOR START] key (○●●●) or the [BLACK & WHITE START] key (○●).



If you are sending a fax or Internet fax, only the [BLACK & WHITE START] key (○●) can be used.



- A file saved in black and white or grayscale cannot be transmitted in color.
- A stored print job cannot be transmitted.
- These transmission methods require installation of the corresponding options.
- If any of the following special modes were included in the saved file, the file cannot be transmitted.  
"Pamphlet Copy", "Covers/Inserts", "Photo Repeat", "Multi-Page Enlargement", "Multi shot" for Copying
- If any of the following special modes were included in the saved file, the file can be transmitted but the special modes will not be executed.  
"Margin Shift", "Transparency Inserts", "Book Copy", "Tab Copy", "Stamp", all "Color Adjustment" Menu items, "Centering"

# SEND SETTINGS SCREEN

The keys that appear in the send settings are explained below. For more information on each of the settings, see "BASE SCREEN OF FAX MODE" in the Facsimile Guide and "BASE SCREEN" in the Scanner Guide.

## Example of scan mode

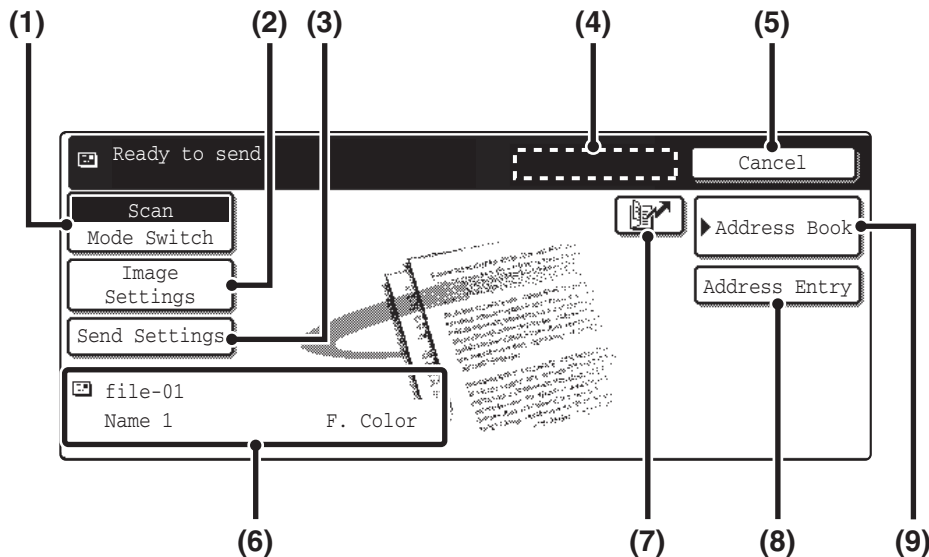

**(1) [Mode Switch] key**

Use this key to select fax mode, scan mode, or Internet fax mode.

**(2) [Image Settings] key**

Touch this key to select send settings. The settings that can be selected vary by mode.

• **Fax mode**

**[Resolution] key**

Use this to select the resolution. A resolution setting higher than the resolution at which the file was stored cannot be selected.

**[Special Modes] key**

This displays the [Timer], [Own Number Select] and [Transaction Report] keys.

• **Scan mode**

**[Resolution] key**

Use this to select the resolution. A resolution setting higher than the resolution at which the file was stored cannot be selected.

**[File Format] key**

This lets you select the file type, compression ratio, and color mode.

**[Special Modes] key**

This displays the [Timer] key.

• **Internet fax mode**

**[Resolution] key**

Use this to select the resolution. A resolution setting higher than the resolution at which the file was stored cannot be selected.

**[File Format] key**

[TIFF-S] or [TIFF-F] can be selected.

**[Special Modes] key**

This displays the [Timer] and [Transaction Report] keys.

**(3) [Send Settings] key**

This key appears in scan mode and Internet fax mode. Touch the key to enter a subject and a file name. In scan mode, a sender can also be specified.

**(4) [Next Address] key**

This key appears when at least one address has been entered. Use this key to send a file to multiple destinations.

**(5) [Cancel] key**

This returns you to the base job settings screen.

**(6) File name / User name display**

This shows the icon of the file to be sent, the file name, the user name, and the color mode (color / black and white).

**(7) [Next Address] key**

A destination can be selected by touching this key and entering the 3-digit number that was assigned to the destination when the e-mail address or fax number of the destination was stored in a one-touch key or group key.

**(8) [Address Entry] key or [Sub Address] key**

Use this key to directly enter an address when sending a file in scan mode or Internet fax mode. In fax mode, use this key to enter a sub-address and password for F-code communication.

**(9) [Address Book] key**

Touch this key to display the destinations stored in the address book.



# PROPERTIES OF STORED FILES

## FILE PROPERTIES

The protect setting can be selected for files saved with the document filing function. This prevents a file from being moved or automatically or manually deleted.

Three attributes are available for saved files: [Sharing], [Protect], and [Confidential]. When saved with the [Sharing] attribute, a file is not protected. When saved with the [Protect] or [Confidential] attribute, a file is protected.

Files saved to the Quick File Folder are all [Sharing]. When saving a file to the Main Folder or a Custom Folder, [Sharing] or [Confidential] can be selected.

<b>Sharing</b>	A [SHARING] file can be changed to a [Protect] or [Confidential] file using [Property change].
<b>Protect</b>	A password cannot be set for a [Protect] file, however, as long as the property of the file is not changed to [Sharing] with [Property Change], the file will be protected and [Delete] and [Move] cannot be used. The  icon appears with the mode icon in the file key of a confidential file.
<b>Confidential</b>	A password is set for a [Confidential] file to protect it. (The password must be entered to call up the file.) The  icon appears with the mode icon in the file key of a protected file.

## CHANGING THE PROPERTY

1



**Press the [DOCUMENT FILING] key.**

2



**If the file was stored using "File", touch the [File Folder] key. If the file was stored using "Quick File", touch the [Quick File Folder] key.**

If you touched the [Quick File Folder] key, go to step 4. The Quick File Folder opens in step 4.

3



**System Settings (Administrator): User Registration**

If user authentication is enabled and "My Folder" is specified in "User Registration" in the system settings, go to step 4. The Custom Folder specified as "My Folder" opens in step 4.

3

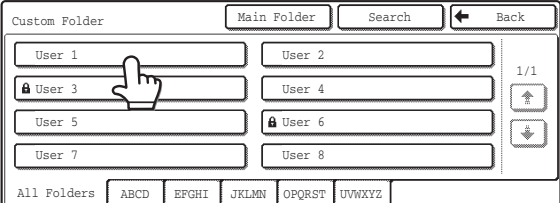

**Touch the key of the folder that contains the desired file.**

If a password is set for the selected folder, a password entry screen will appear.

Enter the password with the numeric keys (5 to 8 digits) and touch the [OK] key.

The above screen shows the Custom Folders as an example. If you wish to switch to the Main Folder, touch the [Main Folder] key.

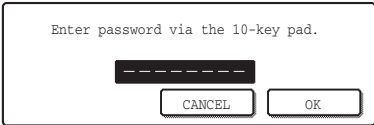



4

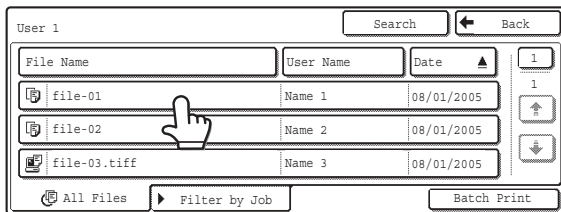

## Touch the key of the desired file.

If a password is set for the selected file, a password entry screen will appear.

Enter the password with the numeric keys (5 to 8 digits) and touch the [OK] key.

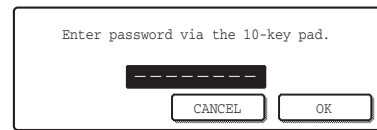

- The [Filter by Job] tab can be touched to show the mode keys (copy mode, scan mode, etc.). Touch a mode key to show a list of the files that were stored from that mode. When you know the mode from which a file was stored, touching the [Filter by Job] tab lets you find the file quickly.
- You can touch the [File Name] key, the [User Name] key, or the [Date] key to change the order of display of the files.

5

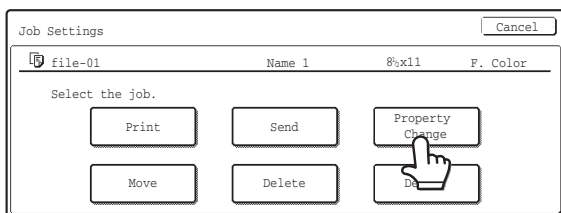

## Touch the [Property Change] key.

6

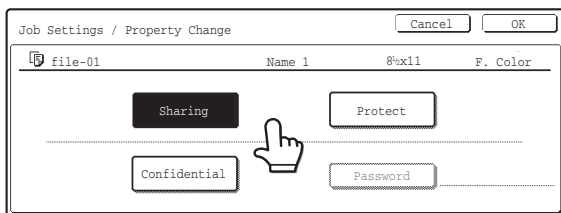

## Touch the key of the desired property and then touch the [OK] key.

If you touch the [Confidential] key, the [Password] key appears. Touch the [Password] key to open the password entry screen. Enter the password with the numeric keys (5 to 8 digits) and touch the [OK] key.



### Restrictions on changing the property

- A file that is set to "Sharing" can be changed to "Protect" or "Confidential". However, a "Sharing" file that is saved in the Quick File Folder can only be changed to "Protect".
- A file that is set to "Protect" can be changed to "Sharing" or "Confidential". However, a "Protect" file that is saved in the Quick File Folder can only be changed to "Sharing".
- A file that is saved in the Quick File Folder cannot be changed to "Confidential". If the file is moved to the Main Folder or a Custom Folder, the property can be changed to "Confidential".
- Two properties cannot be selected for a single file.

# MOVING A STORED FILE

The folder in which a file is stored can be changed. (The file can be moved to a different folder.)

1



Press the [DOCUMENT FILING] key.

2

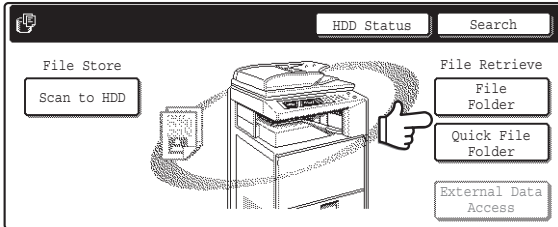

If the file was stored using "File", touch the [File Folder] key. If the file was stored using "Quick File", touch the [Quick File Folder] key.

If you touched the [Quick File Folder] key, go to step 4. The Quick File Folder opens in step 4.



## System Settings (Administrator): User Registration

If user authentication is enabled and "My Folder" is specified in "User Registration" in the system settings, go to step 4. The Custom Folder specified as "My Folder" opens in step 4.

3

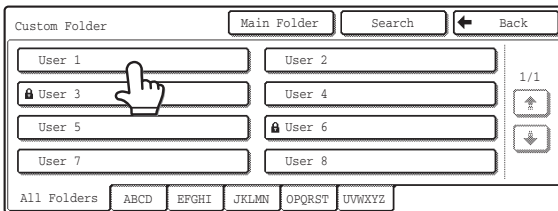

Touch the key of the folder that contains the desired file.

If a password is set for the selected folder, a password entry screen will appear.

Enter the password with the numeric keys (5 to 8 digits) and touch the [OK] key.

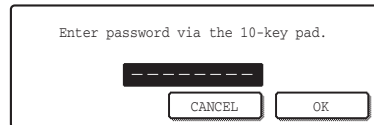

The above screen shows the Custom Folders as an example. If you wish to switch to the Main Folder, touch the [Main Folder] key.

4

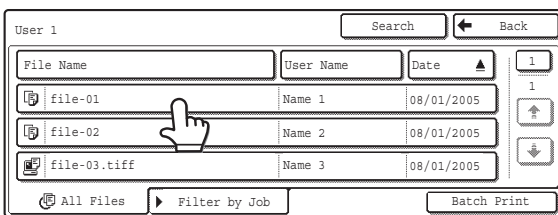

Touch the key of the desired file.

If a password is set for the selected file, a password entry screen will appear.

Enter the password with the numeric keys (5 to 8 digits) and touch the [OK] key.



- The [Filter by Job] tab can be touched to show the mode keys (copy mode, scan mode, etc.). Touch a mode key to show a list of the files that were stored from that mode. When you know the mode from which a file was stored, touching the [Filter by Job] tab lets you find the file quickly.
- You can touch the [File Name] key, the [User Name] key, or the [Date] key to change the order of display of the files.

5

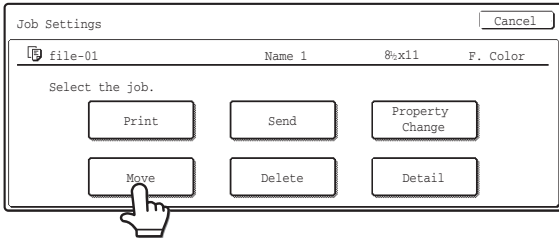

Touch the [Move] key.

6

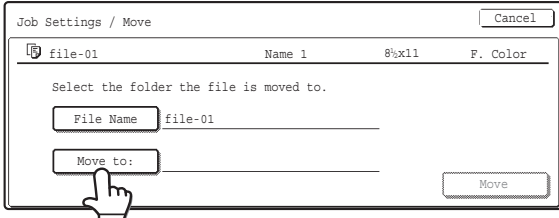

Touch the [Move to:] key.



- A file cannot be moved to the Quick File Folder.
- When the file name is changed, the file is moved to the new folder with the new name. The file is not copied to the new folder.
- To change the file name, touch the [File Name] key.

7

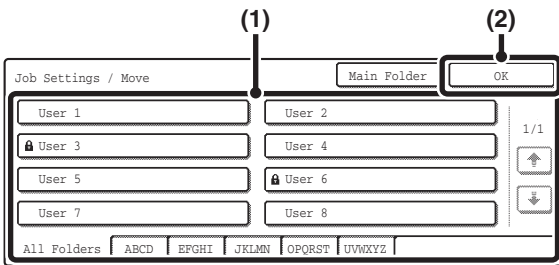

Select the destination folder.

(1) Select the folder to which you want to move the file.

If a password is set for the selected folder, a password entry screen will appear.  
Enter the password with the numeric keys (5 to 8 digits) and touch the [OK] key.



(2) Touch the [OK] key.

The above screen shows the Custom Folders as an example.

8

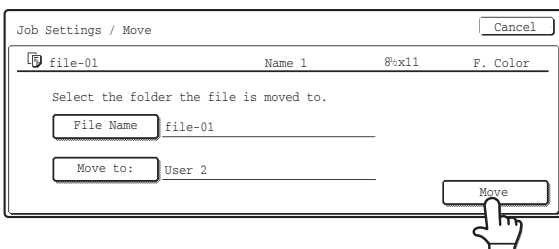

Touch the [Move] key.



A file whose property is "Protect" cannot be moved. To move a protected file, change its property to "Sharing" or "Confidential".

# DELETING A STORED FILE

Stored files that are no longer needed can be deleted.

1



Press the [DOCUMENT FILING] key.

2

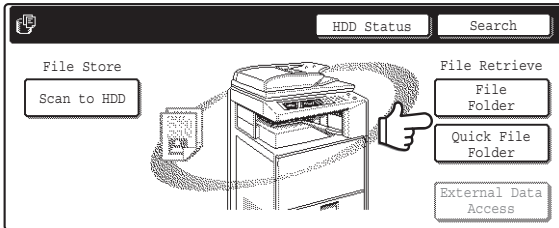

If the file was stored using "File", touch the [File Folder] key. If the file was stored using "Quick File", touch the [Quick File Folder] key.

If you touched the [Quick File Folder] key, go to step 4. The Quick File Folder opens in step 4.



## System Settings (Administrator): User Registration

If user authentication is enabled and "My Folder" is specified in "User Registration" in the system settings, go to step 4. The Custom Folder specified as "My Folder" opens in step 4.

3

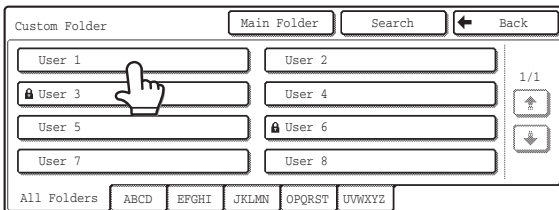

Touch the key of the folder that contains the desired file.

If a password is set for the selected folder, a password entry screen will appear.

Enter the password with the numeric keys (5 to 8 digits) and touch the [OK] key.

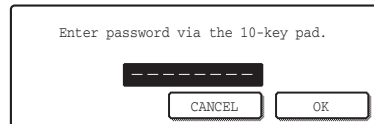

The above screen shows the Custom Folders as an example. If you wish to switch to the Main folder, touch the [Main Folder] key.

4

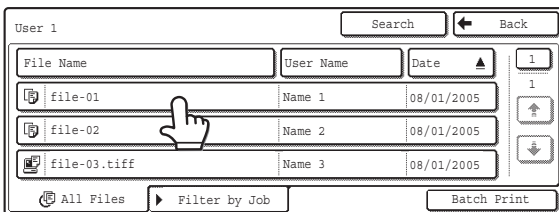

Touch the key of the desired file.

If a password is set for the selected file, a password entry screen will appear.

Enter the password with the numeric keys (5 to 8 digits) and touch the [OK] key.



- The [Filter by Job] tab can be touched to show the mode keys (copy mode, scan mode, etc.). Touch a mode key to show a list of the files that were stored from that mode. When you know the mode from which a file was stored, touching the [Filter by Job] tab lets you find the file quickly.
- You can touch the [File Name] key, the [User Name] key, or the [Date] key to change the order of display of the files.

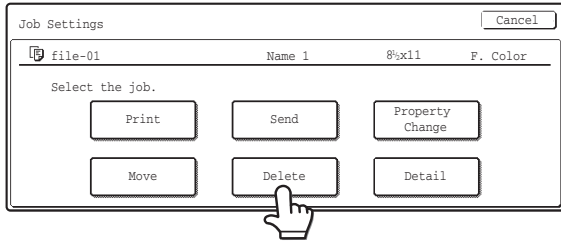

## Touch the [Delete] key.

When the [Delete] key is touched, a confirmation message appears. Touch the [Yes] key.

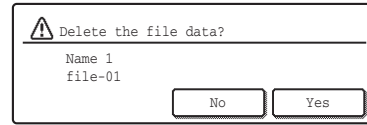

A file whose property is "Protect" cannot be deleted. To delete a protected file, change its property to "Sharing" or "Confidential".

# CALLING UP AND USING A FILE FROM THE JOB STATUS SCREEN

Files stored using File and Quick File appear as keys in the Complete job status screen.

This is convenient when you need to quickly print the saved data of a copy job or quickly send a saved fax to another destination.

1

JOB STATUS



Press the [JOB STATUS] key.

2

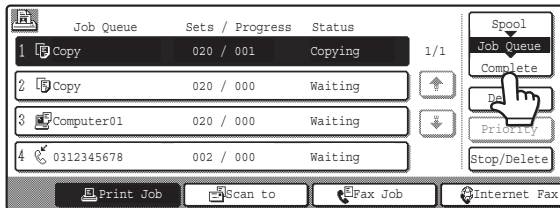

Touch the job status screen selector key to select "Complete".

3

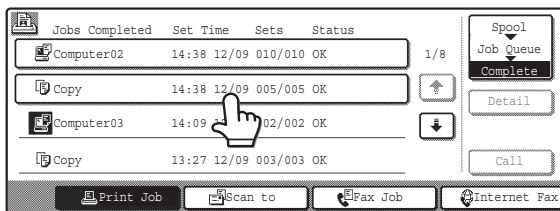

Touch the key of the desired file.

To view information on the selected file, touch the [Detail] key.

4

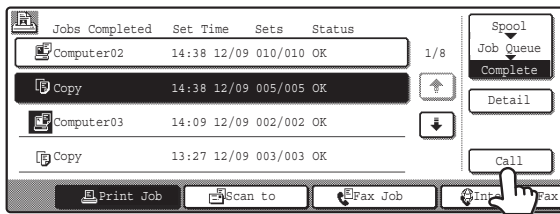

Touch the [Call] key.

5

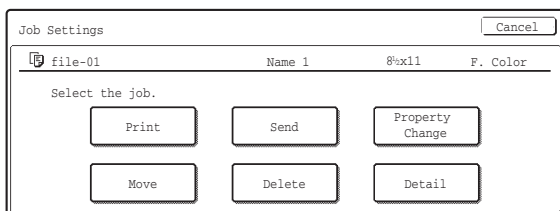

Touch the key of the operation that you wish to perform.

The setting screen of the selected operation will appear.

- PRINTING A STORED FILE (page 28),
- SENDING A STORED FILE (page 32),
- PROPERTIES OF STORED FILES (page 35),
- MOVING A STORED FILE (page 37),
- DELETING A STORED FILE (page 39)

# SEARCHING FOR A STORED FILE

When there are many stored files, it may take time to find a file. The search function of document filing mode can be used to find a file quickly.

## BASIC SEARCH PROCEDURE

The basic procedure for searching all folders on the hard drive is explained here. Searching is possible even when you only know part of the file name or folder name.

**Example: Only part of a file name is known: "Meeting"**

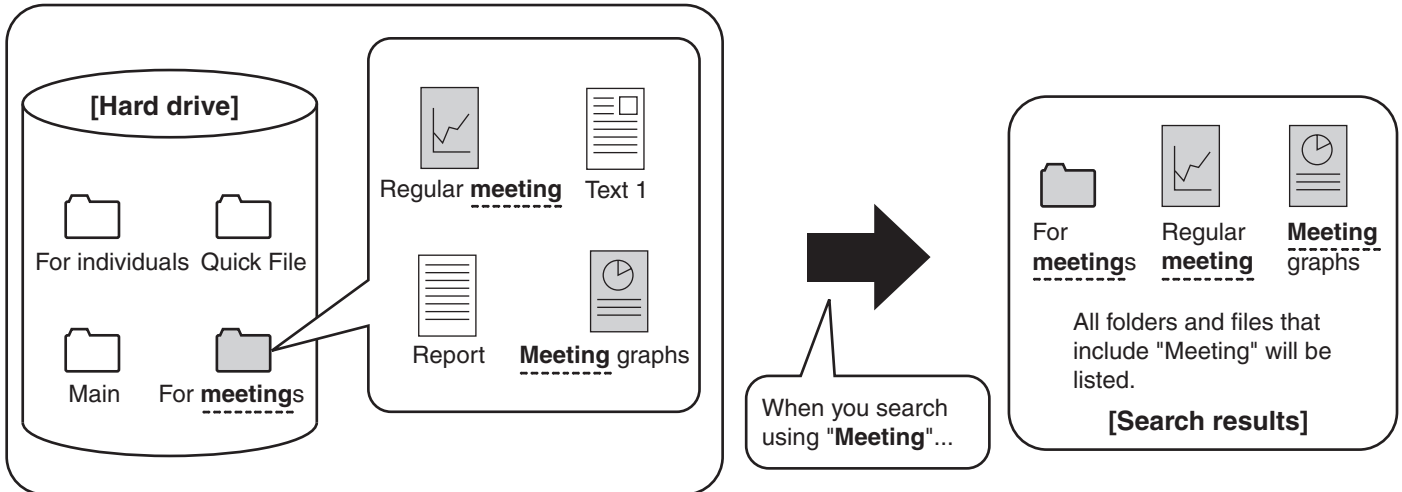

1



Press the [DOCUMENT FILING] key.

2

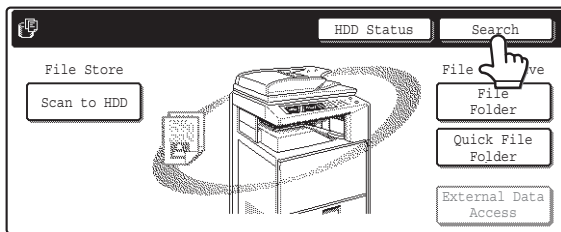

Touch the [Search] key.

3

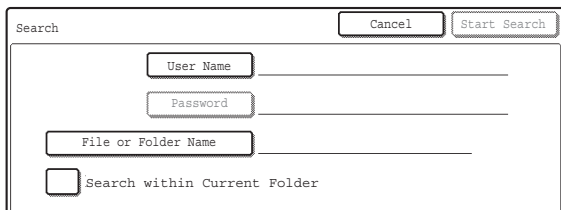

Touch the [User Name] key or the [File or Folder Name] key.

If you know the user name, touch the [User Name] key and go to "Using the user name to search" in step 4.

If you know the file name, touch the [File or Folder Name] key and go to "Using the file name or folder name to search" in step 4.

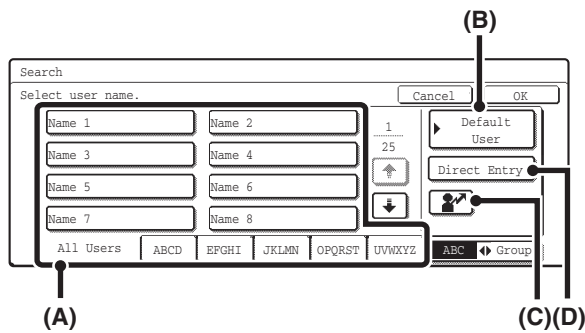

## Using the user name to search

There are four ways to select the user name:

### (A) Touch the one-touch key of the user name.

The touched user name is highlighted.

If you accidentally select the wrong user name, touch the key of the correct name.

### (B) Touch the [Default User] key.

The user name can be selected from the default users in the user account settings.

### (C) Touch the key.

An area [---] for directly entering a registration number will appear at the top of the key. The user name can be selected by entering the 3-digit user number that was configured when the user was stored.

### (D) Touch the [Direct Entry] key.

A text entry screen will appear. Directly enter the user name. To enter text, see "6. ENTERING TEXT" in the User's Guide. Searching is possible even if you only enter the first several letters of the user name.

After selecting the user name, touch the [OK] key. The [Password] key can now be select. Touch the [Password] key and enter the password. This lets you search for all files that have the same user name and password.

## Using the file name or folder name to search

Enter the file name or folder name in the text entry screen that appears and touch the [OK] key.

To enter text, see "6. ENTERING TEXT" in the User's Guide.

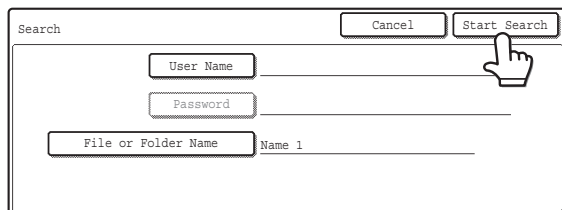

## Touch the [Start Search] key.

The search results will appear in a screen similar to the following screen.

A list of the files that match your search criteria will appear. Touch the desired file name or folder name. The job settings screen will appear.

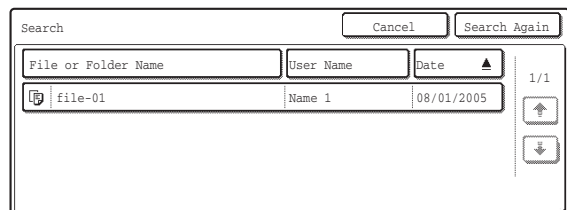

The [Cancel] key can be touched to return to step 2.

The [Search Again] key can be touched to return to step 3.



- When you search using [File or Folder Name], Custom Folders that match the search characters will also appear in the list. When a folder key is touched, a list of the files in the folder appears. If the file you are searching for is in the list, touch it.
- You can also restrict the search to a specified folder. For more information, see "[Searching within a folder](#)" (page 44).
- You can also use the Web pages to search for a file. Click [Document Operations], [Document Filing], and then [Search] in the Web page menu.



# Searching within a folder

You can specify a folder to restrict the search range to that folder. To search within a specified folder, follow the steps below.

1



**Press the [DOCUMENT FILING] key.**

2

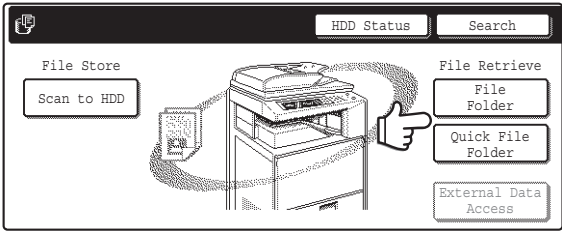

**To search the Main Folder or a custom folder, touch the [File Folder] key. To search the Quick File folder, touch the [Quick File Folder] key.**

If you touched the [Quick File Folder] key, go to step 4. The Quick File Folder opens in step 4.

 **System Settings (Administrator): User Registration**  
 If user authentication is enabled and "My Folder" is specified in "User Registration" in the system settings, go to step 4. The Custom Folder specified as "My Folder" opens in step 4.

3

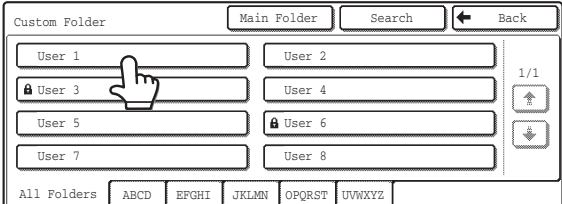

**Touch the key of the folder that you wish to search.**

If a password is set for the selected folder, a password entry screen will appear.

Enter the password with the numeric keys (5 to 8 digits) and touch the [OK] key.

The above screen shows the Custom Folders as an example. If you wish to switch to the Main Folder, touch the [Main Folder] key.

Enter password via the 10-key pad.

CANCEL
OK

4

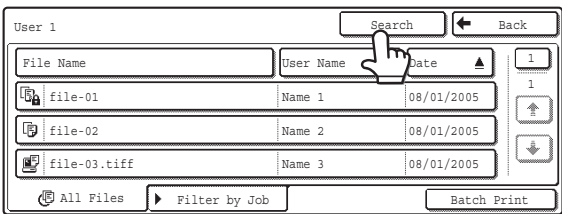

**Touch the [Search] key.**

5

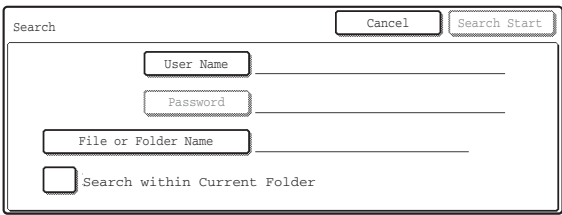

**Touch the [User Name] key or the [File or Folder Name] key.**

If you know the user name, touch the [User Name] key and go to "Using the user name to search" in step 6.

If you know the file name, touch the [File or Folder Name] key and go to "Using the file name or folder name to search" in step 6.

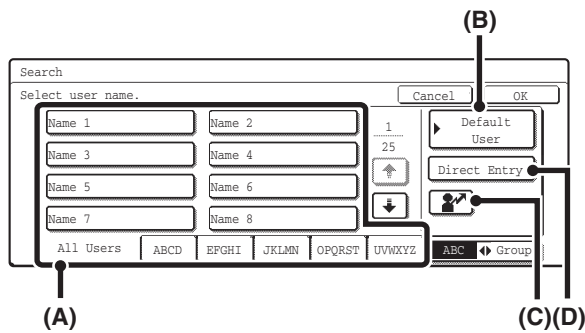

## Using the user name to search

There are four ways to select the user name:

### (A) Touch the one-touch key of the user name.

The touched user name is highlighted.

If you accidentally select the wrong user name, touch the key of the correct name.

### (B) Touch the [Default User] key.

The user name can be selected from the default users in the user account settings.

### (C) Touch the key.

An area [---] for directly entering a registration number will appear at the top of the key. The user name can be selected by entering the 3-digit user number that was configured when the user was stored.

### (D) Touch the [Direct Entry] key.

A text entry screen will appear. Directly enter the user name. To enter text, see "6. ENTERING TEXT" in the User's Guide. Searching is possible even if you only enter the several letters of the user name.

After selecting the user name, touch the [OK] key. When selecting is completed, the [Password] key can be touched. To search only for files that have the same user name and password, touch the [Password] key and enter the password. (It is not possible to search using a password only.)

## Using the file name or folder name to search

Enter the file name or folder name in the text entry screen that appears and touch the [OK] key.

To enter text, see "6. ENTERING TEXT" in the User's Guide.

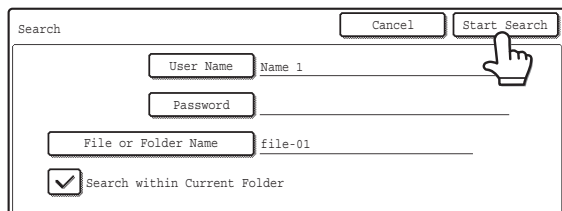

## Touch the [Start Search] key.

To search only files that are in the current folder, select the [Search Within Current Folder] checkbox .

Files in a confidential folder with a password will only appear in the search results when this checkbox is selected in the confidential folder.

The search results will appear in a screen similar to the following screen.

A list of the files that match your search criteria will appear. Touch the key of the desired file. The job settings screen appears.

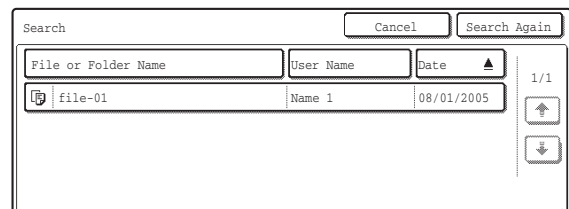

The [Cancel] key can be touched to return to step 2.

The [Search Again] key can be touched to return to step 5.