

SANYO

VIZON®

Model Nos.: DP26746
Nos. de Modelo: DP32746

INTEGRATED HDTV
HIGH-DEFINITION TELEVISION

Wide Screen LCD HDTV

See What You've Been Missing!

Owner's Manual
Manual Del Propietario

ENGLISH

Table of Contents 3

ESPAÑOL

Contenido 33



“Read this manual before assembling
(or using) this product.”

Need assistance?

Visit our Web site at

www.sanyoctv.com

or call toll free 1-800-877-5032

We can Help!

HDMI™
HIGH DEFINITION MULTIMEDIA INTERFACE

DOLBY®
DIGITAL



“As an ENERGY STAR® Partner,
Sanyo Manufacturing Corporation
has determined that this product
meets the ENERGY STAR® guide-
lines for energy efficiency.”

Importado Por :
Comercializadora México
Americana, S. DE R.L. DE C.V.
Nextengo N° 78
Col. Santa Cruz Acayucan
Del. Azcapotzalco, México D.F. C.P.
02770, RFC CMA 9109119L0
Telefono: 55-5328-3500

Printed in U.S.A. SMC, March 2006
Impreso en U.S.A. SMC, Marzo 2006
Part No. / No. de Parte :
1AA6P1P5066--

CAUTION

RISK OF ELECTRIC SHOCK DO NOT OPEN

CAUTION: TO REDUCE THE RISK OF ELECTRIC SHOCK, DO NOT REMOVE COVER (OR BACK). NO USER-SERVICEABLE PARTS INSIDE. REFER SERVICING TO QUALIFIED SERVICE PERSONNEL.

THIS SYMBOL INDICATES THAT DANGEROUS VOLTAGE CONSTITUTING A RISK OF ELECTRIC SHOCK IS PRESENT WITHIN THIS UNIT.



THIS SYMBOL INDICATES THAT THERE ARE IMPORTANT OPERATING AND MAINTENANCE INSTRUCTIONS IN THE LITERATURE ACCOMPANYING THIS UNIT.



WARNING: TO REDUCE THE RISK OF FIRE OR ELECTRIC SHOCK, DO NOT EXPOSE THIS APPLIANCE TO RAIN OR MOISTURE.

IMPORTANT SAFETY INSTRUCTIONS

Important Safety Instructions for LCD DTV

1. Read these instructions.
2. Keep these instructions.
3. Heed all warnings.
4. Follow all instructions.
5. Do not use this apparatus near water.
6. Clean only with dry cloth.
7. Do not block any ventilation openings. Install in accordance with the manufacturer's instructions.
8. Do not install near any heat sources such as radiators, heat registers, stoves, or other apparatus (including amplifiers) that produce heat.
9. Do not defeat the safety purpose of the polarized or grounding-type plug. A polarized plug has two blades with one wider than the other. A grounding-type plug has two blades and a third grounding prong. The wide blade or the third prong are provided for your safety. If the provided plug does not fit fully into your outlet, consult an electrician for replacement of the obsolete outlet.
10. Protect the power cord from being walked on or pinched particularly at plugs, convenience receptacles, and the point where they exit from the apparatus.
11. Only use attachments/accessories specified by the manufacturer.
12. Use only with the cart, stand, tripod, bracket, or table specified by the manufacturer, or sold with the apparatus. When a cart is used, use caution when moving the cart/apparatus combination to avoid injury from tip-over.
13. Unplug this apparatus during lightning storms or when unused for long periods of time.
14. Refer all servicing to qualified service personnel. Servicing is required when the apparatus has been damaged in any way, such as power-supply cord or plug is damaged, liquid has been spilled or objects have fallen into the apparatus, the apparatus has been exposed to rain or moisture, does not operate normally, or has been dropped.
15. If an outside antenna is connected to the television equipment, be sure the antenna system is grounded so as to provide some protection against voltage surges and built up static charges. In the U.S. Selection 810-21 of the National Electrical Code provides information with respect to proper grounding of the mast and supporting structure, grounding of the lead-in wire to an antenna discharge unit, size of grounding conductors, location of antenna discharge unit, connection to grounding electrodes, and requirements for the grounding electrodes.
16. An outside antenna system should not be located in the vicinity of overhead power lines or other electrical light or power circuits, or where it can fall into such power lines or circuits. When installing an outside antenna system, extreme care should be taken to keep from touching such power lines or circuits as contact with them might be fatal.
17. "Apparatus shall not be exposed to dripping or splashing and no objects filled with liquids, such as vases, shall be placed on the apparatus."



EXAMPLE OF ANTENNA
GROUNDING ACCORDING
TO NATIONAL
ELECTRICAL CODE,
ANSI/NFPA 70

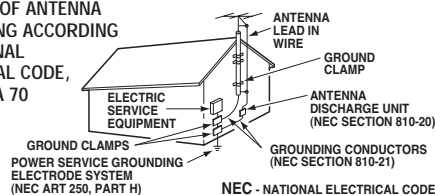

"Note to CATV system installer:

This reminder is provided to call the CATV system installer's attention to Article 820-40 of the NEC that provides guidelines for proper grounding and, in particular, specifies that the cable ground shall be connected to the grounding system of the building, as close to the point of cable entry as practical."

Welcome to the World of Sanyo

Thank you for purchasing this Sanyo LCD High-Definition Digital Television. You made an excellent choice for Performance, Reliability, Features, Value, and Styling.

Important Information

Before installing and operating this DTV, read this manual thoroughly. This DTV provides many convenient features and functions. Operating the DTV

properly enables you to manage those features and maintain it in good condition for many years to come.

If your DTV seems to operate improperly, read this manual again, check operations and cable connections and try the solutions in the "Helpful Hints" section, pages 28 ~ 29 of this manual. If the problem still persists, visit our **website at www.sanyoctv.com** or call 1.800.877.5032. **We can help!**

CONTENTS

Important Safety Instructions	2	DTV Adjustment and Setup	20 ~ 27
Content	3	How to Operate the On-Screen Menu	20
Features	4	Menu Navigation Map	20
Specifications	4	Menu Options:	
Getting Started (Required Initial Setup)	5 ~ 8	All Channel Search	20
Positioning the LCD DTV	5	Digital Cable Search (Optional)	21
Wall Mounting (Optional)	5	Digital Add-On Search	22
Detaching the DTV Stand (Optional)	5	Analog Antenna Signal (Optional)	22
Installing Batteries in the Remote Control	6	Channel Scan Memory	23
Initial Signal Connections	6	Digital Caption	24
Digital (DTV) RF Antenna Connection	6	Changing the Look of Digital Captions	24
Analog RF Antenna Connection	7	To View Captions	24
All Channel Search	8	V-Guide (Parental Control)	25 ~ 26
Analog Antenna signal (optional)	8	To Block MPAA Movie or TV Programs	25
Side and Back Panels	9	To Setup V-Guide Ratings	25
Choose Your Connection	10	To Temporarily Unblock MPAA Movie	
Digital AV Connections	11 ~ 16	or TV Program	26
Connecting External Equipment to HDMI	11	To Unblock All MPAA Movie or All TV Ratings	26
Connecting STB with DVI Output to HDMI	12	MPAA Movie Ratings (Age-Based) Symbol	
Using the Component Jacks to connect		Explanation	26
a DVD Player or other digital equipment	13	DTV Ratings (Age and Content-Based)	
Connecting Digital Audio Out jack to a		Symbol Explanation	26
Multi-Channel Receiver	14	Picture/Sound Adjustment	27
Analog AV Connections	15 ~ 16	Menu Language	27
Using the Analog Video jacks to connect		Helpful Hints (Problems / Solutions)	28 ~ 29
a VCR (or other analog device)	15	Care and Cleaning	29
Connecting Analog Audio Out jacks to		Mexico Guarantee	30
a Stereo Amplifier	16	Warranty (U.S.A. and Canada)	31
Using the Remote Control	17 ~ 19	Child Safety Matters	Inside Back cover

FEATURES

- ◆ DP26746: 26" / DP32746: 32" Wide Screen LCD HDTV
- ◆ Detachable DTV Stand
- ◆ Side bar Controls
- ◆ 3-Line Digital Comb Filter
- ◆ Built-in Digital and Analog Tuners
- ◆ Trilingual Menu options (English, Spanish, or French)
- ◆ V-Chip for Movies and TV guidelines rating limits
- ◆ Closed-Captioning: Analog EIA 608B / Digital EIA-708B
- ◆ Audio Modes: Digital—Main and Sub
Analog—Stereo, Mono, and SAP
- ◆ Tone
- ◆ Front speakers (two): 6 x 12 cm
- ◆ Factory preset adjustments for picture/sound
- ◆ Picture Shape: PIX1, PIX2, PIX3, and PIX4
- ◆ Automatic Channel Search
- ◆ Audio Format: Dolby® digital 5.1 for DTV / Analog for NTSC
- ◆ Receivable Formats: Digital Tuner for ATSC terrestrial broadcasts and nonscrambled (ClearQAM) cable channels. NTSC analog tuner for VHF/UHF or CATV
- ◆ Channel Scan Memory
- ◆ Receives 181 Analog Channels (VHF 2-13 and UHF 14-69; Cable 14-125); and 99 Digital Channels
- ◆ HDMI (High-Definition Multimedia Interface) Input with HDCP (High-bandwidth Digital Content Protection)
- ◆ RF Antenna Input Jacks: Digital and Analog
- ◆ Component Video Input (Two Sets)
- ◆ Rear Composite AV Input
- ◆ S-Video Input
- ◆ Optical Digital Audio Out
- ◆ Fixed Analog Audio Out
- ◆ XDS (Extended Data Services) displays station call letters, title of show, and ratings when broadcast
- ◆ Sleep Timer (3 hours)
- ◆ 32-Key Remote Control

CAUTION: FCC Regulations state that improper modifications or unauthorized changes to this unit may void the user's authority to operate the unit.

SPECIFICATIONS

LCD Panel Size (Measured Diagonally):

DP26746: 26-inches / DP32746: 32-inches

Picture Resolution: 1366 x 768 (WXGA)

Scanning Format: 720p (RF Signals are Converted to 720p)

Jacks and Connectors:

Video 1 Input: Video and Audio L/R Composite S-Video

Video 2 Input: Component (Y/Pb/Pr) with Audio L/R Input

Video 3 Input: Component (Y/Pb/Pr) with Audio L/R Input

Digital Audio Output: Dolby® Digital (Optical)

Analog Audio Output: Audio L/R (Fixed)

HDMI Input: 19-pin connector (Picture/Sound with HDCP)

Sound: Two Speakers, size: 6 x 12 cm

Amplifier: Built-in with 3.0W/ch

Power Requirement: Source: AC 120V, 60Hz

AC Power Consumption (average): DP26746: 135 watts
DP32746: 155 watts

Size and Weight (approximately):

DP26746

Horizontal Dim. (Width)	26.7 in. (678mm)
Vertical Dim. (Height)	21.1 in. (537mm)
Depth Dim. (Thickness)	7.9 in. (201mm)
Weight	26.4 (lbs) 12.0 (Kg)

DP32746

Horizontal Dim. (Width)	32.0 in. (812mm)
Vertical Dim. (Height)	24.2 in. (614mm)
Depth Dim. (Thickness)	7.9 in. (201mm)
Weight	33.0 (lbs) 15.0 (Kg)

Specifications are subject to change without notice.

Trademarks Information:

Manufactured under license from Dolby Laboratories "Dolby" and the double-D symbol are trademarks of Dolby Laboratories.

VIZON® with a double "Z" is a registered trademark of Sanyo Manufacturing Corporation.

GETTING STARTED

POSITIONING THE LCD DTV

Always use an appropriate table or stand when positioning your DTV. For best viewing, avoid locating the DTV where direct sunlight or indoor lighting will fall on the screen. **Do not position the DTV in a confined area. Allow adequate space for proper ventilation.**

Model DP26746

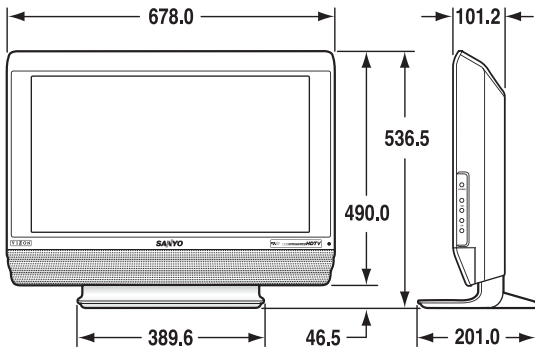

NOTE: All dimensions are in millimeters (mm).

Model DP32746

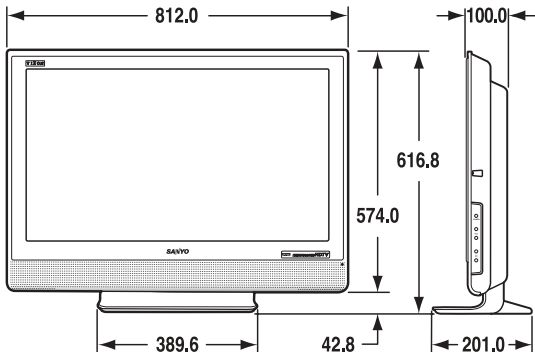

WALL MOUNTING (OPTIONAL)

This LCD DTV is designed so that it may be mounted on a wall, if desired. Use the threaded inserts on the back of your DTV to secure it using a wall mounting kit.

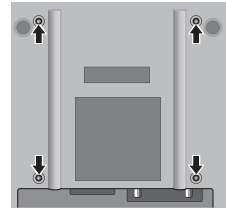

DTV Back View

NOTE: Wall Mounting kit is not supplied, check with your local electronics store.

LCD Mounting screws measurements:

DP26746—M4 Diameter, Length—10mm (minimum) to 20mm (maximum).

DP32746—M6 Diameter, Length—10mm (minimum) to 20mm (maximum).

DETACHING THE DTV STAND (OPTIONAL)

Tools Needed: Phillips screwdriver

Important Note: Place DTV face down on a padded or cushioned surface to protect the screen and finish.

1 Remove four (4) screws from the metal bracket.

CAUTION: Hold the stand firmly as you remove the last screw.

2 Carefully remove the DTV stand.

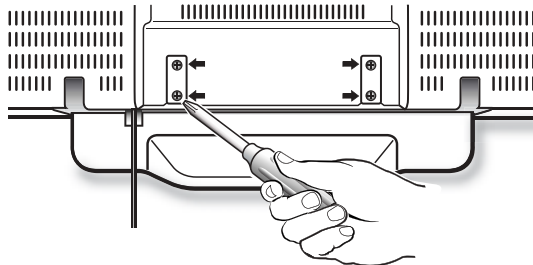

GETTING STARTED (REQUIRED INITIAL SETUP)

INSTALLING BATTERIES IN THE REMOTE CONTROL

Use 2 "AAA" batteries (Not supplied).

Be sure batteries are installed correctly. Match the "+" and "-" signs on the batteries with marks inside the remote control.

NOTES:

- Do not mix old batteries with new ones or mix different types of batteries together.
- Remove the batteries if the remote control will not be used for a month or more. Weak batteries may leak and cause damage. (Normal battery life is roughly six months.)
- Use two "AAA" Alkaline batteries.



IMPORTANT NOTE: Spent or discharged batteries must be recycled or disposed properly in compliance with all applicable laws. For detailed information, contact your local County Solid Waste Authority.

This LCD HDTV is capable of reproducing a crystal clear digital picture and exceptional sound. ***The signal makes the difference!***

INITIAL SIGNAL CONNECTIONS

1 DIGITAL (DTV) RF ANTENNA CONNECTION

- Connect an RF antenna to the Digital Antenna In terminal.

The digital tuner in this DTV receives HD signals from an antenna. Digital signals from a Set-top Box (STB) are received through the Component In jacks.

This DTV can receive ANY resolution being broadcast (HDTV, EDTV, or SDTV).

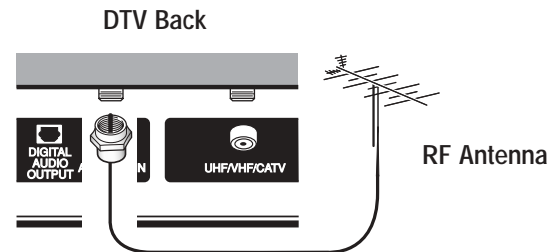

Operational Tip for Monitor Use:

If the DTV is used as a monitor only, with a DVD player or some other type of external equipment, and no cable or antenna signal is available, the following setup is necessary:

Your DTV is designed to automatically search for available channels. Therefore, the initial start up requires that you press the **Channel (CH) ▲** key, enabling the DTV to automatically go through the channel search process before you can operate the DTV.

After the initial channel search is completed, you must press the **Channel (CH) ▲** key again to complete the channel search process. This may take several minutes.

After the channel search process is complete (2 searches), you can press the **INPUT** key on the remote control to use the DTV as a monitor.

2 ANALOG RF ANTENNA CONNECTION

- Connect a Cable signal (with or without a cable box) or RF antenna to the Analog RF input.

The analog tuner in this DTV receives Analog Antenna signals, Analog Cable signals, or the RF output from a VCR or cable box.

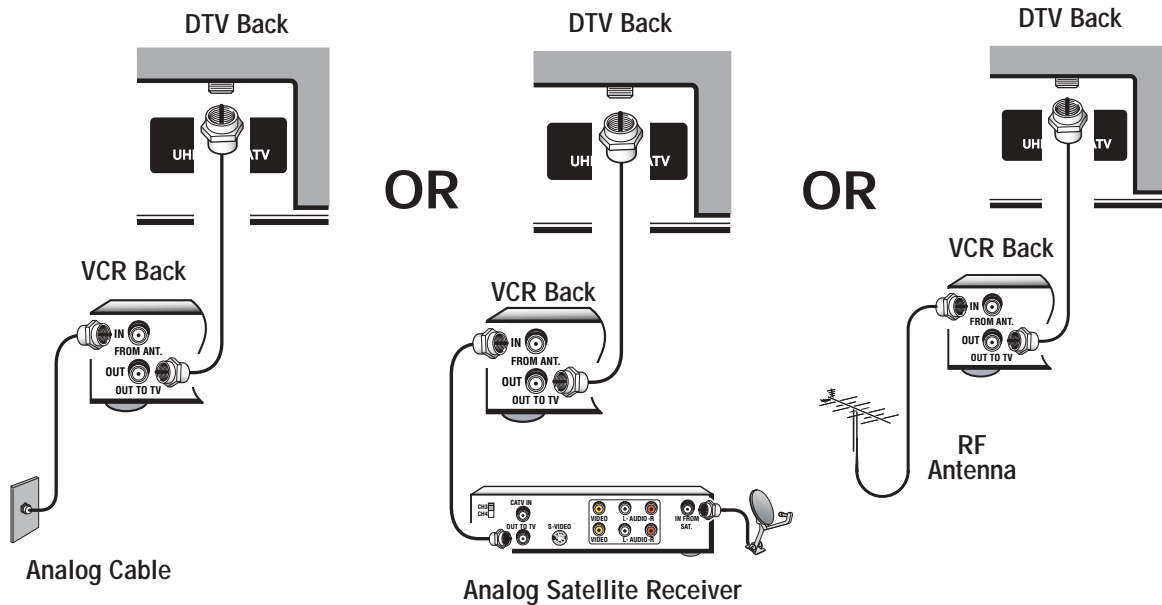

CATV FRANCHISE NOTE: Cable companies, like public utilities, are franchised by local government authorities. To receive cable programs, even with equipment which is capable of receiving cable channels, the consumer must subscribe to the cable company's service.

NOTES: If you do not have a VCR, connect signal directly to the 75 ohm terminal (UHF/VHF/CATV).

Don't be fooled by the phrase "Available in High-Definition." The only resolution available with any of these connections, regardless of the original content, is standard analog (SDTV).

Quick Tips

- DTV will select the correct Antenna mode for the type of Analog RF signal connected automatically.
- Use "Analog Antenna Signal" in the Setup menu to change the Antenna Mode.
- If you move the DTV to a new location, press the **RESET** key twice after connecting the signal and turning on the DTV.

(Continued on page 8.)

3 ALL CHANNEL SEARCH

When the television is powered on for the first time, it automatically checks for the presence of an RF signal.

- Press the **Power** key to turn on the DTV.
- Then press the **Channel Up (CH ▲)** key to automatically search for available channels: Digital (ATSC) and Analog (NTSC).

The All Channel Search contains two processes that are executed simultaneously for digital and analog channels.

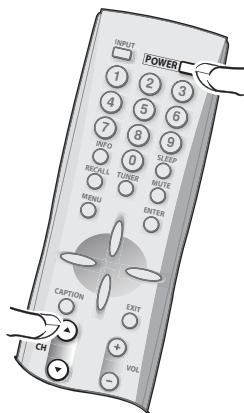

First

Please connect all signals and antennas to jacks and terminals on the back of the TV.

Then press the CHannel UP key.



NOTES:

The on-screen message for digital search will appear with a progress bar and percentile number displayed across the bottom of the screen (to indicate activity) as the search process continues.

Channel information found during the All Channel Search is stored in Analog and Digital Channel Scan Memory databases. After the All Channel Search is completed, the DTV will tune to the lowest Digital channel or lowest Analog channel if no digital channels are found.

If the DTV does not detect any digital or analog channels, a message advising the viewer to check the cables and antenna connections will appear. In this case, you must press the **CHANNEL UP (CH ▲)** key again to repeat the channel search process. If after two searches the DTV still fails to detect any channels, the DTV will tune to analog channel 3. **These two channel searches are necessary even if you plan to use the DTV only as a monitor.**

No input signal sources could be located.
Please check cable or antenna connections.
Then press the CHannel UP key.

If no analog or digital channels are found after the second search, All Channel Search will default to off-air analog channels 2 through 69 and digital channel D3-1. Select analog channels using the remote control keypad. See page 17, item number 2.

4 ANALOG ANTENNA SIGNAL (OPTIONAL)

To change the initial analog tuning system setup (from antenna to cable or cable to antenna), use the on-screen menu, see "Analog Antenna Signal" on page 22.

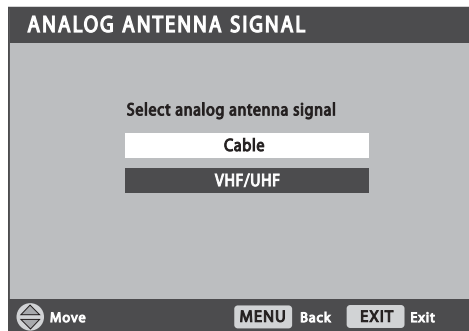

SIDE AND BACK PANELS

Right Side Panel
(see items 8, 11, & 17
on pages 18 & 19)

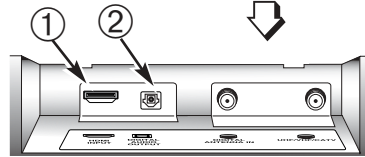
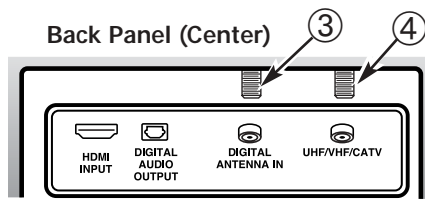
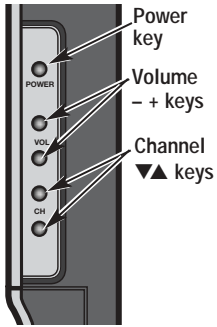

Back Panel—Bottom View (Center)

Back Panel (Right)

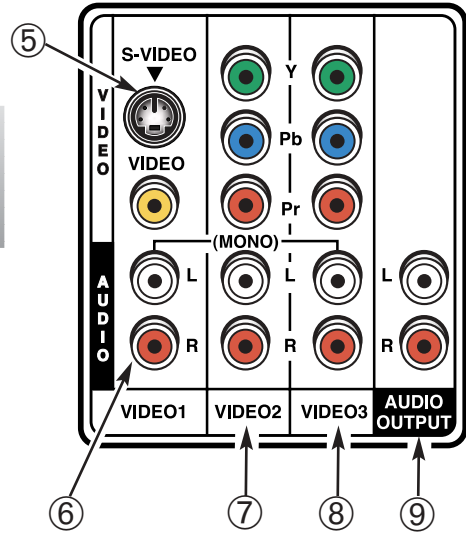











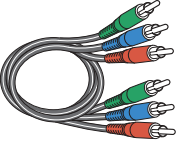
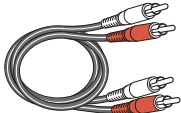

- ① **HDMI (High Definition Multimedia Interface) Input, PAGES 11 and 12**—Connect digital video equipment to this jack. It takes only one high bandwidth cable (not supplied) to communicate between audio/video equipment and this DTV. This connection is compatible with DVI equipped AV devices. (Separate audio connection and an adapter are required for DVI device.)
- ② **Digital Audio Output, PAGE 14**—Use an Optical Audio cable to connect Digital Audio Output to an advanced stereo home theater system equipped with Dolby® Digital 5.1.
- ③ **Digital Antenna Input, PAGE 5**—Connect an RF antenna to this jack.
- ④ **Analog Antenna Input (UHF/VHF/CATV), PAGE 5**—Connect an RF antenna or Analog cable system to this jack.
- ⑤ **S-Video Input (VIDEO1), PAGE 15**—To enhance video detail use the S-Video jacks instead of the Video jacks, if available on your external equipment. (S-Video connection will override connection to the Video input jack [VIDEO1]).

- ⑥ **Audio/Video Input (VIDEO1), PAGE 15**—Connect analog video equipment here.
NOTE: S-Video connection overrides the (VIDEO1) composite video connection.
- ⑦ **Component Video Input (VIDEO2), PAGE 13**—Connect digital video equipment to the Y, Pb, Pr and Audio L/R jacks. These jacks will automatically detect the type of signal being received.
- ⑧ **Component Video Input (VIDEO3), PAGE 13**—Connect digital video equipment to the Y, Pb, Pr and Audio L/R jacks. These jacks will automatically detect the type of signal being received.
- ⑨ **Analog Audio Out (L/R) Jacks, PAGE 16**—Connect external audio equipment here.

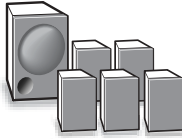
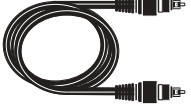
CHOOSE YOUR CONNECTION

This DTV is designed to handle several different connections making it compatible with Digital and Analog devices.

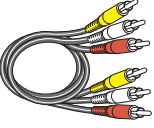
In order to receive the best performance from your DTV, choose your connection using this chart; then go to the specified page for detailed instructions.

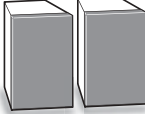
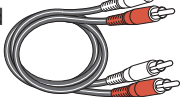
Digital Signal Connections	Compatible External Equipment	Cables Needed (Not Supplied)	Go to Page
HDMI <i>Will accept HDTV (High Bandwidth Video component and Audio 5.1)</i>	Digital Set-Top Box or DVD Player  Video Game 	19 Pin HDMI 	11 OR 12
COMPONENT (Y, Pb, Pr) IN <i>Will accept HDTV, EDTV, or SDTV Video content. (Requires separate audio connections.)</i>	Video Game  Digital Set-Top Box or DVD Player 	Component Video Cable [Green, Blue, and Red connectors]  Audio Cable [White and Red connectors] 	13
DIGITAL AUDIO OUT <i>(Only available when received as part of a Digital RF signal or HDMI signal.)</i>	Multi-Channel Receiver  	Optical Digital Cable 	14
Analog Signal Connections	Compatible External Equipment	Cables Needed (Not Supplied)	Go to Page
COMPOSITE VIDEO OR S-VIDEO IN LEFT / RIGHT ANALOG AUDIO IN	Video Game  DVD Player  VCR 	Composite Video Cable [Yellow, White, and Red connectors]  S-Video Cable 	15
ANALOG AUDIO OUT JACKS	Stereo Amplifier System  	Audio Cable [White and Red connectors] 	16

DIGITAL AV CONNECTIONS

This is the best option for picture and sound! Using the HDMI connection, which has high-definition content protection, provides you with uncompressed digital video and audio, Dolby® Digital 5.1 or PCM sound. This connection requires only one cable. As Real As It Gets!

CONNECTING EXTERNAL EQUIPMENT TO HDMI (INCLUDES HDCP COPY PROTECTION)

To avoid problems with some brands of external equipment, follow this procedure when connecting cables and powering on your equipment.

- 1 Switch off DTV and external equipment before connecting cable. *(Cable is not supplied.)*
- 2 Connect the external equipment's high bandwidth HDMI Output to the DTV's HDMI Input.
- 3 The DTV must be turned on first, press **POWER**. Then turn on your external equipment.
- 4 Press **INPUT** to select **HDMI** to view a digital program.

SET-TOP BOX (Can be a Digital Satellite Receiver, DVD Player, or similar digital device.)

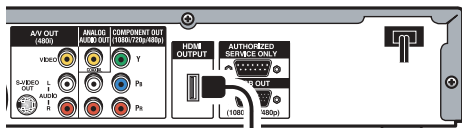

HDMI CABLE
(Gently insert cable into DTV HDMI Input jack.)

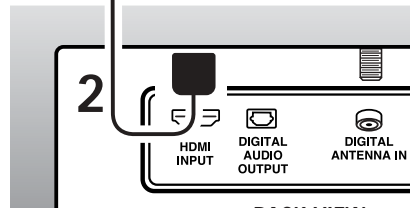

BACK VIEW OF DTV

REMOTE CONTROL

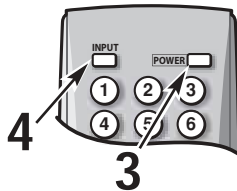

What you will need for connections:

19 Pin HDMI Digital Cable - 1

(Make sure you check the pin configuration of the cable plug-end*)

*Adapter may be required. Check with your local electronics store.

Quick Tips

- If the television HDMI pin configuration is different from the pin configuration on your set-top box, you will need to use an Adapter.
- Press the **INPUT** key after connecting cables to access the AV Inputs. There is NO need to tune to a blank channel.

IMPORTANT NOTE FOR MONITOR USE:

If you did not connect an antenna, you **must** run All Channel Search twice before you can select the AV inputs.

DIGITAL AV CONNECTIONS

CONNECTING STB WITH DVI OUTPUT TO HDMI INPUT

- 1 Switch off DTV and external equipment before connecting cable. *(Cable is not supplied.)*
- 2 Connect the STB's DVI Output to a "DVI to HDMI Cable;" then connect the cable to the DTV's HDMI input.
NOTE: Check with your local electronics store for a DVI to HDMI Cable that matches your equipment and the DTV.
- 3 Connect the STB's Audio L/R to the DTV's VIDEO3 Audio L/R.
- 4 The DTV must be turned on first, press **POWER**. Then turn on your external equipment.
- 5 Press **INPUT** to select *HDMI* to view a digital program.

What you will need for connections:

DVI to HDMI Cable - 1
Audio Cable - 1

REMOTE CONTROL

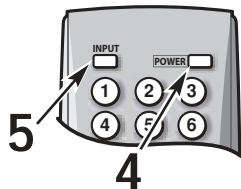

SET-TOP BOX (Can be a Digital Satellite Receiver, DVD Player, or similar digital device.)

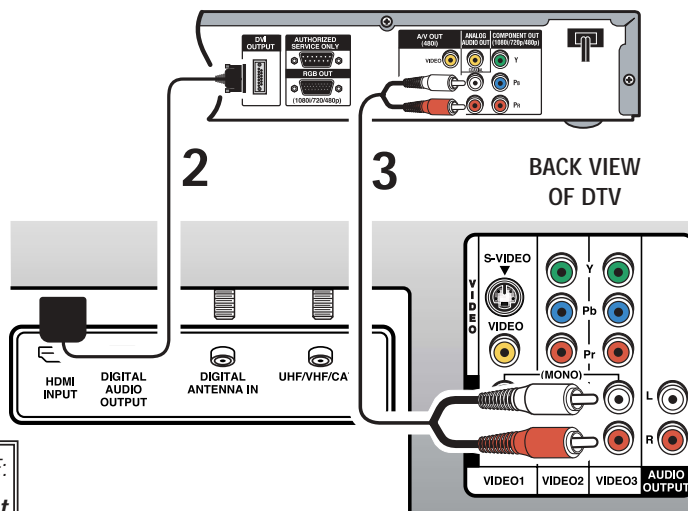

IMPORTANT NOTE FOR MONITOR USE:

If you did not connect an antenna, you **must** run All Channel Search twice before you can select the AV inputs.

Quick Tips

- Press the **INPUT** key after connecting cables to access the AV Inputs. There is NO need to tune to a blank channel.
- With a DVI connection, make sure you connect Audio out to the DTV's VIDEO3 Audio in.
- Because the VIDEO3 audio jacks are used to receive the audio from the DVI device, these video jacks cannot be used when a DVI device is connected.

DIGITAL AV CONNECTIONS

USING COMPONENT JACKS TO CONNECT A DVD PLAYER OR OTHER DIGITAL EQUIPMENT

The Component Video jacks will accept any video content.

Switch off DTV and external equipment before connecting cables. (Cables are not supplied.) Follow these steps to easily connect your STB or **DVD Player** to this DTV:

1 Connect **DVD Player** or similar digital equipment's Component Video Out to the DTV's Video (VIDEO3) jacks.

2 Connect **DVD Player** or similar digital equipment's Audio Out to the DTV's VIDEO3 Audio jacks.

3 Press **POWER** to turn on the DTV, then turn on external equipment.

4 Press **INPUT** to select *Video 3* to view the DVD program.

What you will need for connections:
Component Video Cable - 1
Audio Cable - 1

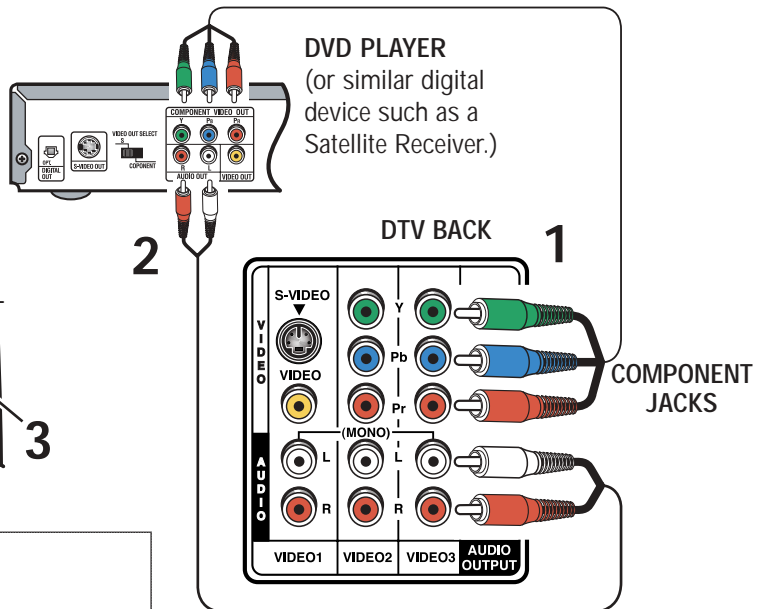
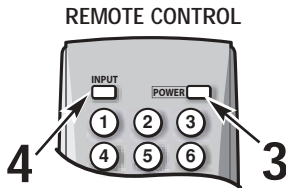

Quick Tips

- VIDEO2 and VIDEO3 jacks have identical functions. Compatible video devices can be connected to either set of jacks.
- Press the **INPUT** key after connecting the cables, to select the *Video 2* or *Video 3* input signal. There is NO need to tune to a blank channel.
- "No Signal" will appear randomly on the screen when no signal is detected at the VIDEO2 or VIDEO3 inputs.

IMPORTANT NOTE FOR MONITOR USE:

If you did not connect an antenna, you **must** run All Channel Search twice before you can select the AV inputs.

DIGITAL AV CONNECTIONS

CONNECTING DIGITAL AUDIO OUT JACK TO A MULTI-CHANNEL RECEIVER

Dolby® Digital Audio provides 5.1 channels of surround sound (five full-range channels [5] and one low-frequency effect channel [.1]). A fiber optics cable is used to carry the 5.1 surround sound (for low-noise signal transfer).

- 1 Using a Fiber Optics cable, connect the DTV's Digital Audio Output to the Digital Audio Input of a Multi-Channel Receiver. (*Fiber optics cable is not supplied.*)
- 2 Press **POWER** to turn on the DTV, then turn on external equipment.

NOTES: When making the connection, do not pinch or kink the fiber optics cable.

Red light visible at the Digital Audio Output does not necessarily indicate that Dolby® Digital 5.1 audio is available. Digital audio is made up of light pulses that the human eye cannot detect. Dolby® Digital 5.1 audio is available at the Digital Audio Output only when received as part of a Digital signal.

IMPORTANT NOTE FOR MONITOR USE:

*If you did not connect an antenna, you **must** run All Channel Search twice before you can select the AV inputs.*

Quick Tips

- Position your DTV at least 2 feet from stereo speakers. The magnets in the speakers may affect the picture quality.

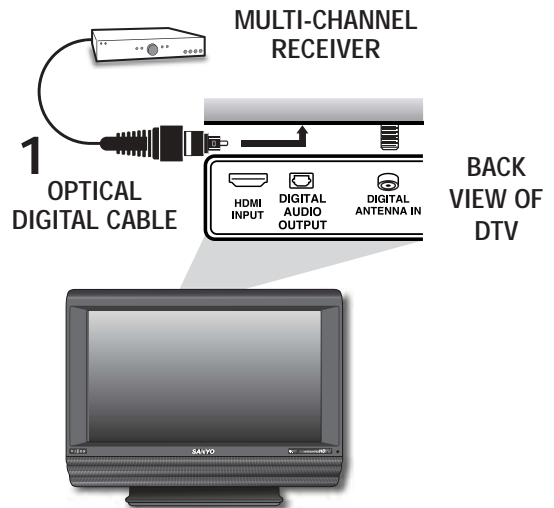

REMOTE CONTROL

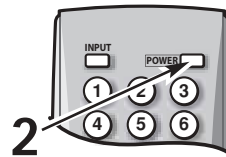

What you will need for connections:

Optical Cable – 1

ANALOG AV CONNECTIONS

USING THE ANALOG VIDEO JACKS TO CONNECT A VCR (OR OTHER ANALOG DEVICE)

Switch off DTV and external equipment before connecting cables. (Cables are not supplied.)

- 1 Connect VCR's Audio Video Out to the DTV's VIDEO1 jacks.

NOTE: For Mono VCR (Single Audio Jack), connect VCR Audio Out to DTV Audio (L) Input.

- 2 *Optional* Connect VCR's S-Video Out to the HDTV's S-Video In Jack.

NOTE: S-Video jack connections override VIDEO1 Video jack connection.

- 3 Press **POWER** to turn on the DTV, then turn on external equipment.

- 4 Press **INPUT** to select **Video 1** to view the VCR program.

Video 1

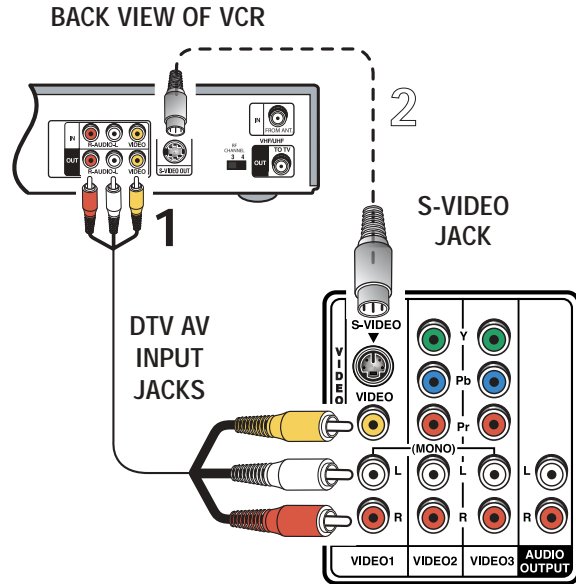

IMPORTANT NOTE FOR MONITOR USE:

If you did not connect an antenna, you **must** run All Channel Search twice before you can select the AV inputs.

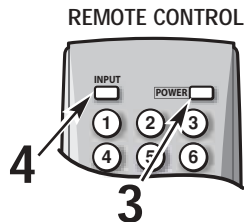

NOTES: *Don't be fooled by the phrase "Available in High-Definition." Composite jacks offer only 480i (SDTV) resolution.*

To view available High-Definition (HD) programs, you must connect your HD equipment to the Component or HDMI jacks.

Quick Tips

- Press the **INPUT** key after connecting cables to access the VIDEO1 input. There is NO need to tune to a blank channel.
- "No Signal" will appear randomly on the screen when no signal is detected at the VIDEO1 video jack.

What you will need for connections:

- Audio Video Cable – 1
- S-Video Cable – 1

ANALOG AV CONNECTIONS

CONNECTING ANALOG AUDIO OUT JACKS TO A STEREO AMPLIFIER

Switch off DTV and external equipment before connecting cables. (Cables are not supplied.)

- 1 Connect the DTV Audio Out (R/L) to the Stereo Amplifier In (R/L).
- 2 Press **POWER** to turn on the DTV, then turn on external equipment.

NOTE: Do not connect external speakers directly to the DTV.

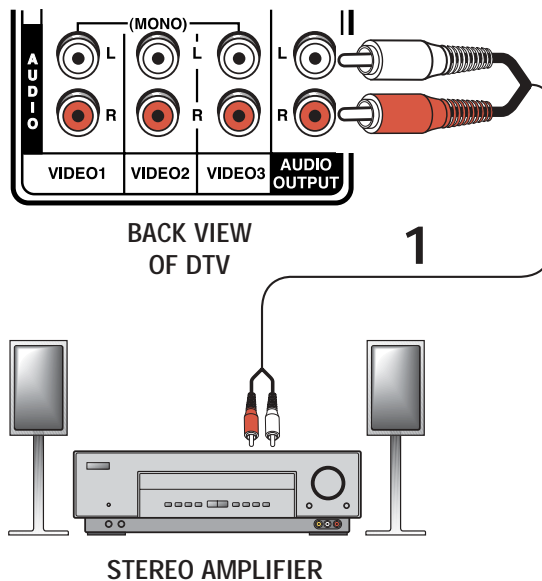
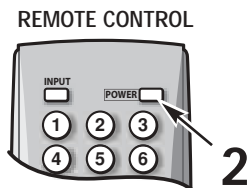

Quick Tips

- Position your DTV at least 2 feet from stereo speakers. The magnets in the speakers may affect the picture quality.

USING THE REMOTE CONTROL



PRECAUTIONS

To ensure safe operation, please observe the following precautions:

Replace both batteries at the same time. Do not use a new battery with a used battery.

Risk of explosion, if battery is replaced by an incorrect type.

Do not expose the Remote Control Unit to moisture or heat.

REMOTE CONTROL KEYS

① **Input Key**—Press to change the input signal source as follows: Analog RF ➔ Digital RF ➔ Video 1 ➔ Video 2 ➔ Video 3 ➔ HDMI ➔ Analog RF.

② **Number Keys**—Two keys must be pressed to select a direct channel. *Example:* Press **0** then **6** to select channel 6.

For Analog Cable channels above 100, press and hold the 1 key until C1-- appears, then press the other two numbers.

③ **Info Key**—Press to display the Digital and Analog Full Banner information (press again to remove the display).

Digital Full Banner display—Contains a two-part Channel Number (Major and Minor), and Tuner ID. If available the following is also included: Station ID, V-Chip Program Rating, Program Title, Audio Info, and Signal Strength.

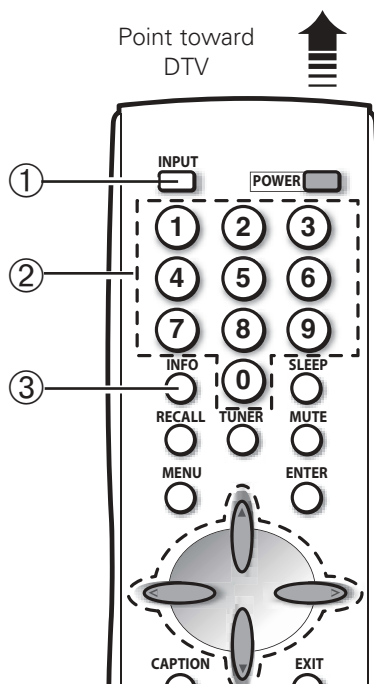
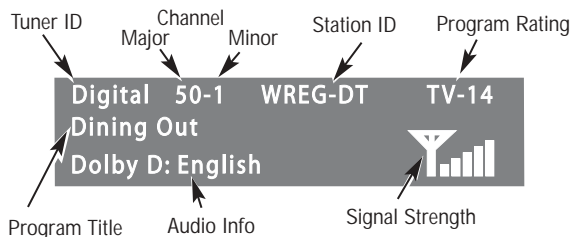

Analog Full Banner display—Contains the Channel Number (analog antenna/cable), Tuner ID, Station ID (if available), Program Title (if available), V-Chip Program Rating, and Audio Info.

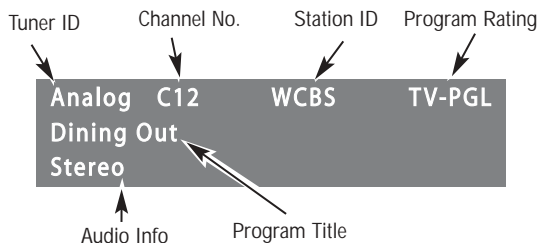

(Continued on page 18.)

REMOTE CONTROL KEYS (CONTINUED)

- ④ **Recall Key**—Select the first channel you want to watch; then select another channel using the **NUMBER** keys. Press **RECALL** to switch between the channels.

*NOTE: The **RECALL** key cannot toggle between a Digital channel and an Analog channel. See **TUNER (#6)** key description.*

- ⑤ **Menu key**—Press this key to display the on-screen menu.

- ⑥ **Tuner Key**—Use this key to toggle from one tuning system to another, digital channels and analog channels.

*NOTE: The **TUNER** key is inactive when an external input is selected (Video 1, Video 2, Video 3, or HDMI).*

- ⑦ **Caption Key**—Press to select analog or digital captioning. The Analog Caption modes are: CC1 ~ CC4, Quikcap, and OFF. The Digital Caption modes are: Digital CC1 ~ CC6, Quikcap, and OFF.

- ⑧ **Channel Scanning (CH ▲▼) Keys**—Press ▲ (up) ▼ (down) keys to tune to the next higher or lower channel in the Channel Scan Memory list. The scanning loop includes analog channels, digital channels, and all AV inputs.

- ⑨ **Pix Shape Key**—Use this key to change the video display format. Available options depend on signal received and the broadcast's aspect ratio. They may include: *PIX1*, *PIX2*, *PIX3*, and *PIX4*. See simulated DTV images below.



PIX1

Gray colored borders appear at the sides of the screen.

Note: 4:3 image without distortion on a 16:9 screen.



PIX2

A 16:9 image fills the screen normally. A 4:3 image is stretched horizontally and may appear distorted.



PIX3

Enlarges a Pix2 image vertically (some of the image may be cropped off).



PIX4

Stretches the Pix3 image horizontally (portions of the sides and/or top and bottom may be cropped off).

- ⑩ **Audio Key**—Press to select the desired audio mode (if available): DIGITAL: Main, Sub1, Sub2, Sub3, etc.; ANALOG: Stereo, Mono, SAP.

- ⑪ **Power Key**—Press to turn DTV on or off.

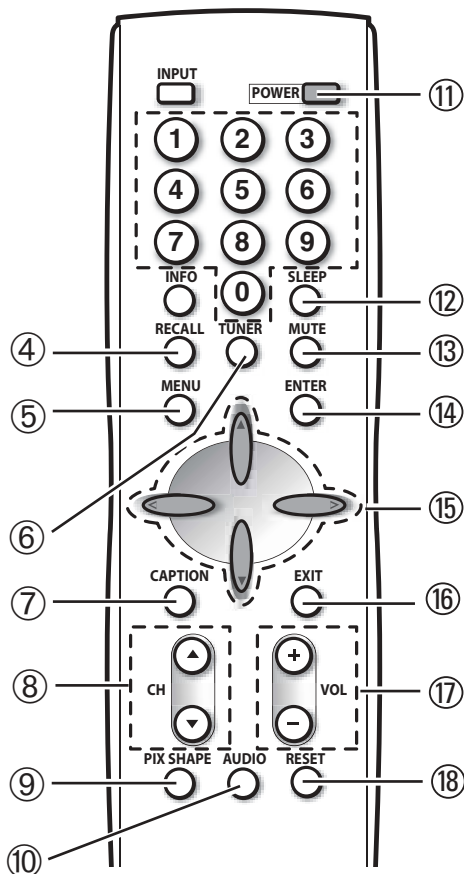

- ⑫ **Sleep Key**—Press this key, then press the “0” key to set the Sleep Timer. The desired time can be set from 30 minutes up to 3 hours in 30 minutes increments. Sleep Timer will switch off the DTV automatically.

NOTE: The Sleep Timer cancels when the DTV is turned off or if a power failure occurs.

- ⑬ **Mute Key**—Press once to minimize the volume. Press again to restore.

*NOTE: This key **will not** mute sound from the audio out jacks.*

- ⑭ **Enter Key**—Press this key to select an option from the menu system, when required.

- ⑮ **Cursor ▲ (up) ▼ (down) keys**—Press these keys to move the cursor up and down within the menu.

Cursor < (left) > (right) keys—Press these keys to move the cursor left and right within the menu.

- ⑯ **Exit Key**—Press this key to exit from the menu system.

- ⑰ **Volume (VOL - +) Keys**—Press the - + keys to adjust volume. The screen displays a left or right red arrow that blinks as many times as you press the **Vol - +** keys.

- ⑱ **Reset Key**—Press twice to restore factory settings. The DTV will automatically start Channel Search and clear all customized settings.

NOTE: The Reset Function includes a channel search. Current Digital and Analog channel databases will be deleted and new ones created by the Channel Search process. To receive Digital Cable channels, see page 21 for Digital Cable Search.

These features will reset to factory defaults:

- Picture/Sound Adjustments: Color, Tint, Contrast, Brightness, Sharpness, and Tone
- Channel Memory—Digital/Analog channel databases will be replaced
- Analog Audio to Stereo
- Captioning to OFF
- V-Guide to OFF
- Menu Language to English
- Sleep Timer to OFF (if previously set)
- Any Video mode to DTV mode

If desired, personal settings can be made again using the menu options.

*IMPORTANT NOTE FOR MONITOR USE:
If you did not connect an antenna, you **must** run All Channel Search twice before you can select the AV inputs.*

DTV ADJUSTMENT AND SETUP

HOW TO OPERATE THE MENU

The on-screen menu system provides the viewer with easy access to adjustments and settings. Just use the **MENU**, **CURSOR**, **ENTER**, and **EXIT** keys on the remote control and follow the on-screen instructions. Generally, you will use the **CURSOR** ▲▼ keys to select a menu item and the **CURSOR** < > keys to make an adjustment. The **ENTER** key confirms a setting. Press the **EXIT** key to return to normal DTV viewing.

MENU NAVIGATION MAP

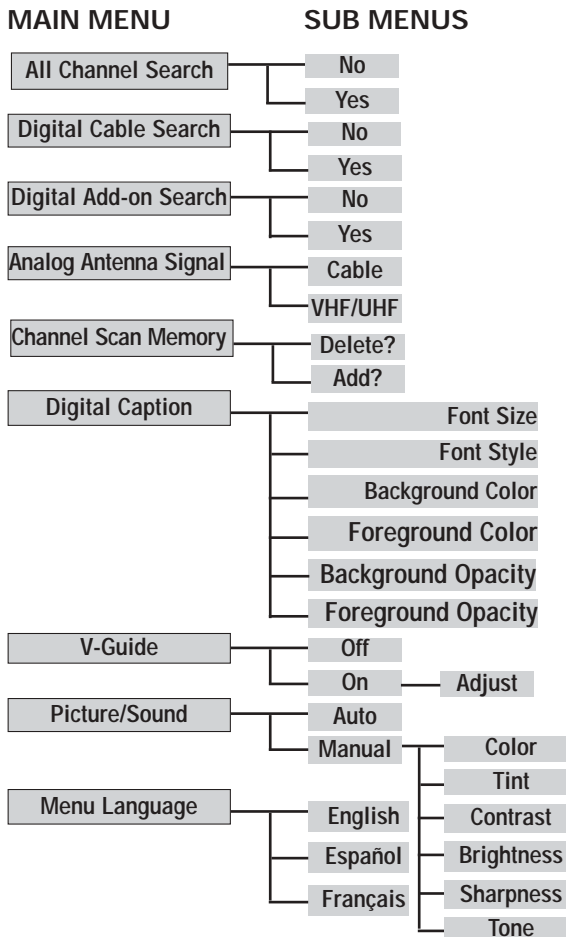

IMPORTANT FACTS:

Some Menu options are specific to Digital and Analog signals and will vary accordingly.

Also, some options are not available in combination. Unavailable options will appear "grayed-out" in the menu. For example, Analog Antenna Signal is not available when tuned to a Digital Channel.

ALL CHANNEL SEARCH

Use All Channel Search to replace existing Digital and Analog Channel databases, such as, if you move to another city.

*NOTES: During All Channel Search, current Digital and Analog channel databases are deleted and new ones created. To receive Digital Cable channels, if available, you **must** perform a Digital Cable Search.*

To add new digital channels to the existing database, use Digital Add-on Search, see page 22.

- 1 Press the **MENU** key to display the Main menu.
- 2 Use the **CURSOR** ▲▼ keys to highlight (green) *All Channel Search*. Press **ENTER**.
- 3 Use the **CURSOR** ▼ key to select *Yes*. Press **ENTER**.

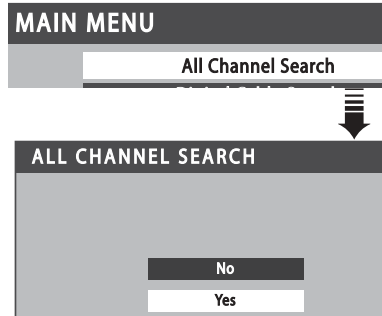

DIGITAL CABLE SEARCH (OPTIONAL)

This DTV can receive unscrambled (ClearQAM) digital cable channels, when available. However, not all cable companies provide ClearQAM digital channels.

Searching for digital cable channels will take about 10 minutes, please be patient.

- 1 Connect a Digital Cable signal directly to the DTV Digital Antenna In Terminal. 
- 2 Press the **TUNER** key to select the Digital Tuner.
- 3 Press the **MENU** key to display the Main menu.
- 4 Use the **CURSOR** ▲▼ keys to highlight (green) *Digital Cable Search*. Press **ENTER**.
- 5 Use the **CURSOR** ▼ key to select Yes. Press **ENTER**.

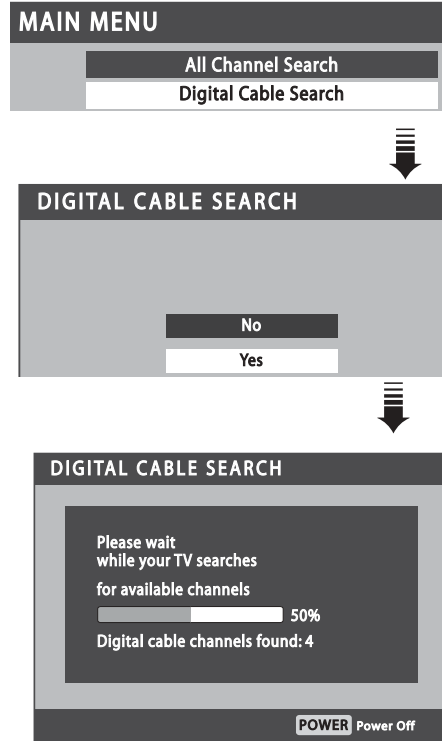

NOTE: After Channel Search is complete, the DTV will tune to the lowest Digital Cable channel (or lowest Analog channel if no Digital Cable channel is found).

IMPORTANT FACT: This DTV maintains only one database of digital channels. Therefore, when you search for ClearQAM digital cable channels, the database of antenna digital channels will be deleted. You will only be able to receive those ClearQAM channels your cable company provides.

Cable companies rearrange virtual channels as programming changes, which may cause the program you are watching to move to another channel. This message will appear on the screen briefly to notify you of a change. You will have to relocate the program you were watching by scanning through the channels.

Program change
from cable company

To restore the antenna digital channel database, reconnect the antenna and use the menu system to perform an All Channel Search.

DIGITAL ADD-ON SEARCH

Use this feature to add new channels to the digital antenna channel database. Also, use this feature to add channels when broadcast towers are in multiple directions from your location.

- 1 Press the **TUNER** key to select the Digital Tuner.
- 2 Press the **MENU** key to display the Main menu.
- 3 Use the **CURSOR ▲▼** keys to highlight (green) *Digital Add-On Search*. Press **ENTER**.
- 4 Use the **CURSOR ▼** key to select Yes. Press **ENTER**.

NOTES: Turn your Antenna and repeat these steps for each direction in which there are transmitting towers.

Go to www.antennaweb.org and type in your zip code to obtain specific tower and antenna information.

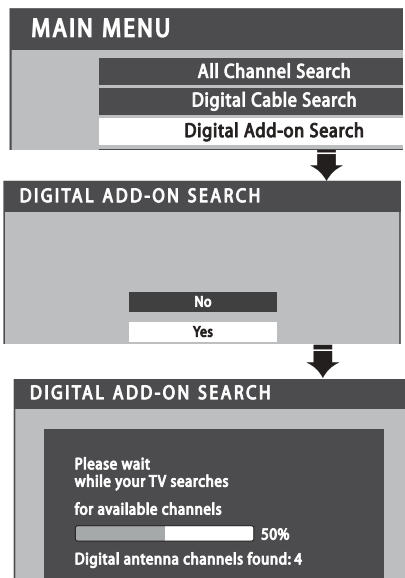

NOTE: If the DTV is switched off by pressing the **POWER** key or unplugging the AC during Digital Add-On Search, all channel information detected before the power loss occurred will be saved.

ANALOG ANTENNA SIGNAL

Use this feature to switch between analog off-air channels and analog cable channels.

- 1 Press the **TUNER** key to select analog channels.
- 2 Press the **MENU** key to display the Main menu.
- 3 Use the **CURSOR ▲▼** keys to highlight (green) *Analog Antenna Signal*. Press **ENTER**.
- 4 Use the **CURSOR ▲▼** keys to choose *Cable* or *VHF/UHF*. Press **ENTER**.
- 5 Press the **EXIT** key to return to normal DTV viewing.

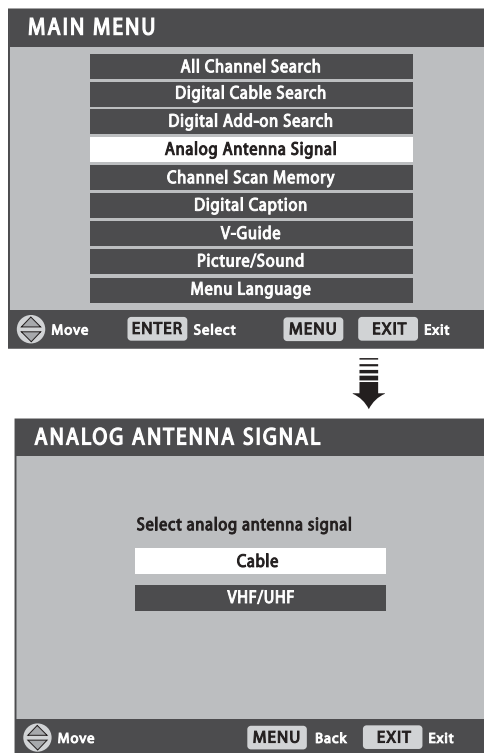

CHANNEL SCAN MEMORY

Channel Scan Memory is a list of active channels that you can scan through using the **CHANNEL SCAN CH ▲** (up) **CH ▼** (down) keys. This list can be customized by deleting and/or adding channels.

- 1 Press the **MENU** key to display the Main menu.
- 2 Use the **CURSOR ▲▼** keys to highlight (green) *Channel Scan Memory*. Press **ENTER**.

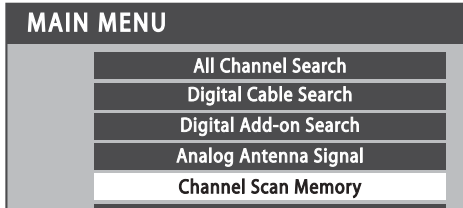

TO DELETE CHANNELS FROM THE CHANNEL SCAN MEMORY

- 3 Use the **CHANNEL (CH ▲▼)** keys or numerical keys to select desired channel. HINT: Press the **TUNER** key to switch between Digital and Analog Channel Scan memories.
- 4 Press the **ENTER** key to delete the channel. The display will change to "deleted."

NOTES: "Delete?" will appear below the channel number if the selected channel is already in the Channel Scan Memory.

Use the Number keys to tune to active channels not in the Channel Scan Memory list.

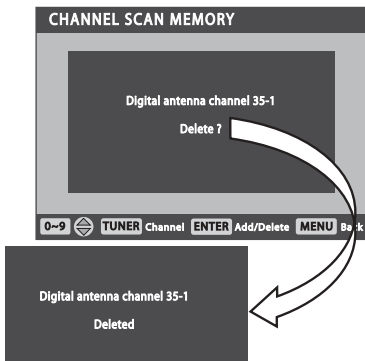

TO ADD A CHANNEL TO THE CHANNEL SCAN MEMORY

- 3 Use the numerical keys **0 ~ 9** to select desired channel number. "Add?" will appear below the channel number. HINT: Press the **TUNER** key to switch between Digital and Analog Channel Scan memories.
- 4 Press the **ENTER** key to add the channel. The display will change to "Added."

When you have finished adding and/or deleting channels, press the **EXIT** key to return to normal DTV viewing.

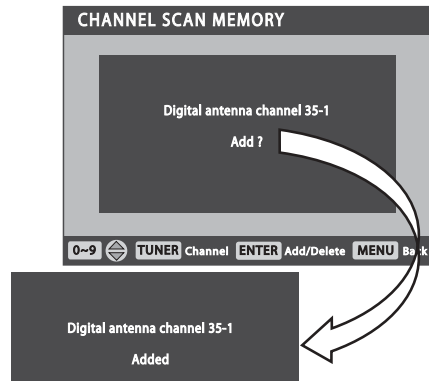

Quick Tips

- When a digital channel is deleted, all of that channel's sub-channels are deleted as well.
- Only previously deleted digital channels can be added back to the Channel Scan Memory.
- If one digital sub-channel is added back to the Channel Scan Memory all of that channel's sub-channels will be added back.
- If the last remaining digital channel is deleted, the entire previous Channel Scan Memory list will be restored automatically.
- If the last remaining analog channel is deleted (cable or off-air channel), ALL analog channels (cable or off-air) will be restored automatically, regardless of the previous Analog Channel Scan Memory list.

DIGITAL CAPTION

Closed-Captioning is hidden textual information transmitted along with the picture and sound. Turning Captioning ON causes the DTV to open these captions and superimpose them on the screen. Because different types of closed-captions can be transmitted with the picture and sound, separate captioning modes are provided. The captioning modes recognized by this model are: Analog EIA-608B and Digital EIA-708B. Local broadcasters decide which caption signals to transmit.

CHANGING THE LOOK OF DIGITAL CAPTIONS

This *Font Size*, *Font Style*, *Background Color*, *Foreground Color*, *Background Opacity*, and *Foreground Opacity* of Digital Captions can be changed.

NOTES: If Background Opacity is set to transparent, captions may be difficult to see.

Only true EIA 708B Digital Closed-Captions are affected by all of these settings.

Analog captions generally will not respond to these adjustments, however, upconverted analog captions may respond to some options.

- 1 Press the **TUNER** key to select the Digital Tuner.
- 2 Press the **MENU** key to display the Main menu.
- 3 Use the **CURSOR ▲▼** keys to highlight (green) *Digital Caption*. Press **ENTER**.
- 4 Use the **CURSOR ▲▼** keys to highlight (green) an option. Press **ENTER**.
- 5 Use the **CURSOR ▲▼** or **< >** keys to select the desired effect.
- 6 When you have finished making adjustments, press the **EXIT** key to return to normal TV viewing.

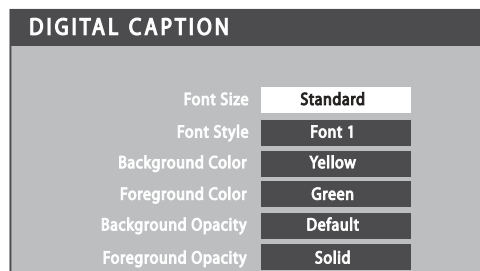
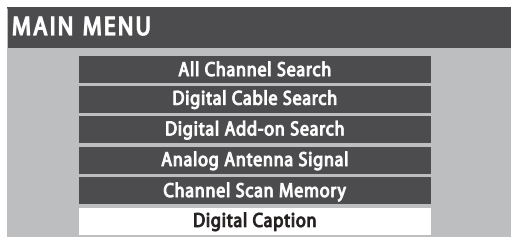

TO VIEW CAPTIONS

- 1 Press the **CAPTION** key to select caption modes.
Digital modes: Digital CC1 through Digital CC6, QuikCap, and Off.
Analog modes : CC1 through CC4, QuikCap, and Off.



Digital Caption



Analog Caption

QUIKCAP OPERATION

QuikCap turns captioning on and off with the *Mute* function. Press the **MUTE** key on the remote control to block the TV sound; the captions display automatically, if available. Press the **MUTE** key again to restore the sound. Captions will disappear.

V-GUIDE (PARENTAL CONTROL)

NOTE: THIS FEATURE IS DESIGNED TO COMPLY WITH THE UNITED STATES OF AMERICA'S FCC V-CHIP REGULATIONS. THEREFORE, IT MAY NOT FUNCTION WITH BROADCASTS THAT ORIGINATE IN OTHER COUNTRIES.

This Sanyo television is equipped with an electronic V-Chip to interpret MPAA (Motion Picture Association of America) and DTV Parental Guidelines rating codes. When these codes are detected, the DTV will automatically display or block the program, depending upon choices you make when setting up the V-Guide system. Content ratings are represented by the initials: FV (fantasy violence), L (adult language), S (sexual situations), V (violence), and D (suggestive dialog).

This television can be set to block programs with content you deem as inappropriate for your children to view.

TO BLOCK MPAA MOVIE OR TV PROGRAM

- 1 Press the **MENU** key to display the Main menu.
- 2 Use the **CURSOR** ▲▼ keys to highlight (green) *V-Guide*. Press **ENTER**.
- 3 Use the **CURSOR** ▲▼ keys to select *ON*. Press **ENTER**.

TO SETUP V-GUIDE RATINGS

- 4 Use the **CURSOR** ▼ to select *Adjust*. Press **ENTER**.
- 5 Press **CURSOR** ▲▼ and < > keys to select MPAA, TV Rating, or Content Ratings. (A green square will appear beside the selected item.)
- 6 Press the **ENTER** key to Block or Unblock selected option. A lock () will appear beside the selected rating option indicating it is blocked.

- 7 When you have finished making adjustments, press the **EXIT** key to return to normal DTV viewing.

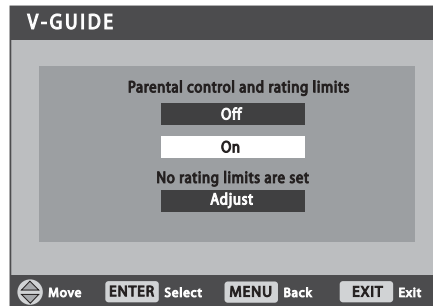

V-GUIDE RATINGS—AT-A-GLANCE

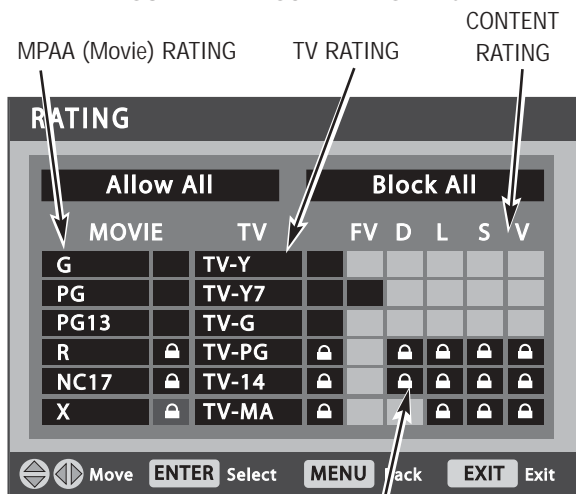

BLOCKED RATINGS
(Lock symbol)

IMPORTANT FACT: The DTV will automatically block ratings above or unblock ratings below a selection. For example, if you block DTV-PG, ratings DTV-14 and DTV-MA will be blocked automatically; or if you block Movie rating PG-13, ratings R, NC17, and X will be blocked automatically.

Blocking TVY7 **does not** block higher ratings.

(Continued on next page.)

V-GUIDE (PARENTAL CONTROL) CONTINUED

TO TEMPORARILY UNBLOCK MPAA MOVIE OR TV PROGRAM

- 1 Press the **MENU** key to display the Main menu.
- 2 Use the **CURSOR ▲▼** keys to highlight (green) *V-Guide*. Press **ENTER**.
- 3 Use the **CURSOR ▲▼** keys to select *OFF*. Press **ENTER**.

This will temporarily set V-Guide to *OFF*. When V-Guide is reset to *ON* (follow steps 1~2), the DTV will automatically revert to previously selected block ratings.

TO UNBLOCK ALL MPAA MOVIE OR ALL TV RATING

- 1 Press the **MENU** key to display the Main menu.
- 2 Use the **CURSOR ▲▼** keys to highlight (green) *V-Guide*. Press **ENTER**.
- 3 Press **ENTER** to select *Adjust*.
- 4 Highlight the "Allow All" option using the **CURSOR ▲▼** and **< >** keys, if needed. Press **ENTER**.

MPAA MOVIE RATINGS (AGE-BASED)

- G** GENERAL AUDIENCES—All ages admitted.
- PG** PARENTAL GUIDANCE SUGGESTED—Some material may not be suitable for children.
- PG-13** PARENTAL GUIDANCE CAUTIONED—Some material may be inappropriate for children under 13.
- R** RESTRICTED—Under 17 requires accompanying parent or adult guardian
- NC-17** NO ONE 17 AND UNDER ADMITTED

TV RATINGS (AGE/CONTENT-BASED)



ALL CHILDREN—Program is designed to be appropriate for children ages 2-6.



DIRECTED TO OLDER CHILDREN—Program is designed for children 7 and above. Material may include mild fantasy violence (FV) or comedic violence.



GENERAL AUDIENCE—Program suitable for all ages. Contain little or no violence, no strong language or sexual dialogue or situations.



PARENTAL GUIDANCE SUGGESTED—Program contains material that may be unsuitable for younger children. Material contains one or more for the following: moderate violence (V), some sexual situations (S), infrequent coarse language (L), or some suggestive dialogue (D).



PARENTS STRONGLY CAUTIONED—Some material is unsuitable for children under 14 years of age. Parents are strongly urged to use caution against letting children under age 14 watch unattended. Material contains intense violence (V), intense sexual situations (S), strong coarse language (L), or intensely suggestive dialogue (D).



MATURE AUDIENCE ONLY—Program is designed to be viewed by adults and therefore may be unsuitable for children under 17 years of age.

Quick Tips

- You can block portions of a DTV rating by choosing one or more of the Content ratings (D, L, S, and V). By blocking just the L and S content ratings of DTV-14, for example, DTV-14 rated programs with a D and/or V content rating could still be viewed.
- V-Guide limits on programming received via the Analog antenna input, Digital antenna input, VIDEO1 Video input, and any 480i signals received through the VIDEO2 or VIDEO3 jacks are controlled by this DTV.
- V-Guide limits on digital programming received through the Component jacks (VIDEO2 or VIDEO3) are controlled by the external devices connected to those jacks (such as a DVD Player or Satellite Receiver). Refer to your external device's owner's manual for instructions on setting V-Guide limits.
- Networks and local stations may or may not include the content ratings portion of the DTV Parental Guidelines.

PICTURE/SOUND ADJUSTMENT

- 1 Press the **MENU** key to display the Main menu.
- 2 Use the **CURSOR ▲▼** keys to highlight (green) *Picture/Sound*. Press **ENTER**.
- 3 Use the **CURSOR ▲▼** keys to highlight (green) *Auto* (factory preset settings) or *Manual*. Press **ENTER**.

MANUAL ADJUSTMENTS

- 4 Use the **CURSOR ▲▼** keys to select the option you want to adjust.
- 5 Then use the **CURSOR < >** keys to make an adjustment.
- 6 When you have finished making adjustments, press the **EXIT** key to return to normal DTV viewing.

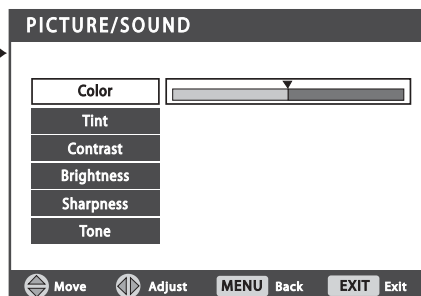
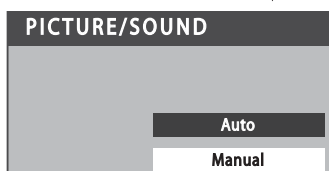
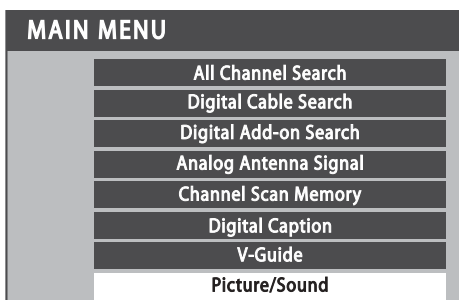

MENU LANGUAGE

- 1 Press the **MENU** key to display the Main menu.
- 2 Use the **CURSOR ▲▼** keys to highlight (green) *Menu Language*. Press **ENTER**.
- 3 Use the **CURSOR ▲▼** keys to select *English*, *Español*, or *Français*.
- 4 Press the **EXIT** key to return to normal DTV viewing.

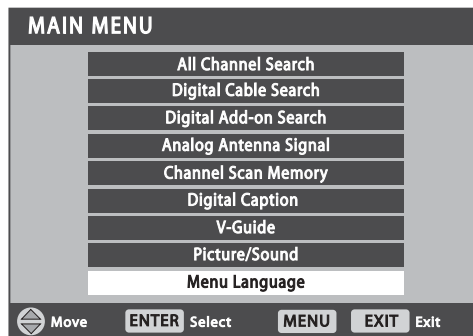

HELPFUL HINTS (Problems/Solutions)

Because of the Quality we build into our product, very few problems are actual DTV defects. Most problems only involve simple hookup or setup changes that can be solved by the customer. Please check the chart below

and try the solutions listed for your problem. If the problem still persists, **before returning your DTV**, please visit our website at www.sanyoctv.com or call us **toll free at 1.800.877.5032. We can Help!**

Problem	Check these Conditions	Try these Solutions	Page No.
DTV turns off automatically.	<ul style="list-style-type: none"> ● The sleep timer may have been set. 	<ul style="list-style-type: none"> ● Press POWER key. 	19
No picture, sound (Digital Picture).	<ul style="list-style-type: none"> ● Check antenna/external connections. ● May be station trouble, NO signal broadcast. ● MUTE function may be on. 	<ul style="list-style-type: none"> ● Adjust antenna. ● Try a different channel. ● Press RESET key to restart channel search. ● Adjust Volume. 	6, 19
No Captioning.	<ul style="list-style-type: none"> ● Check if station is broadcasting a Closed-Caption signal. Select another channel. 	<ul style="list-style-type: none"> ● Press CAPTION key to select Captioning. 	24
Cannot customize Caption.	<ul style="list-style-type: none"> ● Digital Caption signal not broadcast. 	<ul style="list-style-type: none"> ● Press CAPTION key to select Analog captioning. 	24
Cannot display picture on a full screen.	<ul style="list-style-type: none"> ● Check Aspect Ratio of broadcast. 	<ul style="list-style-type: none"> ● Press PIX SHAPE key to change setting. 	18
Pixilation of Digital image.	<ul style="list-style-type: none"> ● Press INFO key and check the signal strength. 	<ul style="list-style-type: none"> ● Turn antenna, install signal booster. ● Install outdoor Digital antenna. 	6, 17
Poor Picture/ Sound.	<ul style="list-style-type: none"> ● Check if program is in color. ● Check antenna/external connections. ● Color or Tint misadjusted. ● May be station trouble. ● MUTE function may be on. 	<ul style="list-style-type: none"> ● Try a different channel. ● Adjust antenna. ● Press RESET key to restart channel search. ● Adjust Volume. 	7, 19, 27
"No Signal" message appears on the screen.	<ul style="list-style-type: none"> ● Check Audio/ Video connections. ● Check external equipment connections. ● Check external equipment setting. 	<ul style="list-style-type: none"> ● Press INPUT key. ● Switch on external equipment. ● Set external equipment output connections to match input connections. 	11 ~ 16

Problem	Check these Conditions	Try these Solutions	Page No.
No DTV Stereo or SAP sound.	<ul style="list-style-type: none"> ● Check if station is broadcasting a true MTS stereo signal or a SAP signal. 	<ul style="list-style-type: none"> ● Press AUDIO key. 	18
No UHF, VHF Channels OK.	<ul style="list-style-type: none"> ● Cable Channel indicator C should not appear next to the channel number. 	<ul style="list-style-type: none"> ● Switch Analog antenna signal to VHF/UHF. 	22
Cannot select or scan some channels.	<ul style="list-style-type: none"> ● Channel may be removed from memory. ● Check antenna connections. ● No digital signal being broadcast. ● Signals are weak. ● V-Guide is set to block programming. 	<ul style="list-style-type: none"> ● Select Channel Scan Memory and manually add channels or start CH. (channel) search. ● Turn Antenna or install signal booster. ● Set V-Guide to "None" or press the RESET key to clear all settings and restart channel search. 	23 25 ~ 26 19
No Cable channels above number 13.	<ul style="list-style-type: none"> ● Cable Channel Indicator C should appear next to channel number. 	<ul style="list-style-type: none"> ● Switch Analog Antenna signal to Cable. 	22
Remote Control will not work DTV.	<ul style="list-style-type: none"> ● Check batteries ● Make sure DTV is plugged in. 	<ul style="list-style-type: none"> ● Replace batteries two "AAA." ● Aim remote control at front of DTV. 	6,17~19
Cabinet makes popping sound.	<ul style="list-style-type: none"> ● This is a normal condition during warm-up and cool down of the plastic cabinet parts. 		

CARE AND CLEANING

CLEANING THE CABINET

The surface of the cabinet can be damaged if not properly maintained. Many common household aerosol sprays, cleaning agents, solvents, and polishes will cause permanent damage to the fine surface.

1. **Unplug the power cord before cleaning the television.**
2. **Clean the cabinet with a soft dry cloth.**

NOTE: Never spray liquids on the screen because they can run down and drip onto the chassis. This may cause component failure not covered under Warranty.



This symbol on the nameplate means the product is Listed by Underwriters' Laboratories Inc. It is designed and manufactured to meet rigid U.L. safety standards against risk of fire, casualty and electrical hazards.

MEXICO GUARANTEE

IMPORTADOR:

**COMERCIALIZADORA MEXICO
AMERICANA, S.DE R.L. DE C.V.
AV. NEXTENGO N° 78
COL. SANTA CRUZ ACAYUCAN
DEL. AZCAPOTZALCO, MÉXICO, D.F. C.P. 02770
RFC: CMA9109119L0**

DESCRIPTION: Television
BRAND: SANYO
MODELS: DP26746
DP32746

GUARANTEE

THE APPARATUS THAT YOU HAVE ACQUIRED HAS A ONE YEAR GUARANTEE FOR MANUFACTURING DEFECTS AND A ONE YEAR SERVICE WARRANTY FROM THE DATE OF PURCHASE GRANTED BY:

COMERCIALIZADORA MEXICO-AMERICANA, S. DE R.L. DE C.V.

UNDER THE FOLLOWING CONDITIONS:

1. TO MAKE THE GUARANTEE EFFECTIVE, SIMPLY SHOW THIS POLICY FILLED OUT BY THE STORE OR SUPPLIER UNIT OR THIS SALES INVOICE, WITH THE APPARATUS IN ANY OF THE SERVICE CENTERS INDICATED ON THIS GUARANTEE.
2. IF THE FAULT IS ATTRIBUTED TO A MANUFACTURING DEFECT, THE APPARATUS WILL BE REPLACED OR YOUR MONEY REFUNDED. DURING THE 30 DAYS SUBSEQUENT TO THE PURCHASE THE GUARANTEE WILL BE VALID AT THE STORE WERE THE APPARATUS WAS PURCHASED, PRESENTING THE ABOVE DOCUMENTS.
3. REPAIR TIME WILL NEVER BE MORE THAN 30 DAYS. IF THIS TIME HAS ELAPSED, AND THE PRODUCT ISN'T REPAIRED, COMERCIALIZADORA MEXICO AMERICANA, S. DE R.L. DE C.V. WILL PROCEED TO EFFECTUATE THE EXCHANGE FOR AN EQUIVALENT APPARATUS OR THE RETURN OF THE BUYING-SALE COST RESPECTIVELY.
4. THIS GUARANTEE WILL COVER ITS TOTALITY OF PIECES, COMPONENTS AND SERVICE REPAIR OF PRODUCT, AND THE RESPECTIVE COST OF TRANSPORTATION.

THIS GUARANTEE WILL BE NULL AND VOID IN THE FOLLOWING CIRCUMSTANCES:

- * WHEN PRODUCT HAS BEEN USED IN A DIFFERENT CONDITION THAN ITS NORMAL USE.
- * WHEN PRODUCT HASN'T BEEN OPERATING CORRECTLY ACCORDING TO THE INSTRUCTIONS IN THIS MANUAL.
- * WHEN PRODUCT HAS BEEN CHANGED OR REPAIRED BY PERSONS NOT AUTHORIZED FROM THE MANUFACTURER, IMPORTER, OR MERCHANT RESPONSIBLE RESPECTIVE.

CENTRO DE SERVICIO Y LUGAR DONDE OBTENER PARTES, COMPONENTES, CONSUMIBLES Y ACCESORIOS:

SUCURSAL VALLEJO	SUCURSAL MINERVA
Poniente 126 N° 288 B	Silos N° 135, Col. Minerva
Col. Nueva Vallejo	Deleg. Iztapalapa
México, D.F.	México, D.F. 09810
Tels. 5567-5378	Tels. 5646-4551
5368-0105, 8589-8033	5646-4550

STAMP, DATE AND SIGNATURE
OF
STORE

DESCRIPTION: TELEVISION **BRAND:** SANYO **MODEL:** _____

CLIENT'S NAME: _____

ADDRESS: _____

EXTERIOR NUMBER: _____ **INTERIOR NUMBER:** _____

SUB DIVISION: _____ **STATE/DELEGATION:** _____

TELEPHONE: _____

30 *Need help?* Visit our Web site at www.sanyoctv.com or Call 1-800-877-5032

UNITED STATES AND CANADA WARRANTY

ONE-YEAR LIMITED WARRANTY

THIS LIMITED WARRANTY IS VALID ONLY ON SANYO TELEVISIONS PURCHASED AND USED IN THE UNITED STATES OF AMERICA, CANADA, AND PUERTO RICO, EXCLUDING THE UNITED STATES' OTHER TERRITORIES AND PROTECTORATES. THIS LIMITED WARRANTY APPLIES ONLY TO THE ORIGINAL PURCHASER, AND DOES NOT APPLY TO PRODUCTS USED FOR INDUSTRIAL OR COMMERCIAL PURPOSES.

FOR ONE YEAR from the date of purchase, Sanyo Manufacturing Corporation will replace any defective TV.

To insure proper warranty exchange, keep the original sales receipt for evidence of purchase. Return the defective TV to the retailer along with the receipt and the included accessories, such as the remote control. The defective TV will be exchanged for the same model, or a replacement model of equal value, if necessary. Replacement model will be contingent on availability and at the sole discretion of Sanyo Manufacturing Corporation.

THE FOREGOING WARRANTY IS EXCLUSIVE AND IN LIEU OF ALL OTHER WARRANTIES OF MERCHANTABILITY OR FITNESS FOR A PARTICULAR PURPOSE.

OBLIGATIONS

For one year from the date of purchase, Sanyo Manufacturing Corporation warrants this product to be free from defects in material and workmanship under normal use and conditions. Should replacement be necessary under this warranty for any reason due to manufacturing defect or malfunction during the first year from date of original purchase, Sanyo Manufacturing Corporation will provide a new TV via exchange at the retailer.

For customer assistance, whether during or out of the warranty period, call toll free 1-800-877-5032.

Weekdays 7:30 AM – 7:00 PM Central Time

Saturday 7:30 AM – 4:00 PM Central Time

This warranty expresses specific contractual rights; retail purchasers may have additional statutory rights which vary from state to state.

(EFFECTIVE: August 1, 2002)

For your protection in the event of theft or loss of this product, please fill in the information requested below and **KEEP IN A SAFE PLACE FOR YOUR OWN PERSONAL RECORDS.**

Model No. _____ Date of Purchase _____

Serial No. _____ Purchase Price _____

(Located on back of unit)

Where Purchased _____



Sanyo Manufacturing Corp.
3333 Sanyo Road, Forrest City, AR 72335

Need help? Visit our Web site at www.sanyoctv.com or Call 1-800-877-5032

Bienvenido al Mundo de SANYO

Gracias por comprar esta televisión digital LCD HDTV. Usted ha hecho una excelente elección por Desempeño, Confiabilidad, Características, Valor, y Estilo.

Información importante

Antes de operar e instalar esta Televisión Digital (DTV), lea este manual completamente. Esta DTV provee muchas características y funciones que pueden ser convenientes para usted. Operar la DTV adecuadamente le permite manejar esas características y mantenerla en buenas condiciones por muchos años.

*Si la DTV aparenta operar inadecuadamente, lea este manual nuevamente, verifique las operaciones y las conexiones de los cables además de tratar alguna de las soluciones mostradas en la sección de “tips de Ayuda” que se muestra en las páginas 62 ~ 63 de este manual. Si el problema persiste, visite nuestro sitio de Internet en www.sanyoctv.com o llame sin costo al 1.800.877.5032. **Nosotros podemos ayudar!***



“Como un Asociado de ENERGY STAR®,” Sanyo Manufacturing Corporation, ha determinado que este producto cumple con los lineamientos en eficiencia energética de ENERGY STAR®.

CHILD SAFETY

Sanyo is committed to making home entertainment safe and enjoyable. Always use an appropriate table or stand when positioning your DTV. Use appropriate brackets, braces, or straps to anchor your furniture in place. But never screw anything directly to the television.

Do not place televisions on dressers, shelves, desks, carts, etc. where curious or excited children could pull, push, or otherwise cause the unit to fall and cause personal injury.

Never place toys or other items on top of the DTV that could pique children's curiosity causing them to climb about the furniture.

Always use stands that are designed to support the size and combined weight of your television and other electronic devices.



SEGURIDAD PARA INFANTES

Sanyo esta comprometido en hacer que su sistema de entretenimiento sea seguro y agradable. Use siempre una mesa o soporte apropiado cuando coloque su televisor. Use soportes, refuerzos o correas para sujetar el mueble en su lugar. NUNCA atornille nada directamente al televisor.

Nunca coloque televisiones en repisas, escritorios, carros, etc. donde niños traviosos pudieran empujar, jalar o hacer de cualquier forma que la unidad se cayera y les causara algún daño.

Nunca coloque juguetes u otros artículos encima de la televisión que puedan llamar la atención de los niños queriendo ellos alcanzarlos ya que pueden trepar en el mueble pudiendo lastimarse.

Siempre use soportes que están diseñados para contener la combinación de peso y tamaño de su televisión y otros artículos eléctricos.



