

ECM40-60

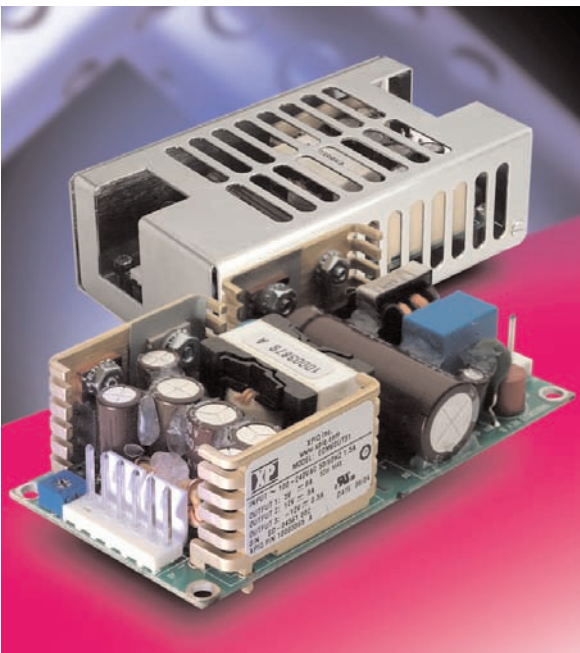

- 40 & 60 Watt Models
- Small Size 2.0" x 4.0" x 1.2"
- Low Leakage Current
- Industrial & Medical Approvals
- Full Load Available Convection Cooled
- Wide Operating Temperature 0 °C to +70 °C
- Level B Conducted Emissions
- EN61000-3-2 Compliant
- Universal AC Input 90-264 VAC
- Input Frequency 47-63 & 440 Hz
- Single & Multiple Outputs
- Cover Kits Available
- Mating Connector & Loom Kits Available

Introduction

Approved for Class I and Class II applications, the ECM range of single and multiple output AC-DC, 40-60 W power supplies from XP feature the world's smallest footprint for units of these ratings. Both are just 2" x 4" (50.8 mm x 101.6 mm) and 1.2" (30.48 mm) high. Furthermore, these high-density power supplies meet EN55022 Level B conducted emissions with maximum leakage currents of 100 μ A at 115 VAC or 200 μ A at 230 VAC. As a result, these switchers are equally suitable for industrial, IT and medical applications, with no price premium for meeting medical requirements.

The ECM40-60 series have single output versions from 5 V to 48 VDC, adjustable by $\pm 10\%$, and dual and triple output versions covering combinations of 3.3 V, 5 V, 12 V, 15 V and 24 V. They are dual-fused for compliance with IEC60601-1 and efficiency is 80-85%, depending upon the model, so minimal excess heat is generated.

The power supplies deliver full power between 0 °C and +50 °C and will operate at up to +70 °C with derating and only 5 CFM of cooling. Comprehensive overvoltage, overload and short circuit protection is built in. Covers, looms and connector kits are available.



T H E X P E R T S I N P O W E R

Input Characteristics

Characteristic	Minimum	Typical	Maximum	Units	Notes & Conditions
Input Voltage - Operating	90		264	VAC	170-370 VDC
Input Frequency	47	50/60	63	Hz	400 Hz operation available
Input Current - No load			41	mA	230 VAC
Input Current - Full load			1.38	A	90 VAC
Inrush Current			40	A	Cold start at 230 VAC
Power Factor		0.62			230 VAC
Earth Leakage Current			290	μA	264 VAC
Input Protection					T3.15 A/ 250 V internal fuse in line & neutral

All specifications are at nominal input, full resistance load at 25°C unless otherwise stated.

Output Characteristics

Characteristic	Minimum	Typical	Maximum	Units	Notes & Conditions
Output Voltage	5.0		48.0	VDC	See modules table
Initial Set Accuracy			V ¹ : ±1, V ² & V ³ : ±5	%	
Output Voltage Trim	±10			%	V ¹ (V ² will track V ¹ by the same %)
Minimum load	V ¹ : 0.5, V ² : 0.1			A	Not required on single output models
Start Up Delay			2	s	90 VAC
Start Up Rise Time			50	ms	
Hold Up Time	16		75	ms	115-230 VAC input
Drift			±0.2	%	
Line Regulation			±0.5	%	90-264 VAC
Load Regulation			±1.0	%	Single output
			V ¹ : ±3, V ² & V ³ : ±5	%	Dual output
Transient Response			4	%	Output voltage recovers to within 1% in less than 500 μs for 50% load change.
Ripple & Noise			1	%pk-pk	20 MHz bandwidth
Overvoltage Protection	115		135	VDC	Recycle input to reset
Overload Protection	110		150	% I _{max}	Auto-recovery
Short Circuit Protection					Trip & restart (hiccup mode)
Temperature Coefficient			0.05	%/°C	

General Specifications

Characteristic	Minimum	Typical	Maximum	Units	Notes & Conditions	
Efficiency	70			%	3.3 & 5 V single output versions	
	80				(at 230 VAC full load)	All other single output versions
	75					Dual output versions
Isolation Voltage		4000		VAC	Input to output	
		1500			Input to ground	
		500			Output to ground	
Switching Frequency		70		kHz	Fixed	
Power Density			6.25	W/In ³	For 60 W version	
Weight		150		g		
MTBF		250		kHrs	MIL-HDBK-217F	

Environmental

Characteristic	Minimum	Typical	Maximum	Units	Notes & Conditions
Operating Temperature	-0		+70	°C	See derating curves
Storage Temperature	-20		+85	°C	
Cooling		0		CFM	Convection-cooled
Operating Humidity			95	% RH	Non- condensing
Operating Altitude			3000	m	
Shock			30	Gpk	Half sine 6 axis
Vibration			2	G	5-500 Hz 3 axis

Electromagnetic Compatibility & Immunity

Standard	Test Level	Criteria	Notes & Conditions
Emissions	EN55022	Class B Conducted & radiated	
	EN60601-1-2	Class B Conducted	
Harmonic Currents	EN61000-3-2		
Voltage Flicker	EN61000-3-3		
ESD Immunity	EN61000-4-2	level 2, performance criteria A	
Radiated Immunity	EN61000-4-3	10 V/m, performance criteria A	
EFT/Burst	EN61000-4-4	level 2, performance criteria A	
Surge	EN61000-4-5	level 3, performance criteria A	
Conducted Immunity	EN61000-4-6	10 Vrms, performance criteria A	
Dips & Interruptions	EN61000-4-11	70% U ^r : performance criteria A	For 10 ms
		30% U ^r : performance criteria A	For 100 ms

Safety Approvals

Standard	Category
UL/cUL 60601-1	File Number: E146893 1st edition (2003)
UL/cUL 60950	File Number: E136109 3rd edition
EN60950	2001
IEC60950	US/8413/UL 1st edition (2001)
IEC60601	US/8386/UL & US/8609/UL
IEC60601-1	2nd edition (1998) amendment nos. 1 & 2

Models & Ratings

Max Power	Outputs						Model Number
	V1	Imin/Imax ⁽³⁾	V2	Imin/Imax	V3	Imin/Imax	
40 W	+5.0 V	0.0 A / 8.0 A					ECM40US05†*
	+7.0 V	0.0 A / 5.7 A					ECM40US07
	+9.0 V	0.0 A / 4.4 A					ECM40US09*
	+12.0 V	0.0 A / 3.5 A					ECM40US12†*
	+15.0 V	0.0 A / 2.7 A					ECM40US15†*
	+18.0 V	0.0 A / 2.2 A					ECM40US18
	+24.0 V	0.0 A / 1.7 A					ECM40US24†*
	+33.0 V	0.0 A / 1.2 A					ECM40US33
	+48.0 V	0.0 A / 0.9 A					ECM40US48†*
	+5.0 V	0.5 A / 6.0 A	+12.0 V	0.1 A / 2.0 A			ECM40UD21
	+5.0 V	0.5 A / 6.0 A	+15.0 V	0.1 A / 1.5 A			ECM40UD22
	+5.0 V	0.5 A / 6.0 A	+12.0 V	0.1 A / 2.0 A	-12.0 V	0.0 A / 0.5 A	ECM40UT31†*
	+5.0 V	0.5 A / 6.0 A	+24.0 V	0.1 A / 1.0 A	-12.0 V	0.0 A / 0.5 A	ECM40UT32†
	+5.0 V	0.5 A / 6.0 A	+15.0 V	0.1 A / 1.5 A	-15.0 V	0.0 A / 0.5 A	ECM40UT33†*
	+3.3 V	0.5 A / 6.0 A	+5.0 V	0.1 A / 1.5 A	+12.0 V	0.0 A / 0.5 A	ECM40UT34†*
	+5.0 V	0.5 A / 6.0 A	+3.3 V	0.1 A / 1.5 A	+12.0 V	0.0 A / 0.5 A	ECM40UT35†

Max Power	Outputs						Model Number
	V1	Imin/Imax ⁽³⁾	V2	Imin/Imax	V3	Imin/Imax	
60 W	+5.0 V	0.0 A / 12.00 A					ECM60US05†*
	+7.0 V	0.0 A / 8.60 A					ECM60US07
	+9.0 V	0.0 A / 6.70 A					ECM60US09*
	+12.0 V	0.0 A / 5.00 A					ECM60US12†*
	+15.0 V	0.0 A / 4.00 A					ECM60US15†*
	+18.0 V	0.0 A / 3.30 A					ECM60US18
	+20.0 V	0.0 A / 3.00 A					ECM60US20
	+24.0 V	0.0 A / 2.50 A					ECM60US24†*
	+33.0 V	0.0 A / 1.80 A					ECM60US33
	+48.0 V	0.0 A / 1.25 A					ECM60US48†*
	+5.0 V	0.5 A / 8.00 A	+12.0 V	0.1 A / 3.0 A			ECM60UD21
	+5.0 V	0.5 A / 8.00 A	+15.0 V	0.1 A / 2.5 A			ECM60UD22
	+5.0 V	0.5 A / 8.00 A	+12.0 V	0.1 A / 3.0 A	-12.0 V	0.0 A / 0.5 A	ECM60UT31†*
	+5.0 V	0.5 A / 8.00 A	+24.0 V	0.1 A / 1.5 A	-12.0 V	0.0 A / 0.5 A	ECM60UT32†
	+5.0 V	0.5 A / 8.00 A	+15.0 V	0.1 A / 2.5 A	-15.0 V	0.0 A / 0.5 A	ECM60UT33†*
	+3.3 V	0.5 A / 8.00 A	+5.0 V	0.1 A / 1.5 A	+12.0 V	0.0 A / 0.5 A	ECM60UT34†*
+5.0 V	0.5 A / 8.00 A	+3.3 V	0.1 A / 1.5 A	+12.0 V	0.0 A / 0.5 A	ECM60UT35†	

Notes

- V2 will track a change in V1 by the same percentage change in voltage as V1 is trimmed.
- To receive unit with cover fitted, add suffix '-C' to model number. For Class I operation only.
- A 120% peak load can be taken for up to 100 ms with a 25% duty cycle. Average load not to exceed maximum power rating.

† Available from Farnell InOne.

*Available from Newark InOne.

Thermal Derating Curves

All ECM40 models convection-cooled

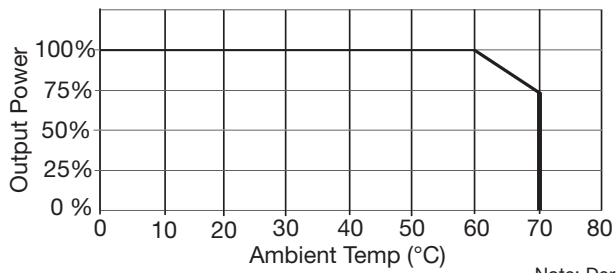

Note: Derate by 10% if cover is fitted

All ECM40 models with 5 CFM

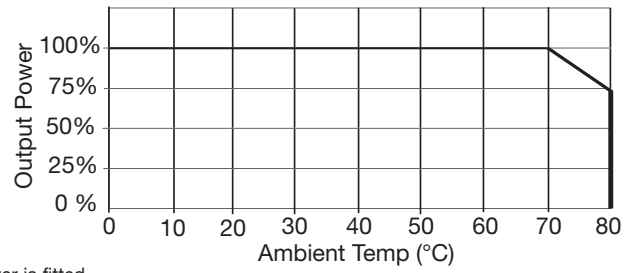

All ECM60 models convection-cooled

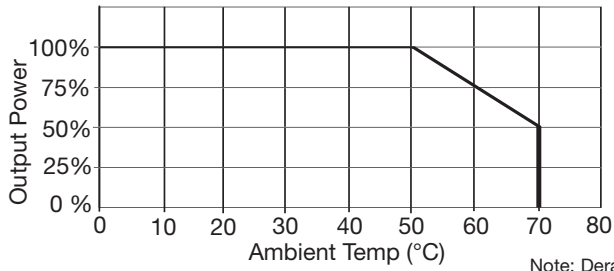

Note: Derate by 10% if cover is fitted

All ECM60 models with 5 CFM

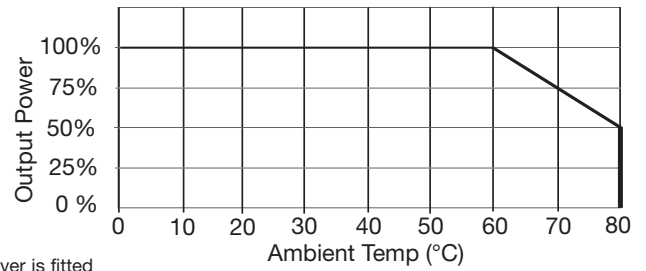

Transient Response

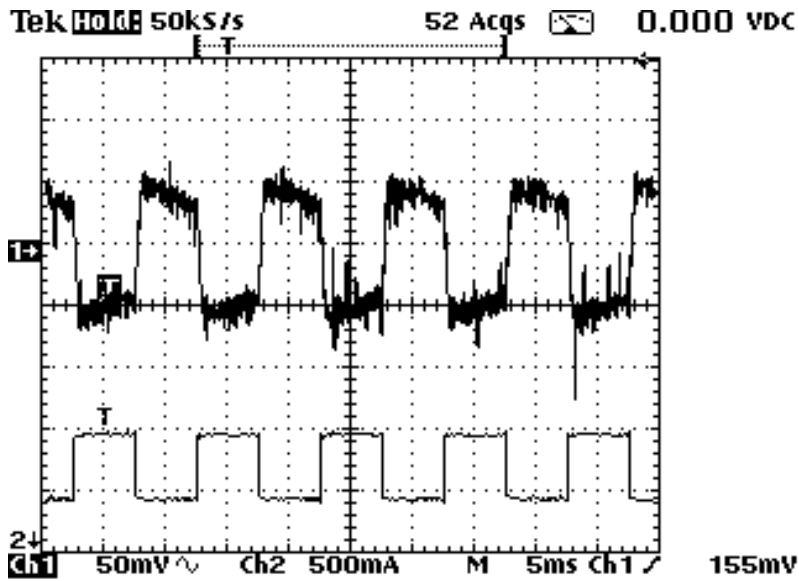

ECM60US24 25% load change

Efficiency Versus Input Voltage

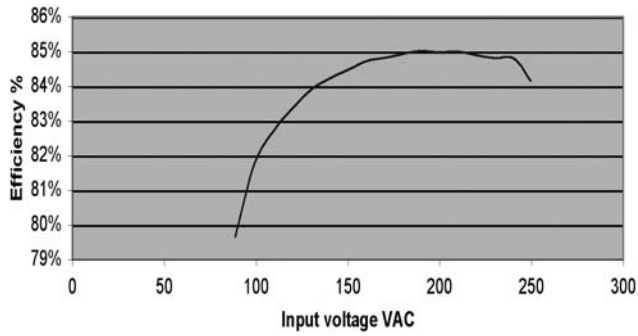

ECM60US24 with 60 W load

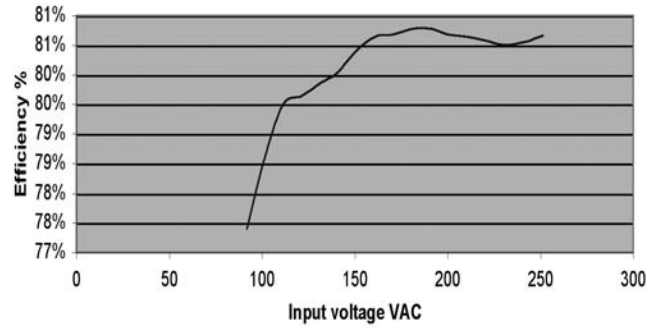

ECM60UT33 with 50 W load

Efficiency Versus Output Load

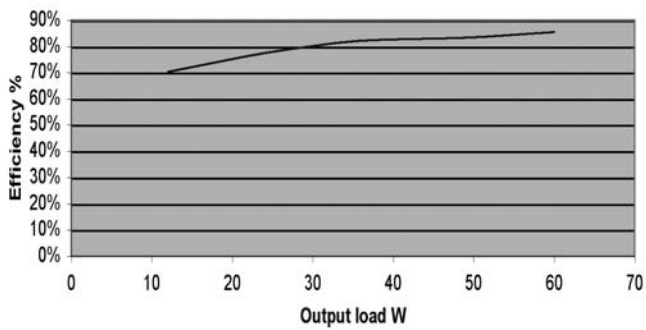

ECM60US24 at 230 VAC input

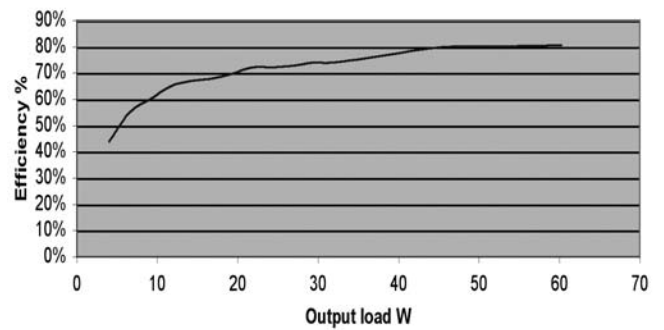

ECM60UT33 at 230 VAC input

Start Up Delay

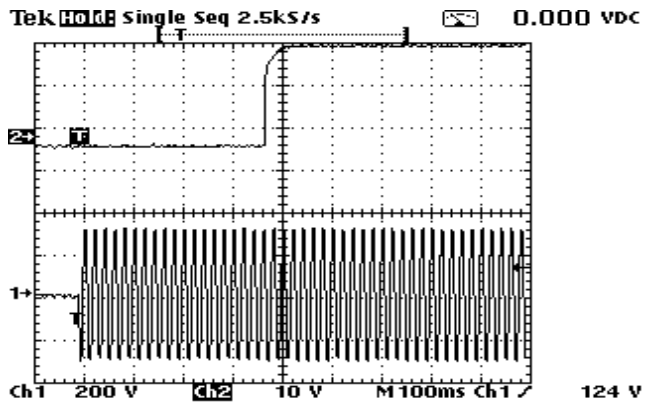

ECM60US24 with 60 W load

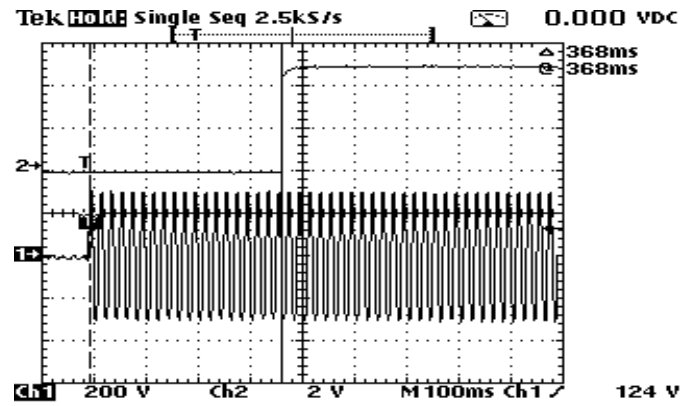

ECM60UT33 with 60 W load

Hold Up Tme

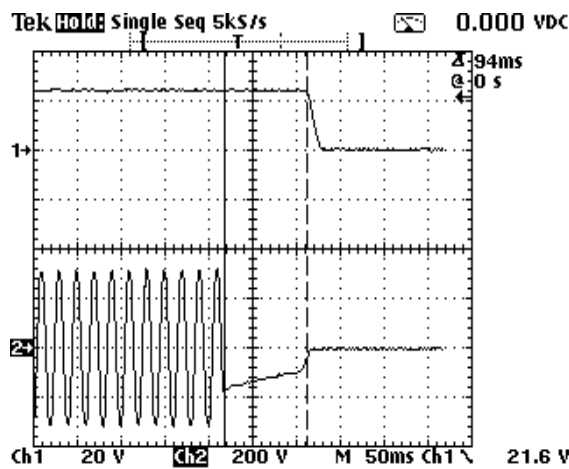

ECM60US24 with 60 W load at 230 VAC

Overload Characteristics

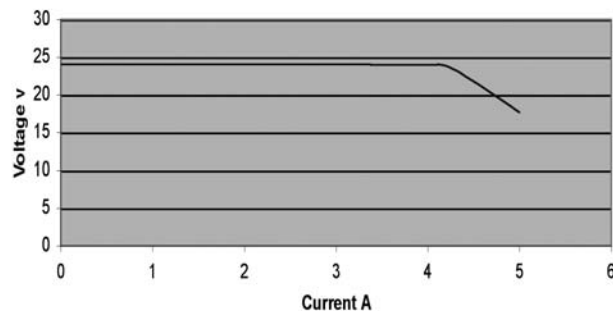

ECM60US24. When current reaches 5.4 A, output goes into trip and restart (hiccup) mode

Ripple & Noise

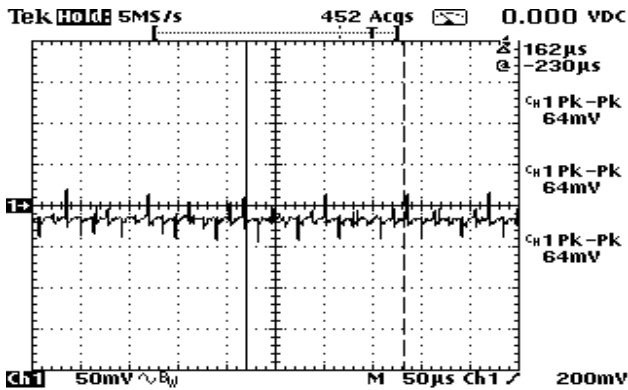

ECM60US24 with 60 W load
 Noise measured is 64 mV pk-pk

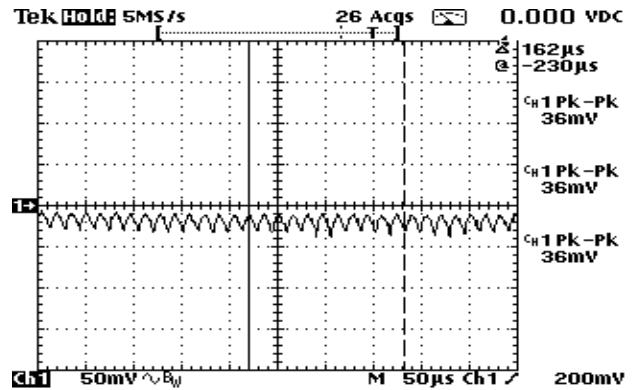

ECM60UT33 output 1 with 30 W load.
 Noise measured is 36 mV pk-pk

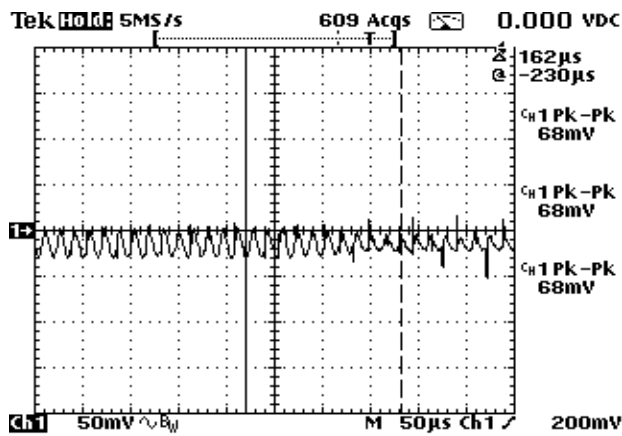

ECM60UT33 output 2 with 15 W load.
 Noise measured is 68 mV pk-pk

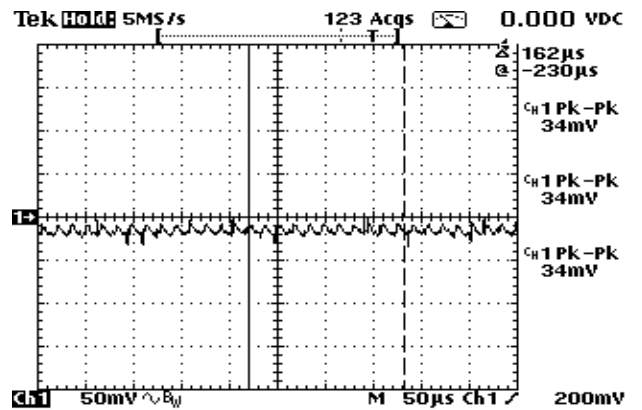

ECM60UT33 output 3 with 7 W load.
 Noise measured is 34 mV pk-pk

Conducted Noise

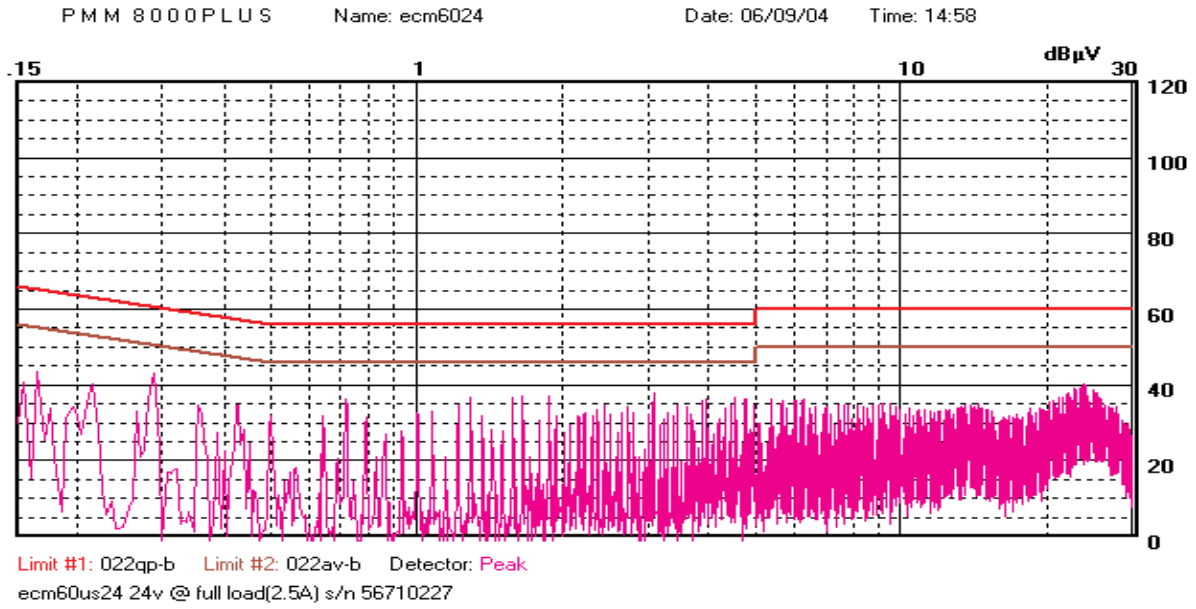

ECM60US24 at full load

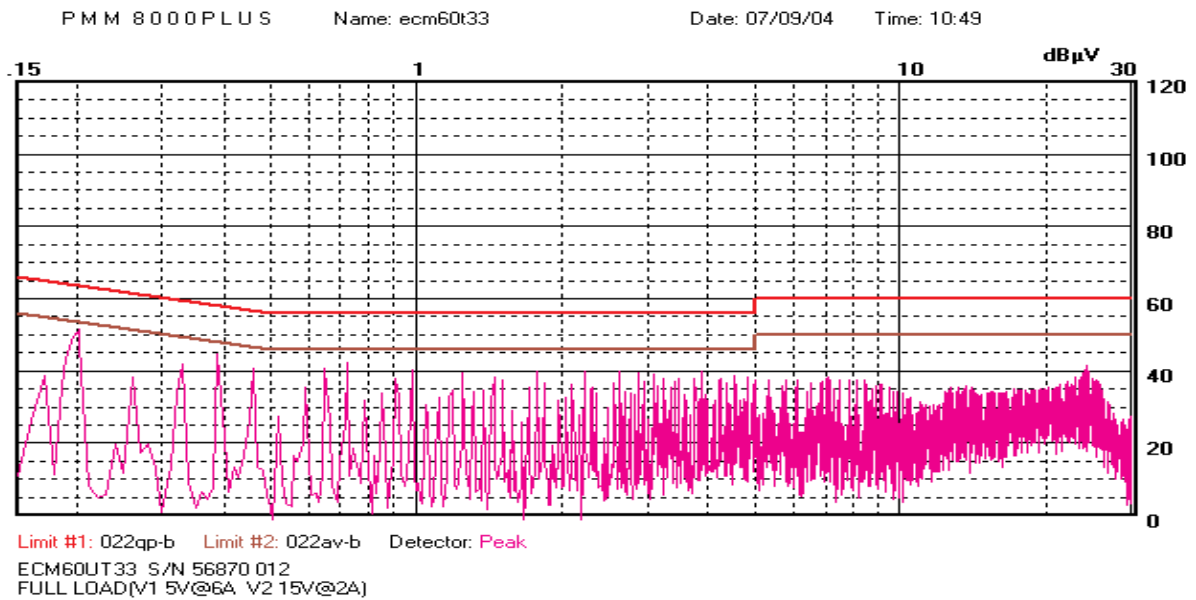

ECM60UT33 at full load

Mechanical Details - Single Output Models

Weight: approx. 0.33 lb (150g)

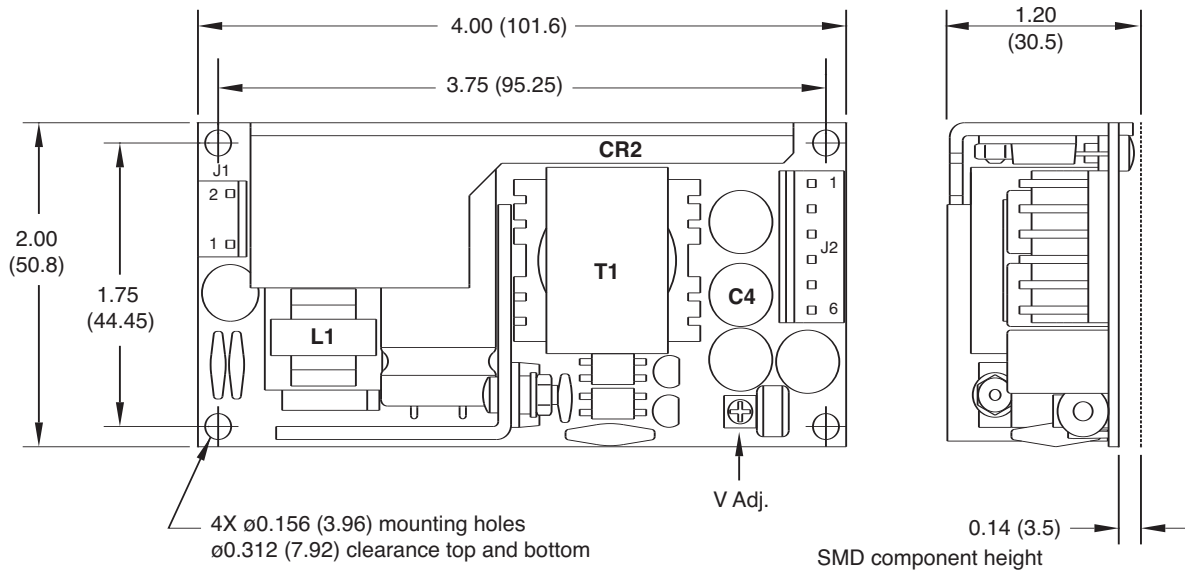

Input Connector J1	
Pin 1	Line
Pin 2	Neutral

J1 mates with Molex housing 43061-0003 and Molex series 5194 crimp terminals. Optional ground (0.25 faston) tab available.

Output Connector J2	
Pin	Single
1	+V1
2	+V1
3	RTN
4	RTN
5	N.C.
6	N.C.

J2 mates with Molex housing 43061-0006 & Molex series 5194 crimp terminals.

Notes

- All dimensions in inches (mm). Tolerance .xx = ±0.02 (0.50); .xxx = ±0.01 (0.25)
- Cable harnesses with 300mm wire available.
For single output models, order part number ECM40/60S LOOM.
For multi-output models, order part number ECM40/60DT LOOM .
- Mating connector kit available. Order part number ECM40/60 CONKIT.
- Covers available. Order part number ECM40/60 COVER. Cover dimensions are 4.49 x 2.52 x 1.52 (114 x 64 x 38.5)
- † All accessories available from Farnell InOne.

Thermal Considerations

To ensure correct and reliable operation of the PSU, the temperature of the components listed in the table below must not be exceeded. See mechanical details for component locations.

Component	Maximum Temperature
L1	110 °C
T1	110 °C
CR2	120 °C
C4	95 °C

Mechanical Details - Single Output Models (3 x 5)

Weight: approx. 0.4 lb (180 g)

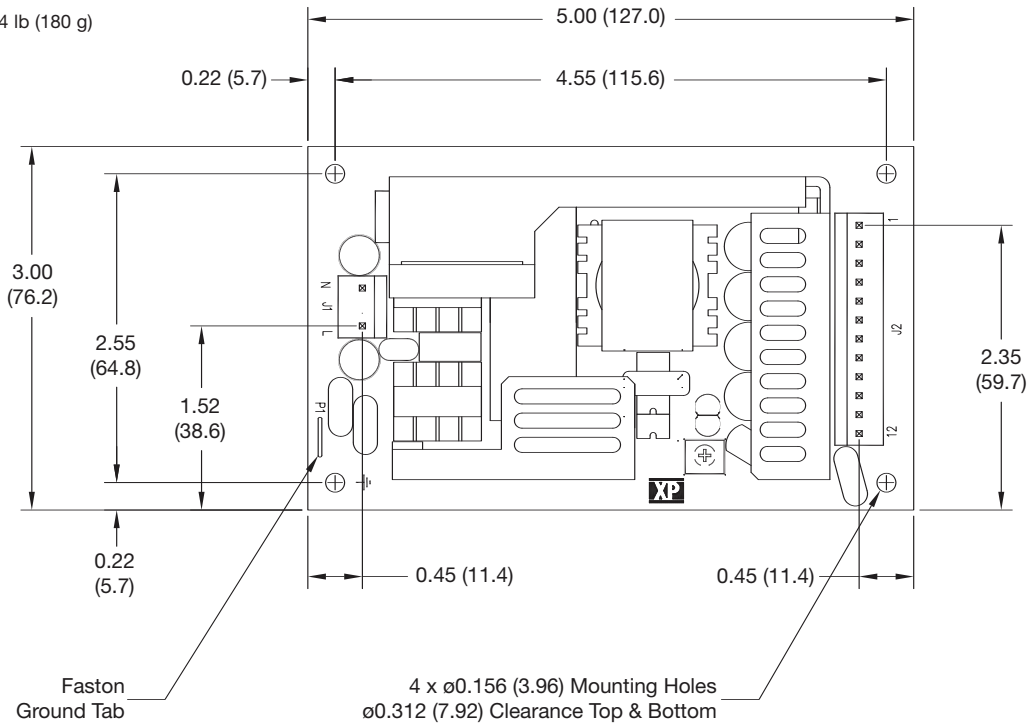

Input Connector J1	
Pin 1	Line
Pin 2	Neutral

J1 mates with Molex housing 43061-0003 and Molex series 5194 crimp terminals. Optional ground (0.25 faston) tab available.

Output Connector J2	
Pin	Single
1	+V1
2	+V1
3	RTN
4	RTN
5	N.C.
6	N.C.

J2 mates with Molex housing 43061-0006 & Molex series 5194 crimp terminals.

Notes

- All dimensions in inches (mm). Tolerance .xx = ± 0.02 (0.50); .xxx = ± 0.01 (0.25)
- Cable harnesses with 300mm wire available.
For single output models, order part number ECM40/60S LOOM.
For multi-output models, order part number ECM40/60DT LOOM.
- Mating connector kit available. Order part number ECM40/60 CONKIT.
- Covers available. Order part number ECM40/60 COVER. Cover dimensions are 4.49 x 2.52 x 1.52 (114 x 64 x 38.5)
- † All accessories available from Farnell InOne.

Thermal Considerations

To ensure correct and reliable operation of the PSU, the temperature of the components listed in the table below must not be exceeded. See mechanical details for component locations.

Component	Maximum Temperature
L1	110 °C
T1	110 °C
CR2	120 °C
C4	95 °C

Mechanical Details - Multi Output Models

Weight: approx. 0.33 lb (150g)

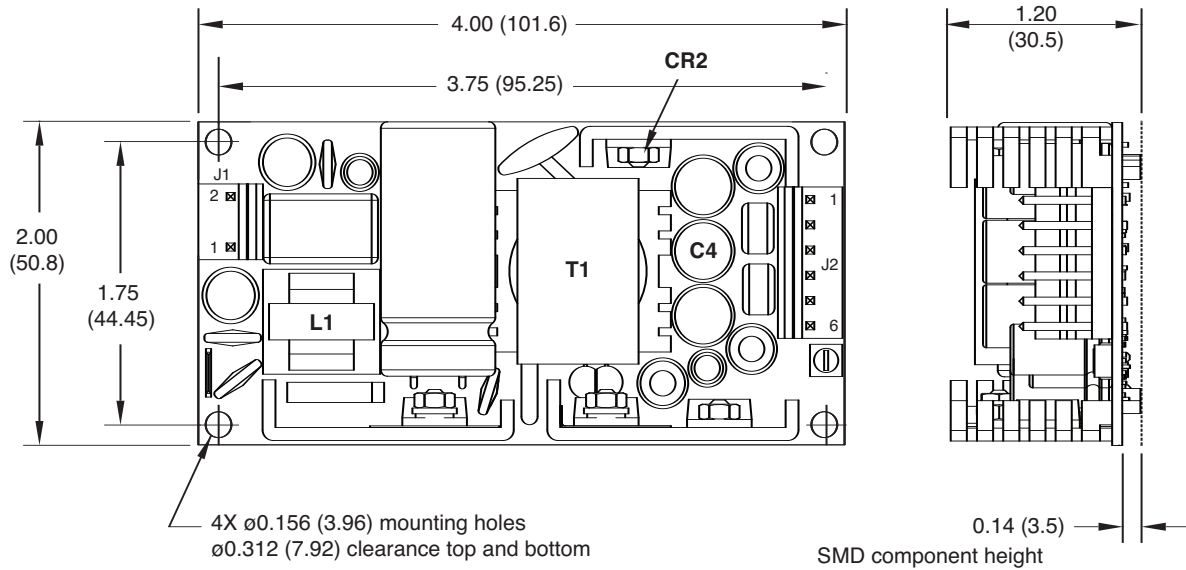

Input Connector J1	
Pin 1	Line
Pin 2	Neutral

J1 mates with Molex housing 43061-0003 and Molex series 5194 crimp terminals. Optional ground (0.25 faston) tab available.

Output Connector J2	
Pin	Single
1	+V1
2	+V1
3	RTN
4	RTN
5	-V3
6	+V2

J2 mates with Molex housing 43061-0006 & Molex series 5194 crimp terminals.

Notes

- All dimensions in inches (mm). Tolerance .xx = ±0.02 (0.50); .xxx = ±0.01 (0.25)
- Cable harnesses with 300mm wire available.
For single output models, order part number ECM40/60S LOOM.
For multi-output models, order part number ECM40/60DT LOOM.
- Mating connector kit available. Order part number ECM40/60 CONKIT.
- Covers available. Order part number ECM40/60 COVER. Cover dimensions are 4.49 x 2.52 x 1.52 (114 x 64 x 38.5)
- † All accessories available from Farnell InOne.

Thermal Considerations

To ensure correct and reliable operation of the PSU, the temperature of the components listed in the table below must not be exceeded. See mechanical details for component locations.

Component	Maximum Temperature
L1	110 °C
T1	110 °C
CR2	120 °C
C4	95 °C

www.xppower.com

North American Sales Offices

Toll Free +1 (800) 253-0490
Central Region +1 (972) 578-1530

Eastern Region +1 (973) 658-8001
Western Region +1 (408) 732-7777

European Sales Offices

Belgium +33 (0)1 45 12 31 15
Denmark +45 43 42 38 33
France +33 (0)1 45 12 31 15
Germany +49 (0)421 63 93 3 0
Italy +39 039 2876027

Netherlands +49 (0)421 63 93 3 0
Norway +47 63 94 60 18
Sweden +46 (0)8 555 367 00
Switzerland +41 (0)56 448 90 80
United Kingdom +44 (0)118 984 5515

Distributors

Australia +61 2 9809 5022 Amtex
Austria +43 (0)2282 3144 Vitcom
Czech Rep. . . +420 235 366 129 Vums Powerprag
Czech Rep. . . +420 377 824 986 Vienna Trading
Finland . . . +358 (0)9 2906 1990 Cool Power
Israel +97 2 9 749 8777 Appletec

Japan +81 48 864 7733 Bellnix
Korea +82 31 421 1404 Bellkor
Portugal +34 93 263 33 54 Venco
Russia +7 (495)234 0636 Prosoft
South Africa . . +27 11 453 1910 Vepac
Spain +34 93 263 33 54 Venco

Global Catalogue Distributors

AmericasNewark www.newark.com
Europe & Asia Farnell www.farnell.com

North American HQ

XP Power
990 Benecia Avenue
Sunnyvale, CA 94085
Phone: +1 (408) 732-7777
Fax : +1 (408) 732-2002
Email : nasales@xppower.com

European HQ

XP Power
Horseshoe Park
Pangbourne
Berkshire, RG8 7JW
Phone: +44 (0)118 984 5515
Fax : +44 (0)118 984 3423
Email : eusales@xppower.com

Asian HQ

XP Power
401 Commonwealth Drive
Haw Par Technocentre
Singapore 149598
Phone: +65 6411 6900
Fax : +65 6741 8730
Email : apsales@xppower.com



T H E X P E R T S I N P O W E R