



LG

Life's Good

使用說明書

液晶體電視

使用電視機之前，請仔細閱讀本手冊，并且妥善保管以供日後查閱。

32LS5600
37LS5600
42LS5600
47LS5600



P/NO : MFL63720141(1203-REV01)
Printed in china

<http://www.lg.com>

目錄

1	目錄	
2	授權	
2	開放源碼注意	
3	安全指引	
9	安裝順序/組裝和準備	
9	安裝順序	
9	組裝和準備	
9	附件	
10	另購產品	
11	零件和按鍵	
12	抬起和移動電視機	
13	裝配電視機	
14	臺式安裝	
15	壁式安裝	
16	整理纜線	
17	建立連接	
17	天綫連接	
18	HDMI連接	
18	DVI與HDMI連接	
19	色差連接	
19	復合連接	
20	RGB-PC連接	
20	USB連接	
20	數字音頻連接	
20	音頻連接	
21	遙控器	
22	使用指南	
23	維護/疑難排解	
23	清潔電視機	
23	- 螢幕, 邊框, 前框和底座	
23	- 電源綫	
23	疑難排解	
24	規格	

授權

支援的授權因型號的不同而有所分別。如欲獲取更多關於授權的資訊，請瀏覽www.lg.com。



在杜比系統實驗室授權下制造。“Dolby”和雙D標識是 Dolby Laboratories的商標。



HDMI，HDMI商標和高清多媒體界面是 HDMI Licensing LLC的商標或註冊商標。



DIVX 視頻簡介：DivX® 是由 DivX, LLC 建立的數碼視頻格式。這是一部播放 DivX 視頻的 DivX Certified® 設備。請瀏覽 www.divx.com 獲取更多資訊，以及獲得將您的檔案轉化成 DivX 視頻的軟件工具。

關於 DIVX 視頻點播：DivX Certified® 設備必須進行註冊，這樣才能播放所訂購的 DivX 視頻點播 (VOD) 電影。如欲獲取您的註冊碼，在您的設備安裝選單中查找 DivX VOD。請瀏覽 vod.divx.com 獲取更多關於如何完成註冊的資訊。

“播放包括付費內容的、高達 1080p 高清的 DivX® 視頻的 DivX Certified® 。

“DivX®, DivX Certified® 和相關標識是 DivX, Inc. 的商標，並且經授權後方可使用。”

“受以下國家專利保護：
7,295,673; 7,460,668; 7,515,710; 7,519,274”

開放源碼注意

欲獲取 GPL、LGPL、MPL 和其他開放源碼許可證下的源代碼（載于本產品之中），請瀏覽：<http://opensource.lge.com>。

除源代碼外，還可下載所有的許可證條款、免責聲明和版權聲明。

安全指引



使用本產品前請仔細閱讀安全防範措施。

警告

- 如無視警告訊息，可能造成重傷或出現事故或死亡。

注意

- 如無視提示訊息，可能造成輕傷或使產品遭受損壞。

注

- 使用前，請仔細閱讀備注資訊中的正確用法。

警告



- 切勿將電視機和遙控器置于以下環境中：
 - 陽光直射的地方。
 - 濕度較大的地方，如浴室。
 - 靠近任何熱源，如爐竈以及其他釋放熱量的設備。
 - 靠近廚房臺面或易于接觸蒸汽或油的加濕器。
 - 暴露于風雨中的地方。
 - 靠近盛水的容器，如花瓶。

否則，這將導致火災、電擊、產品故障或變形。



- 切勿將產品放置會接觸粉塵的地方。
這有引起火災的危險。

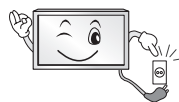

- 電源插頭為切斷裝置，插頭必須始終保持可用狀態。



- 手濕時切勿觸摸電源插頭。另外如果插頭潮濕或覆蓋灰塵，則將插頭徹底擦幹或擦掉灰塵。
濕度過大可能發生觸電危險。



- 確保電源綫連接至接地綫。(除非設備沒有接地綫。)
否則，您可能會觸電或受到人身傷害。

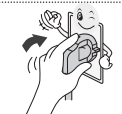

- 將電源綫完全固定。
如果電源綫沒有完全固定，可能造成火災。



- 確保電源綫遠離發熱物體，如加熱器。
否則可能造成火災或者觸電危險。



- 切勿將較重物體或產品放置于電源綫上。
否則可能導致火災或發生觸電危險。



- 將建築物內外之間的天綫電視弄彎，防止雨水進入。
否則雨水進入產品，可能造成產品內部損壞和電擊。



- 將電視機安裝至牆面時，切勿將電視機電源綫和信號綫挂在電視機背面。
否則可能造成火災或者發生觸電危險。

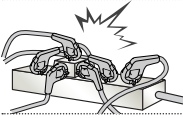

- 切勿將太多電器設備插在同一個多插孔電源插座。
否則可能會由于過熱發生火災事故。



- 連接外部設備時，切勿使產品跌落。
否則可能造成人身傷害或損壞產品。



- 將抗潮濕材料或包裝材料置于兒童無法觸及的地方。
吞食抗潮濕材料，會對身體造成傷害。如不慎吞食，應強迫吞食者將其吐出來并就近就醫。另外，塑料包裝材料會造成窒息。
應將材料置于兒童無法觸及的地方。



- 切勿將兒童攀爬到電視機上或抱住電視機。
否則電視機可能翻倒，從而造成嚴重傷害。



- 將使用過的電池進行仔細處理。防止兒童不慎食用。
如不慎食用，請立即就醫。



- 電源綫一端連接至牆上的輸入接綫柱時，切勿將導體（如金屬塊）插至另一端。另外，將電源綫與牆上的輸入接綫柱接通後，切勿觸摸電源綫，否則可造成觸電危險。



- 切勿將易燃物儲存在產品附近。
否則可能由于易燃物處理不當，發生爆炸或火災。



- 切勿將金屬物體，如硬幣、發夾、筷子、或電源綫投入產品中。兒童應尤其注意。
負責可能發生觸電、火災或者人身傷害。
如異物掉到產品中，拔開電源綫并聯系服務中心。



- 切勿向產品潑水或用易燃物（稀釋劑或苯）擦洗產品。
否則可能發生火災或觸電事故。



- 切勿使產品遭衝擊震動或讓任何物體掉到產品中或使任何物體掉到螢幕上。否則會造成人身傷害或使產品造成損失。



- 切勿在打雷或閃電暴風期間觸摸本產品或天線。否則可能造成觸電。

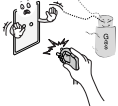

- 出現煤氣泄漏時切勿觸摸壁裝電源插座，同時打開窗戶通風。否則可能造成火災或被火花燒傷。



- 切勿私自拆卸、維修或修改產品。否則可能造成火災或觸電事故。聯絡服務中心對產品進行檢查、校準或修復。



- 如出現以下任一情況，請立即斷開產品電源綫并立即聯絡當地服務中心。
 - 產品受到衝擊影響。
 - 產品受到損壞。
 - 產品進入異物。
 - 產品冒烟或出現火災。
 否則，可能造成火災或電擊。



- 如果長期不使用產品，將產品電源綫斷開。覆蓋灰塵可能造成火災或者絕緣老化可能造成漏電、觸電或火災。

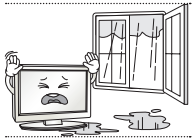

- 電視機不能暴露于油滴或噴霧中，不要將裝有液體的物體（如：花瓶）放在設備上。

注意

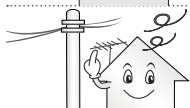

- 將產品安裝在沒有無線電波的地方。



- 室外天綫與電源綫之間應有充分間距，以防天綫落下時室外天綫于電源綫接觸。如兩者接觸，則會導致觸電。

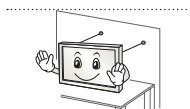

- 禁止將產品安裝在不固定的擱架或傾斜面上，并且避免將產品安在裝在震動或不能完全支撐產品的地方。否則，產品會跌落，造成損傷。



- 如果您打算將產品安裝在置物臺上，則需採取措施避免產品翻轉。否則，產品會跌落，造成損傷。

- 如果將產品安裝在牆內，則需在產品背面貼上標準 VESA 安裝介紹(可選部分)。如果採用掛架支架(可選部分)，則需要仔細安裝，避免產品掉落。

- 祇可采用制造商制定的附屬裝置 / 配件。

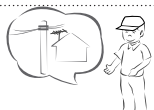

- 安裝天綫時，應該諮詢合格技術人員。這可能造成火災或電腦隱患。

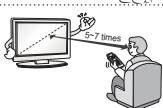

- 我們建議您在看電視時，至少保持距電視機熒幕 5 到 7 倍熒幕對角綫的長度。如果長時間看電視會引起視覺模糊。

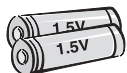

- 祇可采用指定電池。否則，則易損壞遙控器。

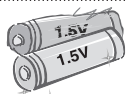

- 禁止新舊電池混合使用。否則會導致電池過熱或電池液體泄漏。



- 確保遙控器和其他測感器之間沒有異物。



- 遙控器信號可能會受到太陽光或其他強光的影響。所以，請調暗屋內光綫。

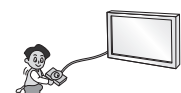

- 當連接外部設備如電子遊戲控制臺時，確保連接綫足夠長。否則，產品易翻倒，容易致造成損傷或損壞。



- 禁止透過從壁裝電源插座上拔插產品電源插頭的方式開關產品。（禁止將電源插頭用作開關。）
這樣做可能會導致機械事故或觸電。

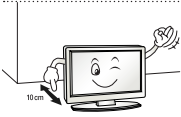

- 請遵照以下安裝指南，以免產品過熱。
 - 牆面和產品之間的距離至少為 10cm。
 - 禁止將產品安裝在不通風的地方。（如書架或櫥櫃）。
 - 禁止將產品安裝在地毯或墊子上。
 - 確保通風口沒有被桌布或窗簾遮擋。
 否則，將會引起火災。

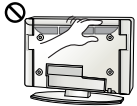

- 注意不要觸摸通風口，因為電視開太久，通風口可能會變得比較熱，但這并不會影響產品的運行或性能。

- 定期檢查電氣軟綫，如發現其外表已損壞或老化，應拔掉該軟綫，停止使用該電氣，并由合格人員替換該軟綫。



- 避免灰塵聚集在電源插頭的插銷或插孔上。
否則會發生火災隱患。

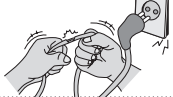

- 確保電源綫外觀不受損壞且不受機械性損傷，如彎曲、扭結、擠壓、門壓或踩踏。
特別需注意插頭、壁裝電源插座以及電器出綫處。



- 禁止用手或其他鋒利的物體（如指甲、鉛筆或鋼筆）用力按在面板上，禁止在面板上留下任何刮痕。



- 避免觸摸熒屏或將手指長時間對着熒幕。這樣可能會對熒幕造成一些臨時的失真效應。



- 當清洗產品及其部件時，首先拔掉電源，然後用一張軟布進行擦洗。不得使用玻璃清潔液、汽車或工業發光體、研磨材料或蠟、苯、酒精等。這些均可能損壞產品及其面板。
否則，也可能引起火災、觸電、或產品損壞（變形、腐蝕或破損）。

- 祇要該裝置連接上 AC 壁裝電源插座，即使您透過開關關掉該裝置，也無法從 AC 電源處斷開。



- 當拔掉電纜時，需抓住插頭，然後再拔掉。
如電源綫內部的綫斷開，則易引起火災。



- 在移動產品時，確保翻轉電纜、天綫電纜以及所有連接電纜。
否則，可能會損壞這些電纜，引發火災或觸電。



- 在移動或拆卸產品時，因產品過重，所以需兩人一組進行移動或拆卸。否則會造成損失。



- 聯絡服務中心（每年一次）對產品的內部件進行清洗。累積的灰塵可能會引起機械故障。



- 當儀器受損時，如當電源綫或插頭受損，液體溢出或有雜質掉入儀器、儀器遭雨水衝洗或受潮，且不能正常運作或已經脫落時，需安排人員進行維修。



- 如果產品摸起來感覺很冷，當打開時有一絲絲的「閃爍」，屬於正常現象，實際上產品本身沒有問題。



- 面板屬於高科技薄膜電晶體產品，具備 200 萬到 600 萬像素的清晰度。您可能會看到微小的黑點和 / 或彩色點（紅、藍或綠色）（表示出現故障），但這不會影響產品的性能和可靠性。該現象同樣還出現在第三方產品上，所以不予更換或退款。



- 面板取決於您收看的位置（上 / 下 / 左 / 右），由於觀看角度的不同，您可能會發現 LCD 屏上會出現不同的亮度和色度。因面板所具有的特性，所以才會出現此類現象。這跟產品的性能沒有關係，也不屬於什麼故障。

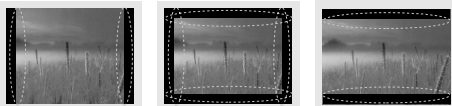

- 長時間顯示靜態影像（如廣播頻道標志、熒幕功能表、視屏游戲場面）可能損壞熒幕，留下影像痕迹，也就是所謂的影像殘留。產品的保修範圍不包括有影像殘留的產品。觀看靜態影像的時間不得超過 1 小時。

還有，如果您長時間觀看比率為 4:3 的電視，影像殘留現象可能會出現在面板的周邊。

這一現象同樣出現在第三方產品，所以不予更換或退款。

• 生成的聲音

「噼噼啪啪」噪音：因溫度和濕度等原因，收看或關掉電視時出現的噼啪聲是因塑料熱收縮產生的。需進行熱變形的產品出現此類聲音屬於正常情況。電路來自一條高速開關電路，該電路供應大量產品操作用的電流。該電路因產品的不同而有所不同。

生成的聲音不會影響產品的性能和可靠性。

! 注

- 顯示的圖像可能與電視不同。
- 電視的 OSD（螢幕顯示）可能與本手冊的 OSD 有所不同。
- 可用功能表和選項也可能不同於您目前正使用的輸入源或產品型號。
- 在不久的將來，此系列的電視中可能還會融入新的產品功能。
- 爲了減少電源損耗，電視可以以待機模式放置。並且在沒有人觀看的情況下，您可以關閉電視，這樣可以減少能源損耗。
- 若降低屏幕亮度，則可以明顯的減少電視機功耗，並且可以減少總能耗。

安裝順序

- 1 打開包裝箱，確認包含所有附件。
- 2 將底座安裝到電視機上。
- 3 連接外部設備到電視機上。
- 4 確認網絡連接是可用的。
祇有在建立網絡連接後，你才能使用電視機的網絡功能。

組裝和準備

附件

檢查您的包裝箱內是否有以下物品。
如果缺少附件，請聯絡您購買產品的當地經銷商。
本手冊中的圖例可能會與實際產品和物品有差異。

! 注意

- 請勿使用未經核準的物品，以確保安全和產品使用壽命。
- 因使用未經批准的物品而造成的任何損壞或傷害，都不在保修範圍之內。

! 注



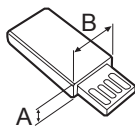
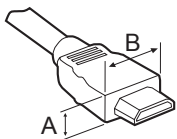



- 與產品隨附的一些物品，可能會因型號的不同而有所分別。
- 如產品功能升級，可能會在未事先通知的情況下，對產品或本手冊中的內容進行更改。
- 如想達到最佳連接效果，HDMI 纜綫和 USB 設備厚度不超過 10 mm，寬度不超過 18 mm。
如果是 USB 綫和 USB 記憶體則使用支援 USB2.0 的延伸電纜。

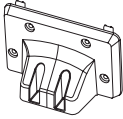
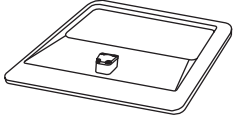
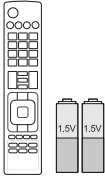

*A ≤ 10 mm

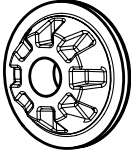
*B ≤ 18 mm

下圖所示僅為示意圖，請以實物為準。

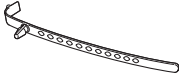
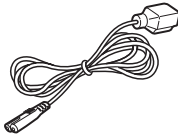
		
機身	底座支架	底座
		 X4 個
遙控器和電池 (AAA)	用戶手冊	壁掛內隔圈
	 X8 個 M4 X 20	
清潔布 使用此清潔布清除前框上的灰塵。	底座安裝螺絲	底座固定螺釘
		
纜綫固定夾	電源綫	

另購產品

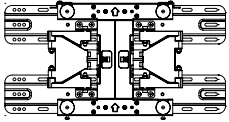
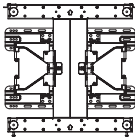
	
壁掛支架 LSW200BX, LSW200BXG 詳情請見第 15 頁	壁掛支架 LSW400BX, LSW400BXG 詳情請見第 15 頁

零件和按鍵



注意

- 請勿使用未經核準的物品，以確保安全和產品使用壽命。
- 因使用未經批准的物品而造成的任何損壞或傷害，都不在保養範圍之內。
- 一些型號上的螢幕上貼有薄膜，請勿將其撕除。

下圖所示僅為示意圖，請以實物為準。

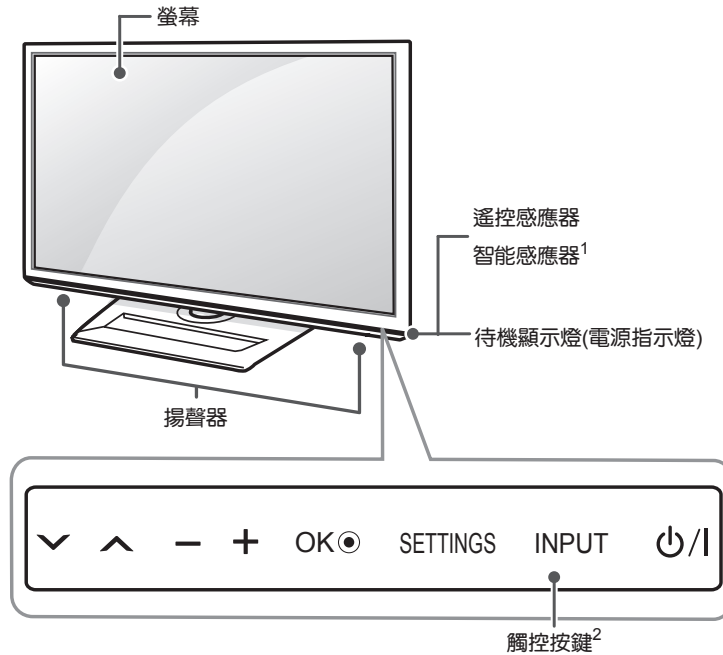

觸控按鍵	說明
∨ ^	頻道選擇。
- +	調整音量大小。
OK ●	確定所選操作。
SETTINGS	進入主選單，保存您的輸入源或退出選單。
INPUT	改變輸入源。
⏻ / I	開啓或關閉電源。

- 1 智能感應器 - 根據周圍環境調節背光度。
- 2 所有按鍵都是觸碰感應的，可以祇用手指觸碰來操作。



注

- 通過選擇主選單中的“其他選項”，您可以設置待機顯示燈開啓或關閉。

抬起和移動電視機

在抬起和移動電視機時，請閱讀下列事項，以免造成電視機刮傷或損壞，並按其型號大小進行安全運輸。



注意

- 任何時候都要避免碰觸螢幕，否則可能會損壞螢幕。
- 我們建議將電視機放進原本的包裝箱或者包裝材料中再做移動。
- 在抬起和移動電視機之前，應拔掉電源線和所有電纜。
- 在抓握電視機時，螢幕應背對着您以免損壞。

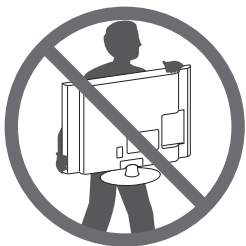

- 牢牢抓住電視機框的頂部和底部。
- 切勿抓住透明部位、揚聲器或者揚聲器底部區域。

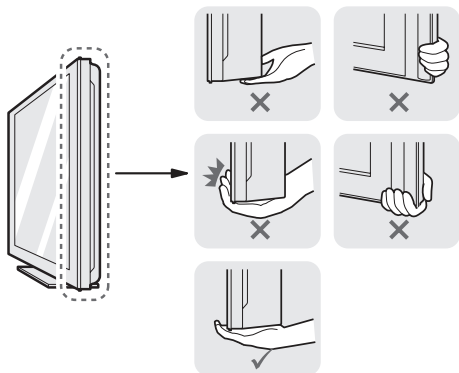

- 至少由 2 人來搬運一部大電視機。
- 用手搬運電視機時，按照下圖所示搬運電視機。

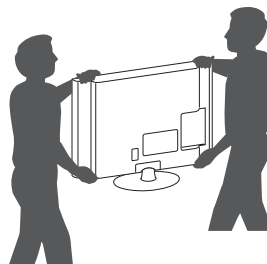

- 在搬運電視機時，請勿使電視機劇烈搖晃或過分震動。
- 在搬運電視機時，使電視機保持豎直。請勿翻轉電視機，或將其向左向右傾斜。



裝配電視機

下圖所示僅為示意圖，以實物為準。

1

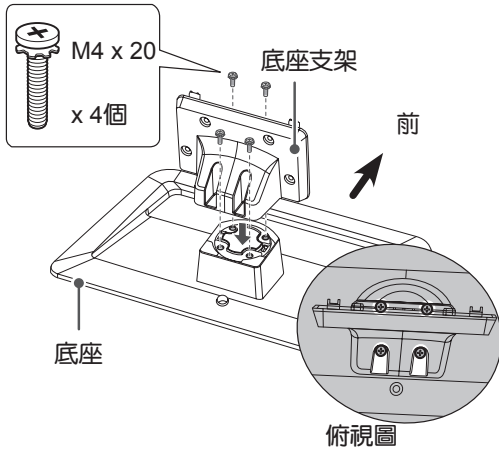

2

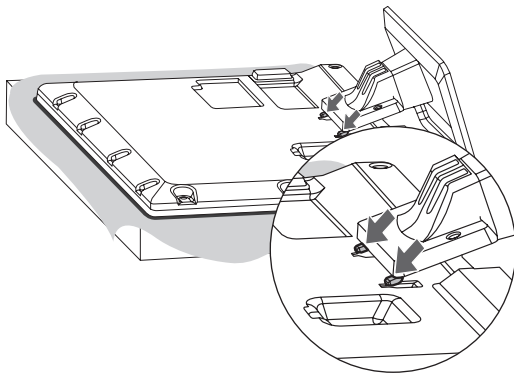

3

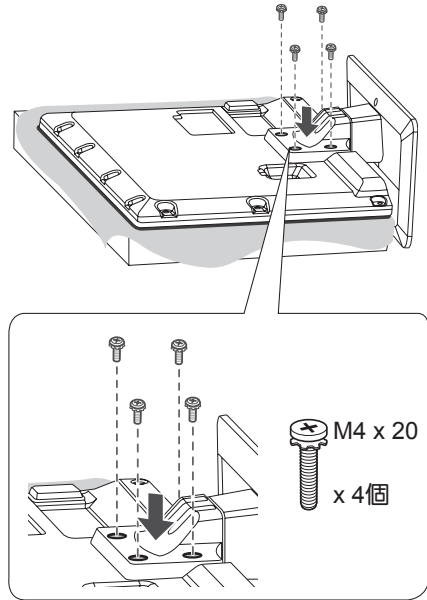

⚠ 注意

- 將底座安裝到電視機時，請放置在一塊泡沫墊或者柔軟保護布上，以免螢幕損壞。確保沒有物體壓在螢幕上。
- 扭緊螺絲以免電視機向前傾斜，但不能過度扭緊。

! 注

在電視機安裝到牆壁之前將底座按照相反順序從電視上卸除。

臺式安裝

- 1 抬起并將電視機傾斜至直立位置，放在桌子上。
- 與牆壁間保留出 10 cm (最小) 空間，用于適當通風。

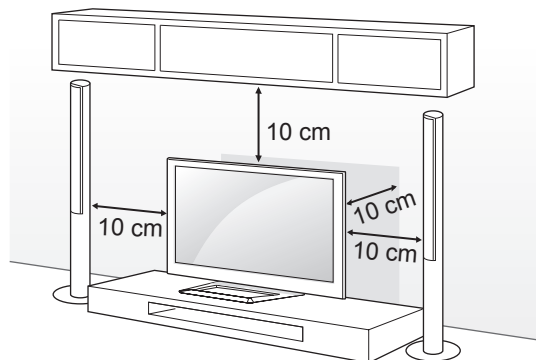

- 2 將電源綫連接至壁裝電源插座。

⚠ 注意

- 請勿將電視機靠近或放置於熱源之上，否則可引致火災或者發生損壞。

將電視機固定到桌子上

將電視機固定在桌子上，以免前傾、損壞和潛在傷害。

將電視機安裝在桌子上，并在底座背部插入和扭緊隨附的螺釘。

以下僅為示意圖可能與實物不符，以實物為準。

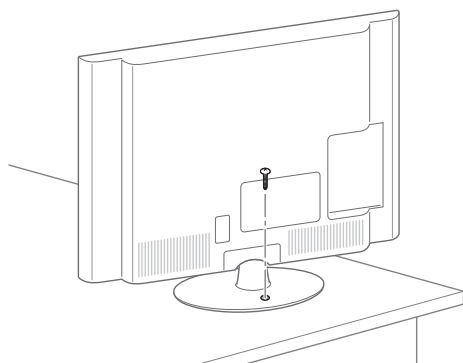

調整電視角度

您可以在 20 ± 2 度範圍內左右手動旋轉底座以達到最佳觀看視角。

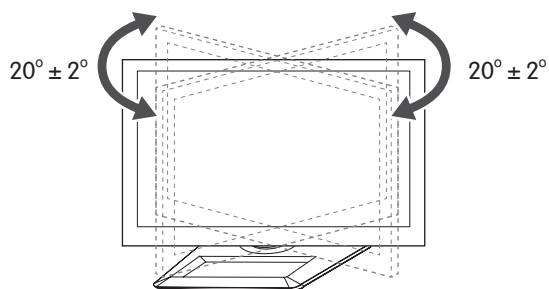

⚠ 注意

- 當您調整產品角度時，注意您的手指被損傷。
- 如果手或手指被擠壓，可能造成人身傷害。如果產品傾斜太多，它可能會跌落，這可能會引起財產損失或人身傷害。

kensington 安保系統

(此功能不是所有型號都適用)

Kensington(肯辛通)安全系統連接在電視機的背面。更多安裝適用信息請參考Kensington(肯辛通)安全系統提供的使用說明書，或者登陸<http://www.kensington.com>。

在電視機和桌子之間連接Kensington(肯辛通)安全系統綫纜。

以下僅為示意圖可能與實物不符，以實物為準。

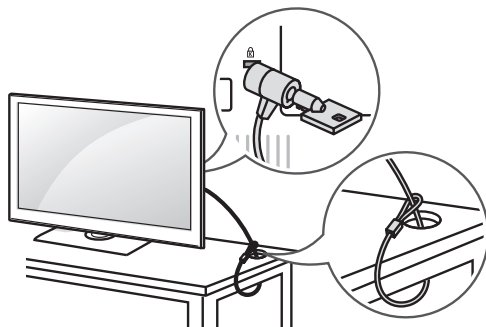

注：Kensington(肯辛通)安全系統是可選附件，您可以從當地供應商那裏獲取其他附件。



將電視機固定至牆壁上

(此功能不是所有型號都適用。)

- 1 在電視機背面插入鉸接螺栓并扭緊。
 - 如果在鉸接螺栓位置已插有螺釘，先將螺釘拆下。
- 2 利用螺釘將掛牆支架安裝至牆壁上。
 - 使掛牆支架和電視機後部鉸接螺栓的位置相配。
- 3 用堅固的繩子緊緊連接鉸接螺栓和掛牆支架。
 - 確保繩子與平面保持水平。

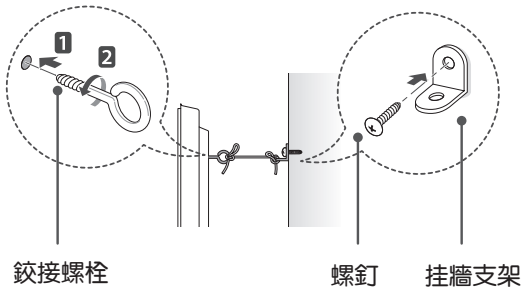
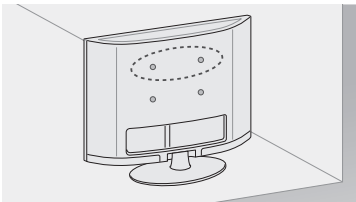

注意

- 確保兒童不會攀爬或懸吊在電視機上。

注

- 使用足夠牢固和足夠大的平臺或電視櫃來牢固支撐電視機。

壁式安裝

小心地將可選壁掛支架安裝在電視機後部，并將壁掛支架安裝在與地面垂直的實體牆上。如打算連接電視機至其他建築材料上，請聯絡合格的操作人員。LG建議由專業安裝人員幫助您安裝壁掛支架。

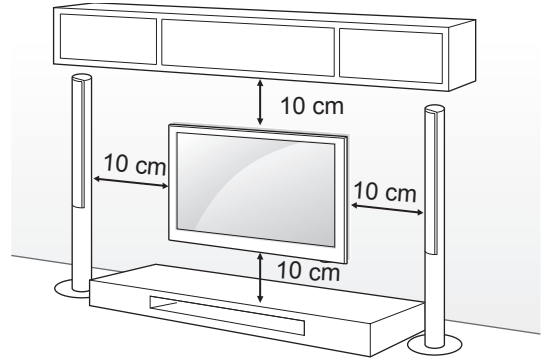

確保使用符合VESA標準的螺絲和壁掛支架。壁掛支架的標準尺寸見下表。

另購產品 (壁掛支架)

型號	32/37LS5600	42/47LS5600
VESA	200 x 200	400 x 400
標準螺絲	M6	M6
螺絲的數量(個)	4	4
壁掛支架	LSW200BX, LSW200BXG	LSW400BX, LSW400BXG

⚠ 注意

- 首先切斷電源，然後再移動或安裝電視機，否則可能會觸電。
- 如果在天花板或歪斜的牆壁上安裝電視機，電視可能會墜落和導致嚴重傷害。應使用經授權的 LG 壁掛支架，並且聯絡本地經銷商或符合資格的操作人員。
- 請勿過度扭緊螺絲，否則會對電視機造成傷害，並且會令保養無效。
- 使用符合 VESA 標準的螺絲和壁掛支架。錯誤使用或使用錯誤附件造成的損傷和傷害，不在保養範圍內。

! 注

- 使用列于 VESA 標準螺絲規範上的螺絲。
- 完整的壁掛支架包含安裝手冊和必要的零件。
- 壁掛支架是可選物品。您可以從當地經銷商處購買附件。
- 螺絲的長度因掛架不同而不同。確保使用正確長度的螺絲。
- 如欲獲取更多資訊，請查閱壁掛支架隨附的手冊。
- 在安裝壁掛支架前，在裝置上放置壁掛內隔圈，將裝置的背面傾斜度可調整至垂直狀態。

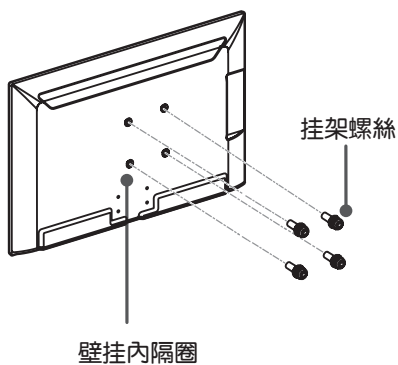

整理纜綫

- 1 用纜綫固定夾集攏和捆綁纜綫。

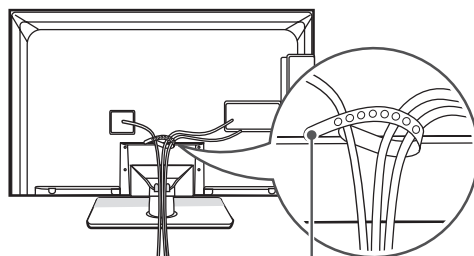

纜綫固定夾

⚠ 注意

- 不要通過握住纜綫固定夾移動電視，因為纜綫可能會斷裂，引起電視的損壞和損害。

建立連接

以下僅為示意圖可能與實物不符。

連接不同的外部設備至電視機，轉換輸入模式以選擇一個外部設備。欲獲取外部設備連接的更多資訊，可以查閱每臺設備隨附的手冊。

可用外部設備是：硬碟接收器，DVD 播放器，錄影機，音頻系統，USB 存儲設備，個人電腦，遊戲設備，和其他外部設備。

！ 注

- 外部連接設備因型號不同而有所分別。
- 不考慮電視接口順序，將外部設備連接至電視機上。
- 若您在一部 DVD 錄影機或錄影機上錄下電視節目，確認將電視機信號輸入線纜經一部 DVD 錄影機或錄影機連接至電視機上。欲獲取更多錄影資訊，查閱所連接設備隨附的手冊。
- 請查閱外部設備手冊獲取使用說明。
- 如果您連接一部遊戲設備至電視上，需使用與遊戲設備隨附的纜線。
- 在個人電腦模式中，調整解像度、垂直模式、對比度或亮度時可能會發出噪聲。如果噪聲持續存在，請改變個人電腦輸出到另一個解像度，將刷新頻率調到另一種刷新頻率或在“圖像”菜單上調整亮度和對比度，直至圖像顯示清楚。
- 在個人電腦模式中，依據顯卡的不同一些分辨率設置可能不能正常工作。
- 在個人電腦模式下，水平頻率和垂直頻率的同步輸入波都是獨立的。

天線連接

使用RF纜線（75Ω）連接電視機到牆壁天線插孔。

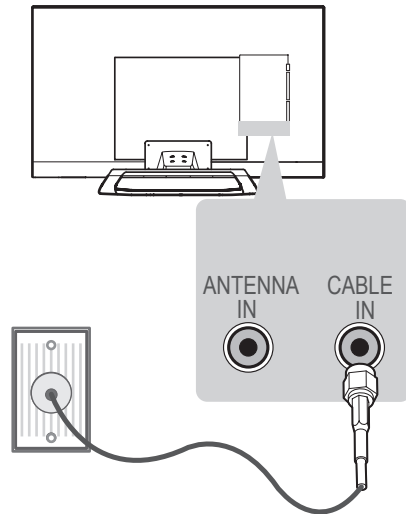

！ 注

- 使用兩臺或兩臺以上 TV 時，請使用信號分離器。
- 如果畫面質量很差，請使用信號放大器來改善畫面質量。
- 如果連接天線後畫面質量很差，請重新調整天線到正確的方向。
- 天線和轉接器本公司不提供。

HDMI 連接

從一部外部設備傳輸數碼視頻和音頻訊號至電視機。按照下圖所示，使用HDMI纜線連接外部設備與電視機。

選擇任意一個HDMI輸入接口進行連接。
您可以使用任何一個輸入接口。

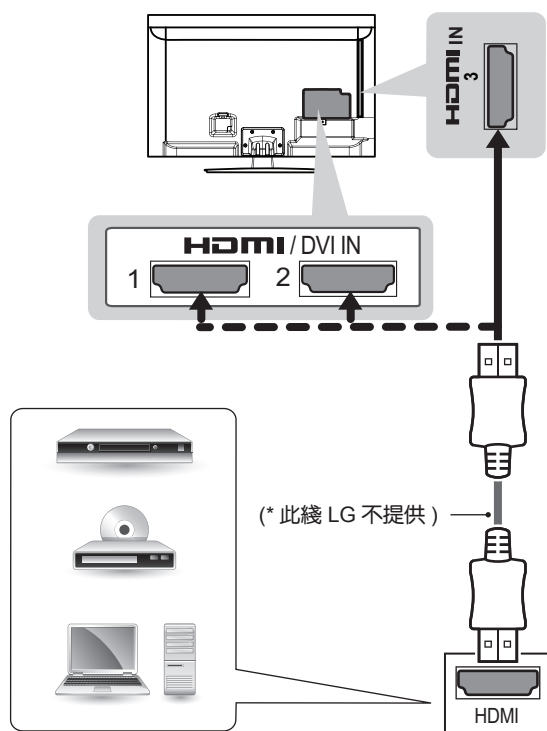

DVD / 藍光光碟 / HD 綫纜盒 / HD 機頂盒 / 個人電腦

! 注

- 為獲取最佳圖像質量，我們建議使用 HDMI 連接。
- 使用帶有 CEC (用戶電子控制裝置) 功能的最新高速 HDMI™ 纜線。
- 測試高速 HDMI™ 纜線能否傳輸 1080p 及以上的 HD 信號。
- 支持的 DTV 音頻：MPEG, Dolby Digital。
- 支持的 HDMI 音頻格式：Dolby Digital, PCM (192 KHz 以上, 32k/44.1k/48k/88k/96k/176k/192k) → 不支持 DTS。

DVI 與HDMI 連接

從一部外部設備傳輸數碼訊號至電視機。按照下圖所示，使用DVI-HDMI 纜線連接外部設備和電視機。欲傳輸音頻訊號，連接一個音頻纜線。

選擇任意一個HDMI輸入接口進行連接。
您可以使用任何一個輸入接口。

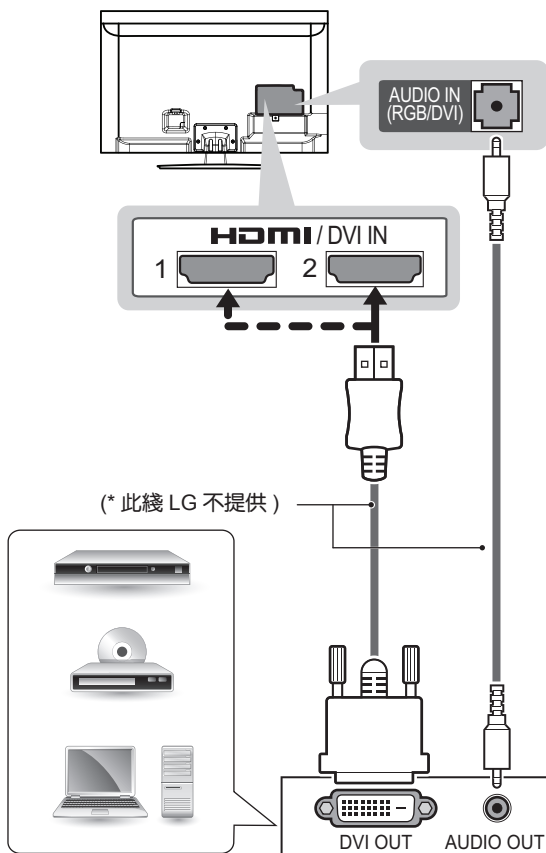

DVD / 藍光光碟 / HD 綫纜盒 / 個人電腦

! 注

- 根據顯卡而定，如果使用 DVI 纜線連接 HDMI，則 DOS 模式可能無法正常運行。

色差連接

從一部外置設備傳輸模擬視頻和音頻訊號至電視機。按照下圖所示，使用色差纜線連接外部設備與電視機。

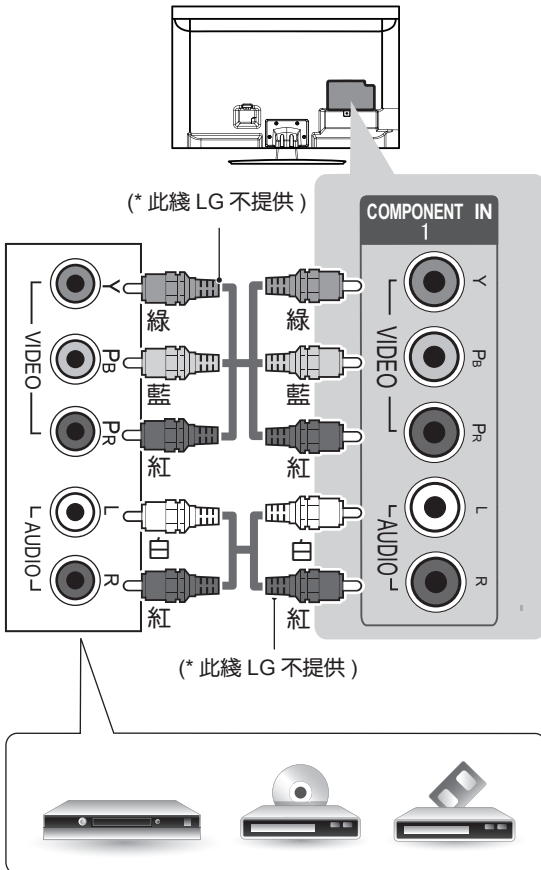

DVD / 藍光光碟 / HD 綫纜盒

! 注

- 如果纜線安裝錯誤，畫面可能顯示為黑白色或者顯示失真顏色。
- 檢查確保纜線匹配正確的顏色。

復合連接

從一部外部設備傳輸模擬視頻和音頻訊號至電視機。按照下圖所示，使用復合纜線連接外部設備與電視機。

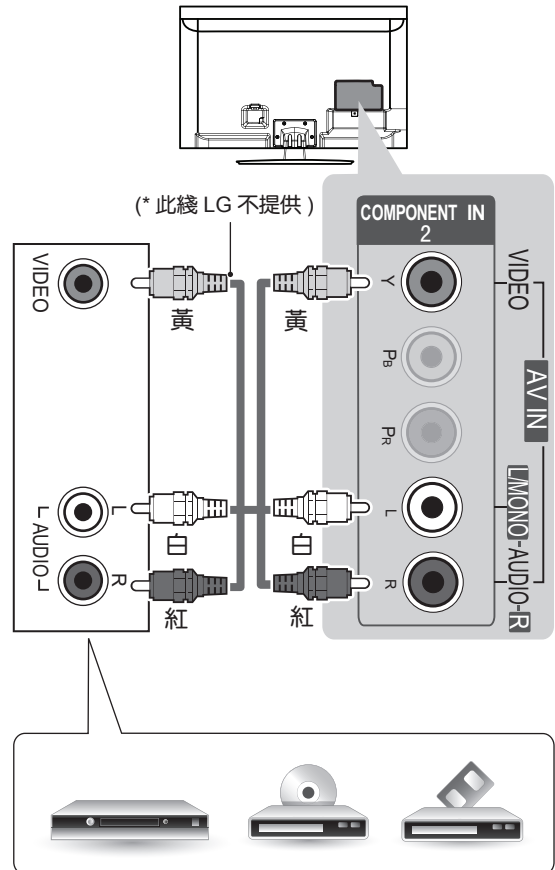

VCR / DVD / 藍光光碟 / HD 綫纜盒

! 注

- 如果纜線安裝錯誤，畫面可能顯示為黑白色或者顯示失真顏色。
- 檢查確保纜線匹配正確的顏色。



RGB-PC 連接

從您的個人電腦傳輸視頻訊號至電視機。欲傳輸音頻訊號，連接一個音頻纜線。

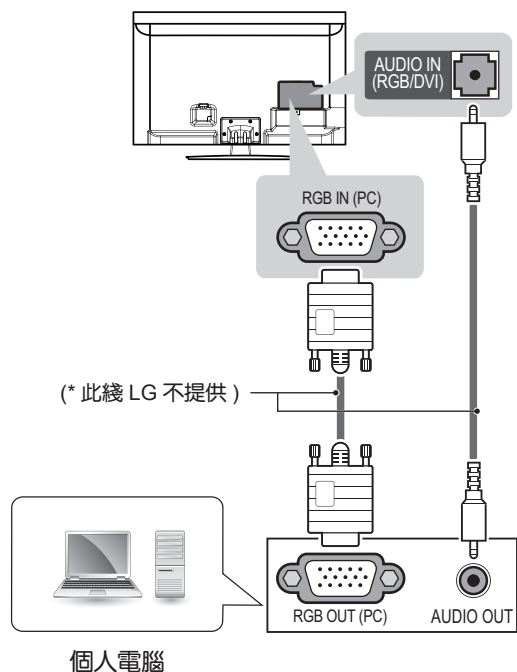

USB 連接

連接一個USB存儲設備，例如USB快閃存儲卡讀卡器至電視機，並進入智能共享選單使用不同的多媒體檔案。

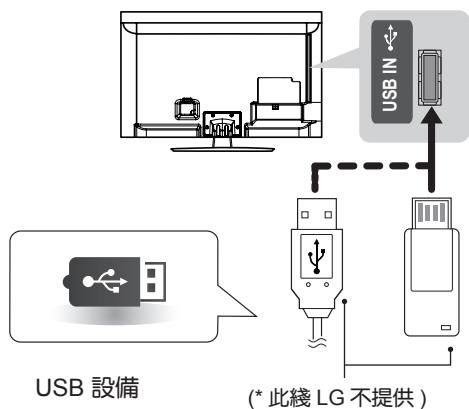

! 注

- 在關機之前請安全移除 USB 存儲設備。

數字音頻連接

從電視機傳輸數碼音頻訊號至一個外部設備。按照下圖所示，使用音頻纜線連接外部設備和電視機。

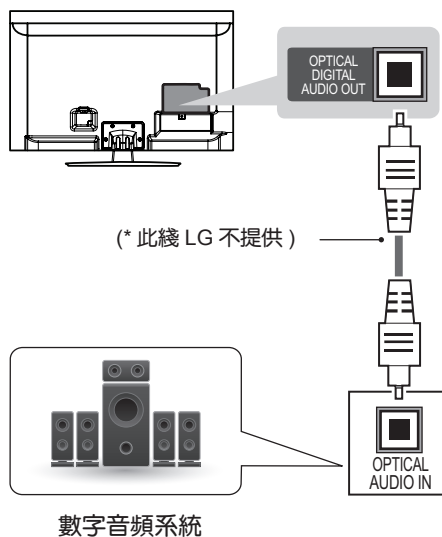

! 注

- 切勿直視數字音頻輸出接口。盯着激光束會損傷您的視力。
- 具有 ACP (音頻復制保護) 功能的音頻可能限制數字音頻的輸出。

音頻連接

您可以使用配置的外部音頻系統替代電視機內置的揚聲器。

! 注

- 如果您使用配置的外部音頻系統替代電視機內置，請將電視機的揚聲器設置為關閉。

遙控器

此說明書中的描述依據遙控器的實際按鍵。

請仔細閱讀此說明書，并正確使用電視。

更換電池步驟：打開遙控後面的電池盒蓋，按照正確的極性方向（⊕對⊕，⊖對⊖）

插入電池（1.5 V AAA），合上後蓋。

欲拆卸電池，請按照相反步驟進行。

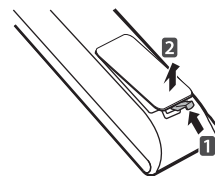

注意

- 請勿將舊電池和新電池混用，否則可導致遙控器損壞。

確保遙控器對準電視機上的遙控感應器。

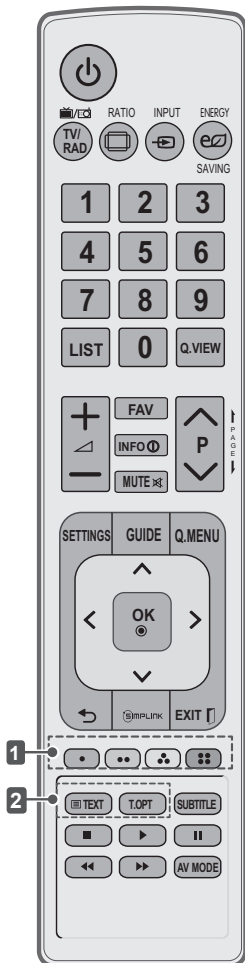

⏻ (電源)	將電視機開啓或待機狀態。
TV / RAD (電視/廣播)	選擇Radio, TV和 DTV頻道。
RATIO(比例)	調整畫面大小。
INPUT(輸入)	改變輸入源，打開電視。
ENERGY SAVING(節能)	調整螢幕亮度以降低能源消耗。
Number button(數字按鍵)	輸入數據。
LIST(清單)	進入所存儲的節目清單。
Q.VIEW(快速收看)	返回上一個收看的節目。
+ -	調整音量大小。
FAV(收藏)	進入您所喜愛的節目清單。
INFO ⓘ (諮詢)	查看目前節目和螢幕信息。
MUTE (靜音)	關閉或打開聲音。
P ^ v	選擇某個節目頻道。
PAGE(翻頁)	跳至上或下一個畫面。
SETTINGS	進入設置選單。
GUIDE(節目指南)	顯示節目指南。
Q.MENU(快速選單)	進入快捷菜單。
Navigation buttons (導航鍵) (上/下/左/右)	選擇菜單或選項。
OK ● (確定)	選擇選單或選項，并且確認您的輸入。
↶ (返回)	返回上一級。
SIMPLINK	訪問連接至電視的AV設備；打開SIMPLINK功能表。
EXIT (退出)	清除全部螢幕顯示，并且返回收看電視。
1 Coloured buttons (有色按鍵)	訪問某些功能表上的特殊功能。 (●:紅, ●:綠, ●:黃, ●:藍)
2 TELETEXT BUTTONS	這些按鍵用于圖文數字。
SUBTITLE(字幕)	數碼模式時選擇想要的字幕。
Control buttons (控制按鍵) (■, ▶, II, ◀, ▶)	控制我的媒體選單或SIMPLINK兼容設備 (USB或SIMPLINK)。
AV MODE (AV模式)	選擇一個AV模式。

使用指南

使用用戶指南，您可以容易地獲取電視的詳細信息。
本手冊中的圖例可能會與實際產品和物品有差異。

- 1 按“SETTINGS”按鍵進入主選單。
- 2 按顏色按鍵的“”紅色按鍵進入“客戶支援”菜單。
- 3 按導航鍵選擇“使用指南”并按“OK ”。



- 1 選擇您需要的種類。
- 2 選擇您需要的項目。
您可以使用 進行翻頁。
- 3 在索引中瀏覽你需要的功能的描述。

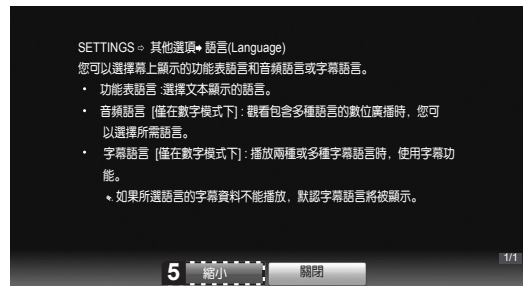
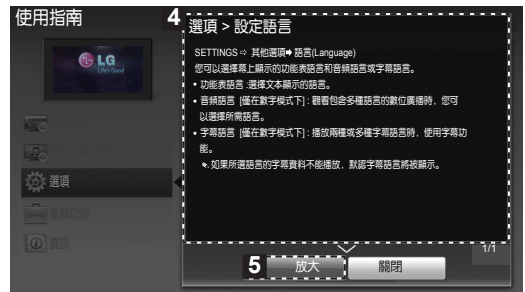

- 4 顯示被選菜單的描述。
您可以使用 進行翻頁。
- 5 放大或縮小畫面。

維護

清潔電視機

定期仔細清潔，可延長電視機的使用壽命。

螢幕，邊框，前框和底座

- 使用乾淨、清潔和柔軟的表面來去除灰塵或污垢。
- 用在清水或稀釋中性洗滌劑中浸濕的軟布表面擦拭污垢，然後立即用幹布擦拭。



注意

- 避免長時間按壓螢幕，因為這樣可能損傷螢幕。
- 請勿用您的手指或鋒利物體來推、摩擦或創擊表面，因為這會造成螢幕上出現刮痕以及圖像失真。
- 請勿使用任何化學劑，因為可能會損傷電視表面。
- 請勿將液體噴射到電視表面。如果水分進入電視機，就可能引發火災、觸電或故障。

電源綫

定期清理電源綫上積聚的灰塵或污垢。

疑難排解

問題	解決方法
不能用遙控器控制電視機。	<ul style="list-style-type: none"> • 檢查遙控器是否對準電視機上的遙控感應器，然後再試。 • 檢查產品和遙控器之間是否有障礙物。 • 檢查電池是否仍然工作並且正確安裝 (+ 對 +, - 對 -)。
沒有圖像顯示和沒有聲音。	<ul style="list-style-type: none"> • 檢查產品是否開機。 • 檢查電源綫是否連接至牆身插座。 • 連接其他產品，以檢查牆身插座是否存在問題。
電視機突然關機。	<ul style="list-style-type: none"> • 檢查電源控制設定。供電可能中斷。 • 檢查時間設定中是否啟動睡眠時間設定功能。 • 若電視機開啓時沒有信號，則在 15 分鐘之後電視機自動關機。
連接電腦 (RGB/HDMI DVI)，顯示‘無訊號’或者‘無效的格式’。	<ul style="list-style-type: none"> • 使用遙控器打開或關閉電視機。 • 重新連接 RGB/HDMI 綫纜。 • 在電視機打開狀態下，重新啓動電腦。

規格

產品規格可能有變更，恕不另行通知。

項目		型號	32LS5600	37LS5600
產品尺寸 (寬×高×深)	連底座		746.0mm x 527.0mm x 204.0mm	856.0mm x 590mm x 204.0mm
	不連底座		746.0mm x 462.0mm x 52.2mm	856.0mm x 524.0mm x 52.2mm
產品質量	連底座		9.7Kg	12.4Kg
	不連底座		8.4Kg	10.5Kg
電源			AC 100-240V~50/60Hz	AC 100-240V~50/60Hz

項目		型號	42LS5600	47LS5600
產品尺寸 (寬×高×深)	連底座		979.0 mm × 660.0 mm × 269.0 mm	1089.0 mm × 720.0 mm × 269.0 mm
	不連底座		979.0 mm × 594.0 mm × 52.2 mm	1089.0 mm × 655.0 mm × 52.2 mm
產品質量	連底座		15.1 Kg	17.8 Kg
	不連底座		12.6Kg	15.3 Kg
電源			AC 100-240V~50/60Hz	AC 100-240V~50/60Hz

項目		型號	32/37/42/47LS5600
環境條件	運作溫度 運作濕度		0° C 至40° C 低於80 %
	儲存溫度 儲存濕度		-20° C 至60° C 低於85 %



記下電視機的型號和序列號。
參考封底的標籤并引用此資訊。
如需任何服務，請聯絡經銷商。

型號 _____

序列號 _____



LG

Life's Good

OWNER'S MANUAL LED LCD TV

Please read this manual carefully before operating your set and retain it for future reference.

32LS5600
37LS5600
42LS5600
47LS5600

TABLE OF CONTENTS

1 TABLE OF CONTENTS

2 LICENSES

2 OPEN SOURCE SOFTWARE NOTICE

3 SAFETY INSTRUCTIONS

9 INSTALLATION PROCEDURE/ ASSEMBLING AND PREPARING

- 9 Installation Procedure
- 9 Unpacking
- 10 Separate purchase
- 11 Parts and buttons
- 12 Lifting and moving the TV
- 13 Setting up the TV
- 14 Mounting on a table
- 15 Mounting on a wall
- 16 Tidying cables

17 MAKING CONNECTIONS

- 17 Antenna connection
- 18 HDMI connection
- 18 DVI to HDMI connection
- 19 Component connection
- 19 Composite connection
- 20 RGB-PC connection
- 20 USB connection
- 20 Digital optical audio connection
- 20 Audio connection

21 REMOTE CONTROL

22 USING THE USER GUIDE

23 MAINTENANCE/TROUBLESHOOTING

- 23 Cleaning your TV
- 23 - Screen, frame, cabinet and stand
- 23 - Power cord

24 SPECIFICATIONS

LICENSES

Supported licenses may differ by model. For more information about licenses, visit www.lg.com.

ENGLISH



Manufactured under license from Dolby Laboratories. “Dolby” and the double-D symbol are trademarks of Dolby Laboratories.



HDMI, the HDMI logo and High-Definition Multimedia Interface are trademarks or registered trademarks of HDMI Licensing LLC.



ABOUT DIVX VIDEO: DivX® is a digital video format created by DivX, LLC, a subsidiary of Rovi Corporation. This is an official DivX Certified® device that plays DivX video. Visit divx.com for more information and software tools to convert your files into DivX video.

ABOUT DIVX VIDEO-ON-DEMAND: This DivX Certified® device must be registered in order to play purchased DivX Video-on-Demand (VOD) movies. To obtain your registration code, locate the DivX VOD section in your device setup menu. Go to vod.divx.com for more information on how to complete your registration.

“DivX Certified® to play DivX® video up to HD 1080p, including premium content.”

“DivX®, DivX Certified® and associated logos are trademarks of Rovi Corporation or its subsidiaries and are used under license.”

“Covered by one or more of the following U.S. patents :
7,295,673; 7,460,668; 7,515,710; 7,519,274”

OPEN SOURCE SOFTWARE NOTICE

To obtain the source code under GPL, LGPL, MPL and other open source licenses, that is contained in this product, please visit <http://opensource.lge.com>.

In addition to the source code, all referred license terms, warranty disclaimers and copyright notices are available for download.

SAFETY INSTRUCTIONS



Please read these safety precautions carefully before using the product.

WARNING

- If you ignore the warning message, you may be seriously injured or there is a possibility of accident or death.

CAUTION

- If you ignore the caution message, you may be slightly injured or the product may be damaged.

NOTE

- The note helps you understand and use the product safely. Please read the note carefully before using the product.

WARNING



- Do not place the TV and remote control in the following environments:
 - A location exposed to direct sunlight
 - An area with high humidity such as a bathroom
 - Near any heat source such as stoves and other devices that produce heat
 - Near kitchen counters or humidifiers where they can easily be exposed to steam or oil
 - An area exposed to rain or wind
 - Near containers of water such as vases

Otherwise, this may result in fire, electric shock, malfunction or product deformation.



- Do not place the product where it might be exposed to dust. This may cause a fire hazard.

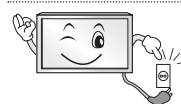

- Mains plug is the disconnecting device. The plug must remain readily operable.



- Do not touch the power plug with wet hands. Additionally, if the cord pin is wet or covered with dust, dry the power plug completely or wipe dust off. You may be electrocuted due to excess moisture.



- Make sure to connect the power cable to the grounded current. (Except for devices which are not grounded.) You may be electrocuted or injured.



- Fix the power cable completely. If the power cable is not fixed completely, a fire can break out.



- Ensure the power cord does not come into contact with hot objects such as a heater. This may cause a fire or an electric shock hazard.



- Do not place a heavy object, or the product itself, on power cables. Otherwise, this may result in fire or electric shock.

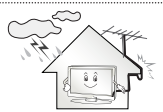

- Bend antenna cable between inside and outside building to prevent rain from flowing in. This may cause water damaged inside the Product and could give an electric shock.

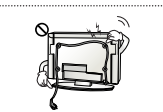

- When mounting a TV it on the wall, make sure not to install TV by hanging power and signal cables on the back of the TV. It may cause fire, electric shock.

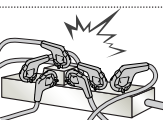

- Do not plug too many electrical devices into a single multiple electrical outlet. Otherwise, this may result in fire due to over-heating.

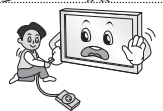

- Do not drop the product or let it fall over when connecting external devices. Otherwise, this may result in injury or damage to the product.



- Keep the packing anti-moisture material or vinyl packing out of the reach of children. Anti-moisture material is harmful if swallowed. If swallowed by mistake, force the patient to vomit and visit the nearest hospital. Additionally, vinyl packing can cause suffocation. Keep it out of the reach of children.



- Do not let your children climb or cling onto the TV. Otherwise, the TV may fall over, which may cause serious injury.



- Dispose of used batteries carefully to protect a child from eating them. In case that it eats them, take it to see a doctor immediately.



- Do not insert a conductor (like a metal chopstick) into one end of the power cable while the other end is connected to the input terminal on the wall. Additionally, do not touch the power cable right after plugging into the wall input terminal. You may be electrocuted.



- Do not put or store inflammable substances near the product. There is a danger of explosion or fire due careless handling of the inflammable substances.



- Do not drop metallic objects such as coins, hair pins, chopsticks or wire into the product, or inflammable objects such as paper and matches. Children must pay particular attention. Electrical shock, fire or injury can occur. If a foreign object is dropped into the product, unplug the power cord and contact the service centre.



- Do not spray water on the product or scrub with an inflammable substance (thinner or benzene). Fire or electric shock accident can occur.



- Do not allow a impact shock or any objects to fall into the product, and do not drop onto the screen with something.
You may be injured or the product can be damaged.



- Never touch this product or antenna during a thunder or lighting storm.
You may be electrocuted.

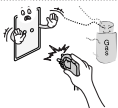

- Never touch the wall outlet when there is leakage of gas, open the windows and ventilate.
It may cause a fire or a burn by a spark.



- Do not disassemble, repair or modify the product at your own discretion.
Fire or electric shock accident can occur.
Contact the service center for check, calibration or repair.



- If any of the following occur, unplug the product immediately and contact your local service centre.
 - The product has been impacted by shock
 - The product has been damaged
 - Foreign objects have entered the product
 - The product produced smoke or a strange smell
 This may result in fire or electric shock.



- If you don't intend to use the product for a long time, unplug the power cable from the product.
Covering dust can cause a fire, or insulation deterioration can cause electric leakage, electric shock or fire.



- Apparatus shall not be exposed to dripping or splashing and no objects filled with liquids, such as vases, shall be placed on the apparatus.



CAUTION



- Install the product where no radio wave occurs.

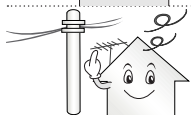

- There should be enough distance between an outside antenna and power lines to keep the former from touching the latter even when the antenna falls. This may cause an electric shock.



- Do not install the product on places such as unstable shelves or inclined surfaces. Also avoid places where there is vibration or where the product cannot be fully supported. Otherwise, the product may fall or flip over, which may cause injury or damage to the product.

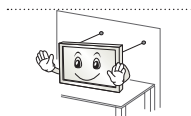

- If you install the TV on a stand, you need to take actions to prevent the product from overturning. Otherwise, the product may fall over, which may cause injury.

- If you intend to mount the product to a wall, attach VESA standard mounting interface (optional parts) to the back of the product. When you install the set to use the wall mounting bracket (optional parts), fix it carefully so as not to drop.

- Only use the attachments / accessories specified by the manufacturer.

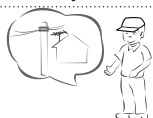

- When installing the antenna, consult a qualified service man. This may create a fire hazard or an electric shock hazard.

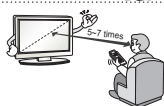

- We recommend that you maintain a distance of at least 5 to 7 times the diagonal screen size when watching TV. If you watch TV for a long period of time, this may cause blurred vision.

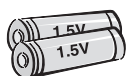

- Only use the specified type of battery. This could cause damage to the remote control.

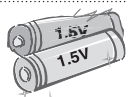

- Do not mix new batteries with old batteries. This may cause the batteries to overheat and leak.



- Make sure there are no objects between the remote control and its sensor.



- Signal from the remote control may be disturbed by sun light or other strong light. In this case, darken the room.

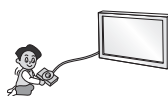

- When connecting external devices such as video game consoles, make sure the connecting cables are long enough. Otherwise, the product may fall over, which may cause injury or damage the product.



- Do not turn the product On/Off by plugging-in or unplugging the power plug to the wall outlet. (Do not use the power plug for switch.) It may cause mechanical failure or could give an electric shock.

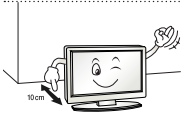

- Please follow the installation instructions below to prevent the product from overheating.
 - The distance between the product and the wall should be more than 10 cm.
 - Do not install the product in a place with no ventilation (e.g., on a bookshelf or in a cupboard).
 - Do not install the product on a carpet or cushion.
 - Make sure the air vent is not blocked by a tablecloth or curtain.

Otherwise, this may result in fire.

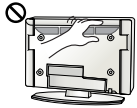

- Take care not to touch the ventilation openings when watching the TV for long periods as the ventilation openings may become hot. This does not affect the operation or performance of the product.

- Periodically examine the cord of your appliance, and if its appearance indicates damage or deterioration, unplug it, discontinue use of the appliance, and have the cord replaced with an exact replacement part by an authorized servicer.



- Prevent dust collecting on the power plug pins or outlet. This may cause a fire hazard.

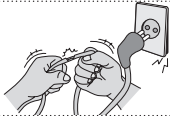

- Protect the power cord from physical or mechanical abuse, such as being twisted, kinked, pinched, closed in a door, or walked upon. Pay particular attention to plugs, wall outlets, and the point where the cord exits the appliance.



- Do not press strongly upon the panel with a hand or sharp object such as nail, pencil or pen, or make a scratch on it.



- Avoid touching the screen or holding your finger(s) against it for long periods of time. Doing so may produce some temporary distortion effects on the screen.



- When cleaning the product and its components, unplug the power first and wipe it with a soft cloth. Applying excessive force may cause scratches or discolouration. Do not spray with water or wipe with a wet cloth. Never use glass cleaner, car or industrial shiner, abrasives or wax, benzene, alcohol etc., which can damage the product and its panel. Otherwise, this may result in fire, electric shock or product damage (deformation, corrosion or breakage).

- As long as this unit is connected to the AC wall outlet, it is not disconnected from the AC power source even if you turn off this unit by SWITCH.



- When unplugging the cable, grab the plug and unplug it. If the wires inside the power cable are disconnected, this may cause fire.



- When moving the product, make sure you turn the power off first. Then, unplug the power cables, antenna cables and all connecting cables. The TV set or power cord may be damaged, which may create a fire hazard or cause electric shock.



- When moving or unpacking the product, work in pairs because the product is heavy. Otherwise, this may result in injury.



- Contact the service center once a year to clean the internal parts of the product. Accumulated dust can cause mechanical failure.



- Refer all servicing to qualified service personnel. Servicing is required when the apparatus has been damaged in any way, such as power supply cord or plug is damaged, liquid has been spilled or objects have fallen into the apparatus, the apparatus has been exposed to rain or moisture, does not operate normally, or has been dropped.



- If the product feels cold to the touch, there may be a small “flicker” when it is turned on. This is normal, there is nothing wrong with product.



- The panel is a high technology TFT product with resolution of two million to six million pixels. You may see tiny black dots and/or brightly coloured dots (red, blue or green) at a size of 1 ppm on the panel. This does not indicate a malfunction and does not affect the performance and reliability of the product. This phenomenon also occurs in third-party products and is not subject to exchange or refund.



- You may find different brightness and color of the panel depending on your viewing position(left/right/top/down). This phenomenon occurs due to the characteristic of the panel. It is not related with the product performance, and it is not malfunction.

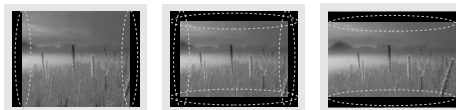

- Displaying a still image (e.g., broadcasting channel logo, on-screen menu, scene from a video game) for a prolonged time may cause damage to the screen, resulting in retention of the image, which is known as image sticking. The warranty does not cover the product for image sticking. Avoid displaying a fixed image on your television's screen for a prolonged period (2 or more hours for LCD, 1 or more hours for Plasma). Also, if you watch the TV at a ratio of 4:3 for a long time, image sticking may occur on the borders of the panel. This phenomenon also occurs in third-party products and is not subject to exchange or refund.

• Generated Sound

“Cracking” noise: A cracking noise that occurs when watching or turning off the TV is generated by plastic thermal contraction due to temperature and humidity. This noise is common for products where thermal deformation is required. Electrical circuit humming/panel buzzing: A low level noise is generated from a high-speed switching circuit, which supplies a large amount of current to operate a product. It varies depending on the product.

This generated sound does not affect the performance and reliability of the product.

NOTE

- Image shown may differ from your TV.
- Your TV's OSD (On Screen Display) may differ slightly from that shown in this manual.
- The available menus and options may differ from the input source or product model that you are using.
- New features may be added to this TV in the future.
- The TV can be placed in standby mode in order to reduce the power consumption. And the TV should be turned off if it will not be watched for some time, as this will reduce energy consumption.
- The energy consumed during use can be significantly reduced if the level of brightness of the picture is reduced, and this will reduce the overall running cost.

INSTALLATION PROCEDURE

- 1 Open the package and make sure all the accessories are included.
- 2 Attach the stand to the TV set.
- 3 Connect an external device to the TV set.
- 4 Make sure the network connection is available.
You can use the TV network functions only when the network connection is made.

ASSEMBLING AND PREPARING

Unpacking

Check your product box for the following items. If there are any missing accessories, contact the local dealer where you purchased your product. The illustrations in this manual may differ from the actual product and item.

CAUTION

- Do not use any unapproved items to ensure the safety and product life span.
- Any damages or injuries by using unapproved items are not covered by the warranty.

NOTE



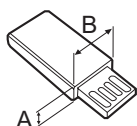
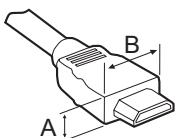



- The items supplied with your product may vary depending on the model.
- Product specifications or contents of this manual may be changed without prior notice due to upgrade of product functions.
- For an optimal connection, HDMI cables and USB devices should have bezels less than 10 mm thick and 18 mm width. Use an extension cable that supports USB 2.0 if the USB cable or USB memory stick does not fit into your TV's USB port.

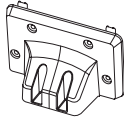
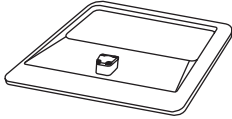
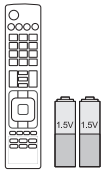

*A ≦ 10 mm

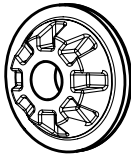
*B ≦ 18 mm

The illustrations in this manual may differ from the actual product and item.

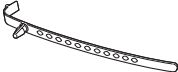
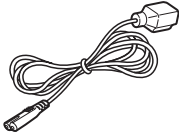
		
TV Body	Stand Body	Stand Base
		 X4 EA
Remote control and batteries (AAA)	Owner's Manual	Wall mount inner spacers
	 X8 EA M4 X 20	
Polishing Cloth Use this to remove dust from the cabinet.	Stand Screws	Desk-mount Screw
		
Cable Holder	Power Cord	

Separate purchase

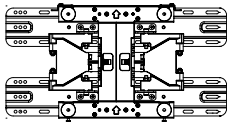
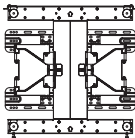
	
Wall Mounting Bracket LSW200BX, LSW200BXG See P15	Wall Mounting Bracket LSW400BX, LSW400BXG See P15

Parts and buttons

CAUTION

- Do not use any unapproved items to ensure the safety and product life span.
- Any damages or injuries by using unapproved items are not covered by the warranty.
- Some models have a thin film attached on to the screen and this must not be removed.

Image shown may differ from your TV.

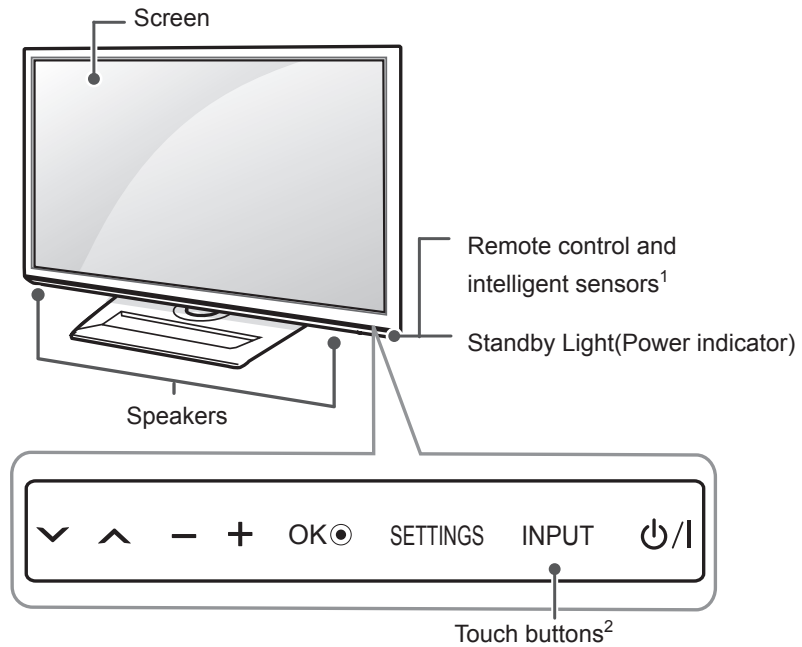

Touch button	Description
∨ ^	Scrolls through the saved programmes.
- +	Adjusts the volume level.
OK ●	Selects the highlighted menu option or confirms an input.
SETTINGS	Accesses the main menu, or saves your input and exits the menus.
INPUT	Changes the input source.
⏻ / I	Turns the power on or off.

1 Intelligent sensor - Adjusts the image quality and brightness based on the surrounding environment.

2 All buttons are touch sensitive and can be operated through simple touch with your finger.

NOTE

- You can set the Standby Light to on or off by selecting **OPTION** in the main menus.

Lifting and moving the TV

When moving or lifting the TV, read the following to prevent the TV from being scratched or damaged and for safe transportation regardless of its type and size.



CAUTION

- Avoid touching the screen at all times, as this may result in damage to the screen.
- It is recommended to move the TV in the box or packing material that the TV originally came in.
- Before moving or lifting the TV, disconnect the power cord and all cables.
- When holding the TV, the screen should face away from you to avoid damage.

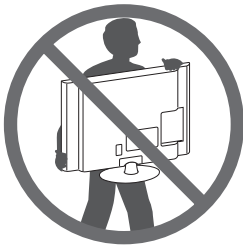

- Hold the top and bottom of the TV frame firmly. Make sure not to hold the transparent part, speaker, or speaker grill area.

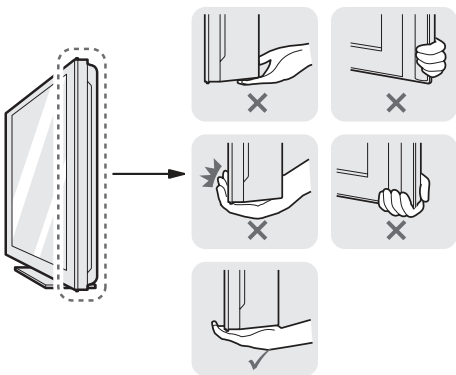

- When transporting a large TV, there should be at least 2 people.
- When transporting the TV by hand, hold the TV as shown in the following illustration.

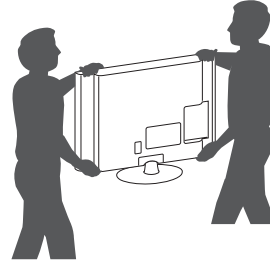

- When transporting the TV, do not expose the TV to jolts or excessive vibration.
- When transporting the TV, keep the TV upright, never turn the TV on its side or tilt towards the left or right.

Setting up the TV

Image shown may differ from your TV.

1

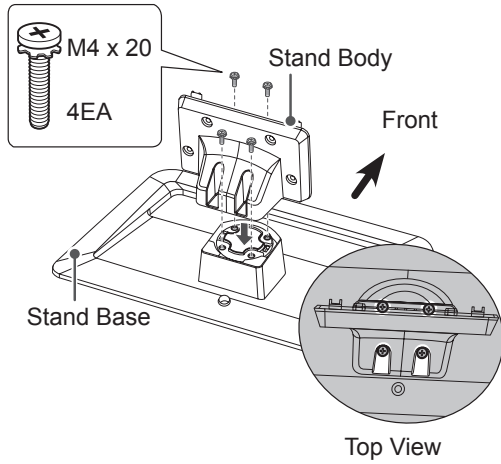

2

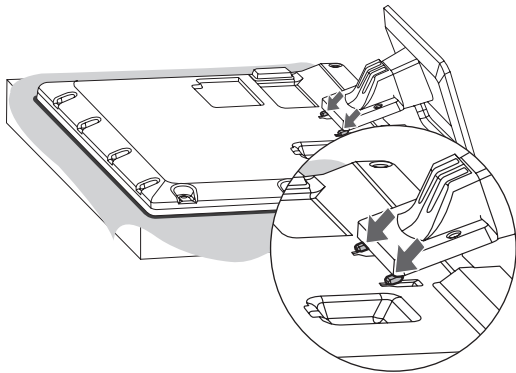

3

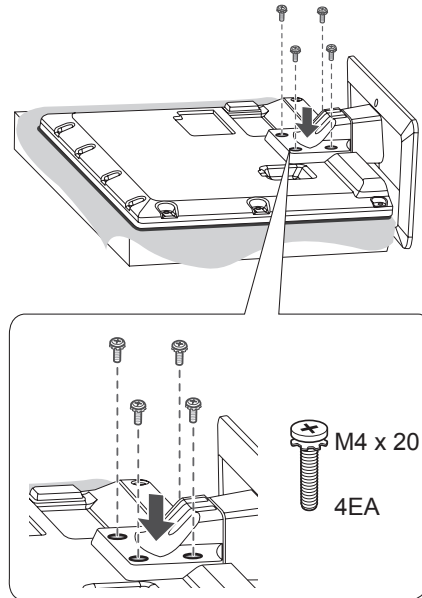

CAUTION

- When attaching the stand to the TV set, place the screen facing down on a cushioned table or flat surface to protect the screen from scratches.
- Tighten the screws firmly to prevent the TV from tilting forward. Do not over tighten.

NOTE

Remove the stand before installing the TV on a wall mount by performing the stand attachment in reverse.

Mounting on a table

- Lift and tilt the TV into its upright position on a table.
 - Leave a 10 cm (minimum) space from the wall for proper ventilation.

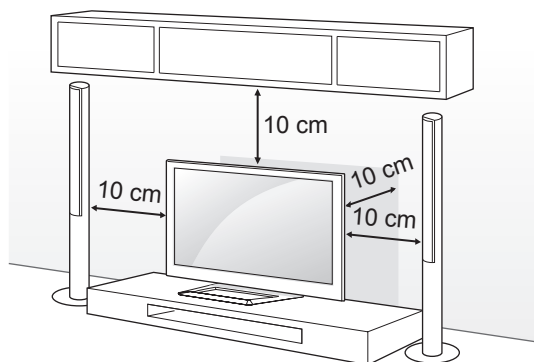

- Connect the power cord to a wall outlet.



CAUTION

- Do not place the TV near or on sources of heat, as this may result in fire or other damage.

Securing the TV to a table

Fix the TV to a table to prevent from tilting forward, damage, and potential injury.

To secure the TV to a table, insert and tighten the supplied screw on the rear of the stand. Image shown may differ from your TV.

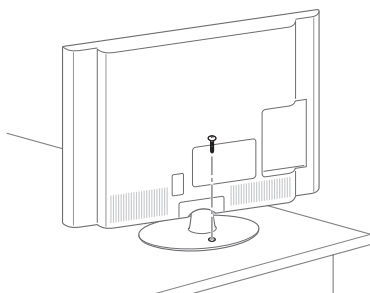

Adjusting the angle of the TV to suit view

(This feature is not available for all models.)

Adjusting the angle of the TV to suit view swivel 20 ± 2 degrees to the left or right and adjust the angle of the TV to suit your view.

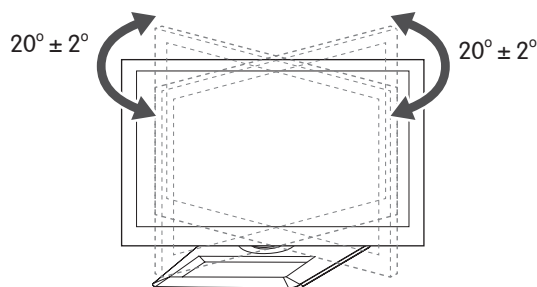

CAUTION

- When adjusting the angle of the product, watch out for your fingers.
 - Personal injury may occur if hands or fingers are pinched. If the product is tilted too much, it may fall, causing damage or injury.

Using the Kensington security system

(This feature is not available for all models)

The Kensington security system connector is located at the rear of the TV. For more information of installation and using, refer to the manual provided with the Kensington security system or visit <http://www.kensington.com>.

Connect the Kensington security system cable between the TV and a table.

Image shown may differ from your TV.

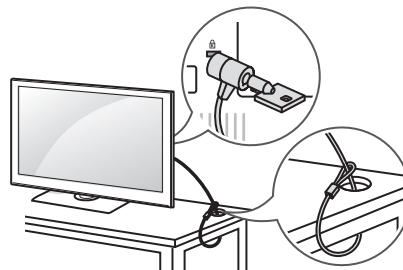

NOTE: Kensington security system need buy from local dealer where you purchased your product.

Securing the TV to a wall

(This feature is not available for all models.)

- 1 Insert and tighten the eye-bolts, or TV brackets and bolts on the back of the TV.
 - If there are bolts inserted at the eye-bolts position, remove the bolts first.
- 2 Mount the wall brackets with the bolts to the wall.

Match the location of the wall bracket and the eye-bolts on the rear of the TV.
- 3 Connect the eye-bolts and wall brackets tightly with a sturdy rope.

Make sure to keep the rope horizontal with the flat surface.

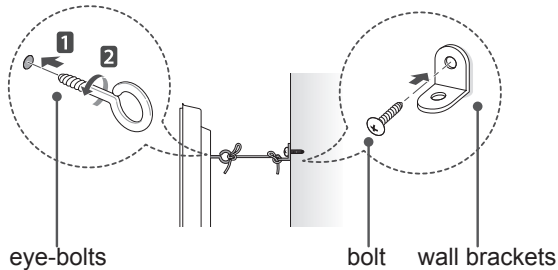
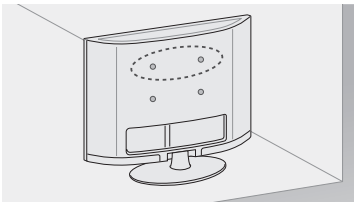

CAUTION

- Make sure that children do not climb on or hang on the TV.

NOTE

- Use a platform or cabinet that is strong and large enough to support the TV securely.

Mounting on a wall

Attach an optional wall mount bracket at the rear of the TV carefully and install the wall mount bracket on a solid wall perpendicular to the floor. When you attach the TV to other building materials, please contact qualified personnel. LG recommends that wall mounting be performed by a qualified professional installer.

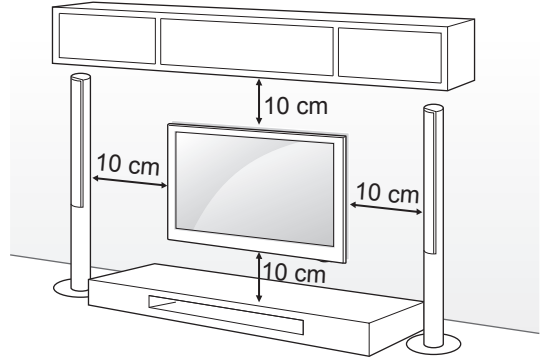

Make sure to use screws and wall mount bracket that meet the VESA standard. Standard dimensions for the wall mount kits are described in the following table.

Separate purchase (Wall Mounting Bracket)

Model	32/37LS5600	42/47LS5600
VESA	200 x 200	400 x 400
Standard screw	M6	M6
Number of screws(EA)	4	4
Wall mount bracket	LSW200BX, LSW200BXG	LSW400BX, LSW400BXG

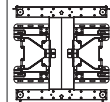
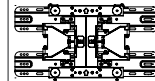

**CAUTION**

- Disconnect the power first, and then move or install the TV. Otherwise electric shock may occur.
- If you install the TV on a ceiling or slanted wall, it may fall and result in severe injury. Use an authorized LG wall mount and contact the local dealer or qualified personnel.
- Do not over tighten the screws as this may cause damage to the TV and void your warranty.
- Use the screws and wall mounts that meet the VESA standard. Any damages or injuries by misuse or using an improper accessory are not covered by the warranty.

**NOTE**

- Use the screws that are listed on the VESA standard screw specifications.
- The wall mount kit includes an installation manual and necessary parts.
- The wall mount bracket is optional. You can obtain additional accessories from your local dealer.
- The length of screws may differ depending on the wall mount. Make sure to use the proper length.
- For more information, refer to the manual supplied with the wall mount.
- Place the wall mount inner spacers on the set before installing the wall mounting bracket so that the inclination of the backside of the set can be adjusted perpendicularly.

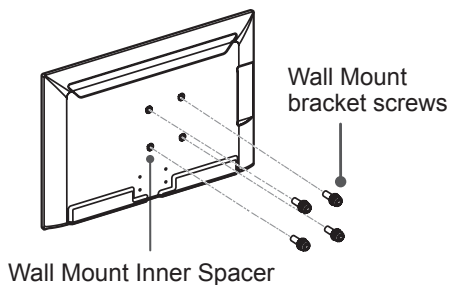
**Tidying cables**

- 1 Gather and bind the cables with the Cable Holder.

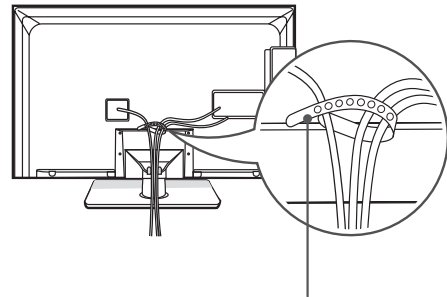

Cable Holder

**CAUTION**

- Do not move the TV by holding the cable holders, as the cable holders may break, and injuries and damage to the TV may occur.

MAKING CONNECTIONS

The illustrations in this manual may differ from the actual product and item.

Connect various external devices to the TV and switch input modes to select an external device. For more information of external device's connection, refer to the manual provided with each device.

Available external devices are: HD receivers, DVD players, VCRs, audio systems, USB storage devices, PC, gaming devices, and other external devices.

! NOTE

- The external device connection may differ from the model.
- Connect external devices to the TV regardless of the order of the TV port.
- If you record a TV program on a DVD recorder or VCR, make sure to connect the TV signal input cable to the TV through a DVD recorder or VCR. For more information of recording, refer to the manual provided with the connected device.
- Refer to the external equipment's manual for operating instructions.
- If you connect a gaming device to the TV, use the cable supplied with the gaming device.
- In PC mode, there may be noise associated with the resolution, vertical pattern, contrast or brightness. If noise is present, change the PC output to another resolution, change the refresh rate to another rate or adjust the brightness and contrast on the PICTURE menu until the picture is clear.
- In PC mode, some resolution settings may not work properly depending on the graphics card.

Antenna connection

Connect the TV to a wall antenna with an RF cable (75Ω).

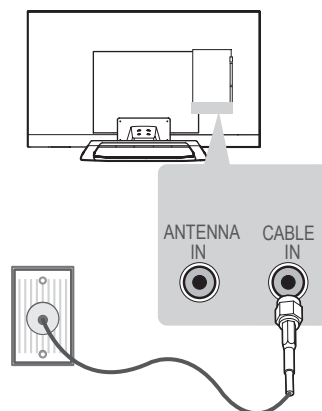

! NOTE

- Use a signal splitter to use more than 2 TVs.
- If the image quality is poor, install a signal amplifier properly to improve the image quality.
- If the image quality is poor with an antenna connected, try to realign the antenna in the correct direction.
- An antenna cable and converter are not supplied.

HDMI connection

Transmits the digital video and audio signals from an external device to the TV. Connect the external device and the TV with the HDMI cable as shown in the following illustration.

Choose any HDMI input port to connect. It does not matter which port you use.

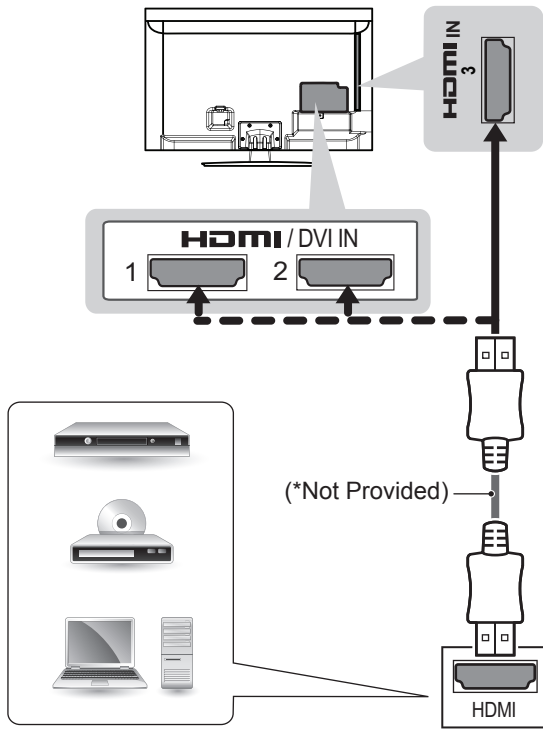

DVD/ Blu-Ray / HD Cable Box / HD STB / PC

NOTE

- It is recommended to use the HDMI connection for the best image quality.
- Use the latest High Speed HDMI™ Cable with CEC (Customer Electronics Control) function.
- High Speed HDMI™ Cables are tested to carry an HD signal up to 1080p and higher.
- DTV Audio supported Codec: MPEG, Dolby Digital
- HDMI Audio supported format : Dolby Digital, PCM (Up to 192 KHz, 32k/44.1k/48k /88k/96k/176k/192k) → Not supported DTS

DVI to HDMI connection

Transmits the digital video signal from an external device to the TV. Connect the external device and the TV with the DVI-HDMI cable as shown in the following illustration. To transmit an audio signal, connect an audio cable.

Choose any HDMI input port to connect. It does not matter which port you use.

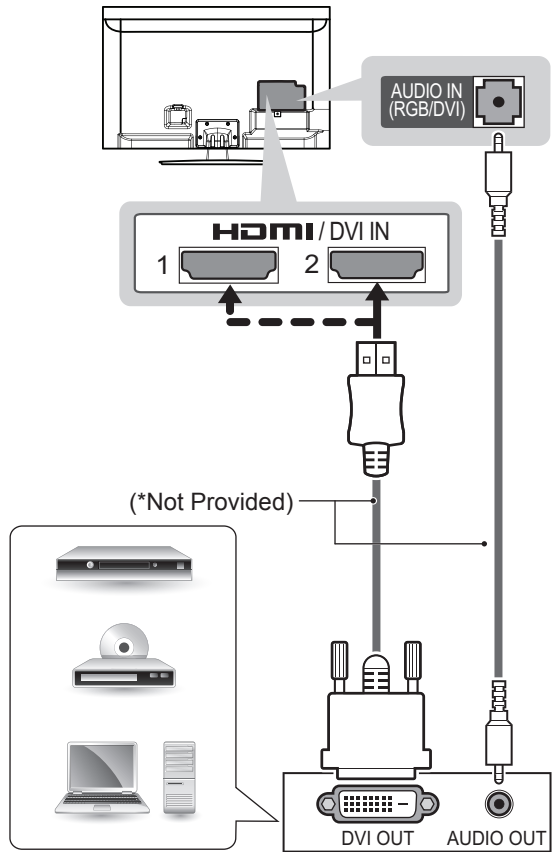

DVD/ Blu-Ray / HD Cable Box / PC

NOTE

- Depending on the graphics card, DOS mode video may not work if a HDMI to DVI Cable is in use.

Component connection

Transmits analog video and audio signals from an external device to the TV. Connect the external device and the TV with a component cable as shown in the following illustration.

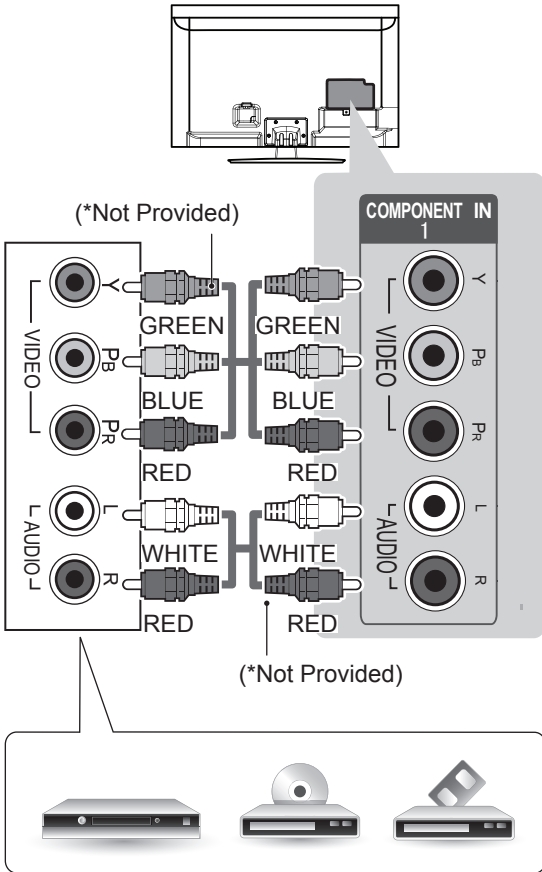

DVD / Blu-Ray / HD Cable Box

Composite connection

Transmits analog video and audio signals from an external device to the TV. Connect the external device and the TV with the composite cable as shown in the following illustration.

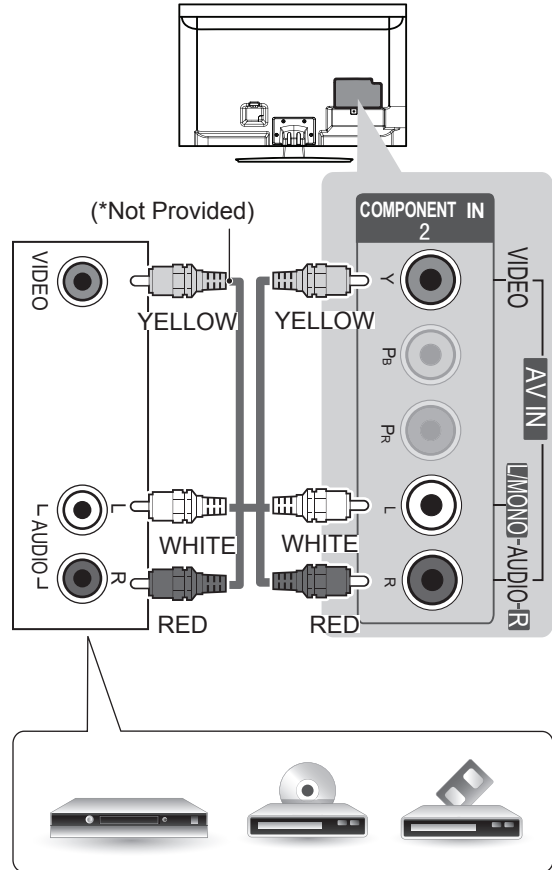

VCR / DVD / Blu-Ray / HD Cable Box

NOTE

- If cables are installed incorrectly, it could cause the image to display in black and white or with distorted color.
- Check to ensure the cables are matched with the corresponding color connection.

NOTE

- If cables are installed incorrectly, it could cause the image to display in black and white or with distorted color.
- Check to ensure the cables are matched with the corresponding color connection.

RGB-PC connection

Transmits the video signal from PC to the TV. To transmit an audio signal, connect an audio cable.

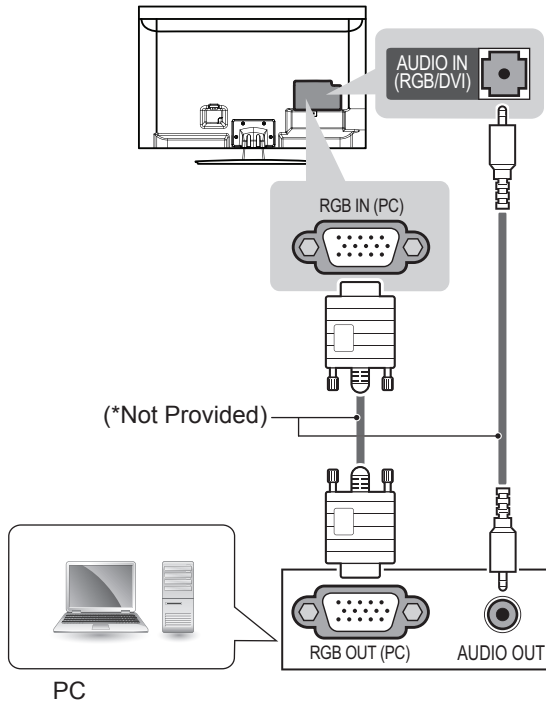

Digital optical audio connection

Transmits a digital audio signal from the TV to an external device. Connect the external device and the TV with the optical audio cable as shown in the following illustration.

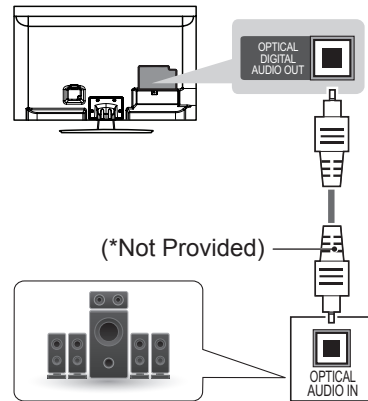

Digital Audio System



NOTE

- Do not look into the optical output port. Looking at the laser beam may damage your vision.
- Audio with ACP (Audio Copy Protection) function may block digital audio output.

USB connection

Connect a USB storage device such as a USB flash memory, external hard drive, or a USB memory card reader to the TV and access the Smart Share menu to use various multimedia files.

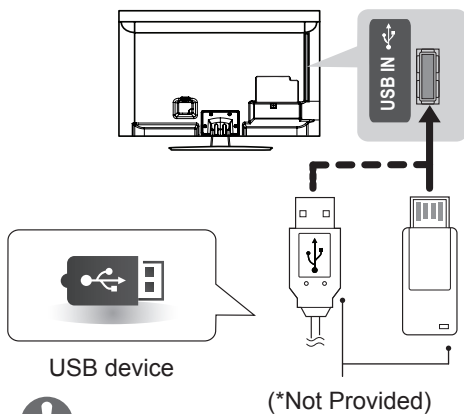

NOTE

- Please move USB away before turn TV off.

Audio connection

You may use an optional external audio system instead of the built-in speaker.



NOTE

- If you use an optional external audio device instead of the built-in speaker, set the TV speaker feature to off.

REMOTE CONTROL

The descriptions in this manual are based on the buttons on the remote control.

Please read this manual carefully and use the TV correctly.

To replace batteries, open the battery cover, replace batteries (1.5 V AAA) matching the ⊕ and ⊖ ends to the label inside the compartment, and close the battery cover.

To remove the batteries, perform the installation actions in reverse.

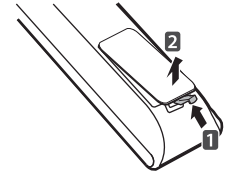









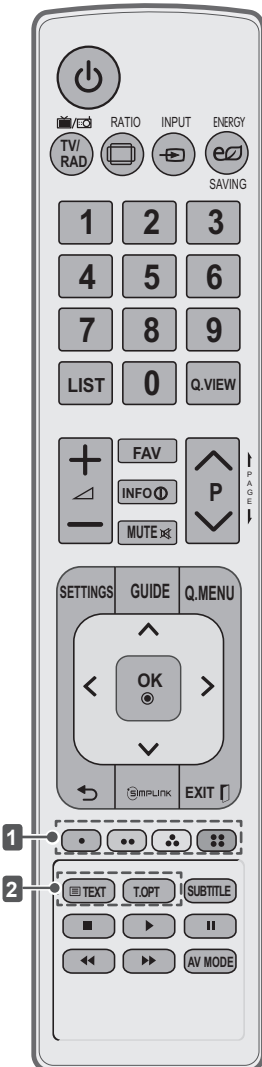





ENGLISH

CAUTION

- Do not mix old and new batteries, as this may damage the remote control.

Make sure to point the remote control toward the remote control sensor on the TV.



 (POWER)	Turns the TV on or off.
 TV / RAD	Selects Radio, TV and DTV programme.
 RATIO	Resizes an image.
 INPUT	Changes the input source; Turns the TV on.
 ENERGY SAVING	Adjusts the brightness of the screen to reduce energy consumption.
Number button	Enters numbers.
 LIST	Accesses the saved programme list.
 Q.VIEW	Returns to the previously viewed programme.
	Adjusts the volume level.
 FAV	Accesses your favourite programme list.
 INFO <i>Ⓢ</i>	Views the information of the currently programme and the screen.
MUTE	Mutes all sounds.
 p ^ v	Scrolls through the saved programmes.
PAGE	Moves to the previous or next screen.
SETTINGS	Accesses the main menus.
GUIDE	Shows programme guide.
Q.MENU	Accesses the Quick menus.
Navigation buttons (up/down/left/right)	Scrolls through menus or options.
 OK	Select menus or options and confirms your input.
	Returns to the previous level.
SIMPLINK	Accesses the AV devices connected to the TV; Opens the SIMPLINK menu.
EXIT	Clears all on-screen displays and return to TV viewing.
1 Coloured buttons	These access special functions in some menus. (●:Red, ●:Green, ●:Yellow, ●:Blue)
2 TELETEXT BUTTONS	These buttons are used for teletext.
SUBTITLE	Recalls your preferred subtitle in digital mode.
COUNTROL BUTTONS (■, ▶, II, ◀, ▶)	Control MY MEDIA menus or the SIMPLINK compatible devices(USB,SIMPLINK)
AV MODE	Selects an AV mode.

USING THE USER GUIDE

ENGLISH

User Guide allows you to more easily access the detailed TV information.

The illustrations in this manual may differ from the actual product and item.

- 1 Press **SETTINGS** to access the main menus.
- 2 Press the **RED** button to access the **Customer Support** menus.
- 3 Press the Navigation buttons to scroll to **User Guide** and press **OK**.

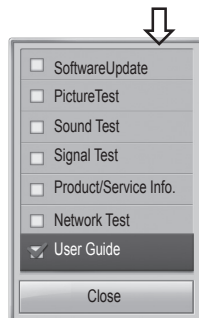

- 1 Allows to select the category you want.
- 2 Allows to select the item you want.
You can use \wedge \vee to move between pages.
- 3 Allows to browse the description of the function you want from the index.

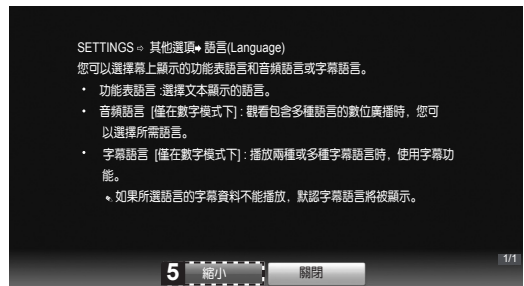
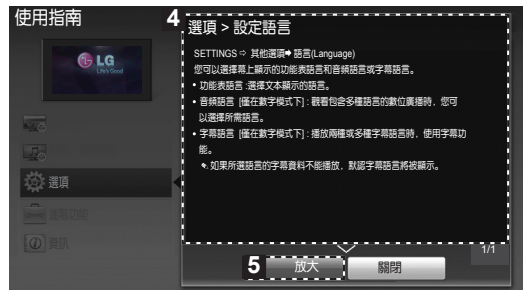

- 4 Shows the description of the selected menu.
You can use \wedge \vee to move between pages.
- 5 Zooms in or out the screen.

MAINTENANCE

Cleaning your TV

Clean your TV regularly to keep the best performance and to extend the product lifespan.

Screen, frame, cabinet and stand

- To remove dust or light dirt, wipe the surface with a dry, clean, and soft cloth.
- To remove major dirt, wipe the surface with a soft cloth dampened in clean water or a diluted mild detergent. Then wipe immediately with a dry cloth.



CAUTION

- Avoid touching the screen at all times, as this may result in damage to the screen.
- Do not push, rub, or hit the screen surface with your fingernail or a sharp object, as this may result in scratches and image distortions.
- Do not use any chemicals as this may damage the product.
- Do not spray liquid onto the surface. If water enters the TV, it may result in fire, electric shock, or malfunction.

Power cord

Remove the accumulated dust or dirt on the power cord regularly.

TROUBLESHOOTING

Problem	Resolution
Cannot control the TV with the remote control.	<ul style="list-style-type: none"> • Check the remote control sensor on the product and try again. • Check if there is any obstacle between the product and the remote control. • Check if the batteries are still working and properly installed (⊕ to ⊕, ⊖ to ⊖).
No image display and no sound is produced.	<ul style="list-style-type: none"> • Check if the product is turned on. • Check if the power cord is connected to a wall outlet. • Check if there is a problem in the wall outlet by connecting other products.
The TV turns off suddenly.	<ul style="list-style-type: none"> • Check the power control settings. The power supply may be interrupted. • Check if the Auto sleep feature is activated in the Time settings. • If there is no signal while the TV is on, the TV will turn off automatically after 15 minutes of inactivity.
When connecting to the PC (RGB/ HDMI DVI), 'No signal' or 'Invalid Format' is displayed.	<ul style="list-style-type: none"> • Turn the TV off/on using the remote control. • Reconnect the RGB/HDMI cable. • Restart the PC with the TV on.

SPECIFICATIONS

Product specifications may be changed without prior notice due to upgrade of product functions.

ENGLISH

ITEM		MODELS	
		32LS5600	37LS5600
Product Dimensions (W X H X D)	With stand	746.0mm x 527.0mm x 204.0mm	856.0mm x 590mm x 204.0mm
	Without stand	746.0mm x 462.0mm x 52.2mm	856.0mm x 524.0mm x 52.2mm
Product Weight	With stand	9.7Kg	12.4Kg
	Without stand	8.4Kg	10.5Kg
Prower requirement		AC 100-240V~50/60Hz	AC 100-240V~50/60Hz

ITEM		MODELS	
		42LS5600	47LS5600
Product Dimensions (W X H X D)	With stand	979.0 mm x 660.0 mm x 269.0 mm	1089.0 mm x 720.0 mm x 269.0 mm
	Without stand	979.0 mm x 594.0 mm x 52.2 mm	1089.0 mm x 655.0 mm x 52.2 mm
Product Weight	With stand	15.1 Kg	17.8 Kg
	Without stand	12.6 Kg	15.3 Kg
Prower requirement		AC 100-240V~50/60Hz	AC 100-240V~50/60Hz

ITEM		MODELS	
		32/37/42/47LS5600	
Environment condition	operating Temperature	0~40° C	
	operating Humidity	Less than 80 %	
	Storage Temperature	-20~60° C	
	Storage Humidity	Less than 85 %	



Record the model number and serial number of the TV.

Refer to the label on the back cover and quote this information to your dealer when requiring any service.

MODEL _____

SERIAL _____