



**Agilent Technologies**

M1771A  
M1770A

**PageWriter 200/300pi  
User's Guide**



---

**PageWriter 200/300pi  
M1771A/1770A Cardiograph**

## About This Edition

Edition 2  
Printed in the USA  
Publication number M1770-91930

The information in this guide applies to the M1771/M1770 PageWriter 200/300pi Cardiograph. This information is subject to change without notice. Agilent Technologies shall not be liable for errors contained herein or for incidental or consequential damages in connection with the furnishing, performance, or use of this material.

## Edition History

Edition 1, August 1998  
Edition 2, November 1999

## Copyright

Copyright © 1999  
Agilent Technologies, Inc.  
3000 Minuteman Road  
Andover, MA 01810-1099  
USA  
(978) 687-1501

This document may not be photocopied, reproduced, or translated to another language without prior written consent of Agilent Technologies, Inc.

## WARNING

As with electronic equipment, **Radio Frequency (RF)** interference between the cardiograph and any existing RF transmitting or receiving equipment at the installation site, including electro-surgical equipment, should be evaluated carefully and any limitations noted before the equipment is placed in service.

Radio frequency generation from electro-surgical equipment and close proximity transmitters may seriously degrade performance.

Like all electronic devices, this cardiograph is susceptible to electrostatic discharge (ESD). Electrostatic discharge typically occurs when electrostatic energy is transferred to the patient, the electrodes, or the cardiograph. ESD may result in ECG artifact that may appear as narrow spikes on the cardiograph display or on the printed report. When ESD occurs, the cardiograph's ECG interpretation may be inconsistent with the physician's interpretation.

Agilent Technologies assumes no liability for failures resulting from RF interference between Agilent medical electronics and any radio frequency generating equipment at levels exceeding those established by applicable standards.

## CAUTION

Use of accessories other than those recommended by Agilent Technologies may compromise product performance.

**THIS PRODUCT IS NOT INTENDED FOR HOME USE.**

**IN THE U.S., FEDERAL LAW RESTRICTS THIS DEVICE TO SALE ON OR BY THE ORDER OF A PHYSICIAN.**

## Medical Device Directive

The M1771A/M1770A PageWriter 200/300pi Cardiograph complies with the requirements of the Medical Device Directive 93/42/EEC and carries the

 0123 mark accordingly.

Authorized EU-representative:  
Agilent Technologies Deutschland GmbH  
Herrenbergerstrasse 130  
D-71034 Boeblingen  
Germany  
Fax: +49-7031-14-2346

## Conventions

### Conventions Used in This Manual

---

**WARNING**

---

---

**Warning statements describe conditions or actions that can result in personal injury or loss of life.**

---

---

**CAUTION**

---

---

Caution statements describe conditions or actions that can result in damage to the equipment or software.

---

---

**NOTE**

---

---

Notes contain additional information on cardiograph usage.

---

 Represents keys on the key panel.

### Safety Summary

#### Safety Symbols Marked on the Cardiograph

The following safety symbols are used on the cardiograph.



Caution - See operating instructions.



Meets IEC type CF leakage current requirements and is defibrillator protected (Isolated ECG input).



Alternating current.



Equipotential (identifies independent protective earth conductor to the cardiograph).

## Conventions



Fuse.



Indicates power control for cardiograph.



Recycle.



Sealed Lead Acid Battery - Recycle or dispose of properly.

Hz

Indicates operating frequency in cycles per second.

Please see "Maintaining the Cardiograph", for further information about operating your cardiograph safely.

### Cardiograph Packaging Symbols

The following symbols appear on the packaging for the cardiograph:



Keep dry.



Temperature and relative humidity ranges.



Fragile.



Keep upright.

---

# Contents

Safety Symbols Marked on the Cardiograph .....	iii
--	-----

## Getting Acquainted

The Keyboard and Front Panel .....	1-4
About Your Cardiograph .....	1-8
Options .....	1-9
Patient and Operational Safety Notes .....	1-10
Electromagnetic Compatibility .....	1-11
Reducing Electromagnetic Interference .....	1-12
Restrictions for Use .....	1-12
AC and Battery Operation .....	1-12

## Recording an ECG

Preparing the Patient .....	2-2
Notes for Customers Using Reusable Electrodes .....	2-3
Notes for Customer Using Disposable Tab Electrodes .....	2-3
Understanding When a Signal is Acquired .....	2-4
Performing a Stat ECG (Bypassing Patient ID Entry) .....	2-4
Checking Signal Quality .....	2-5
Entering Patient ID .....	2-6
Reviewing and Changing Patient ID .....	2-8
Recording a Manual ECG .....	2-10
Restoring the ECG Trace After Defibrillation or Reconnecting Leads .....	2-12
Recording an Auto ECG .....	2-12
Making Copies of Auto ECGs .....	2-14
Understanding the Printed Report .....	2-15
Choosing a Report Format .....	2-15
Changing the Report Format .....	2-16
Auto Report Formats .....	2-16
Manual Report Formats .....	2-16
The Auto ECG Report .....	2-19
Auto Report Examples .....	2-23

Manual Report Examples ..... 2-27

**Understanding ECG Analysis and the Predictive Instruments Applications**

Understanding the ECG Analysis Program ..... 3-1  
How the PageWriter 200/300pi Measures ECGs ..... 3-3  
    Waveform Recognition ..... 3-4  
    Comprehensive Measurements ..... 3-4  
    Group Measurements ..... 3-5  
    Lead Measurements ..... 3-5  
    Atrial Rhythm Analysis ..... 3-5  
    Global Measurements ..... 3-6  
    Axis Measurements ..... 3-6  
Automatically Measuring and Interpreting ECGs ..... 3-7  
Understanding the Extended Measurements Report ..... 3-8  
    The Extended Measurements Report ..... 3-8  
    Morphology Analysis ..... 3-9  
    Rhythm Analysis ..... 3-16  
Understanding the PageWriter 300pi Predictive Instrument Applications ..... 3-21  
    Indications for Use ..... 3-22  
    Understanding TPI Variables ..... 3-23  
    Understanding ACI TIPI Variables ..... 3-24  
    Using the TPI and ACI TIPI Applications ..... 3-25  
    Analyzing an ECG with the Predictive Instruments ..... 3-26  
    Obtaining Alternate Reports ..... 3-26

**ECG Storage (Options #A05 or StressWriter)**

Advantages of Storage ..... 4-1  
Storing ECGs ..... 4-2  
Managing Stored ECGs ..... 4-4  
    Selecting Stored ECGs ..... 4-4  
    Printing Stored ECGs ..... 4-6  
    Deleting Stored ECGs ..... 4-6  
    Editing Patient ID for Stored ECGs ..... 4-7  
Printing the Log of ECGs Taken or the Log of ECGs Stored ..... 4-8

**Transmitting, Faxing, and Receiving Auto ECGs (Options #A05 or StressWriter only)**

Transmitting ECGs ..... 5-1  
    Changing a Telephone Directory Entry ..... 5-6  
Receiving ECGs ..... 5-8  
    Receiving ECGs sent by a Remote Device ..... 5-8  
    Requesting ECGs from a Remote Device ..... 5-9

**Troubleshooting**

Checking ECG Technique ..... 6-1  
Identifying ECG Problems ..... 6-2  
    If the Recording Won't Start ..... 6-4  
    If the Cardiograph Won't Print a Manual Report ..... 6-5  
Error Messages ..... 6-5  
Identifying Storage Problems (Options #A05 or StressWriter only) ..... 6-6  
Identifying Transmission Problems (Options #A05 or StressWriter only) ..... 6-7

**Maintaining the Cardiograph**

Care and Cleaning ..... 7-1  
    Cleaning the Cardiograph ..... 7-1  
    Cleaning the Electrodes and Cables ..... 7-2  
    Cleaning the Digital Array Printhead and Paper Sensor ..... 7-3  
Loading the Paper ..... 7-5  
    Storing the Paper and Patient ECG Records ..... 7-6  
Caring for the Battery ..... 7-7  
    Storing the Battery ..... 7-8  
Replacing the Fuses ..... 7-8  
    To replace the AC fuses: ..... 7-8  
Supplies ..... 7-10  
Calling for Service ..... 7-13  
    United States of America ..... 7-13  
    Canada ..... 7-13  
    Other International Areas ..... 7-13



## Setting Up Your Cardiograph

Checking the Voltage Setting .....	A-1
The Battery .....	A-3
Installing the Battery .....	A-3
Connecting the Cables .....	A-6
Loading Paper .....	A-8
Setting the Keyboard Mode .....	A-9
Setting the Cardiograph Location and ID Codes (Options #A05 or StressWriter only) .....	A-10
Connecting the Direct Transmission Cable (Options #A05 or StressWriter only) .....	A-11
Transmitting or Faxing ECGs by Modem (Options #A05 or StressWriter only) .....	A-13
Setting Up the Telephone Directory (Options #A05 or StressWriter only) .....	A-15
Setting Up Predictive Instruments .....	A-19

## Configuring Your Cardiograph

The Configuration Menu .....	B-2
Navigating the Configuration Menus .....	B-7
Patient ID Entries .....	B-8
Power-On Report Fields .....	B-11
Filters .....	B-12
Miscellaneous Report Fields .....	B-14
Setting Date and Time .....	B-16
Printing the Configuration .....	B-17
Adjusting Display Screen Contrast .....	B-17
Set-up Transmission (Options #A05 or StressWriter only) .....	B-17

## Specifications

Basic Controls .....	C-1
Frequency and Impulse Response .....	C-3
Instrument Test .....	C-3
Patient Safety .....	C-3

Power and Environment .....C-3

---

Contents

# 1 Getting Acquainted

This chapter describes to the new user the many features of the PageWriter 200/300pi cardiograph, patient and operational safety, A/C, and battery operation. The user should become familiar with this material, especially the safety information, prior to using the cardiograph.

---

**NOTE**

---

---

See Setting Up Your Cardiograph, for information on checking the voltage switch setting, installing the battery, connecting the cables, and loading paper. Each of these tasks **must** be done prior to operating the cardiograph for the first time.

If accurate ST segment contours are required for ECGs recorded in Manual mode, do not use the 0.5 Hz baseline wander filter. This filter suppresses baseline wander to the extent that it may alter the ST segment. Instead, configure your cardiograph to use the 0.15 Hz or 0.05 Hz baseline wander filter. Regardless of the filter used, the rhythm characteristics of the ECG are accurately recorded.

---

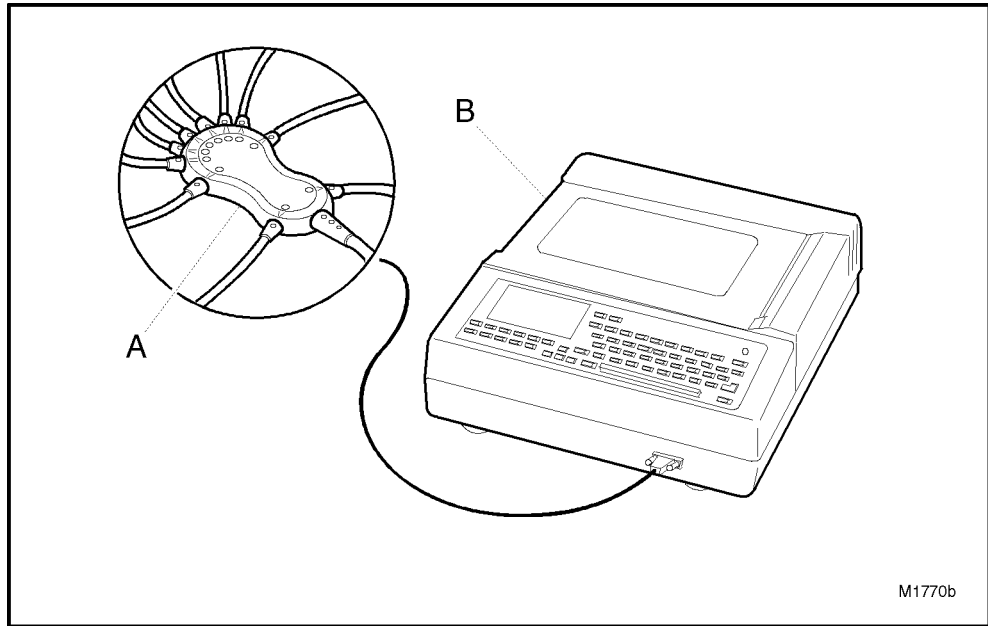

**Figure 1-1: The PageWriter 200/300pi Cardiograph**

- A. Patient Cable
- B. Cardiograph

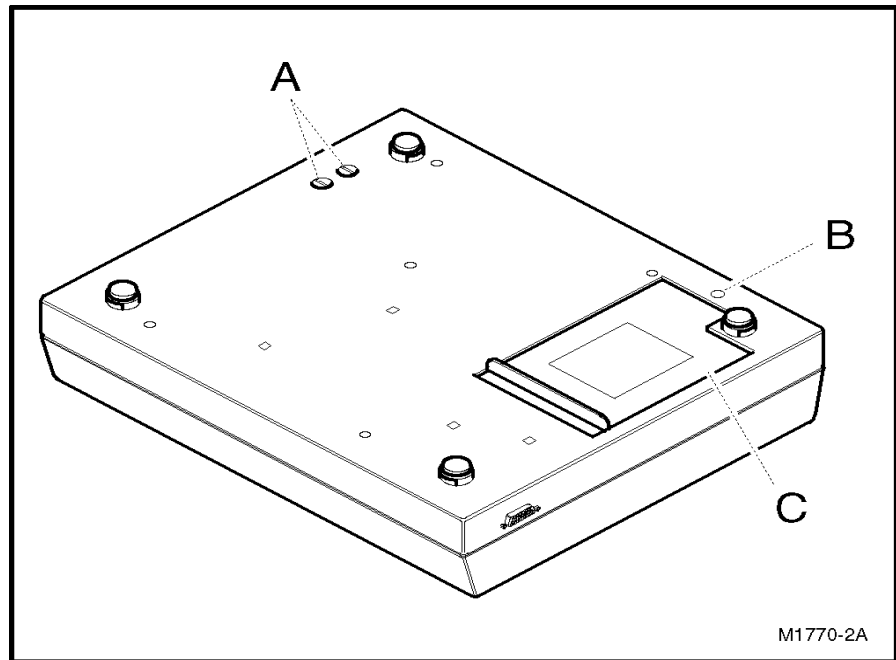

**Figure 1-2: Bottom View of Cardiograph**

- A. AC Fuse Holders with fuse replacement information
- B. Mounting Point for Optional M1705B Cart  
(Mounting screw included with cart)
- C. Battery Door with battery replacement information

---

## The Keyboard and Front Panel

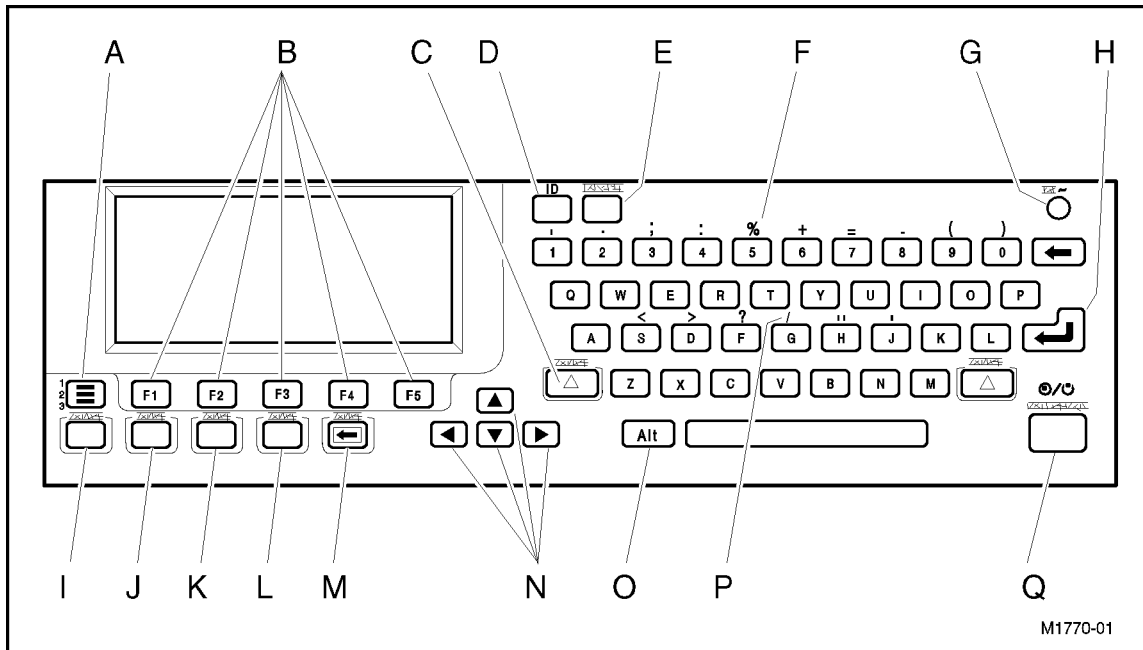













Figure 1-3: The Keyboard and Front Panel of the Cardiograph

- A  Displays the configuration **menu**, unless an ECG report is in-process. Use **Exit** , **Stop** , or  to return to the normal ECG display.
- B **softkey** These five keys (F1 – F5), located directly beneath the display window, perform different functions at different times. They are called “softkeys.” When a softkey is active, a label describing its function is displayed above it on the screen. Press the key to perform the function displayed on the screen.
- C **Shift** Used to enter shifted characters.
- D **ID** Allows patient identification entry, review, and edit.
- E **Filter** Turns filters on and off. The filter or filters controlled by this key are selected during cardiograph configuration.
- F **Shift-Char** Enters the upper case letters and punctuation marks shown above the number keys when you press the corresponding letter or number key while pressing the **Shift** key.
- G **AC** This indicator is lighted when the power cord is plugged into an active wall outlet. This also indicates that the battery is charging.
- H  The **Enter** key.
- I **Auto** This key starts an Auto ECG recording.
- J **Manual** Starts a Manual ECG recording. Also restores the ECG trace during a Manual report after defibrillation.
- K **Stop** Halts any cardiograph activity and restores the normal ECG display.
- L **Copy** Prints a copy of the last Auto ECG.
- M **Page** Advances the paper to the beginning of the next page.
- N  To view lead groups, use the  or  keys to move to the next lead group, and the  or  keys to move to the previous lead group. The  or  keys move the cursor down on configuration displays and patient ID information screens. The  and  keys move the cursor up.
- O **Alt** Used to enter alternate characters. (See item **P**.)
- P **Alt-Char** To enter the characters shown above the letter keys (see Table 1-1 for language-specific keys), press the **Alt** key with the desired letter.
- Q **On/Standby** Switches the cardiograph between **On** and **Standby**. Standby means the cardiograph is off, but charging the battery, when it is plugged in to AC power.



**Table 1-1: Characters by Language**

Key	English		French		German		Dutch		Italian		Spanish	
	alt	ALT	alt	ALT	alt	ALT	alt	ALT	alt	ALT	alt	ALT
a			à	à	ä	Ä	ä	Ä	à	à	á	A
b	#	}	#	}	#	}	#	}	#	}	#	}
c	@		@		@		@		@		@	
d	>	>	>	>	>	>	>	>	>	>	>	>
e			ê	ê			ë	ë			é	É
f	?	?	?	?	?	?	?	?	?	?	?	?
g	/	\	/	\	/	\	/	\	/	\	/	\
h	“	“	“	“	“	“	“	“	“	“	“	“
i			î	î					ì	ì	í	í
j	,	,	,	,	,	,	,	,	,	,	,	,
k									è	è		
l			ù	ù					é	É	ñ	Ñ
m	~	] ]	~	] ]	~	] ]	~	] ]	~	] ]	~	] ]
n	!	[ [	!	[ [	!	[ [	!	[ [	!	[ [	!	[ [
o			ô	ô	ö	Ö	ö	Ö	ò	ò	ó	ó
p			ç	Ç	ß	ß	f					
q			â	â								
s	<	<	<	<	<		<	<	<	<	<	
u			û	û	ü	Ü	ü	Ü	ù	ù	ú	
v	^	{ {	^	{ {	^	{ {	^	{ {	^	{ {		
w			é	É							o	o
x	*	*	*	*	*	*	*	*	*	*		
y			è	è			ÿ	ÿ			ü	Ü
z	&	\$	&	\$	&	\$	&	\$	&	\$	&	\$



Key	Norwegian		Swedish		Finnish		Polish		Portuguese		Key		Russian	
	alt	ALT	alt	ALT	alt	ALT	alt	ALT	alt	ALT			alt	ALT
a	å	Å	ä	Ä					à	À				
b	#	}	#	}	#	}	}	}						
c	@		@		@									
d	>	>	>	>	>	>			>	>				
e	æ	Æ							ê	Ê				
f	?	?	?	?	?	?	?	?	?	?				
g	/	/	/	/	/	/	/	/	/	/				
h	“	“	“	“	“	“			“	“				
i														
j	,	,	,	,	,	,			‘	’				
k														
l														
m	~	]	~	]	~	]								
n	!	[	!	[	!	[								
o	ø	Ø	ö	Ö	ö	Ö								
p							“	“	ú	Ú				
q			å	Å	å	Å			ã	Ã				
r									ê	Ê				
s	<	<	<	<	<	<			<	<				
t									ô	Ô				
u			ü	Ü	ü	Ü	>	>	ê	Ê				
v	^	{	^	{	^	{	{	{						
w					š	Š			õ	Õ				
x	*	*	*	*	*	*								
y							<	<	á	Á				
z	&	\$	&	\$	&	\$								

---

## About Your Cardiograph

Your PageWriter 200/300pi cardiograph:

- Acquires 12 leads simultaneously.
- Allows you to check lead quality on the preview screen before printing the ECG.
- Provides selectable formats (Auto and Manual).
- Reports measurements of the ECG.
- Operates on a rechargeable battery. AC power charges the battery.
- Has a digital array printer with continuous-feed paper.
- Has a 200 sheet Z-fold paper capacity.

In addition to the features listed above, the PageWriter 300pi cardiograph can analyze and interpret the ECG. The PageWriter 300pi also includes Predictive Instrument applications that detect Acute Myocardial Infarction and Acute Cardiac Ischemia, as well as calculate predicted outcome with and without thrombolytic therapy.

### Accessories

Your cardiograph was shipped with one of the following three accessory sets, according to your geographic option:

**No Electrodes Accessory Set — Options: ABB, ABD, ABE, ABF, ABH, ABS, ABU, ABX, ABZ, AKD, ACB, AC4, AB9, ABN**

- Battery assembly
- Power cord
- Patient Cable
- 1 package of paper
- PageWriter 200/300pi User's Guide
- *Using the HP PageWriter 200/200i Cardiograph* operator training video (also applicable to the PageWriter 300pi)
- Hewlett-Packard Interpretive Cardiograph Physician's Guide

For electrodes, contact your local Agilent Technologies Sales Office or your authorized Agilent Technologies Dealer or Distributor.

---

**Reusable Electrodes Accessory Set — Options: ABG, ABK, ABM, AB2, AB4, AKV, ABK, AKM, ACQ, AC6, ACJ**

- Battery assembly
- Power cord
- Patient Cable
- 1 package of paper
- 6 Welsh bulb electrodes
- 4 limb plate electrodes and straps
- PageWriter 200/300pi User's Guide
- *Using the HP PageWriter 200/200i Cardiograph* operator training video (also applicable to the PageWriter 300pi)
- Hewlett-Packard Interpretive Cardiograph Physician's Guide

**Disposable Electrodes Accessory Set — Options: ABA, ABC**

- Battery assembly
- Power cord
- Patient Cable
- 1 package of paper
- Disposable electrode starter set
- Tab electrode adapters
- PageWriter 200/300pi User's Guide
- *Using the HP PageWriter 200/200i Cardiograph* operator training video (also applicable to the PageWriter 300pi)
- Hewlett-Packard Interpretive Cardiograph Physician's Guide

**Options**

Your PageWriter 200/300pi cardiograph can store and transmit ECGs if you purchased Options #A05 or StressWriter. See ECG Storage (Options #A05 or StressWriter), for information about storing, retrieving and editing ECGs. See Transmitting, Faxing, and Receiving Auto ECGs (Options #A05 or StressWriter only), for information about sending ECGs to other PageWriter cardiographs or the TraceMaster ECG Management system.

---

## Patient and Operational Safety Notes

Your cardiograph isolates all connections to the patient from electrical ground and all other conductive circuits in the cardiograph. This reduces the possibility of hazardous currents passing from the cardiograph through the patient's heart to ground. To ensure the patient's safety and your own, observe the following reminders:

- When operating your cardiograph from AC power, be sure it and all other electrical equipment connected to or near the patient are effectively grounded.
- Use only grounded power cords (three-wire power cords with grounded plugs). Also make sure the outlet accepts the plug and is grounded. *Never* adapt a grounded plug to fit an ungrounded outlet by removing the ground prong or ground clip. Should an ungrounded plug adapter be necessary, use a ground strap to connect the equipotential connector at the rear of the instrument to the power source ground.
- The patient cable should be routed away from power cords and any other electrical equipment. Failure to do so can result in AC power line frequency interference on the ECG trace.

---

### WARNING

---

**The patient cable supplied with this cardiograph, or an Agilent Technologies approved substitute patient cable, is an integral part of the cardiograph's safety features. Using any other patient cable may compromise defibrillation protection as well as cardiograph performance.**

**Only qualified personnel may service the cardiograph.**

---

---

### WARNING

---

**Do not use this cardiograph near flammable anesthetics. It is not intended for use in explosive environments.**

**Do not touch the patient, patient cable or cardiograph during defibrillation. Death or injury may occur from the electrical shock delivered by the defibrillator.**

**Be sure that the electrodes or lead wire tips do not come in contact with any other conductive materials, including earth-grounded materials, especially when**

**connecting or disconnecting electrodes to/from a patient.**

**The use of multiple instruments connected to the same patient may pose a safety hazard due to the summation of leakage currents from each instrument. Any combination of instruments should be evaluated by local safety personnel before being put into service.**

**Do not pull on the paper while a report is being printed. This can cause distortion of the waveform and can lead to potential misdiagnosis.**

---

**WARNING**

---

**(#A05 or StressWriter Options only) Equipment connected to the cardiograph's RS-232 connector can cause ground leakage currents exceeding the maximum specified in IEC601-1 safety standards.**

**Do not connect any equipment to the RS-232 connector during cardiograph operation unless you can verify that the leakage current is within the specified limits.**

---



---

**CAUTION**

---

**Do not block the ventilation slots. Lack of ventilation may cause the cardiograph to overheat, resulting in failure of internal electronic components.**

---



---

**NOTE**

---

**The Agilent Technologies warranty is only assured if you use Agilent Technologies approved accessories and replacement parts. See Maintaining the Cardiograph for more information.**

---



---

## **Electromagnetic Compatibility**

When using the PageWriter 200/300pi, electromagnetic compatibility with surrounding devices should be assessed.

A medical device can either generate or receive electromagnetic interference. Testing for electromagnetic compatibility (EMC) of the PageWriter 200/300pi cardiograph has been performed according to IEC 601-1-2. This IEC standard has been adopted in Europe as the European Norm (EN 60601-1-2).

This EMC standard describes tests for both emitted and received interference. Emission tests deal with interference generated by the device being tested.

Tests for the 200/300pi cardiographs show they do not emit interference that exceeds the IEC 601-1-2 limits.

---

## Reducing Electromagnetic Interference

The M1770/M1771 PageWriter 200/300pi cardiographs are susceptible to interference from other RF energy sources and continuous, repetitive, power line bursts. Examples of other sources of RF interference are medical devices, cellular products, information technology equipment and radio/television transmission. Should interference be encountered, as demonstrated by artifact on the ECG, attempt to locate the source. Assess:

- Is the interference intermittent or constant?
- Does the interference occur only in certain locations?
- Does the interference occur only when in close proximity to certain medical devices?

Once the source is located, attempt to attenuate the EMC coupling path by distancing the cardiograph from the source as much as possible. If assistance is needed, call your local Agilent Technologies service representative.

---

## Restrictions for Use

Artifact on the ECG caused by electromagnetic interference should be evaluated by a physician or physician authorized personnel to determine if it will negatively impact patient diagnosis or treatment.

---

## AC and Battery Operation

The battery must be installed for proper operation of the cardiograph—even if the cardiograph is plugged into AC power, it cannot print an ECG report without the battery. For information about replacing or installing the battery, refer to Setting Up Your Cardiograph.

The following is a list of AC and battery operating information:

- A fully charged battery (without AC power) will print approximately 40 Auto ECGs, or approximately 40 minutes of **continuous** Manual ECG information.

- The **Low Battery** message on the display indicates the battery needs to be charged.
- From the time the **Low Battery** message is first displayed to when the cardiograph automatically is turned to **Standby** (off), there is typically enough reserve battery capacity to record two Auto ECGs or 2-minutes of Manual ECG data. A weak or faulty battery will reduce this time.
- The flashing **Low Battery** message indicates that the cardiograph will turn itself off in one minute unless it is plugged into AC power.
- A discharged battery requires at least 5 minutes charging time, with the cardiograph in **Standby** (off), before printing an Auto ECG.
- A discharged battery requires at least 10 minutes charging time, with the cardiograph in **Standby** (off), before printing a 1-minute Manual ECG.

**NOTE**

If the cardiograph is turned on while the battery is being charged, these charging times are doubled (10 minutes for an Auto ECG and 20 minutes for a 1-minute Manual ECG).

- The PageWriter 200/300pi cardiograph has a battery-saving feature: it will turn itself to **Standby** (off) after 30 minutes of instrument inactivity. This prevents the cardiograph from being accidentally left on for extended periods of time.

**NOTE**

This feature is **not** active if all the limb electrodes are connected to a patient or if the cardiograph is plugged into AC power.

- A new battery or a battery that has been stored for an extended period of time requires charging (with the cardiograph in **Standby** (off)) for 16 hours in order to guarantee a full charge.
- The battery, if installed, is being charged any time the AC light is on.
- A fully depleted battery will charge to 90% of full capacity in 7 hours, and 100% capacity in 16 hours, as long as the cardiograph is in **Standby** (off) for the entire time.
- When the cardiograph is not in use, it should be connected to AC power and left in **Standby** (off). This will maintain a full battery charge and prolong battery life.



---

**NOTE**

---

The cardiograph's battery charging circuit delivers less power than the cardiograph uses while printing an ECG. It is possible to run down the battery, even when the cardiograph is plugged into AC power, if the printer is being heavily used.

---

## 2 Recording an ECG

This chapter describes how to:

- prepare the patient for an ECG
- check the signal quality of the patient leads
- enter patient ID and printed report information
- record an ECG
- change the report format
- understand the printed report

Samples of the different Manual and Auto ECG formats are also shown.

---

**NOTE**

---

---

If the cardiograph has not been setup, refer to *Setting Up Your Cardiograph*, for instructions.

---

If your cardiograph is already configured, you can record an ECG by performing the following steps and procedures. (If you need to configure your cardiograph or check settings, refer to *Configuring Your Cardiograph*.)

1. If the cardiograph is not **On**, press **On/Standby**.
2. Prepare the patient and apply the electrodes, as described in the next section, “Preparing the Patient”.
3. Check the signal quality on all leads, as described in “Checking Signal Quality”, later in this chapter.
4. Enter patient ID information, if necessary. This is described in “Entering Patient ID”, later in this chapter.
5. Press **Auto** to record a 12-lead ECG, or press **Manual** to record a rhythm report.

The rest of this chapter discusses the details of setting up and recording ECGs.

---

## Preparing the Patient

For electrode placement information, refer to the diagram on the top of your cardiograph.

---

### NOTE

---

Proper patient preparation and electrode placement are the most important elements in producing a high quality ECG trace.

Prepare the patient by performing the following steps.

1. Reassure and relax the patient. A calm and quiet patient produces the best ECGs.
2. Make sure the electrode site is not covered by hair or clothing.
3. Gently clean and abrade the surface of the skin with dry gauze.
4. Place electrodes on patient. See the following notes regarding your type of electrodes.
5. Attach each lead wire to the correct electrode.
6. The upper-left corner of the screen displays the electrodes that are not placed firmly on the patient and/or the lead wires that are not attached securely to the electrodes. (See Table 2-1.) This is an indication of “**leads off**”. Correct the attachment of any lead/electrode pair that appears on the screen.

---

### NOTE

---

The patient cable should be routed away from power cords and any other electrical equipment. Failure to do so can result in AC line frequency interference on the ECG trace.

---

**Table 2-1: Leads Off Labels**

Designator (AHA/IEC)	Meaning
RL/N	Right leg electrode not connected <b>or</b> only right leg electrode is connected and all other limb electrodes are not connected.
RA/R	Right arm electrode is not connected.
LA/L	Left arm electrode is not connected.
LL/F	Left leg electrode is not connected.
V1...V6/ C1...C6	One or more chest electrodes are not connected. For example, V2 means the V2 electrode is not connected.

**Notes for Customers Using Reusable Electrodes**

Each electrode must be attached securely. Straps must neither slide nor be so tight as to cause discomfort.

The electrode paste, gel, or creme must cover an area the size of the electrode, but must not extend beyond it, especially on the chest.

**Notes for Customer Using Disposable Tab Electrodes**

Disposable electrodes have conductive material on the adhesive side only. The electrode tab must be placed between the jaws of the electrode adapter clip, and remain flat. Do not attempt to place the jaws of the electrode adapter so close to the circular part of the electrode that the tab of the electrode is bent, or contact is made with the conductive gel. Gently tug on the electrode adapter to ensure that the electrode adapter is properly placed on the electrode.

Good and accurate placement on the first attempt should be your goal for each electrode. Each time an electrode is lifted off the skin and attached again, the adhesive gel becomes weaker and less effective.

**NOTE**

Never mix reusable and disposable electrodes on the same patient.

---

## Understanding When a Signal is Acquired

Your PageWriter 200/300pi cardiograph attempts to acquire a good signal for an Auto report before you press the **Auto** key. This is called pre-acquisition. Pre-acquisition is activated when the cardiograph is turned on and remains active until an Auto report begins to print. Pre-acquisition is also suspended whenever an electrode is disconnected.

Pre-acquisition is reactivated when a patient ID is entered or edited, or when a Manual report is finished printing.

When Pre-acquisition is active, it is important for the patient to stay still and relaxed. This will help ensure a good signal is captured prior to printing an Auto report.

---

**NOTE**

Pre-acquisition is not used for Manual ECG reports.

---

---

## Performing a Stat ECG (Bypassing Patient ID Entry)

Perform the following step when an ECG is needed quickly.

1. If the cardiograph is not **On**, press **On/Standby**.
2. Prepare the patient and apply the electrodes.
3. Do one of the following:
  - A. Press **Manual** twice for a Manual ECG report.
  - B. Press **Auto** twice for an Auto ECG report.

---

**NOTE**

Reports printed by following the above steps will use the last patient identification information even if powered off in between. Be sure the patient ID data on the report matches the patient.

---

---

**NOTE**

Signals seen on the screen can only be captured for an Auto report when Pre-acquisition is active. See “Understanding When a Signal is Acquired” for more information on Pre-acquisition.

---

## Checking Signal Quality





You can produce better ECGs by previewing the lead traces on the screen before you record and print the ECG. By observing the traces and adjusting the leads accordingly, you can make the best possible ECG recording.

The screen displays the output from the selected three leads whenever the cardiograph is on.

The leads are displayed in five groups of three leads each. The groups are listed below:

**Table 2-2: Lead Groups**

Group	Leads Displayed
Group 1	I, II, III
Group 2	aVR, aVL, aVF
Group 3	V1, V2, V3
Group 4	V4, V5, V6
Group 5	Custom 3

- To select which three leads to display on the screen, press the  or  key, or the `Space` bar, to display the next lead group, or press the  or  key to display the previous lead group.
- Before you connect the electrodes, each lead displays on the screen as a dotted line, indicating that at least one of the electrodes associated with the lead is not connected. **The dotted line is known as a “leads off” trace.** Use the leads off labels (see Table 2-1) to determine which leads are off.
- As you connect the electrodes to the patient, the lead waveforms are displayed on the screen.

---

**NOTE**

The ECG traces are updated by the erase bar that moves across the screen.

---

---

## Entering Patient ID

Entering patient ID information is not required to record an ECG. Note that for the PageWriter 300pi, some ID fields affect the interpretation of Auto ECGs and this ID information should therefore be entered. See “Understanding ECG Analysis and the Predictive Instruments Applications” for more information.

---

**NOTE**

If the cardiograph is configured to record no ID information, pressing  displays the following message:

**ID entry has been disabled  
Change your configuration to  
enter ID data.**

**Press any key to continue.**

---

The following steps detail one of two methods of entering patient ID information. See “Recording an Auto ECG” or “Recording a Manual ECG” later in this chapter for the second method.

To enter patient identification, perform the following steps (these steps assume all ID fields are enabled).

1. Press . If there is an existing patient ID in the cardiograph, the question `New patient?` is displayed. If not, the patient ID entry screen is displayed. You can press  at any time to return to the ECG display.
  - A. If you press **Yes, Enter New ID** to answer the `New patient?` query, the existing patient ID information is cleared and the patient ID entry screen is displayed.

- B. If you press **No, Edit Old ID** to answer the `New patient?` query, the existing patient ID information is displayed for you to review or change, if necessary.
2. Type the patient ID number and press , , or . The next line requests the patient's name.
  3. Type the patient's name and press the , , or . The next line requests the patient's age. It also allows you to change the age designation (Years, Year of Birth, Months, Weeks, Days, or Hours).
  4. Type the patient's age. Press **Change** until the screen displays the age designation you want to use. Press  or .

There are more patient ID fields into which you can enter patient information. All of the patient information fields are shown in Table 2-3. Note that some (or all) of these fields may be inactive for your configuration.

Each time you press the  or , the information you entered is recorded and the cursor moves down to the next ID field. To return to a previous field, move the cursor up by pressing  or .

To change or erase data you have entered, simply type over the existing data, or use the  key to delete the character to the left of the cursor or press **Erase**, if available.

You can stop entering patient ID information at any time by pressing **Exit** (or ). This saves all the field entries in the patient ID record, including the information you just entered.

---

**NOTE**

---

To start recording an ECG more quickly, you can press  or  instead of **Exit** or . This saves all the patient ID information you just entered and starts an ECG recording all at the same time.

---



## Reviewing and Changing Patient ID

To review and change the current patient ID information:

1. Press the **ID** key. The message **New Patient?** displays.
2. Press **No, Edit Old ID**. The current patient ID screen displays, and you can change any field.

---

**NOTE**

---

To enter information more quickly, you can suppress the display of unused ID fields. Refer to *Configuring Your Cardiograph* for details.

---

**Table 2-3: Patient ID Fields**

Prompt	Comments	Entry	# of char.
ID:	Type the patient ID number.	Alphanumeric	16
Name:	Type the patient name.	Alphanumeric	30
Age:	Type the patient age. Press <b>Change</b> to select the age designation: Years Year of Birth Months Weeks Days Hours	Numeric	4
Sex:	Press <b>Change</b> to select Male or Female.		

**Table 2-3: Patient ID Fields**

Prompt	Comments	Entry	# of char.
Chest/LA pain entry?	Blank Yes, Chief Complaint Yes, Secondary Complaint No Chest/Left Arm Pain	3 character field	
Acute Ischemic Sx time Entry?	Type the time in minutes.	3 character field	
History Diabetes Entry?	Yes or <b>No</b>	3 character field	
History Hypertension Entry?	Yes or <b>No</b>	3 character field	
Height:	Type the height.	Numeric	3
Weight:	Type the weight.	Numeric	3
Blood Pressure:	Type the systolic value, then press <input type="checkbox"/> . Type the diastolic value.	Numeric	3
Operator:	Type the cardiograph operator's initials or number.	Alphanumeric	4
Department:	Type the department number where the ECG is recorded.	Alphanumeric	8
Room:	Type the patient room name or number.	Alphanumeric	8



**Table 2-3: Patient ID Fields**

Prompt	Comments	Entry	# of char.
Requested by:	Type name or number of the person requesting the ECG.	Alphanumeric	16
Custom Field One:	This label can be configured as needed. See Table B-1.	Alphanumeric	16
Custom Field Two:	This label can be configured as needed. See Table B-1.	Alphanumeric	16
Set ECG Mgmt Priority to Stat?	<b>Yes</b> or <b>No</b>	Setup ID entry for ECG management system priority to indicate a 'STAT' ECG. Only applies to cardiographs with storage and transmission.	3

---

## Recording a Manual ECG

To record a Manual ECG, perform the following steps.

1. If the cardiograph is not **On**, press **On/Standby**.
2. Prepare the patient and apply the electrodes.
3. Check the signal quality on all leads.
4. Enter patient ID information, if necessary.
5. Press **Manual** on the front panel.
  - If you did not enter a patient ID in the above step and have **not** entered a patient ID since turning on the cardiograph, the message No

ID, Continue? is displayed. Press **Yes** to record the ECG without a patient ID. Press **No, Enter ID** to enter patient ID information.

- If you did not enter a patient ID in the above step but have entered patient ID information since the cardiograph was turned on, the question Continue using Old ID? is displayed. If you have entered a patient identification number and want to take more ECGs from the same patient, press **Yes**.

If you are recording an ECG from another patient, press **No, Edit Old ID** or **No, Enter New ID**.

**NOTE**

Your cardiograph automatically checks for a patient ID each time you start an ECG, unless it is configured for no patient ID information. To bypass this check and use the last entered patient ID, press **Manual** a second time.

6. The cardiograph prints the ECG continuously until you press the **Stop** key.

**NOTE**

If accurate ECG ST contours are required for ECGs recorded in Manual mode, do not use the 0.5 Hz baseline wander filter. This filter suppresses baseline wander to the extent that it may alter the ST segment. Instead, configure your cardiograph to use the 0.15 Hz or 0.05 Hz baseline wander filter. Regardless of the filter used, the rhythm characteristics of the ECG are accurately recorded. Refer to Configuring Your Cardiograph for details on configuring filters.

The leads recorded by the manual ECG, the chart speed, sensitivity, and filter status can be changed at any time, even while a manual ECG is running. To change these settings simply select **Format**, **Leads**, **Speed**, **Size**, or **Filter** keys, as appropriate. Note, however, that the ECG printer will pause as the cardiograph changes its recording status.

- The **Format** key sequence is: 3 ⇒ 6 ⇒ 12 ⇒ 3 ...

- The **Leads** key sequence is:  
**3 lead manual** - Custom ⇒ I II III ⇒ aVR, aVL, aVF ⇒ V1 V2 V3 ⇒ V4 V5 V6 ⇒ Custom ...  
**6 lead manual** - Custom Leads ⇒ Limb Leads ⇒ V1–V6 Leads ⇒ Custom Leads ...
- The **Speed** key sequence is: 25 ⇒ 50 ⇒ 5 ⇒ 10 ⇒ 25 ... (numbers indicate chart speed in mm/sec).
- The **Size** key sequence is: 1.0 ⇒ 1.0 ½V ⇒ 2.0 ⇒ 2.0 ½V ⇒ 0.5 ⇒ 0.5 ½V ⇒ 1.0 ...
- The **Filter** key sequence is an On/Off toggle. When **Filter** is active, **Filter** is displayed on the screen.

---

## Restoring the ECG Trace After Defibrillation or Reconnecting Leads

After application of a defibrillator pulse, reconnecting one or more leads, or any other time the ECG signal is off-center during a Manual report, the trace can be quickly restored by pressing the **Manual** key.

---

## Recording an Auto ECG

To record an Auto ECG, perform the following steps.

1. If the cardiograph is not **On**, press **On/Standby**.
2. Prepare the patient and apply the electrodes.
3. Check the signal quality on all leads.
4. Enter patient ID information, if necessary.
5. The leads recorded by the Auto ECG, the chart speed, sensitivity, and filter status can be changed before the Auto ECG starts. To change these settings simply select **Format**, **Leads**, **Speed**, **Size**, or **Filter** keys, as appropriate.
  - The **Format** key sequence is: 3x4 ⇒ 3x4 1R ⇒ 3x4 3R ⇒ 6x2 ⇒ 3x4 ...

- The **Leads** key sequence is:  
**3x4 1R:** I ⇒ II ⇒ III ⇒ aVR ⇒ aVL ⇒ aVF ⇒ V1 ⇒ V2 ⇒ V3 ⇒ V4 ⇒ V5 ⇒ V6 ⇒ I ...  
**3x4 3R:** Custom Leads ⇒ I, II, III ⇒ aVR, aVL, aVF ⇒ V1, V2, V3 ⇒ V4, V5, V6 ⇒ Custom Leads ...
  - The **Speed** key sequence is: 25 ⇒ 50 ⇒ 25 ...(numbers indicate chart speed in mm/sec).
  - The **Size** key sequence is: 1.0 ⇒ 1.0 ½V ⇒ 2.0 ⇒ 2.0 ½V ⇒ 0.5 ⇒ 0.5 ½V ⇒ 1.0 ...
  - The **Filter** key sequence is an On/Off toggle. When **Filter** is active, **Filter** is displayed on the screen.
6. Press **Auto** on the front panel.
- If you did not enter a patient ID in the above step and have not entered a patient ID since turning on the cardiograph, the message **No ID, Continue?** is displayed. Press **Yes** to record the ECG without a patient ID. Press **No, Enter ID** to enter patient ID information.
  - If you did not enter a patient ID in the above step but **have** entered patient ID information since the cardiograph was turned on, the question **Continue using Old ID?** is displayed.
- If you have entered a patient identification number and want to take more ECGs from the same patient, press **Yes**.
- If you are recording an ECG from another patient, press **No, Edit Old ID** or **No, Enter New ID**.

**NOTE**

Your cardiograph automatically checks for a patient ID each time you start an ECG, unless it is configured for no patient ID information. To bypass this check and use the last entered patient ID information, press **Auto** a second time.

7. The status messages **Acquiring ECG...**, **Processing...**, **Analyzing...** and **Printing...** are displayed.

---

## Making Copies of Auto ECGs

If you require additional copies of an Auto ECG, you may print a copy of the last ECG that was recorded. See Figures 2-1 through 2-6 for examples of the report formats available.

To print a copy of your most recent Auto ECG, press the **Copy** key. The message `Printing . . .` is displayed and the copy is printed.

To print a copy of the extended measurements report for the most recent ECG, press the **Shift** and **Copy** keys at the same time. The extended measurements report summarizes the morphology and rhythm characteristics for the individual lead waveforms and rhythm groups in the ECG. The PageWriter 300pi uses these measurements to suggest an interpretation. See Figure 3-3 and Figure 3-5 in “Understanding ECG Analysis and the Predictive Instruments Applications” for examples of the extended measurements report.

---

### NOTE

Unless you save the ECG, you must print an additional copy before the cardiograph has been turned to **Standby** (off), before another ECG has been acquired, before changing the ID, and before changing the cardiograph configuration.

You may print copies of a stored ECG at any time. See `Printing Stored ECGs` in `ECG Storage (Options #A05 or StressWriter)`, for more information.

You may change the format and corresponding leads, and speed (25 or 50 mm/sec) prior to printing a copy of an ECG.

You can only print copies of Auto ECGs.

Copies of ECGs use the copy interpretation format specified when the cardiograph was configured. See the section titled `Miscellaneous Report Fields` in `Configuring Your Cardiograph`.

---

---

## Understanding the Printed Report

The PageWriter 200/300pi provides Auto, Manual, and Extended Measurements reports. This section describes the Manual and Auto reports. The Manual report features closely resemble those of the Auto report. The Extended Measurements report is described in “Understanding ECG Analysis and the Predictive Instruments Applications”.

---

## Choosing a Report Format

An Auto report prints a one- or two-page summary of all 12 cardiograph leads. (More pages may be needed to print additional interpretation statements. See Table 2-4). A Manual report prints continuously until the **Stop** key is pressed. The Auto and Manual report formats are available for both standard and Cabrera leads. The Cabrera lead order is an alternative limb lead order in which aVR is inverted and shown as -aVR. Lead order is aVL, I, -aVR, II, aVF, III, V1 through V6. The Cabrera lead order makes it easier to visualize waveform progression in the frontal plane.

Using the softkeys below the cardiograph’s display, the user can select the desired report format and lead configuration. To change to a different report format, see “Changing the Report Format” later in this section.

**Table 2-4: Auto Report Length Configurations**

Model	Number of pages in Auto report	
	At 25 mm/sec	At 50 mm/sec
300pi with Interpretation off	1	2
300pi with interpretation on	1 or more	2 or more
200	1	2



## Changing the Report Format

To change the report format:

1. Press **Stop**. The bottom of the display will be similar to the one shown below.

Auto Report	3x4,3R Format	I,II,III Leads	25mm/s Speed	1.0 Size
-------------	---------------	----------------	--------------	----------

2. Press **Report** to select between Auto or Manual report menus. Note that the data displayed above the **Format** and **Leads** softkeys will change as you switch between the Auto and Manual report formats.
3. Press **Format** to select the report presentation. The selections are:
  - **Auto Formats:** 3x4, 3x4 1R, 3x4 3R, 6x2
  - **Manual Formats:** 3, 6, 12
4. Press **Lead** or **Leads**, if available for your format, to select the leads you wish to record.

### Auto Report Formats

12-lead Auto reports may be displayed in 3x4 or 6x2 formats. The 6x2 format displays longer segments of waveform information than the 3x4 format. Rhythm strips may be added to the 3x4 format to display longer ECG segments from one (or three) leads. For the 3x4 1R and 3x4 3R formats, the rhythm lead(s) may be configured to be any one (or three) of the 12 available leads. Refer to Figures 2-1 through 2-6 for examples of these Auto report formats.

### Manual Report Formats

Manual ECGs run continuously, from the time you press **Manual** until you press **Stop**. The cardiograph can be configured to display Manual reports with either 3, 6, or 12 leads. Manual ECGs reflect the ECG waveform as it occurs with a small delay.

Other lead groups can be selected while recording an ECG, and custom lead groups can also be selected. (See Power-On Report Fields in Configuring Your Cardiograph for information about setting up custom lead combinations for Manual ECG reports.) Refer to Figures 2-7, 2-8, and 2-9 for examples of these Manual report formats.

The following tables show the standard and default-custom lead configurations.

**Table 2-5: Manual Report Standard Formats**

Number of Leads	Standard Lead Choices	Default Custom Lead Choices
3	I, II, III aVR, L, F (aVR, aVL, aVF) V1, V2, V3 V4, V5, V6	II, aVF, V2
6	Limb (I, II, III, aVR, aVL, aVF) V1–V6 (V1, V2, V3, V4, V5, V6)	II, aVF, V2, III, V1, I
12	I, II, III, aVR, aVL, aVF, V1, V2, V3, V4, V5, V6	

**Table 2-6: Manual Report Cabrera Formats**

Number of Leads	Standard Lead Choices	Default Custom Lead Choices
3	aVL, I, -aVR II, aVF, III V1, V2, V3 V4, V5, V6	II, aVF, V2
6	Limb (aVL, I, -aVR, II, aVF, III) V1–V6 (V1, V2, V3, V4, V5, V6)	II, aVF, V2, III, V1, I



**Table 2-6: Manual Report Cabrera Formats**

Number of Leads	Standard Lead Choices	Default Custom Lead Choices
12	aVL, I, -aVR, II, aVF, III, V1, V2, V3, V4, V5, V6	

**Predictive Instrument Auto Report Formats**

For PageWriter 300pi models, select the type of Auto report interpretation and analysis as follows:

- 1 Press **Report** until 'Auto Analysis' (F1) key appears.
- 2 Press (F3) key to select the type of interpretation and analysis report.

The report options are described in Table 2-7:

**Table 2-7: Predictive Instrument Auto Report Options**

Auto Interpretation Selection	Report Produced
Adult	09 report - TPI and ACI TIPI disabled
Pediatric	P4 report - TPI and ACI TIPI disabled
ACI-TIPI	T0 report - ACI TIPI only, TPI disabled
TPI	H0 report - TPI only, no AMI screening, ACI TIPI disabled
Default	09 or P4 report - with configured settings

**NOTE**

To produce a T8 report, ACI-TIPI and 08 adult criteria, refer to Table A-2 in "Setting Up Your Cardiograph"

For additional information on the Predictive Instruments and associated reports, refer to “Understanding ECG Analysis and the Predictive Instruments Applications” and the *Predictive Instruments Physician’s Guide*.

## The Auto ECG Report

Figure 2-1: The Auto ECG Report

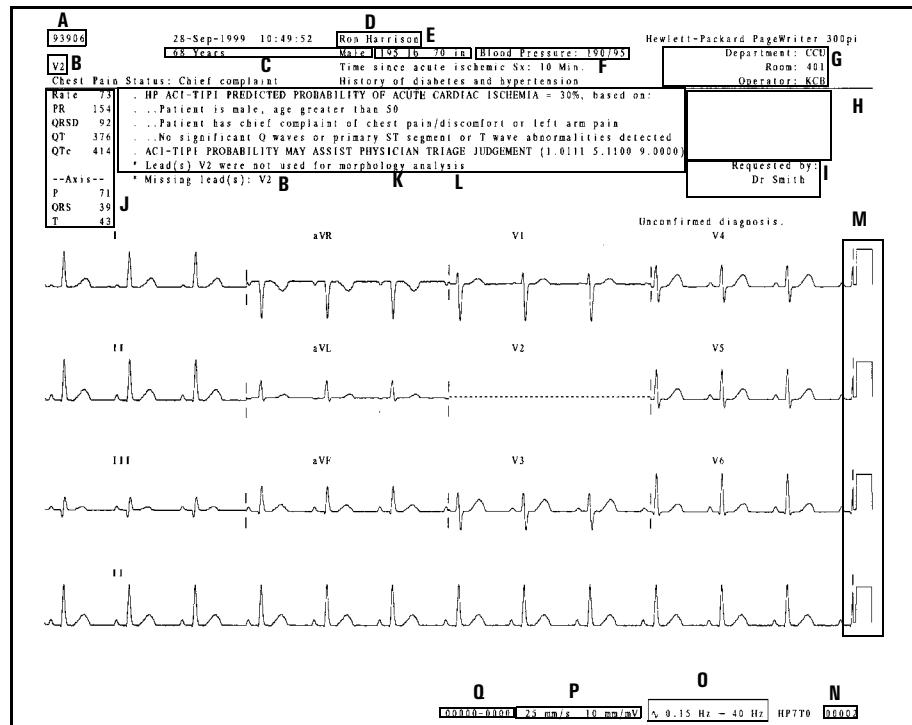

**Table 2-8: Auto Report Annotations**

	Description
A	Patient ID number
B	Leads Off Status
C	Age and Sex
D	Patient Name
E	Weight Height
F	Systolic/Diastolic Blood Pressure (BP)
G	Department Room No. Operator
H	Custom Field One Custom Field Two Note: These fields are for user-defined labels, such as insurance number or medications.
I	Requested by: the name of the requesting physician
J	Basic measurements
K	Interpretation (300pi)
L	Reasons (300pi)
M	Calibration signal. See Table 2-10.
N	Sequence number—the total number of ECGs recorded over the life of the cardiograph.
O	Filter settings: * Artifact filter (F) * AC filter( $\sim$ ) * Frequency response * Baseline Wander filter (W)

**Table 2-8: Auto Report Annotations**

	Description
P	Cardiograph settings for speed, and for limb and chest lead sensitivity.
Q	Location code and cardiograph ID number (Options #A05 or StressWriter only)

**Basic Measurements**

The basic measurements table gives standard interval and duration measurements in milliseconds, and limb lead axis measurements in degrees. These are representative values for the dominant beat pattern in the ECG. For more information on how representative beat measurements are derived, refer to “How the PageWriter 200/300pi Measures ECGs” in “Understanding ECG Analysis and the Predictive Instruments Applications”.

**Table 2-9: Basic Measurements**

Item	Description	Units
RATE	Heart rate	beats per minute
PR	PR interval	milliseconds
QRS	QRS duration	milliseconds
QT	QT interval	milliseconds
QT <sub>C</sub>	QT interval corrected for rate	milliseconds
P	Frontal P axis	degrees
QRS	Frontal mean QRS axis	degrees
T	Frontal T axis	degrees

**Calibration Signals**

The following table shows how the height of the calibration pulse indicates ECG sensitivity. Note that the display indicates sensitivity as:

## Choosing a Report Format

- 1.0 (normal or 10 mm/mV),
- 1.0 ½V (normal for leads other than V-leads, half-normal or 5 mm/mV for V-leads),
- 0.5 (half-normal or 5 mm/mV),
- 0.5 ½V (half-normal for leads other than V-leads, quarter-normal for V-leads),
- 2.0 (twice-normal or 20 mm/mV), or
- 2.0 ½V (twice-normal for leads other than V-leads, normal for V-leads).

**Table 2-10: Calibration Signals**

Display Label	ECG Size (mm/mV)		Calibration Pulse		
	Limb Leads	V-leads V1 - V6	Auto	Manual	
				Limb Leads	V-leads
0.5	5	5			
0.5 ½V	5	2.5			
1.0	10	10			
1.0 ½V	10	5			
2.0	20	20			
2.0 ½V	20	10			

## Auto Report Examples

The following figures show examples of Auto ECG report formats.

**Figure 2-2: A Standard Auto 3x4 ECG (3x4)**

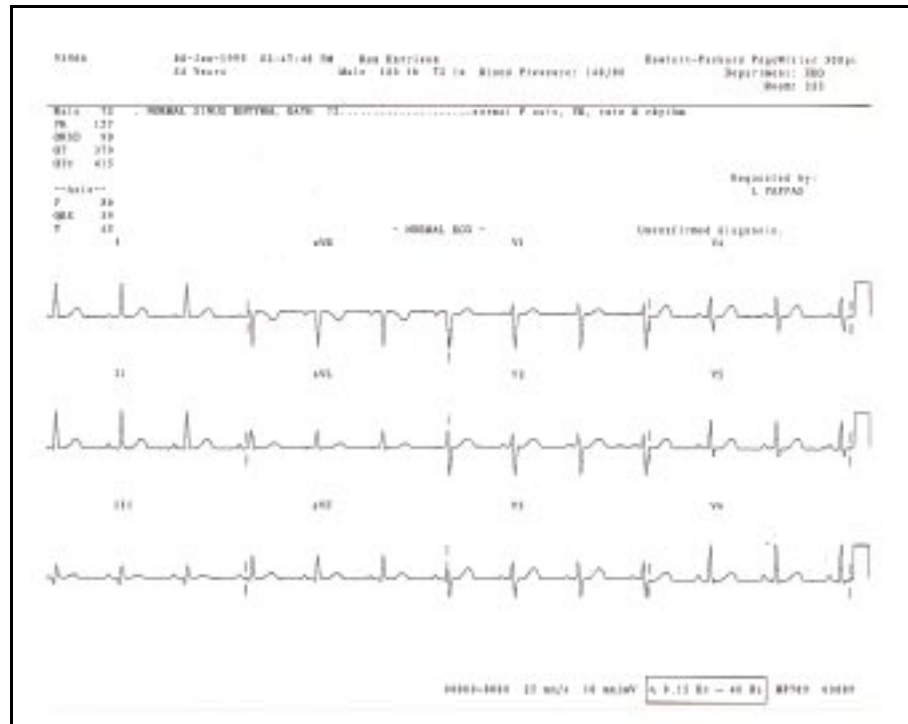

2



**Figure 2-3: An Auto 3x4 ECG with One Rhythm Strip (3x4, 1R)**

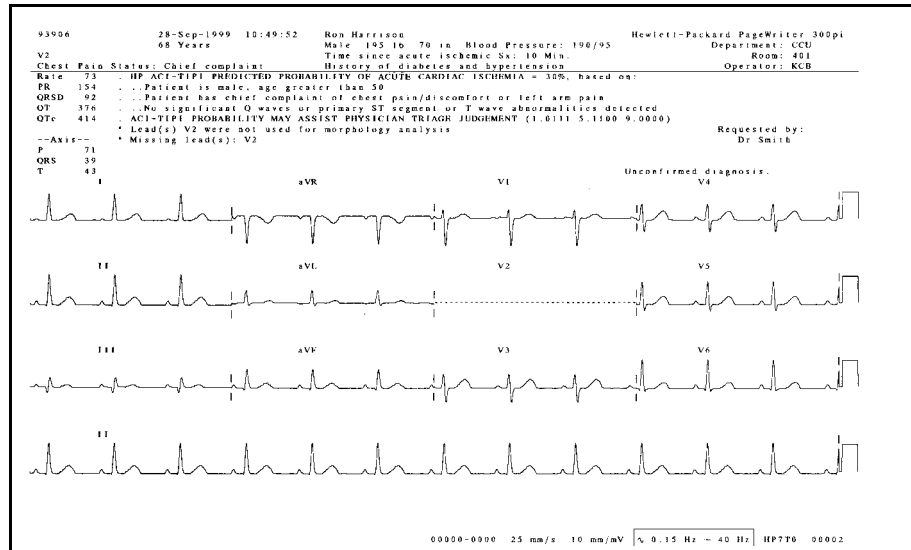

**Figure 2-4: An Auto 3x4 ECG with Three Rhythm Strips (3x4, 3R)**

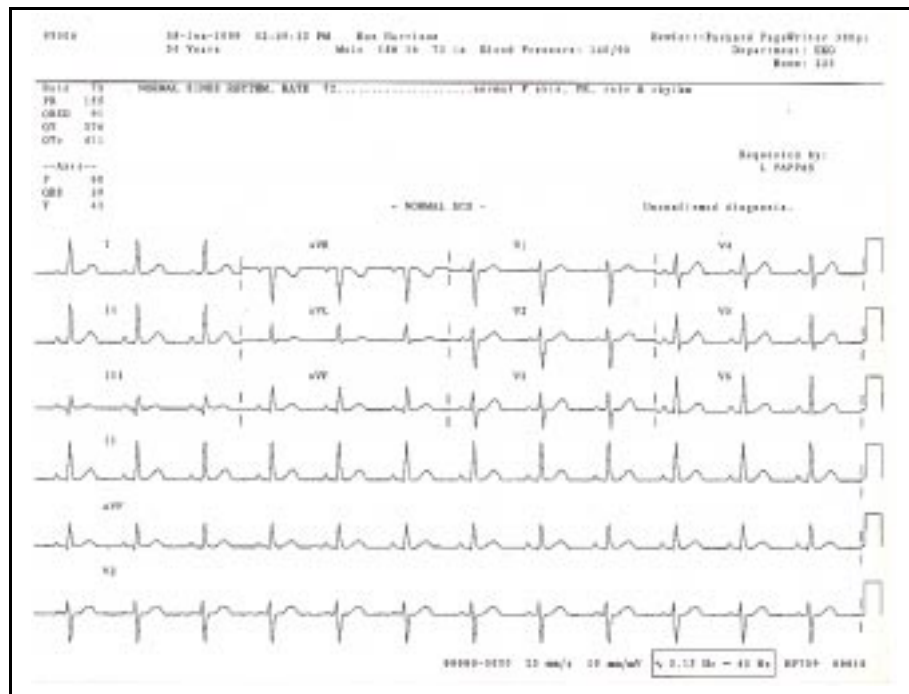
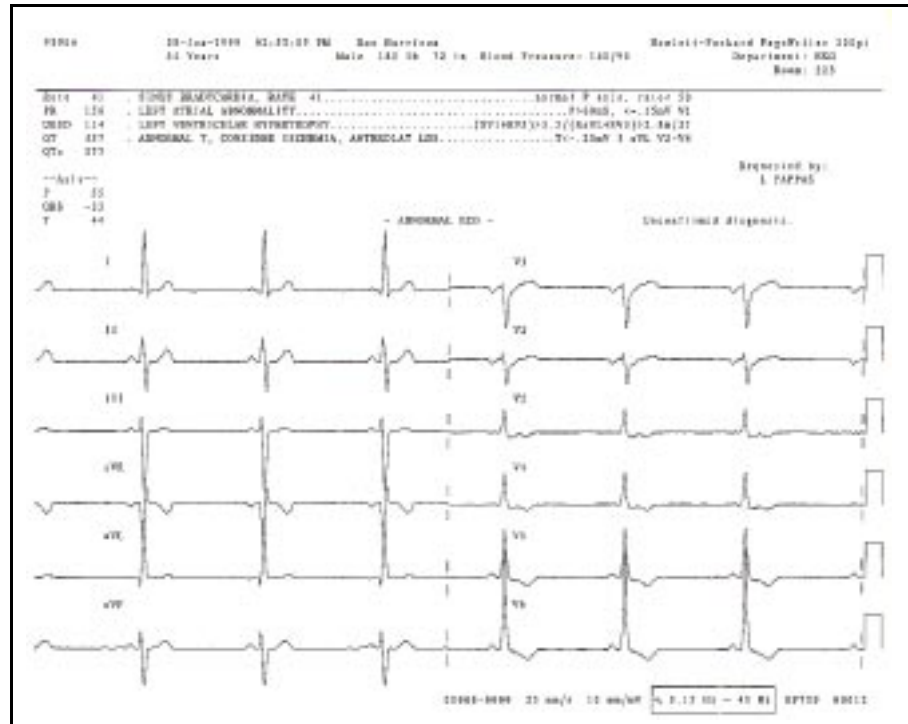
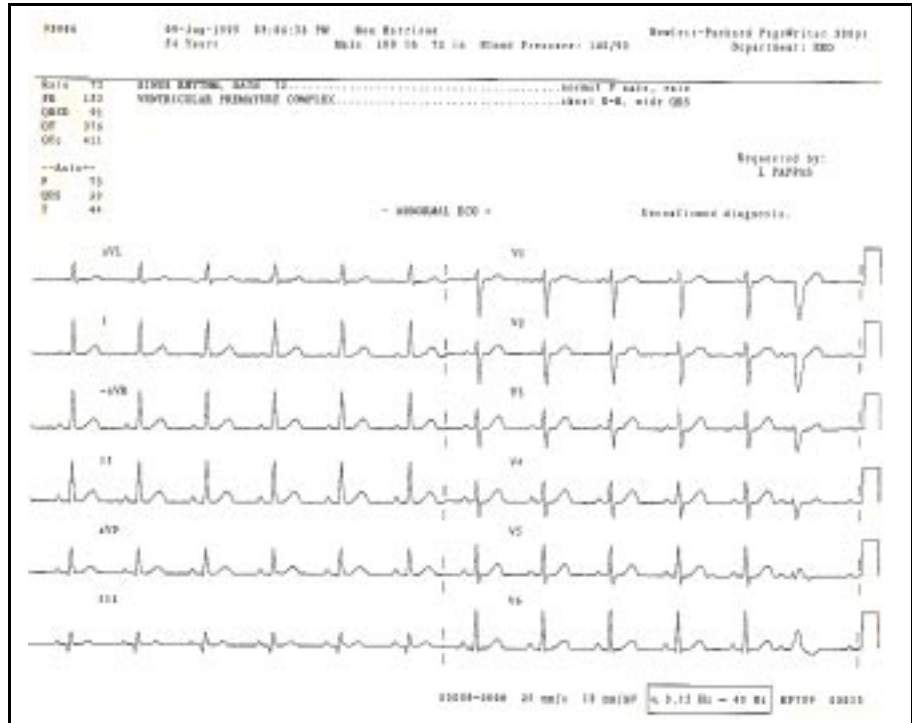

Figure 2-5: An Auto 6x2 ECG (6x2)



2

Figure 2-6: A Cabrera Auto 6x2 ECG (6x2)



## Manual Report Examples

The following figures show examples of Manual ECG report formats.

**Figure 2-7: A Manual 3-Lead ECG**

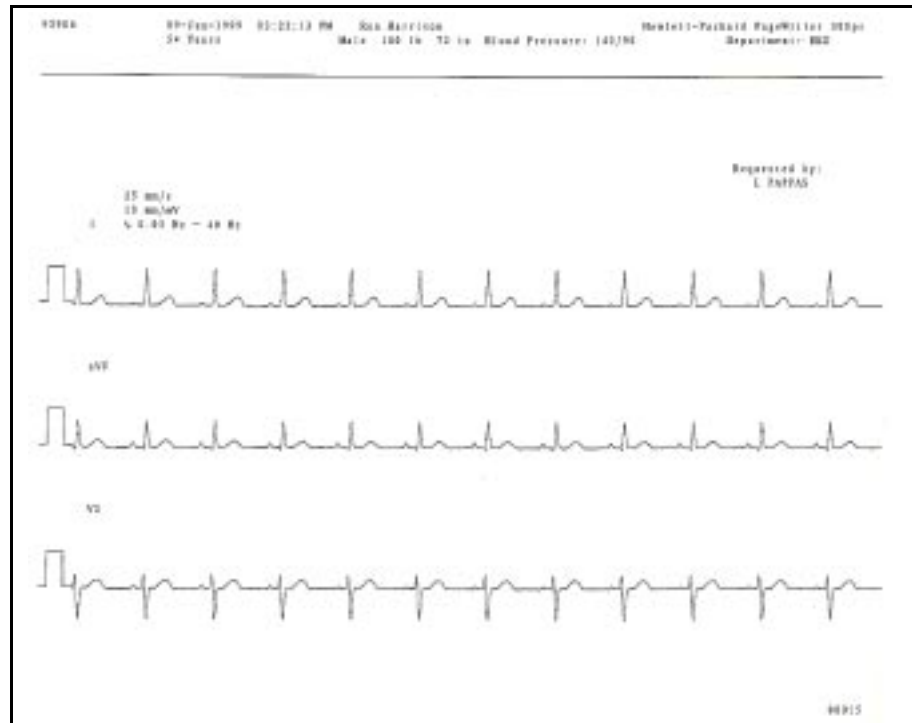

2

**Figure 2-8: A Manual 6-Lead ECG**

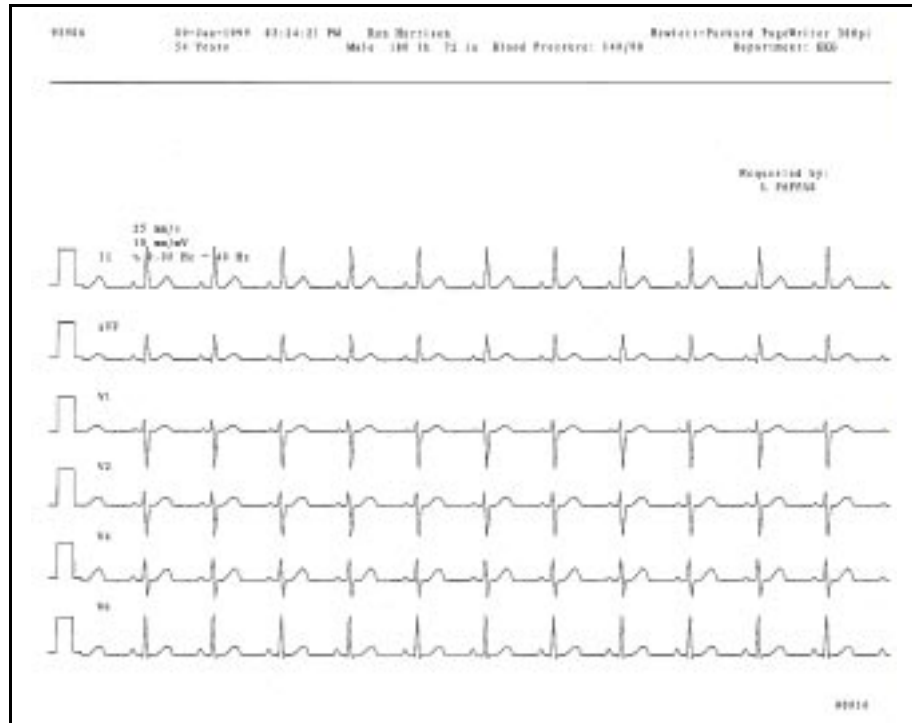
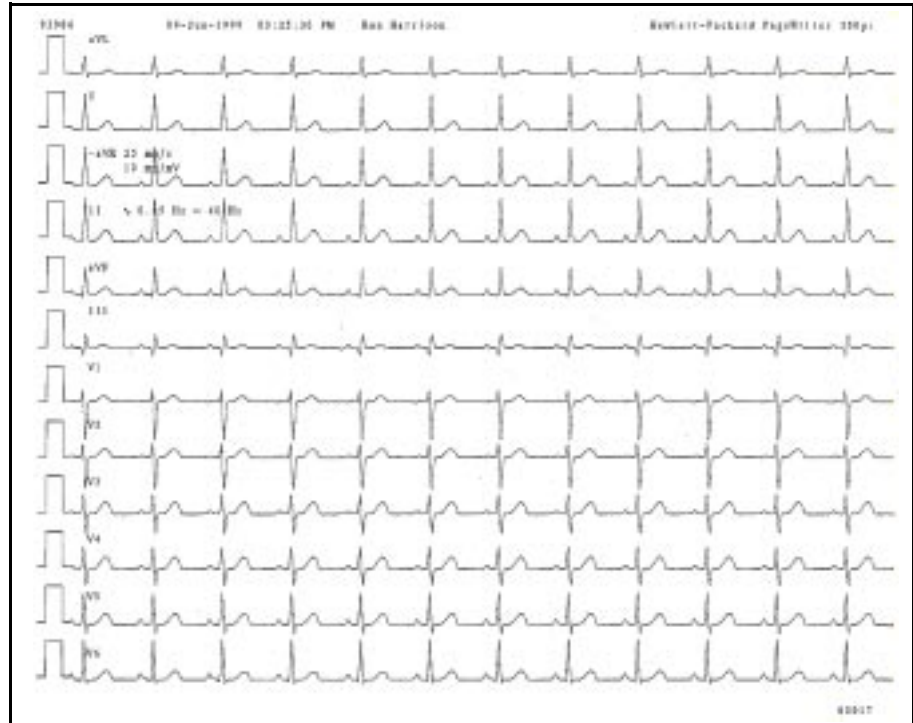

Figure 2-9: A Manual 12-Lead ECG



2

Figure 2-10: The TPI Report (H0 page 1)

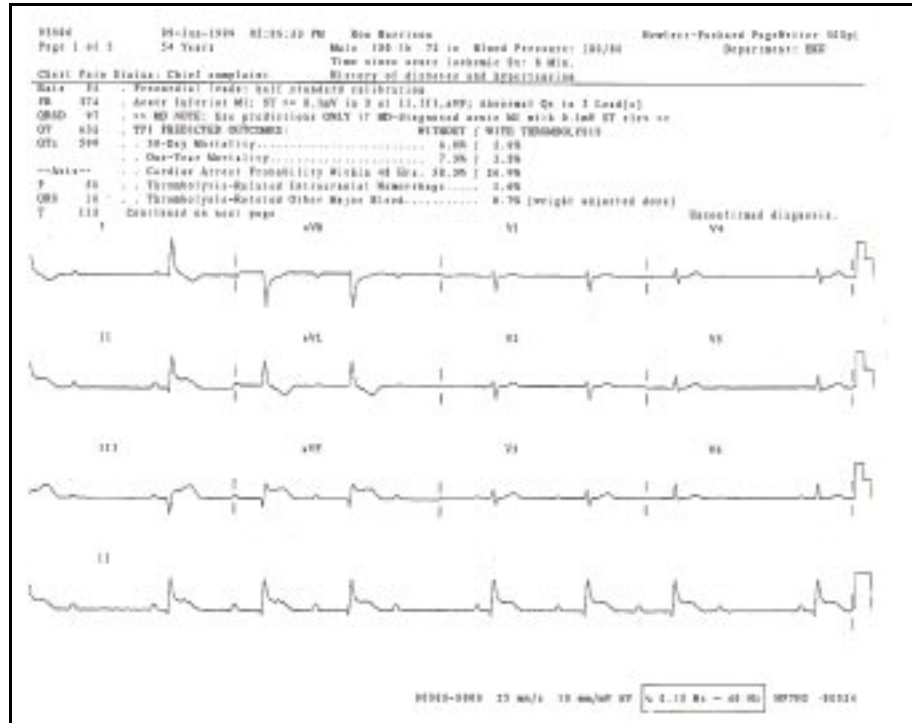

Figure 2-11: The TPI Report (HO page 2)

```
0100      00-100-100 00:00:01 00  Bob Harrison      Hewlett-Packard PageWriter 340pi
Page 2 of 2      34 Years      Moio 100 10 71 in Blood Pressure: 100/70      Department: 000
Time since last issuance: Ex. 3 Mo.
-----
Chief Data Officer: Chief complaint:      History of diabetes and hypertension
-----
SICR  04  -  NO NOTE: Consider in context of cardiovascular risk reduction
IN  03a  -  THIS NOTE IS A MONITORING INSTRUCTION.
CHSD  07  -  TIME SINCE SCHEMATIC APPOINTMENT:  E.M.S. | DM: Diabetes, Hypertension
QT  022
QTY  000

--Data--
P  01
QMS  14
T  111
                                         Monitored Diabetes.

0100-100  25 mm/s  10 mm/s VV  [ 8.10 Hz - 48 Hz ] 19700 0014
```

2







Figure 2-14: The Risk Management Report (RM)

<b>CHEST PAIN / POSSIBLE MYOCARDIAL ISCHEMIA</b> EMERGENCY MEDICAL RECORD SUPPLEMENTAL FORM		NAME: <u>Doc Services</u> ID: <u>9190</u> Dept: <u>ECG</u> Newell+Parsons PageHeader 04/91
CHEST PAIN/DISCOMFORT, Yes, chief complaint (MD Agree: <input type="checkbox"/> YES <input type="checkbox"/> NO, COMMENT: _____ )		Age: <u>54</u> Race: <u>White</u> 48-Jan-1999 01:27:41 PM
CHARACTER OF CHEST PAIN OR CHIEF COMPLAINT: _____ DURATION: _____ WHEN STARTED BY: _____ RELIEVED BY: _____ SUGGESTIVE OF ISCHEMIA? <input type="checkbox"/> YES <input type="checkbox"/> SUGGEST <input type="checkbox"/> NO PATIENT REPORTS PRIOR HEART ATTACK: <input type="checkbox"/> YES <input type="checkbox"/> NO PRIOR NITROGLYCERIN USE: <input type="checkbox"/> YES <input type="checkbox"/> NO ECG (ECG/ST-T/QT/QTc) (ECG DONE: 48-Jan-1999 01:27:41 PM)		
CHEST PAIN AT TIME OF THIS ECG? <input type="checkbox"/> YES <input type="checkbox"/> YES, BUT IMPROVED <input type="checkbox"/> NO. COMMENT: _____ Preordial leads: full standard calibration Inferior Q/RS/T in two or more of leads II, III, aVF No primary ST segment abnormalities detected Lateral T wave inversions of P, L aVF or none in two or more of leads I, aVL, V5-V6 ADDITIONAL ECG FINDINGS/COMMENT(S) TO ABOVE: _____ _____ COMPARED TO PRIOR ECG: <input type="checkbox"/> NO CHANGES <input type="checkbox"/> CHANGES: _____ <input type="checkbox"/> NO PRIOR ECG DONE <input type="checkbox"/> PRIOR ECG NOT AVAILABLE <input type="checkbox"/> PRIOR ECG NOT REQUESTED		
BY AECI-FIFI DEDUCTED PROBABILITY OF ACUTE ISCHEMIA = 71%, based on this information collected at the time of this ECG: Patient is male, age greater than 50 Patient has chief complaint of chest pain/discomfort or left arm pain Patient's ECG Q, ST, & T wave findings as noted above (1.011) 9.31(9 9.48)		
TREATMENT DECISION: <input type="checkbox"/> CCU/ICU <input type="checkbox"/> INTERMEDIATE CARE <input type="checkbox"/> WARD <input type="checkbox"/> HOME <input type="checkbox"/> OTHER: _____ IF NOT HOME, SPECIFIC FOLLOW-UP INSTRUCTIONS GIVEN TO PATIENT: <input type="checkbox"/> YES <input type="checkbox"/> NO <input type="checkbox"/> COPY IN SB MEDICAL RECORD ADDITIONAL COMMENTS: _____ PHYSICIAN SIGNATURE: _____ DATE: _____ TIME: _____		

# **3 Understanding ECG Analysis and the Predictive Instruments Applications**

This chapter explains how the cardiograph measures, analyzes and interprets (PageWriter 300pi only) ECG data, and what information is included on the Extended Measurements report. In addition, the Predictive Instruments applications of the PageWriter 300pi are described.

---

## **Understanding the ECG Analysis Program**

The ECG Analysis Program produces precise, accurate and consistent ECG measurements. If desired, it further provides interpretive statements which highlight key areas of concern for your review. These tools are most helpful if you understand how and why they work and how you can best use their capabilities. Figure 3-1 shows this process.

Figure 3-1: The ECG Analysis Program

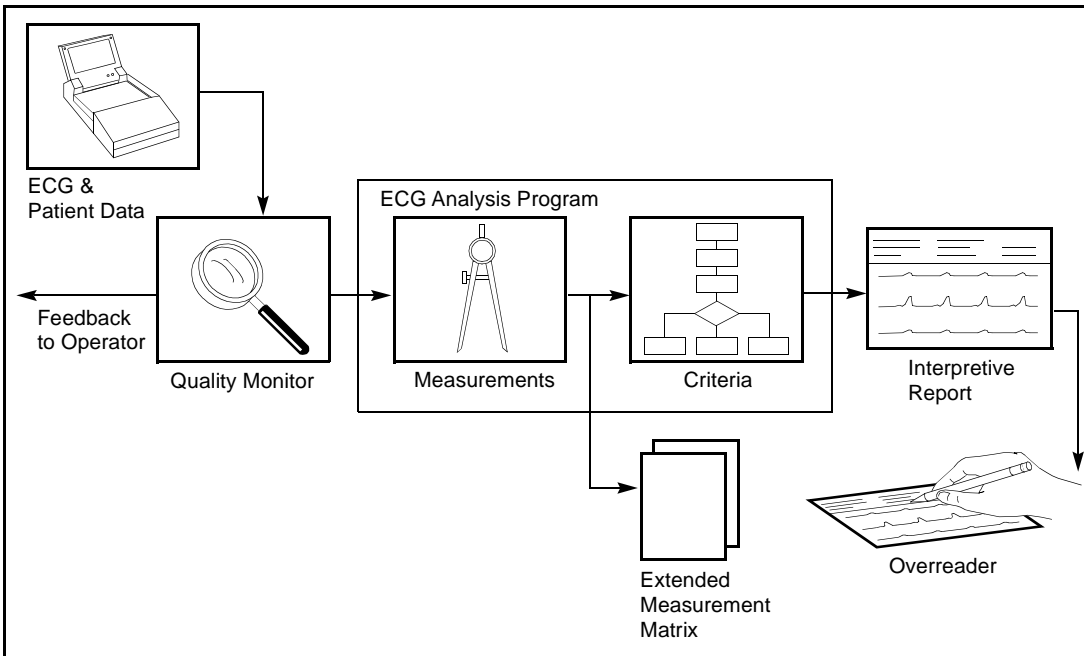

The analysis process begins with the simultaneous acquisition of the ECG's 12 conventional leads. It then proceeds through four steps before producing the interpreted ECG report. These steps are:

1. **Quality Monitor**—examines the technical quality of each ECG lead.
2. **Pattern Recognition**—locates and identifies the various waveform components.
3. **Measurement**—measures each component of the waveform and performs basic rhythm analysis, producing a comprehensive set of measurements.
4. **Interpretation (PageWriter 300pi only)**—uses the extended measurements, with information about the patient such as age and sex, to select those interpretive statements from the criteria program which summarize the findings for the ECG.

---

Agilent Technologies provides two standard criteria programs, adult and pediatric, for the PageWriter 300pi cardiograph. Patient information, including age, sex, height, and weight can be used by the criteria programs in selecting the interpretive statements.

---

**NOTE**

---

For more information about interpretation, see the *Interpretive Cardiograph Physician's Guide*.

---

---

## **How the PageWriter 200/300pi Measures ECGs**

The PageWriter 200/300pi calculates measurements for all the waveforms that you see on the Auto 3 x 4 report. Every beat in every lead is measured individually, allowing the natural variations among beats to contribute to the representative measurements. This is in contrast to other measurement methods in which a representative beat is constructed and then measurements are made only for the constructed beat. In the PageWriter 200/300pi cardiograph, representative group, lead and global measurements are calculated from combinations of the comprehensive set of measurements for each beat.

Figure 3-2: ECG Morphology Measurements

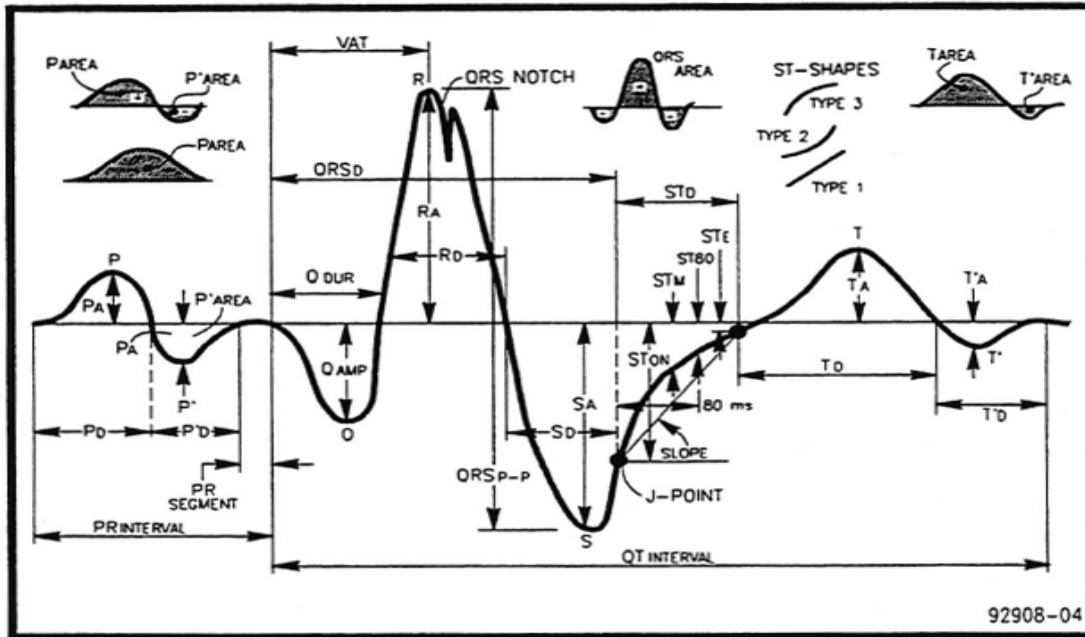

### Waveform Recognition

The first step of the measurement program involves waveform recognition and beat detection. A boundary indicator waveform in which QRS complexes and pacemaker spikes are enhanced is derived from all leads over the ten-second analysis period. After the approximate QRS complex and pacemaker spike locations are known, another boundary indicator waveform that enhances P and T wave detection is derived. Approximate P wave, QRS complex and T wave regions are then determined for each beat in the ECG.

### Comprehensive Measurements

After the approximate waveform locations are known, they are further refined to determine precise onsets and offsets for each waveform. Once onsets and offsets are known, amplitude, duration, area and shape are calculated for every P wave, QRS complex, T wave and ST segment in every lead that you see on the Auto 3 x 4 report. Waveform irregularities such as notches, slurs, delta waves and pacemaker spikes are also noted for every beat. A table of all

---

these measurements is created, from which the representative measurements are calculated.

### **Group Measurements**

After all the beats have been measured, each beat in the ECG is classified into one of five rhythm groups based on rate and morphology parameters. Each group consists of beats with similar R-R intervals, durations, and shapes, except that all paced beats are grouped together, regardless of other parameters. Group 1 represents the type of beat that is most normal or predominant and groups 2 through 5 represent other beat types. The group into which each beat is classified is noted under the heading “Rhythm Grouping of Beats” on the Extended Measurements report. Group measurements are calculated by averaging the measurements for all the beats in each of the groups and are reported in the Rhythm Analysis section of the Extended Measurements report.

### **Lead Measurements**

Representative measurements for each of the 12 leads are calculated from the comprehensive set of measurements for all the beats in the ECG. Only the beats of the predominant group (Group 1) are used. If a particular lead (as shown on the Auto 3 x 4 report) does not have any Group 1 beats, a beat group with similar parameters is used, if possible. The measurement program tries to select a beat group for which the beats are not paced. Only if all beats in the ECG are paced will the measurements be for paced beats. If there are paced and non-paced beats in an ECG, only the non-paced beats will be measured, which may result in leads for which no measurements are reported.

In each lead, the measurements for all the beats belonging to the selected beat group are averaged. The lead measurements are representative of the dominant waveform present in each lead and are reported in the Morphology Analysis section of the Extended Measurements report.

### **Atrial Rhythm Analysis**

Atrial rhythm is determined by examining leads V1, aVF, II and III in succession until the program can report conclusively that there are multiple P waves, that there are no P waves, or that there is one P wave per QRS complex. If a conclusive result is achieved, then the last lead analyzed will be used to calcu-



late group and global atrial rhythm parameters. If no conclusive result is achieved, no atrial rhythm parameters are calculated.

### **Global Measurements**

The global measurements for the ECG, including the frontal and horizontal plane axis measurements, are reported to the right of the lead measurements in the Morphology Analysis section of the Extended Measurements report.

These interval, duration, and segment measurements are weighted averages of the lead measurements. The global rate reported is the mean ventricular rate over the entire ECG unless the ECG criteria program determines that one of the group mean ventricular rates is more representative of the underlying rhythm.

### **Axis Measurements**

Although when making axis measurements manually, it is most convenient to use waveform amplitudes, using areas yields more accurate results. The PageWriter 200/300pi uses the waveform areas from the lead measurements in calculating the P, QRS and T axes, while the sum of the ST onset, middle and end amplitudes is used in calculating the ST axis. For the frontal plane axis measurements, which use the limb leads, nine lead pairs, all at least 60 degrees apart, are used to estimate the axes. The resulting estimates are examined to ensure that they converge to a single result. If so, they are averaged to form the representative axis measurement. The horizontal plane axis measurements, which use leads V1-V6, are calculated similarly from seven lead pairs.

The representative measurements are reported on the Extended Measurements report.

---

## **Automatically Measuring and Interpreting ECGs**

The PageWriter 200/300pi uses the ECG Analysis Program to produce precise, accurate and consistent ECG measurements. In the PageWriter 300pi, the program further provides interpretive statements that highlight key areas of concern for your review. The primary objective of interpretation is to help the physician in making a clinical diagnosis. The interpreted results are best used in conjunction with the physician's knowledge of the patient, the results of the physical examination, the ECG tracing, and other findings. This tool is most helpful, however, if you understand how and why it works, and how you can best use its capabilities.

The ECG Analysis Program uses the following patient ID entries for interpretation: age, sex, height, and weight.

See the *Physician's Reference Guide* (part number M1700-92908) for detailed information about the ECG Analysis Program.

## Understanding the Extended Measurements Report

### The Extended Measurements Report

The two-part Extended Measurements report summarizes the morphology and rhythm characteristics for the individual leads and rhythm groups in the ECG. The ECG Analysis Program uses the Extended Measurements report information to generate interpretive statements. An Extended Measurements report is available for each ECG when it is recorded or later if the ECG is stored.

To print a copy of the extended measurements report for the most recent ECG, press the **Shift** and **Copy** keys at the same time.)

Figure 3-3: An Extended Measurements Report (Morphology)

12040		04-Oct-2002 04:59:12		John Doe		Newline-Package PageWriter 508pi									
43 Years Male 180 kg 180 cm		Blood Pressure: 100/70		Room:485		Page 3 of 3									
7- 32		SEPTA		-- MORPHOLOGY ANALYSIS --											
I	II	III	aVR	aVL	aVF	VI	V1	V2	V3	V4	V5	V6	CAL FACTORS		
0.28	0.40	0.13	-0.36	0.07	0.37	[ P AMP ]	0.35	0.29	0.40	0.59	0.40	0.27	1.00	1.00	1.00
88	88	88	88	88	93	[ P DUR ]	88	88	88	104	93	114			
3.4	4.9	1.3	-0.9	0.7	3.3	[ P AREA ]	1.9	3.4	4.9	7.2	4.8	3.2			
						[ P NOTCH ]									
						[ P' AMP ]									
						[ P' DUR ]									
						[ P' AREA ]									
-0.19	-0.29	-0.46		-0.18		[ Q AMP ]	-0.31	-0.20	-0.23	-0.39	-0.26	-0.19			
17	19	16		23		[ Q DUR ]	20	20	20	27	17	14			
1.47	1.10	0.40	0.25	0.44	1.43	[ R AMP ]	0.39	1.51	2.13	3.17	2.13	1.40			
46	48	48	25	49	45	[ R DUR ]	44	44	44	40	48	40			
-0.16	-0.20	-0.40	-1.07	-0.19	-0.19	[ S AMP ]	-0.10	-0.20	-0.20	-0.41	-0.27	-0.19			
16	17	16	41	19		[ S DUR ]	20	27	25	21	20	20			
		0.22				[ S' AMP ]									
		19				[ S' DUR ]									
						[ S' AREA ]									
7.0	10.2	2.3	-0.8	2.7	0.9	[ QRSAREA ]	3.7	7.2	10.2	13.0	10.3	7.0			
						[ QRSWID ]									
						[ DELTA ]									
-0.03	-0.03	-0.02		0.04	-0.02	[ ST QRS ]	0.20	0.30	-0.01	0.01	-0.03				
						[ ST MEAN ]	0.13	0.40	0.33	-0.01	0.02	-0.01			
0.21	0.31	0.19		0.03	0.20	[ ST RAMP ]	0.20	0.40	0.43	0.21	0.27	0.10			
0.21	0.31	0.19	0.01	0.04	0.20	[ ST RMS ]	0.28	0.13	0.43	0.21	0.27	0.10			
64	34	89	112	134	72	[ ST DUR ]	104	140	40	40	40	44			
62	60	45	20	29	44	[ STALOPH ]	57	8	31	71	70	30			
9	9				9	[ STHAPH ]				9	9	0			
0.51	0.13	0.26	-0.03	0.10	0.30	[ T AMP ]	0.28	0.23	0.70	1.10	0.74	0.31			
104	190	174	100	210	140	[ T DUR ]	103	144	140	100	144	170			
13.1	10.0	0.9	-14.7	4.9	11.9	[ T AREA ]	6.4	12.0	17.0	23.2	10.0	12.0			
						[ T NOTCH ]									
						[ T' AMP ]									
						[ T' DUR ]									
						[ T' AREA ]									
404	400	400	394	412	400	[ PR INT ]	214	224	230	400	472	476			
314	312	310	312	332	306	[ PR SEC ]	132	132	132	374	340	340			
63	43	40	71	33	47	[ V.A.T. ]	64	40	40	61	41	40			
1.40	2.45	0.70	1.00	0.44	1.01	[ QRS PPR ]	0.90	1.71	2.41	3.10	2.40	1.67			
83	84	80	83	89	87	[ QRS DUR ]	84	91	89	84	80	84			
330	334	322	332	370	334	[ QRS INT ]	340	334	334	330	332	324			
3	1	1	3	1	1	[ QRSDEF ]	3	1	1	1	1	1			
						[ QUALITY ]									
						[ NOISE ]									

### Morphology Analysis

The following tables define the parameters in the order that they appear on the morphology analysis page of the extended measurements report.

#### Individual Lead Measurements

Table 3-1 lists every representative measurement in each lead. The parameters in the following tables are shown in Figure 3-4.

Figure 3-4: ECG Morphology Measurements

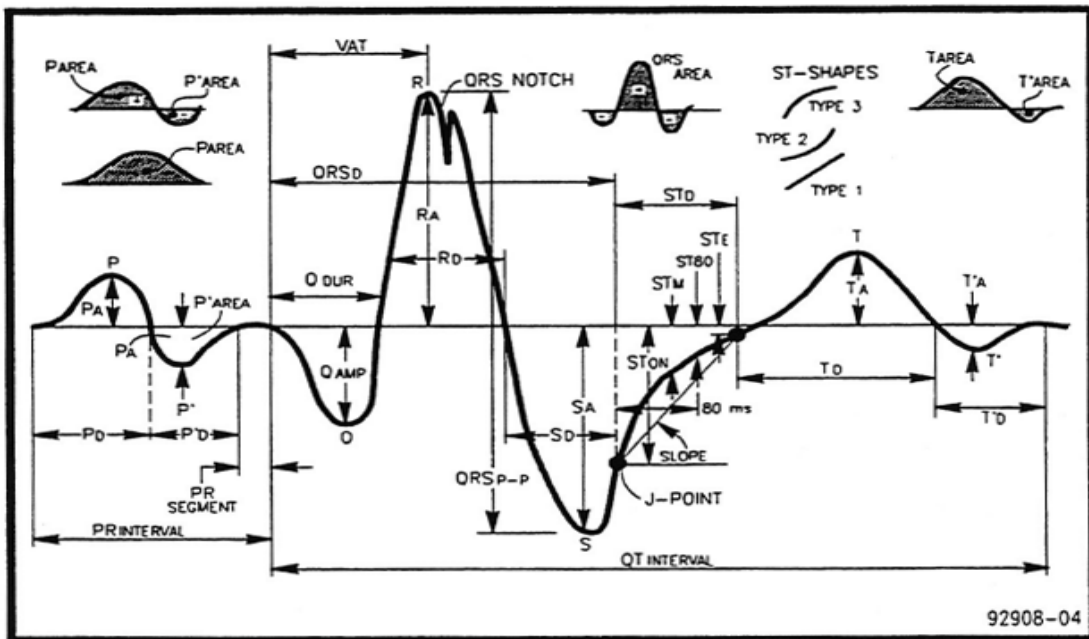

Table 3-1: Individual Lead Measurements

Parameter	Units or Value	Description
P AMP	millivolts	P wave amplitude
P DUR	milliseconds	P wave duration

**Table 3-1: Individual Lead Measurements (Continued)**

Parameter	Units or Value	Description
P AREA	Ashman units (40 ms x 0.1 mV)	P wave area for monophasic P waves or the area of the initial portion of a biphasic P wave.
P NOTCH	Yes or No	Indicates the presence or absence of a notch in the P wave.
P' AMP	millivolts	P' wave amplitude
P' DUR	milliseconds	P' wave duration
P' AREA	Ashman units (40 ms x 0.1 mV)	Area of the terminal portion of a biphasic P wave.
Q AMP	millivolts	Q wave amplitude
Q DUR	milliseconds	Q wave duration
R AMP	millivolts	R wave amplitude
R DUR	milliseconds	R wave duration
S AMP	millivolts	S wave amplitude
S DUR	milliseconds	S wave duration
R' AMP	millivolts	R' wave amplitude
R' DUR	milliseconds	R' wave duration
S' AMP	millivolts	S' wave amplitude
S' DUR	milliseconds	S' wave duration
QRSAREA	Ashman units (40 ms x 0.1 mV)	The area of the QRS complex.

**Table 3-1: Individual Lead Measurements (Continued)**

Parameter	Units or Value	Description
QRSNTCH	+ or -	Indicates a notch in the QRS complex. A + indicates a notch or slur in the R or R' wave. A - indicates a notch or slur in the Q, S, or S' wave.
DELTA	Yes or No	Indicates the presence or absence of pronounced delta waves preceding QRS complexes.
ST ON	millivolts	Elevation or depression at the onset (J point) of the ST segment.
ST MID	millivolts	Elevation or depression at the midpoint of the ST segment.
ST 80ms	millivolts	Elevation or depression of the ST segment 80 ms after the end of the QRS complex (J point).
ST END	millivolts	Elevation or depression at the end of the ST segment.
ST DUR	milliseconds	ST segment duration.
STSLOPE	degrees	ST segment slope. Slope is measured in degrees and can range from 0 to $\pm 90$ degrees
STSHAPE	-, V, or ^	The ST segment shape: - = Straight V = Concave upward ^ = concave downward
T AMP	millivolts	T wave amplitude
T DUR	milliseconds	T wave duration
T AREA	Ashman units (40 ms x 0.1 mV)	T wave area for monophasic T waves or the area of the initial portion of a biphasic T wave.
T NOTCH	Yes or No	Indicates the presence or absence of a notch in the T wave.



**Table 3-1: Individual Lead Measurements (Continued)**

Parameter	Units or Value	Description
T' AMP	millivolts	T' wave amplitude
T' DUR	milliseconds	T' wave duration
T' AREA	Ashman units (40 ms x 0.1 mV)	Area of the terminal portion of a biphasic T wave.
PR INT	milliseconds	Interval from the onset of the P wave to the onset of the QRS complex.
PR SEG	milliseconds	Interval from the end of the P wave to the onset of the QRS complex.
V.A.T.	milliseconds	Ventricular Activation Time: the interval from the onset of the QRS complex to the latest positive peak in the complex, or the latest substantial notch on the latest peak, whichever is later.
QRS PPK	millivolts	Peak-to-peak QRS complex amplitude.
QRS DUR	milliseconds	QRS complex duration, measured from its onset to the ST segment onset (J point).
QT INT	milliseconds	Interval from the onset of the QRS complex to the end of the T wave.
GROUP	1 (or 2 - 5)	Indicates the rhythm group used to derive the representative measurements for each lead. Will be Group 1 unless no Group 1 beats were detected during the analysis interval for this lead.

**Table 3-1: Individual Lead Measurements (Continued)**

Parameter	Units or Value	Description
QUALITY	N/A	Each character indicates a type of noise present in the lead: <b>D</b> - Baseline wander indicator. The onsets of two successive QRS complexes differ by more than 1/3 the calibration value. <b>T</b> - Artifact, most likely muscle tremor. Occurs when more than 16 up-and-down strokes exceeding 1 mm in amplitude are detected within 1 second. <b>W</b> -Steady baseline drift exceeding 10 mm/sec. <b>A</b> -Power line (AC) noise. <b>M</b> -Missing lead.
NOISE	N/A	Indicates the severity of artifact reflected in the signal data: blank = Light noise 1 = Moderate noise 2 = Marked noise 3 = Severe noise

An Ashman unit is the area of 1 square millimeter at normal speed (25 mm/sec) and normal sensitivity (10 mm/mV). An Ashman unit equals 40 ms x 0.1 mV.





### Cal Factors

The factor by which the ECG trace differs from standard scaling (10 mm/mV). Standard scaling is indicated by a CAL factor of 1.00.

**Table 3-2: Cal Factors**

Parameter	Units or Value	Description
**Cal Assumed**	Appears only when true	The cal pulses were measured to be of non-standard amplitude or shape. This may indicate a cardiograph malfunction.
**Paced Beats Measured**	Appears only when true	All beats are paced and measurements are for paced beats.
**QRS-like Artifact Detected**	Appears only when true	Spike-like artifact was detected that may have caused measurement error.
**Cart 1/2V**	Appears only when true	Cart was set to print chest leads at half the scale of the limb leads.
**Computer 1/2V**	Appears only when true	The ECG Management System automatically scaled the chest leads at half the scale of the limb leads. This message can only appear on ECGs printed by the ECG Management System.

### Frontal/Horizontal

The following table lists frontal plane and horizontal plane axis parameters and the global measurements representative of the entire ECG.

**Table 3-3: Frontal/Horizontal**

Parameter	Units or Value	Description
P	degrees	P wave axis.
I:40	degrees	Initial 40 ms QRS complex axis.
QRS	degrees	Mean QRS complex axis.
T:40	degrees	Terminal 40 ms QRS complex axis.

**Table 3-3: Frontal/Horizontal**

Parameter	Units or Value	Description
ST	degrees	ST segment axis.
T	degrees	T wave axis.
Mean Ventr. Rate	beats per minute	Representative ventricular rate for the entire ECG.
Mean PR Int.	milliseconds	Representative PR interval for the entire ECG.
Mean PR Seg.	milliseconds	Representative PR segment for the entire ECG.
Mean QRS Dur.	milliseconds	Representative QRS duration for the entire ECG.
Mean QT Int.	milliseconds	Representative QT interval for the entire ECG.
Mean QT <sub>c</sub>	milliseconds	Representative QT interval adjusted to a heart rate of 60 beats/minute.

**Analysis Statement Codes (PageWriter 300pi only)**

These codes are the criteria codes for the interpretive statements printed on the Interpretive report.

## Rhythm Analysis

### Group Measurements

Figure 3-5: Extended Measurements Report (Rhythm)

```

12040      04-Oct-1992  00:20:02      John Doe      Hewlett-Packard PageWriter 500pi
43 Years Male 160 kg 160 cm Blood Pressure: 120/90 Norm:000
-- RHYTHM ANALYSIS --
Group Group
GROUP MEASUREMENTS: 1 2
Member Count : 2 2
Member % : 73 36
Longest Run : 3 1
Mean QRS Duration : 84 88
Low Vent Rate : 64 51
Mean Vent Rate : 73 51
High Vent Rate : 74 51
V-Rate Std. Dev. : 4 0
Mean RR Interval : 844 815
Mean Atrial Rate : 423 0
A-Rate Std. Dev. : 100 0
Avg P Count : 4 0
P Sec. Avg. P Rate : 0 0
Low PR Interval : 0 0
Mean PR Interval : 364 156
High PR Interval : 470 156
PR Int. Std. Dev. : 100 0
Mean PR Segment : 279 76
Mean QT Interval : 352 355
Comp. P-Rate Count : 0 0

GROUP FLAGS:
Artificial Pace : No No
Interpolated Beat : No No
Ectopic Atrial : No No
PR Segment Longer : No No
Wenckebach : No No
Bigeminy : No Yes
Trigeminy : No Yes
Abnormal Shape : No No
Mell. P-Tint Obs. : Yes No
QRS Measured : Yes Yes

GLOBAL RHYTHM PARAMETERS:
Atrial Rate : 362
Low Vent Rate : 31
Mean Vent Rate : 40
High Vent Rate : 74
P-R-T Morph : 1
Fixed Mell. P Morph : No
Mell. P-Tint Valid : Yes
Beta Wave Count : 0 ( 0%)
Bigeminy Count : 0 STRING: 0
Trigeminy Count : 0 STRING: 0
Wenckebach Count : 0 STRING: 0

RHYTHM GROUPING ON BEATS:
-----
1 1 -- 2 1 1 -- 1 2 3 -- 1 1 0
    
```

HP170 0000-0100  
% 0.13 Hz - 60 Hz 0000

The following are parameters given for each rhythm group detected by the PageWriter 200/300pi during the analysis interval.

**Table 3-4: Group Measurements**

Parameter	Units or Value	Description
Member Count	N/A	Number of beats in the rhythm group.
Member%	percentage	Percentage of the total number of beats represented by the rhythm group.
Longest Run	N/A	Longest contiguous run of beats in the rhythm group.
Mean QRS Duration	milliseconds	Average QRS duration in the rhythm group.
Low Ventr Rate	beats per minute	Lowest ventricular rate in the rhythm group.
Mean Ventr Rate	beats per minute	Average ventricular rate in the rhythm group.
High Ventr Rate	beats per minute	Highest ventricular rate in the rhythm group.
V-Rate Std. Dev.	N/A	Standard deviation of the ventricular rate in the rhythm group.
Mean RR Interval	milliseconds	Average interval between R waves in the rhythm group.
Mean Atrial Rate	N/A	Average atrial rate in the rhythm group.
A-Rate Std. Dev.	N/A	Standard deviation of the atrial rate in the rhythm group.
Avg. P Count	N/A	Average number of P waves per QRS complex in the rhythm group.
# Not Avg P Beats	N/A	Number of QRS complexes in the rhythm group which do not have the average number of P waves per QRS complex.

**Table 3-4: Group Measurements**

Parameter	Units or Value	Description
Low PR Interval	milliseconds	Shortest PR interval in the rhythm group.
Mean PR Interval	milliseconds	Average PR interval in the rhythm group.
High PR Interval	milliseconds	Longest PR interval in the rhythm group.
PR Int. Std. Dev.	N/A	Standard deviation of the PR interval in the rhythm group.
Mean PR Segment	milliseconds	Average PR segment in the rhythm group.
Mean QT Interval	milliseconds	Average QT interval in the rhythm group.
Comp. Pause Count	N/A	Number of beats followed by a compensatory pause in the rhythm group.

### Group Flags

The parameters in this part of the rhythm analysis indicate the presence or absence of various rhythm-related conditions in the rhythm groups identified.

**Table 3-5: Group Flags**

Parameter	Units or Value	Description
Artificial Pace	Yes or No	Indicates that beats in the rhythm group are paced. All paced beats are grouped together.
Interpolated Beat	Yes or No	Indicates that the rhythm group contains only interpolated beats.
Sinus Arrest	Yes or No	Indicates a prolonged R-toR interval. Set for the sinus arrest resumption group.
PR Progress Longer	Yes or No	Indicates the PR interval is getting progressively longer in the rhythm group.
Wenckebach	Yes or No	Indicates presence of the Wenckebach phenomenon in the rhythm group.
Bigeminy	Yes or No	Indicates presence of a bigeminy rhythm. Set for the group consisting of ectopic beats.
Trigeminy	Yes or No	Indicates presence of a trigeminy rhythm. Set for the group consisting of ectopic beats.
Aberrant Shape	Yes or No	Indicates that beats in the rhythm group are in the minority and are wider than other beats from the same lead(s).
Mult. P Test Done	Yes or No	Indicates that beats in the rhythm group were tested for multiple P waves.
QRS Measured	Yes or No	Indicates that QRS-related parameters were measured in the rhythm group.

**Global Rhythm Parameters**

The following parameters provide global information for beats in the ECG.

**Table 3-6: Global Rhythm Parameters**

Parameter	Units or Value	Description
Atrial Rate	Beats per minute	The representative atrial rate for the analysis interval. This is not a simple arithmetic average.
Low Ventr Rate	Beats per minute	The lowest ventricular rate during the analysis interval.
Mean Ventr Rate	Beats per minute	The average ventricular rate during the analysis interval.
High Ventr Rate	Beats per minute	The highest ventricular rate during the analysis interval.
Flut-Fib Indicator	N/A	Indicates approximate number of flutter-like or coarse fibrillatory waves per lead.
Fixed Mult P Morph	Yes or No	Indicates that all P waves are of consistent morphology.
Mult P Test Valid	Yes or No	Indicates that the tests performed to detect multiple P waves produced consistent results.
Delta Wave Count	N/A	Number of QRS complexes with pronounced delta waves.
Delta Wave%	Percentage	Percent of total beats with pronounced delta waves.
Bigeminy Count	N/A	Total number of beats in a bigeminy pattern, whether or not they are contiguous.
Bigeminy String	N/A	Total number of beats in the longest continuous bigeminy pattern.
Trigeminy Count	N/A	Total number of beats in a trigeminy pattern, whether or not they are contiguous.

Parameter	Units or Value	Description
Trigeminy String	N/A	Total number of beats in the longest continuous trigeminy pattern.
Wenckebach Count	N/A	Total number of Wenckebach cycles. A Wenckebach cycle is a series of beats whose PR intervals grow progressively longer, culminating in an unusually long RR interval, (a dropped beat).
Wenckebach String	N/A	The number of beats preceding the dropped beat.

### Rhythm Grouping of Beats

The Rhythm Grouping of Beats is a number string which relates spatially to the beats in the ECG and shows the rhythm group number for each beat as determined by the Rhythm Analysis portion of the Analysis Program.

Possible values are:

1,2,3,4, or 5	Rhythm group number
0	Beat unclassifiable by program
— —	Lead switching interval
NO MEAS	Program unable to measure any beats in the lead set.



---

## Understanding the PageWriter 300pi Predictive Instrument Applications

The ACI TIPI (Acute Cardiac Ischemia- Time Insensitive Predictive Instrument) and the TPI (Thrombolytic Predictive Instrument) are software products that enhance the computer-assisted ECG analysis capabilities of the PageWriter 300pi Cardiograph. These "Predictive Instruments" generate 0-100% Predicted Probability scores of ACI (Acute Cardiac Ischemia) and patient outcome with and without thrombolytic therapy for acute myocardial infarction (AMI). These predicted probabilities are based on ECG features,



patient age, gender, blood pressure, chest pain status and time since ischemic symptom onset. The cardiograph can be configured to automatically print these probabilities on the Auto ECG report.

Figure 3-6 illustrates the Predictive Instrument Application process. If TPI is enabled, the Predictive Instrument Application produces the H0 report. If ACI-TIPI is enabled, the Predictive Instrument Application produces the RM, T0, and 09 reports.

**Figure 3-6: The Predictive Instrument Application**

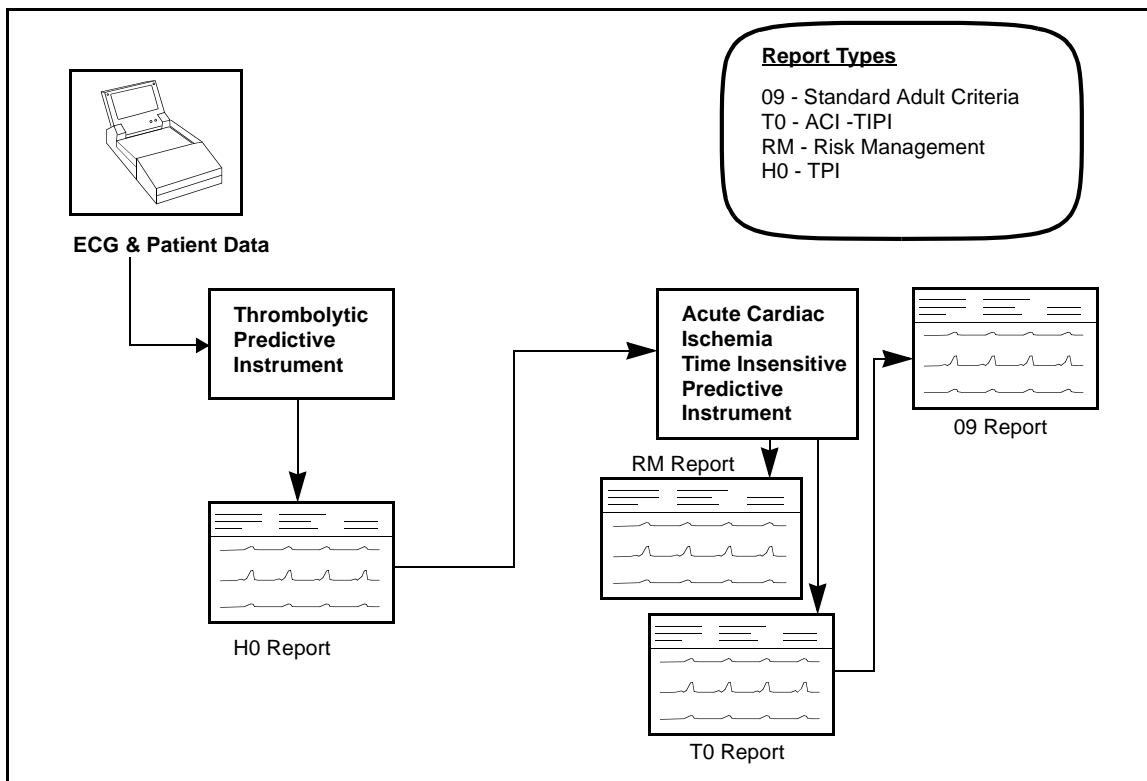

### Indications for Use

The ACI-TIPI is intended for use as an aid to clinicians in the diagnosis and triaging decision process of patients with ACI, which includes unstable angina pectoris and acute myocardial infarction (AMI).

The TPI is intended for use as an aid to clinicians identifying which patients with AMI are appropriate candidates for thrombolytic therapy. TPI is intended for adult patients, aged 35-75, diagnosed with symptoms of acute myocardial infarction.

These programs can be used in real-time and retrospective settings since they rely on information that is readily available in the emergency department (ED), or by retrospective review of the patient's medical record. The emergency physician's real-time decision making process is aided by having the predictive instruments incorporated into the electrocardiograph. The predictive scores, once acquired, can then be used along with actual patient outcome to help improve patient management practices retrospectively.

The predictive instruments provide the physician with tools to:

- Aid diagnosis and triage of some patients with symptoms suggestive of ACI
- Identify those patients most likely to benefit from thrombolytic therapy
- Facilitate the earliest possible administration of thrombolytic therapy

---

**NOTE**

---

For intended use and contraindication information, consult the *Predictive Instrument Physician's Guide* for important information.

---

### **Understanding TPI Variables**

There are nine predictors of thrombolytic-related benefits and risks which include six clinical factors and detailed information on three ECG features.

The six clinical factors are:

- Time since ischemic onset
- Patient age
- Patient gender
- Patient Blood Pressure (systolic and diastolic)
- Patient's history of diabetes
- Patient's history of hypertension

The three ECG features are:

- the presence or absence of pathological or significant Q waves
- the presence and degree of ST segment elevation or depression
- the presence and degree of T wave elevation or inversion

### **Understanding ACI TIPI Variables**

Seven variables are used to predict Acute Cardiac Ischemia. These variables include four clinical factors and detailed information on three ECG features.

The four clinical factors are:

- the presence or absence of chest pain or pressure, or left arm pain
- whether chest pain or pressure, or left arm pain is the patient's most important presenting symptom
- patient age
- patient gender

The three ECG features are:

- the presence or absence of pathological or significant Q waves
- the presence and degree of ST segment elevation or depression
- the presence and degree of T wave elevation or inversion

The four clinical factors must be entered by the clinician before a ACI TIPI analysis can be performed.

The exclusionary cases for both the TPI and ACI TIPI applications are listed in the *Predictive Instrument Physician's Guide*. Please refer to this document for this information.

### Using the TPI and ACI TIPI Applications

To use the TPI and ACI TIPI applications, you must configure the cardiograph and enable the applications. There are several types of reports that are produced by the cardiograph. These reports are summarized in Table 3-7.

**Table 3-7: PageWriter 300pi Reports**

Report Type	Contents of Report	Notes
Standard 09 (Std 09)	ECG waveforms, measurements, ECL 09 Adult Interpretation	
Standard P4 (Std P4)	ECG waveforms, measurements, ECL P4 Pediatric Interpretation	
ACI-TIPI (T0)	ECG waveforms, TIPI Analysis, No Risk Management Report	
Risk Management	Risk Management Report —1 page summarizing clinical information and can be used by the Clinician to document clinical decisions	Only available when T0 is enabled
TPI (H0)	ECG waveforms, TPI Analysis	
08/ACI-TIPI (T8)	ECG waveforms, measurements, ECL 08 Adult Interpretation and ACI-TIPI Analysis	



---

**NOTE**

---

To configure your cardiograph to interpret with ECL 08 criteria without the ACI-TIPI analysis, perform the following steps:

1. From the Configuration Menu, select Setup Predictive Instruments.
  2. From the Setup Predictive Instruments Menu, set 'Interp Criteria?' to Adult 08/TIPI."
  3. Exit the Setup Predictive Instruments Menu and return to the configuration menu by pressing 'Exit'.
  4. Use the arrow keys and select Setup ID Entry
  5. Disable the 'Chest/LA Pain' entry by selecting 'No'.
  6. Save this configuration by pressing 'Exit'.
- 

### **Analyzing an ECG with the Predictive Instruments**

The flexibility of the PageWriter 300pi allows you to configure the Predictive Instruments based on the type of patients presenting in your clinical setting. Figure 3-6 illustrates the method by which the PageWriter 300pi processes an ECG and prints reports. Using the Configuration Menu, you can setup your cardiograph to provide the desired analysis.

### **Obtaining Alternate Reports**

To obtain other Auto reports without changing the global configuration, the PageWriter 300pi features softkeys which can be selected quickly.

1. From the main display, press the **F1** key until 'Auto Analysis' appears.
2. Press the **F3** key to select the desired report format.

This will not change the global cardiograph configuration. The cardiograph will revert to the last saved storage/transmission configuration options if the cardiograph is powered off. The only desired report is printed and the appropriate Predictive Instruments are enabled depending on the choice.

## 4 ECG Storage (Options #A05 or StressWriter)

This chapter contains information about storing ECGs using the internal memory of the PageWriter 200/300pi, Options #A05 or StressWriter. Information about using and printing the Log of ECGs Taken and the Log of ECGs Stored is also included.

---

### Advantages of Storage

Storing ECGs allows you to recall the ECGs later as needed. Individual ECGs or groups of ECGs can be recalled for re-analyzing, editing, printing, or transmitting.

ECGs are stored at a resolution of 500 samples per second, and include a full ten seconds of data for all leads. Up to thirty Auto ECGs may be stored in the internal memory. Only Auto ECGs can be stored. Manual ECGs cannot be stored. An ECG must be stored before it can be transmitted.

When you finish acquiring and printing an ECG, you can choose whether or not to store it. You can store an ECG without entering patient ID information. The cardiograph records the ECG with a patient ID of “Unknown”. If you store the ECG with no patient ID information or with partial ID information, you can edit the patient ID information later, and then reprint the edited reports. The PageWriter 200/300pi stores the ECG measurements and the ECG copy interpretation.

---

## Storing ECGs

To store the ECG, perform the following steps:

1. After the ECG report prints, the following message will appear on the screen:

Store ECG?  
Patient ID: 23456  
Name: Ian Harrison

Yes No

F1 F2 F3 F4 F5

2. Press **Yes** (**F1**) to store the ECG,

**OR**

press **No** (**F5**) to continue without storing the ECG.

---

### NOTE

If you select **No**, you cannot store the ECG later, or transmit the ECG.

3. If you select **Yes**, the message “Storing ECG...” appears on the screen until storage is complete.

4. If the storage memory is full when you attempt to store an ECG, the following screen appears:

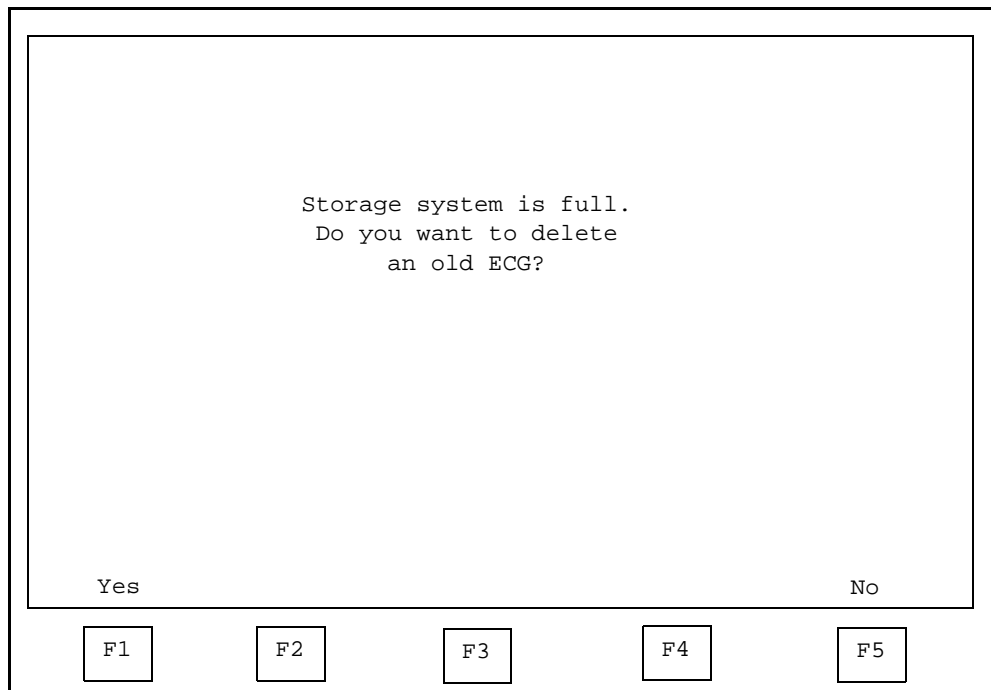

5. Press **Yes** (**F1**) to delete one or more old ECGs. The Manage Stored ECGs screen will appear. The ECGs will be listed oldest first and most recent last. See the next section, "Managing Stored ECGs", for information on deleting ECGs.

**OR**

Press **No** (**F5**) to return to the "Store ECG?" screen. Press **No** (**F5**) to continue without storing the ECG.



---

## Managing Stored ECGs

Your PageWriter 200/300pi cardiograph with Options #A05 or StressWriter allows you to print, delete, and edit the patient ID information for stored ECGs. You cannot edit the date or time the ECG was acquired, the ECG measurements, or the ECG interpretive statements.

### Selecting Stored ECGs

To select an ECG for printing, deletion, or editing the patient ID information, perform the following steps:

1. Press the  key. The main menu appears.

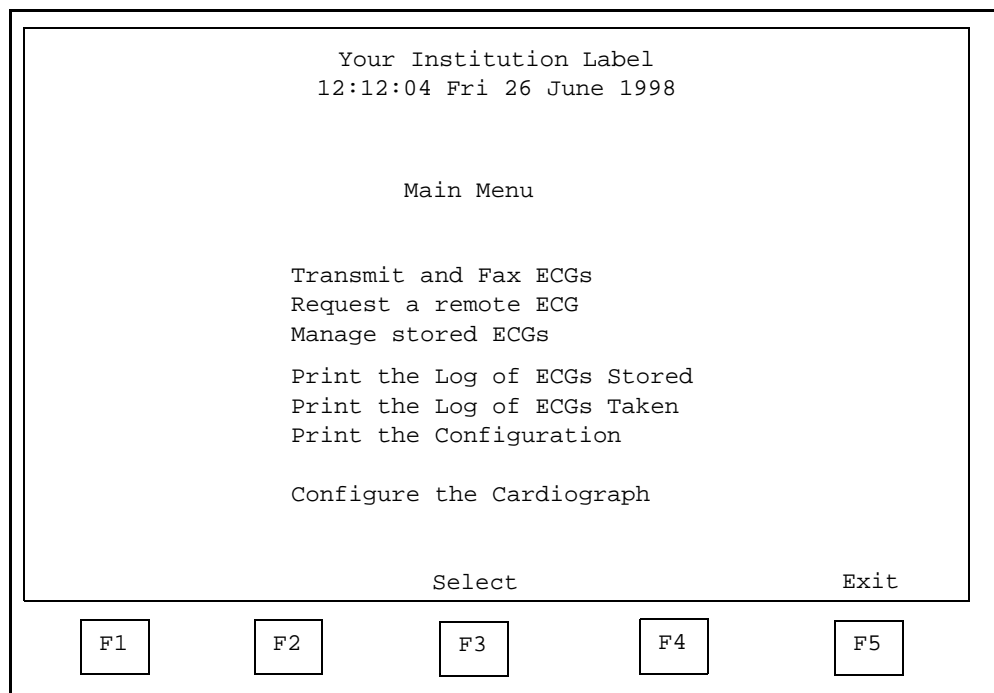

2. Select Manage Stored ECGs from the menu by pressing  or  to move the cursor down, or by pressing  or  to move the cursor up until the selection is highlighted.
3. Press **Select** () or  to display the Manage Stored ECGs menu.

Manage Stored ECGs		(30 ECGs stored)	
Screen 2 of 5			
Patient Name/ID	Time and Date		
Ian Harrison ID: 23456	00:37:58	6-Apr-98	
✓ Katharina Schmidt ID: 56321	09:17:35	9-Apr-98	
John Picard	14:53:07	9-Apr-98	
✓ Renate Desimone ID: 78654	10:34:45	11-Apr-98	
Print	Delete	Select	Edit ID
<input type="button" value="F1"/>	<input type="button" value="F2"/>	<input type="button" value="F3"/>	<input type="button" value="F4"/>
			<input type="button" value="F5"/>

4. Select the desired ECG from the list by pressing  to move the cursor down, or by pressing  to move the cursor up until the ECG is highlighted.

**NOTE**

You can move to the previous page by pressing  until ECGs from the previous page appear at the top of the screen. You can move to the next page by pressing  until ECGs from the next page appear at the bottom of the screen.

5. Press **Select** (**F3**) to select the ECG. An asterisk appears to the left of selected ECGs. The **Select** softkey changes to **Unselect** when a selected ECG is highlighted.

---

**NOTE**

---

You can select multiple ECGs to print or delete. For editing the patient ID information, you can select only one ECG at a time.

---

### **Printing Stored ECGs**

Print previously selected ECGs by pressing **Print** (**F1**). The ECGs will print with the speed and format most recently selected for printed reports. These settings are shown on the idle screen. If you want to print an ECG using a different format or speed than used on the original printed report, you can use the configuration menu or the front panel keys to change the report settings before printing. See *Configuring Your Cardiograph*, for information about changing report format and speed.

---

**NOTE**

---

The cardiograph cannot record an ECG or perform other functions while printing a stored ECG.

---

### **Deleting Stored ECGs**

Delete previously selected ECGs by pressing **Delete** (**F1**).

---

**CAUTION**

---

You **cannot** retrieve a deleted ECG.

---

## Editing Patient ID for Stored ECGs

Edit the patient ID information by performing the following steps:

1. Press **Edit ID** (**F4**). The ID Edit screen appears.

The screenshot shows a terminal window titled "ID Edit". The text inside the window is as follows:

```

ID Edit

Patient ID: 23456
Name: Ian Harrison
Age: 54 Years
Height: 180 cm
Weight: 82 Kg
Blood Pressure: 130/80
Operator:
Department:
Room:
Requested by:
Custom Field One:
Custom Field two:
Set ECG Mgmt Priority to Stat?:

Erase                                     Exit

```

Below the terminal window, there are five function key buttons labeled F1, F2, F3, F4, and F5.

2. Select the field you want to change by pressing **▼** or **▶** to move the cursor down, or by pressing **▲** or **◀** to move the cursor up until the field is highlighted.
3. Use the **Erase** key (**F1**) to remove old information.
4. Type the new information in the field.
5. When you finish making changes, press **Exit** (**F5**).

If you are using a PageWriter 300pi, the ECG will be re-interpreted and stored. The message `Analyzing...` appears on the screen during re-interpretation. The message `Storing ECG...` appears while the ECG is being stored.



---



## Printing the Log of ECGs Taken or the Log of ECGs Stored

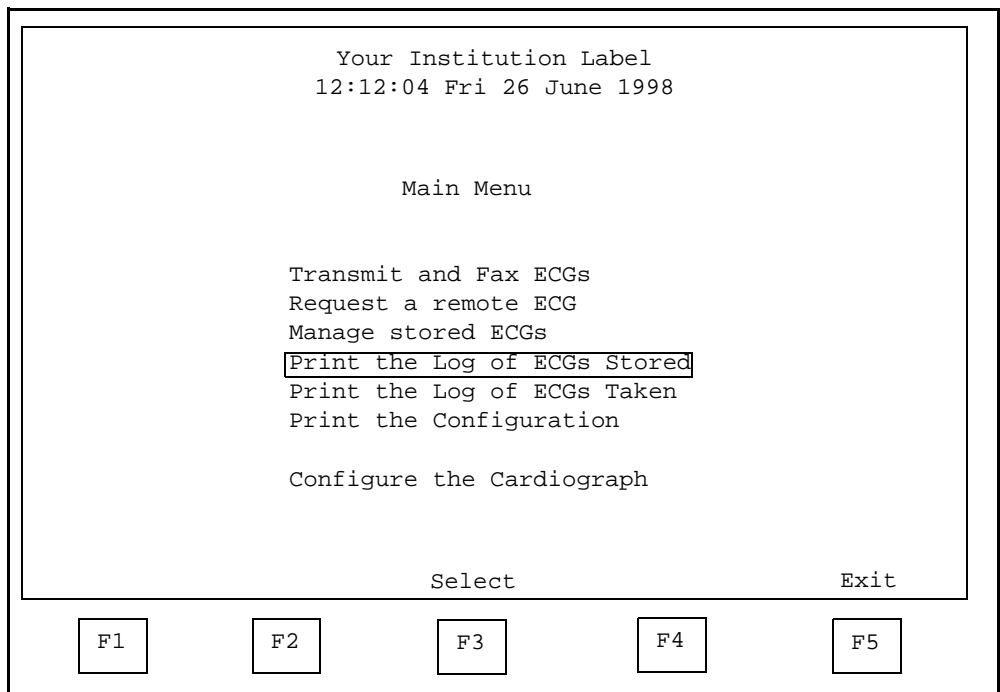

To print the Log of ECGs Taken or the Log of ECGs Stored, perform the following steps:

1. Press the  $\frac{1}{3}$   key. The main menu appears.



2. Select `Print the Log of Stored ECGs` or `Print the Log of ECGs Taken` from the menu by pressing  or  to move the

cursor down, or by pressing  or  to move the cursor up until the desired menu selection is highlighted.

3. Press **Select** () or  to print the log of ECGs taken or the log of ECGs stored

The cardiograph automatically maintains two ECG logs: the Log of ECGs Taken and the Log of ECGs Stored.

The Log of ECGs Taken is a list of the last sixty (60) Manual and Auto ECGs recorded on the cardiograph. The ECGs are listed in chronological order, with the most recent ECG first. When more than sixty (60) ECGs fill the list, the oldest ECGs disappear from the list when a new one is added.

**Figure 4-1: Log of ECGs Taken**

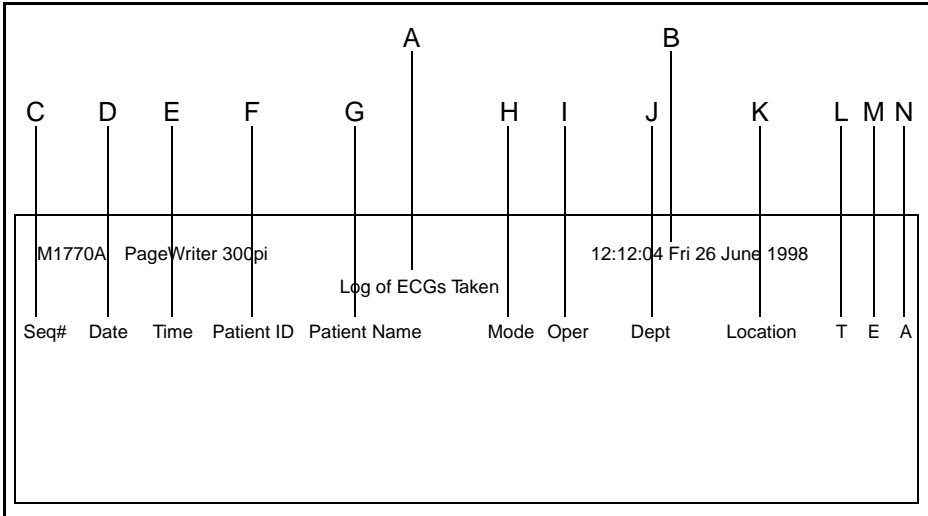

Seq#	Date	Time	Patient ID	Patient Name	Mode	Oper	Dept	Location	T	E	A
M1770A			PageWriter 300pi				12:12:04	Fri 26 June 1998			

Labels A through N point to the following fields:

- A: Patient Name
- B: Dept
- C: Seq#
- D: Date
- E: Time
- F: Patient ID
- G: Patient Name
- H: Mode
- I: Oper
- J: Dept
- K: Location
- L: T
- M: E
- N: A

**Table 4-1: The Log of ECGs Taken**

	Description
A	Log Title
B	Date and time of the report
C	Sequence number of the ECG
D	Date the ECG was taken
E	Time the ECG was taken
F	Patient identification number
G	Patient name
H	Mode used to record the ECG (Auto or Manual)
I	Person who recorded the ECG
J	Department identification number
K	Location code and cardiograph ID code
L	ECG transmitted indicator: (Y for transmitted, N for not transmitted)
M	Patient ID edit indicator (Y for edited, N for not edited)
N	Version of the criteria used to interpret the ECG

The Log of ECGs Stored lists all Auto ECGs stored in the cardiograph's internal memory. The Log of ECGs Stored is updated automatically when you store an ECG, and when you delete a stored ECG.

**Figure 4-1** Log of ECGs Stored

C	D	E	F	G	A	H	I	J	B	K	L	M	N
Seq#	Date	Time	Patient ID	Patient Name	Mode	Oper	Dept	Location	T	E	A		
M1770A	PageWriter	300pi			Lcg of ECGs Stored			12:12:04	Fri 26 June 1998				
23 ECGs stored, 7 storage spaces available													
			O		P								



**Table 4-2: The Log of Stored ECGs**

	Description
A	Log Title
B	Date and time of the report
C	Sequence number of the ECG
D	Date the ECG was taken
E	Time the ECG was taken
F	Patient identification number
G	Patient name
H	Mode used to record the ECG (Auto or Manual)
I	Person who recorded the ECG
J	Department identification number
K	Location code and cardiograph ID code
L	ECG transmitted indicator: (Y for transmitted, N for not transmitted)
M	Patient ID edit indicator (Y for edited, N for not edited)
N	Version of the criteria used to interpret the ECG
O	Number of ECGs stored
P	Number of ECG storage spaces available

## 5 Transmitting, Faxing, and Receiving Auto ECGs (Options #A05 or StressWriter only)

If your PageWriter 200/300pi cardiograph is equipped with Options #A05 or StressWriter, it can transmit and receive ECGs. The cardiograph must be configured for these functions before using them. For more information about configuring your cardiograph for transmitting and receiving ECGs, see *Configuring Your Cardiograph, and Setting Up Your Cardiograph*.

---

### Transmitting ECGs

Your PageWriter 200/300pi cardiograph can transmit Auto ECGs to another PageWriter 200, 200i or 300pi equipped with Options #A05 or StressWriter, to a PageWriter XLi cardiograph, to a TraceMaster ECG Management System, or to a Group III facsimile machine.

---

**NOTE**

---

You cannot transmit Manual ECGs. You can transmit only ECGs that have been stored.

If you are transmitting an ECG analyzed with ECL 09 criteria to a TraceMaster or ECG Manager system, you must first load the ECL 09 criteria on the receiving TraceMaster or ECG Manager system. Please contact your local Agilent Technologies representative for assistance or details on adding the ECL 09 criteria.

---

Four typical ECG transmission situations are:

- An ECG transmitted from the cardiograph at the bedside to a TraceMaster ECG Management System for printing, overreading, and storing.
- ECGs recorded on rounds and then transmitted to another PageWriter cardiograph or a TraceMaster Management System in another area of the institution.

- An ECG sent to another institution for overreading or further analysis.
- An ECG sent to a PC with ECG Manager software.

---

**NOTE**

---

If you transmit an ECG from a PageWriter 300pi with ECL 09 interpretation to either a PageWriter 200i with ECL 08 only or a TraceMaster without ECL 09 criteria, the resulting printed report will consist of ECG waveforms and measurements only.

---

---

**WARNING**

---

**Equipment connected to the cardiograph's RS-232 connector can cause ground leakage current exceeding the maximum specified in IEC 601-1 safety standards. Do not connect any equipment to the RS-232 connector during cardiograph operation when the patient cable is connected to a patient.**

---

To transmit an ECG, perform the following steps:

1. Press the  $\frac{1}{3}$   key. The main menu appears.

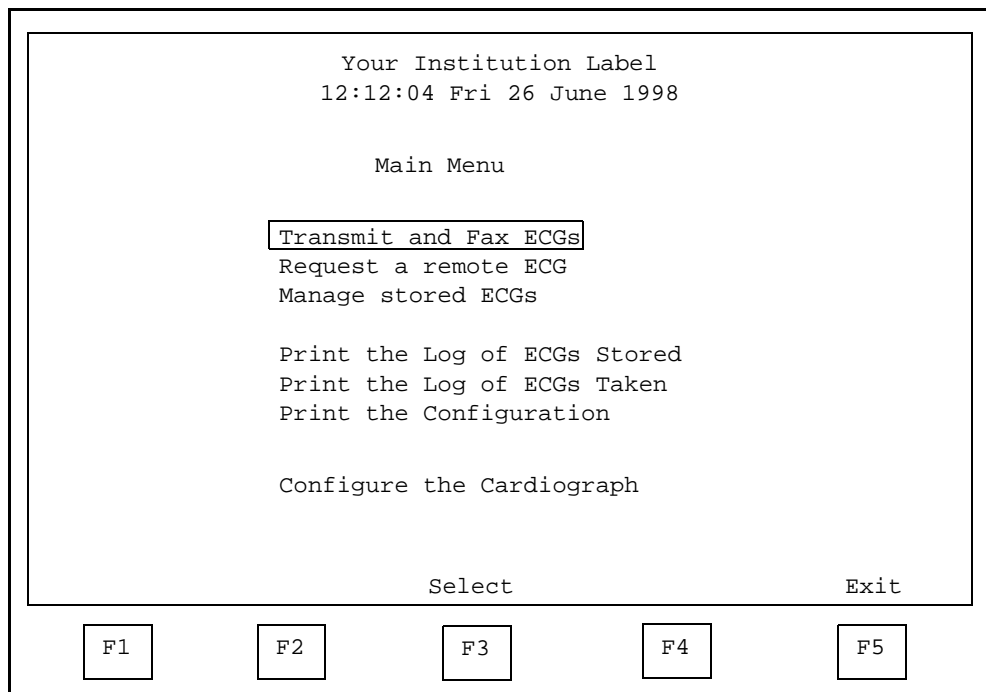

2. Select Transmit and Fax ECGs from the menu by pressing  or  to move the cursor down, or by pressing  or  to move the cursor up until Transmit and Fax ECGs is highlighted.
3. Press **Select** () or  to display the Transmit and Fax ECGs menu.

Transmit & Fax ECGs		(30 ECGs stored)	
Screen 2 of 8			
Patient Name/ID	Time and Date		
Ian Harrison ID: 23456	00:37:58	6-Apr-98	
✓ Katharina Schmidt ID: 56321	09:17:35	9-Apr-98	
John Picard ID: 45687	14:53:07	9-Apr-98	
Renate Desimone ID:78654	10:34:45	11-Apr-98	
✓ = Transmitted		* = Selected	
Select	Select All	Send New	Send ECGs
F1	F2	F3	F4
		Exit	
		F5	

- You can transmit one ECG, all ECGs, or all ECGs that have not been transmitted previously. Select one ECG from the list by pressing  to move the cursor down, or by pressing  to move the cursor up until the desired ECG is highlighted.
- Press **Select** () to select the ECG. An asterisk appears to the left of selected ECGs. The **Select** softkey changes to **Unselect** when a selected ECG is highlighted.

**OR**

Press **Select All** () to select all ECGs for transmission. The **Select All** softkey changes to **Unselect All** when all ECGs are highlighted.



## Changing a Telephone Directory Entry

You may need to add, delete, or change one of the entries stored in the telephone directory. To edit the telephone directory, perform the following steps:

1. Select **Change Entry** (F1) from the Telephone Directory menu. The softkeys will change as shown below:

Telephone Directory		
Name	Telephone Number	Type/ Speed
Dr. Moore	9W1, 555-333-1212	Modem 2400
Dr. Jones	9, 1, 555-444-1212	Fax 19200
ECG Dept		Direct 9600
Dr. Niels	P9W1, 555-666-1212	Modem 2400

Erase Done

F1 F2 F3 F4 F5

2. Select the destination to edit by pressing ▼ to move the cursor down, or by pressing ▲ to move the cursor up until the destination is highlighted. Use the ► and ◀ keys to move across the highlighted line.
3. Press **Erase** (F1) to erase the selected entry. Type the new information in the fields.

4. Type the telephone number in the second space on the line. The modem ignores spaces and hyphens in the telephone number. Use the following special symbols to specify how you want the modem to dial the telephone number:

- **comma(,):** causes the modem to pause for two seconds before continuing to dial.
- **W:** causes the modem to wait for a second dial tone before continuing to dial.  
Use this symbol if you have to dial 9, wait for a dial tone, and then dial the telephone number to place a call outside your house telephone system.
- **P:** indicates pulse dialing (with a dial), instead of tone (with a keypad).

For example, if you are using a pulse telephone with your modem, and your house telephone system requires dialing a 9 before placing an outside call, you would enter the telephone number as:

P9W555,333,4444

---

**NOTE**

---

See your modem documentation for more details on special dialing commands.

---

5. Move the cursor to the Type field. Select the transmission type by pressing **Change Type** (F3) until the appropriate transmission type appears.

See Table 5-1 for available transmission types.

The transmission type specifies the way the cardiograph will send the ECG. *Fax* specifies sending the ECG to a facsimile machine. *Modem* specifies sending the ECG over a telephone line. *Direct* specifies connecting the cardiograph to TraceMaster using a data cable. *SCP* stands for Standard Communications Protocol.

Use the following table to select the appropriate transmission type and transmission speed for the remote site.



- 
6. Move the cursor to the Speed field. Select the transmission speed by pressing **Change** (**F3**) until the appropriate transmission speed appears. See Table 5-1 for recommended transmission speed.

**Table 5-1: Remote Sites and Transmission Types**

Remote Site	Transmission Type	Recommended Speed
TraceMaster	Modem	2400
	Direct	9600
Pagewriter XLi	Modem	2400
PageWriter 200/200i/ 300pi	Modem	2400
Group III Facsimile Machine	Fax	19200
PC with ECG Manager software	ModemSCP	57600
	DirectSCP	57600

7. Press **Done** (**F5**) to save your changes and return to the previous menu.
- 

## Receiving ECGs

Your cardiograph can receive ECGs from a remote device whenever it is turned on, idle, and properly configured. If the cardiograph or modem is turned off, or if the connection speed does not match that of the sending device, the cardiograph cannot receive ECGs. You can also request transmission of an ECG from a TraceMaster ECG Management System. All ECGs are printed as they are received, using the format with which they were sent. You cannot edit, reinterpret, or store received ECGs.

### Receiving ECGs sent by a Remote Device

Your cardiograph will receive and print ECGs transmitted from a TraceMaster ECG Management system, another PageWriter 200/200i/300pi cardiograph

---

equipped with Options #A05 or StressWriter, or a PageWriter XLi, as long as it is turned on and idle. You can stop receiving the ECG at any time by pressing the  key on the front panel.

For more information on configuring your cardiograph to receive ECGs, see *Configuring Your Cardiograph*.

### **Requesting ECGs from a Remote Device**

Your cardiograph can request transmission of ECGs from a TraceMaster ECG Management system. When you request an ECG, you will receive the full ECG report, including both text and waveform. You can request an ECG from a specific remote site, for a specific patient ID. The remote site number and the patient ID are the search criteria.

To request a remote ECG, perform the following steps:

1. Press the  key. The main menu appears.

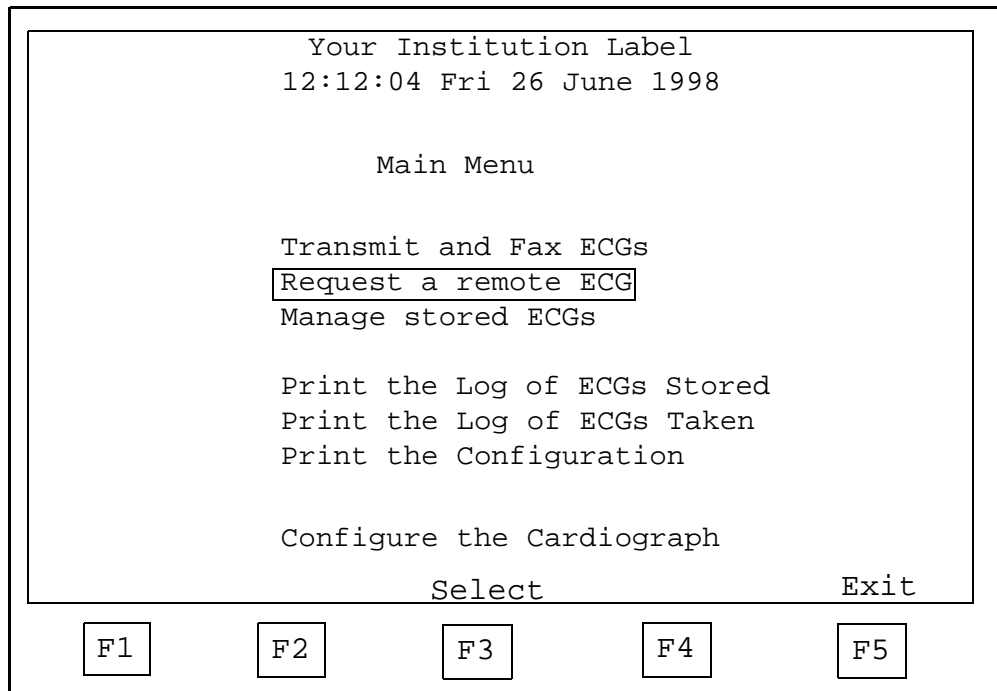

2. Select Request a Remote ECG from the menu by pressing  or  to move the cursor down, or by pressing  or  to move the cursor up until Request a Remote ECG is highlighted.
3. Press **Select** () or  to display the telephone directory. The telephone directory appears, listing up to four locations.

Telephone Directory		
Name	Telephone Number	Type/ Speed
Dr. Moore	9W1,555-333-1212	Modem 2400
Dr. Jones	9,1,555-444-1212	Fax 19200
ECG Dept		Direct 9600
Dr. Niels	P9W1,555-666-1212	Modem 2400

Change Entry                      Request                      Exit

F1                      F2                      F3                      F4                      F5

4. Press  or  to move the cursor down, or press  or  to move the cursor up until the desired location is highlighted.

**NOTE**

Although the telephone directory may contain locations with any transmission type, you can request an ECG only from locations with a transmission type of Direct or Modem.

**NOTE**

If the location from which you want to request an ECG is not in the telephone directory, you can add it. See the previous section, "Changing a Telephone Directory Entry" for information on adding or changing entries in the telephone directory.

5. Press **Request** (**F3**) or  to begin the request process. The message "Dialing <Remote Site Name>, <Remote Site Telephone Number>" appears on the screen, followed by another message "Query in progress...".
6. When communication is established between the cardiograph and the remote site, the following screen appears requesting your password:

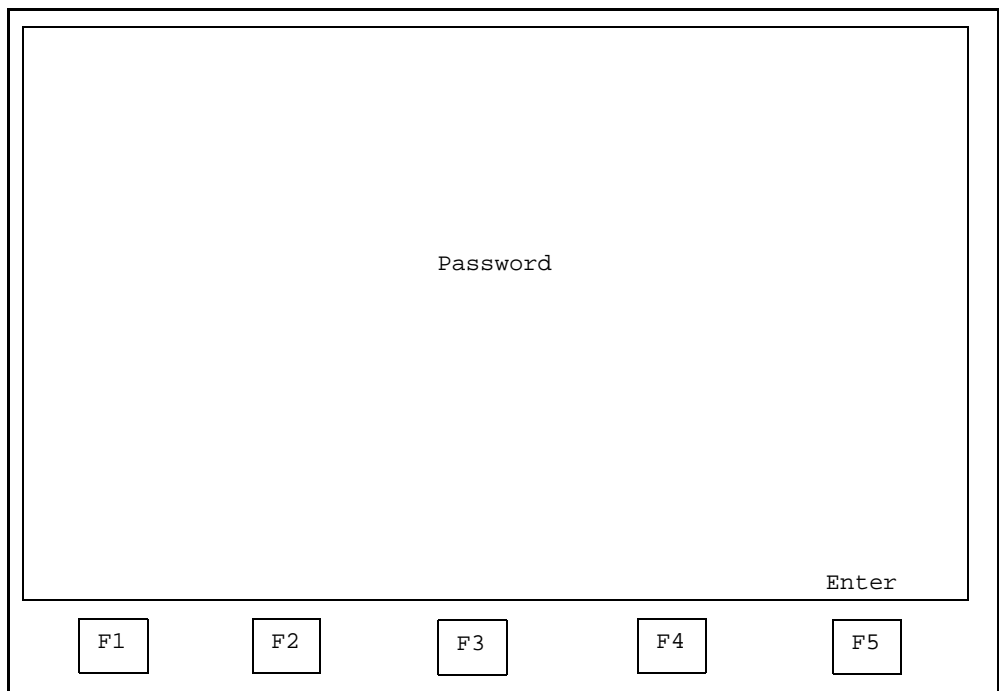

---

**NOTE**

---

See your ECG Management System systems administrator to obtain a password.

---

7. After you enter a valid password, you will be asked for the institution number. The institution number is the first three digits of the cardiograph's location code. Enter the institution number in the space provided, then press **Enter** (**F5**) or .

8. After you enter a valid institution number, you will be asked for the patient ID number. Enter the patient ID number for the desired ECG in the space provided, then press **Enter** (F5) or . The message "Searching the database, please wait..." appears on the screen during a pause. The duration of the search depends on how many ECGs are stored in the database, and how specific your search criteria are.
- If the search was unsuccessful, the following display appears:

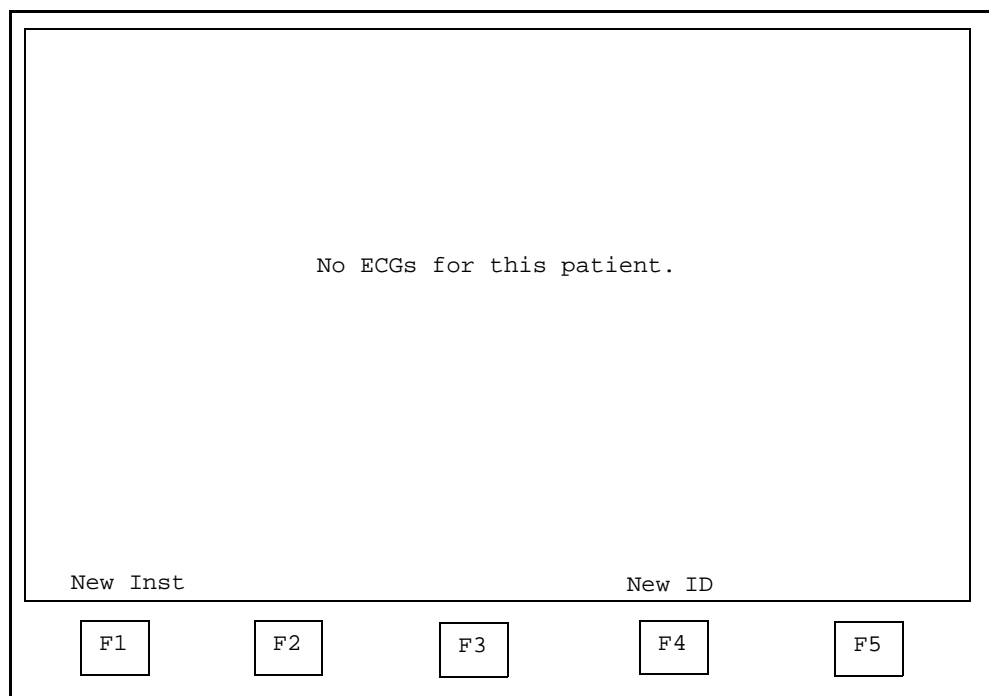

- - Press **New Inst** (F1) to return to step 2.
- - Press **New ID** (F4) to retain the institution you entered earlier, and return to step 3.

- When the search is successful, the results will be displayed on the screen as follows:

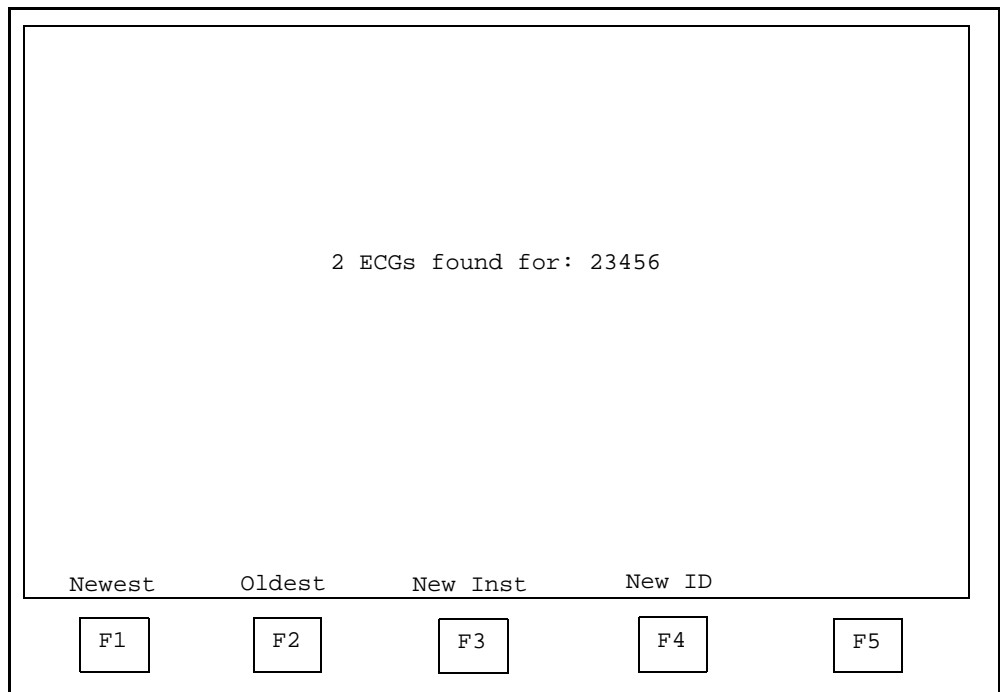

9. Press **Newest** (F1) to see the date and time of the most recent ECG found.

**OR**

- Press **Oldest** (F2) to see the date and time of the oldest ECG found.

**OR**

If you want to see an ECG that is neither oldest or newest, select either oldest or newest and use the softkeys on the next screen to locate the desired ECG.

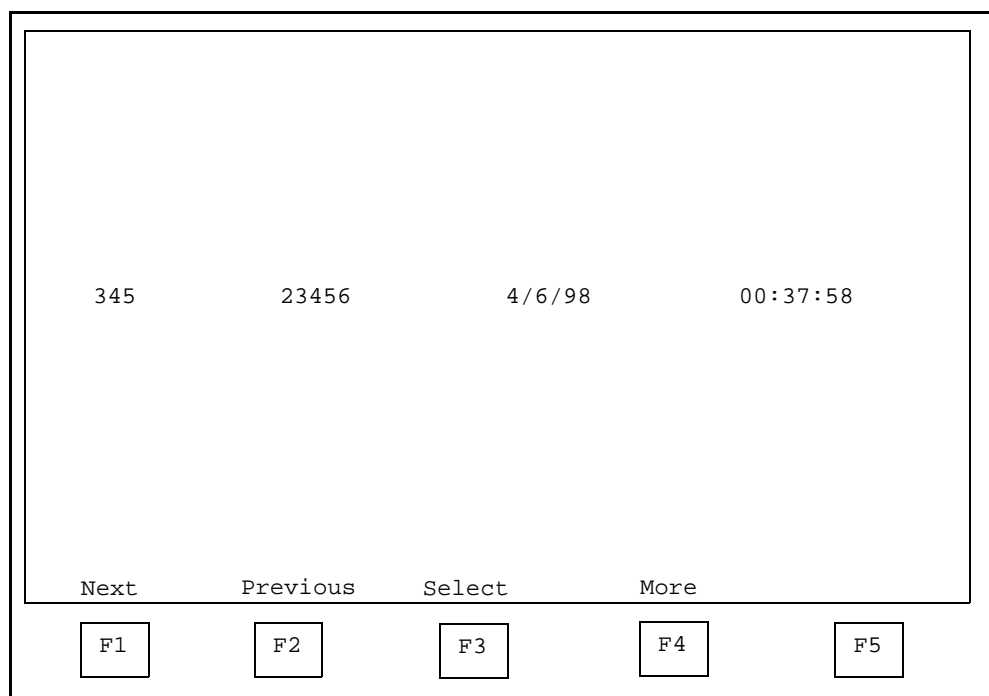

10. From this display you can scroll through a list of selected ECGs. The message line contains:

- Institution number (345)
- Patient number or the first 16 characters of the patient name (23456)



- Date and time this ECG was recorded (4/6/98 00:37:58)
11. Press **Select** (F3) to receive and print the displayed ECG. Press **Next** (F1) or **Previous** (F2) to view the other ECGs found.
  12. Press **More** (F4) to access the additional softkeys shown below:

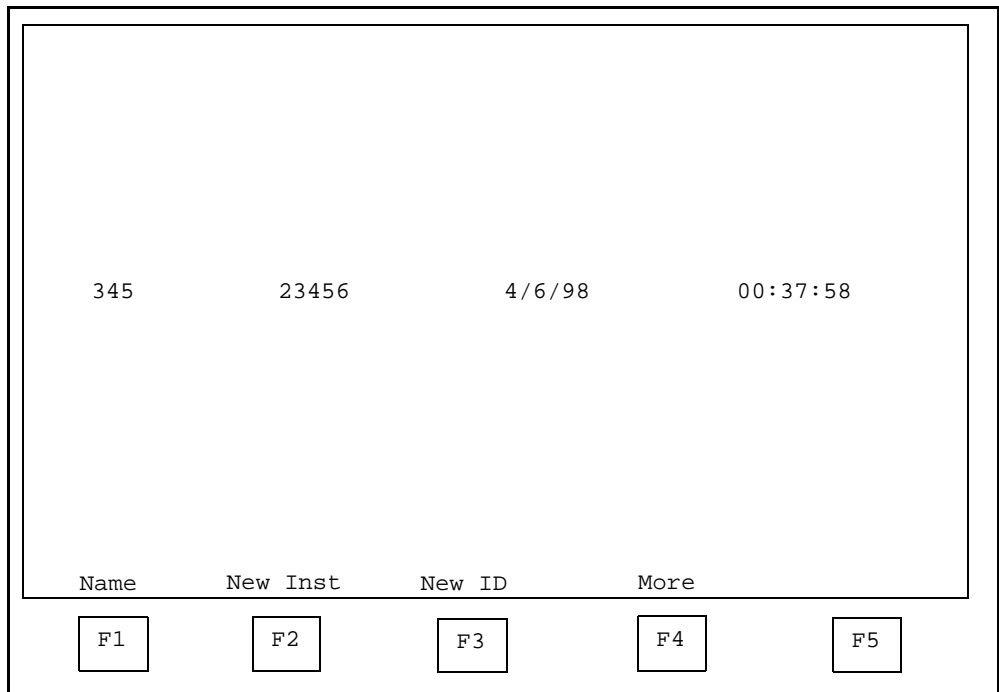

- If you wish to change the identification of the displayed ECG from patient ID number to name, press **Name** (F1). The display returns to the set of keys shown in step 9, and shows the patient name instead of the patient ID number.
- If the patient names are already displayed, you will see **ID** instead of **Name** above F1. If you wish to change the identification of the

---

displayed ECG from patient name to patient ID numbers, press **ID** (F1).

- If you wish to start a new search through another institution, press **New Inst** (F2).
- If you wish to start a new search for other patient ID numbers, press **New ID** (F3).
- If you wish to return to the set of keys shown in step 4, press **More** (F4).

You may end the interactive request session at any time by pressing the **Stop** key on the front panel. The transmission link will end immediately.

## Receiving ECGs

---

# 6 Troubleshooting

Your cardiograph is designed for reliable operation. If you have problems with an ECG, there are several things you may check before calling for service. This chapter tells how to solve basic ECG problems.

---

## Checking ECG Technique

Many problems in taking an ECG may be related to electrode application.

- Review “Preparing the Patient” in “Recording an ECG” to ensure the patient leads are properly attached to the patient.
- Refer to “Checking Signal Quality” in “Recording an ECG” for information about ensuring a good recording by using the preview screen.

A dotted line, known as a “leads off” trace will appear on the display when there is a poor connection between the electrode and the patient. Use the following table to identify and correct the connection:

**Table 6-1: Identification of Leads Off Connections**

Symptom	Check Electrode
All 12 leads show discontinuities or dashed lines	RL or N (right leg) electrode or cable wire
All leads except I show discontinuities or dashed lines	LL or F (left leg) electrode or cable wire
All leads except II show discontinuities or dashed lines	LA or L (left arm) electrode or cable wire

**Table 6-1: Identification of Leads Off Connections**

Symptom	Check Electrode
All leads except III show discontinuities or dashed lines	RA or R (right arm) electrode or cable wire
Any combination of chest (V) leads shows discontinuities or dashed line	Indicated chest (V) electrodes or cable wires



## Identifying ECG Problems

The following table shows symptoms and solutions to problems that can occur when recording an ECG.

**Table 6-2: ECG Problems and Solutions**

Problem	Cause	Possible Solutions
<p>Power line AC Interference</p> 	<p>Poor electrode contact. Dry or dirty electrodes.</p> <p>Lead wires may be picking up interference from poorly grounded equipment near the patient.</p> <p>Patient cable is too close to the cardiograph or other power cords.</p>	<p>Abrade skin. Use new electrodes. Reapply electrodes. Check expiration date on disposable electrodes.</p> <p>Route lead wires along limbs and away from other electrical equipment. Fix or move poorly grounded equipment.</p> <p>Move cardiograph away from the patient. Unplug the cardiograph and operate on battery only. Move other electrical equipment away from patient. Unplug electric bed.</p>

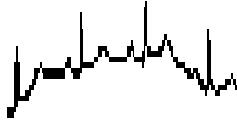
**Table 6-2: ECG Problems and Solutions (Continued)**

Problem	Cause	Possible Solutions
<p>Wandering Baseline</p> 	<p>Patient movement.</p> <p>Electrode movement. Poor electrode contact and skin preparation.</p> <p>Respiratory interference.</p>	<p>Reassure and relax the patient.</p> <p>Be sure that the lead wires are not pulling on the electrodes. Reapply electrodes. Press the <b>Filter</b> key if it is configured for Baseline Wander.</p> <p>Move lead wires away from areas with the greatest respiratory motion.</p>
<p>Tremor or Muscle Artifact</p> 	<p>Poor electrode placement. Poor electrode contact. Patient is cold.</p> <p>Tense, uncomfortable patient.</p> <p>Tremors.</p>	<p>Clean the electrode sites. Reapply electrodes. Be sure the limb electrodes are placed on flat, non-muscular areas. Warm the patient.</p> <p>Reassure and relax the patient. Press the <b>Filter</b> key if it is configured for Artifact.</p> <p>Attach the limb electrodes near the trunk. Press the <b>Filter</b> key if it is configured for Artifact.</p>
<p>Intermittent or Jittery Waveform</p> 	<p>Poor electrode contact. Dry electrodes.</p> <p>Faulty lead wires.</p>	<p>Clean the electrode site. Reapply electrodes. Check expiration date on disposable electrodes.</p> <p>Replace faulty patient cable.</p>
<p>Poor print quality (uneven contrast or blank streaks)</p>	<p>Dirty printhead.</p>	<p>Clean the printhead.</p> <p>Use recommended paper.</p>

## If the Recording Won't Start

If you press **Auto** or **Manual** and the recording doesn't start, investigate the following possibilities:

- Is the cardiograph turned on?  
The screen should be on.
- Is the AC power light on?  
If the cardiograph is plugged into AC power and the AC light is not on, check the two line fuses. See "Replacing the Fuses" in "Maintaining the Cardiograph", for fuse information.
- Is the battery adequately charged?  
The Low Battery message (in the upper-left corner of the screen) should not be displayed.
- Is the cardiograph out of paper? Is the paper jammed in the cardiograph?  
The cardiograph will not record an ECG unless you have loaded paper or cleared the paper jam. See "Maintaining the Cardiograph" for details on loading the paper. Reloading the paper will clear a paper jam.
- Is the paper sensor lens dirty or obstructed?  
Clean the paper sensor lens. See "Maintaining the Cardiograph", for more information.
- Is the paper door completely closed?  
Open the paper door slightly and close it tightly. Listen for the door safety latch to lock.
- Is there an error message?  
See "Error Messages" later in this chapter for more information.

If the cardiograph still won't operate, perform the following steps:

1. Switch the cardiograph to **Standby** (off) with the **On/Standby** switch.
2. Wait 20 seconds or more and then switch the cardiograph back to **On**.

- 
3. Press **Auto** or **Manual**. If the cardiograph turns itself to **Standby** (off), the battery is not operating properly.

If the cardiograph still won't operate, call your local Agilent Technologies service representative.

### **If the Cardiograph Won't Print a Manual Report**

- Is the paper sensor lens dirty or obstructed?  
Clean the paper sensor lens. See "Maintaining the Cardiograph" for more information.
- Is the cardiograph out of paper?  
Load paper. See "Loading the Paper" in "Maintaining the Cardiograph".

---

## **Error Messages**

The error messages that display on the screen will instruct you as to what action to take. If it is something that you can correct, the message will instruct you what to do. If an error number displays, perform the following steps:

1. Turn the cardiograph to **Standby** (off) from the front panel.
2. Wait 20 seconds or more and then turn the cardiograph on again.



## Identifying Storage Problems (Options #A05 or StressWriter only)

The following table shows symptoms and solutions to problems that can occur when storing an ECG.

**Table 6-3: Storage Problems and Solutions (Options #A05 or StressWriter only)**

Message	Likely Cause	Possible Solutions
ECG too noisy to store	<p>Poor electrode contact. Dry or dirty electrodes.</p> <p>Lead wires may be picking up interference from poorly grounded equipment near the patient.</p> <p>Patient cable is too close to the cardiograph or other power cords.</p>	<p>Use new electrodes. Abrade skin. Reapply electrodes. Check expiration date on disposable electrodes.</p> <p>Route lead wires along limbs and away from other electrical equipment. Fix or move poorly grounded equipment.</p> <p>Move the cardiograph away from the patient. Unplug the cardiograph and operate on battery power. Move other electrical equipment away from patient. Unplug electric bed.</p>
“Storage system full” message appears when fewer than 30 ECGs are stored.	<p>Storage memory gradually wears out after many thousand store/erase cycles. Consequently, ECG storage capacity decreases gradually over the life of the product.</p>	<p>If under warranty, call service. Generally, stored ECGs are retrievable. If remaining ECG storage capacity is unacceptable, call service.</p>

**Table 6-3: Storage Problems and Solutions (Options #A05 or StressWriter only)**

Message	Likely Cause	Possible Solutions
Unable to store ECG	A fault exists in the storage hardware.	Call service
Unable to retrieve ECG	A fault exists in the storage hardware.	Call service

### Identifying Transmission Problems (Options #A05 or StressWriter only)

The following table shows symptoms and solutions to problems that can occur when transmitting an ECG.

**Table 6-4: Transmission Problems and Solutions (Options #A05 or StressWriter only)**

Message	Likely Cause	Possible Solutions
Telephone busy, re-dialing	Busy telephone number.	Cardiograph will automatically re-dial, waiting 30 seconds between attempts.
No answer, re-dialing	Remote modem not connected.  Cardiograph modem is set to give up after too few rings.	Report problem to remote site.  Check configuration of modem register S7. See your modem documentation for more information.
Check telephone cable	No dial tone.	Check the connection to the telephone system. Be sure the telephone system is in operation. Replace the telephone cable.

**Table 6-4: Transmission Problems and Solutions (Options #A05 or StressWriter only)**

Message	Likely Cause	Possible Solutions
Check modem or cable	No power to modem, or poor modem cable connection.	Check that the modem is turned on. Check the data communication cable connections between the modem and the cardiograph.
Check cable	Poor cable connection between cardiograph and TraceMaster system.	Check all cable connections. Replace cable.
No modem at remote site	Remote site answered, but no modem carrier was detected, or a fax machine answered.	Verify transmission type with remote site. Check telephone number. Re-try transmission.
No fax at remote site	Remote site answered, but no fax machine was detected, or a modem answered.	Verify transmission type with remote site. Check telephone number. Re-try transmission.
Check modem configuration	Incompatible or improperly initialized modem.	Verify the modem initialization string. Refer to modem specification section in Appendix A. Verify that your modem is compatible.
Incompatible fax machine at remote site.	The fax machine at the remote site is not a group III device.	Transmission requires a group III fax machine at remote sites.

**Table 6-4: Transmission Problems and Solutions (Options #A05 or StressWriter only)**

Message	Likely Cause	Possible Solutions
Transmission stopped unexpectedly. X of N ECGs sent. Cable/modem problem. Press any key to continue.	No power to modem, or poor modem cable connection.	Check that there is power to the modem. Check the data communication cable connections between the modem, and the cardiograph. Call the other location to verify their modem is functioning correctly.
Transmission stopped unexpectedly. X of N ECGs sent. Modem was disconnected. Press any key to continue.	Problem with telephone line.	Check that the modem is connected to the telephone line. Verify that the telephone line is working.
Transmission stopped unexpectedly. X of N ECGs sent. Remote site stopped communication (nn). Press any key to continue.	Communication speed of the remote device does not match that of the cardiograph, or remote site modem malfunction.	Call the remote location to verify that the communication speed is correct and that the modem is functioning correctly. Reduce the communication speed of both the cardiograph and remote site modems.

Identifying Transmission Problems (Options #A05 or StressWriter only)

## 7 Maintaining the Cardiograph

---

### Care and Cleaning

The outside surfaces of the cardiograph and its accessories (except the patient cable) are designed to be cleaned by mild soap and water or isopropyl alcohol. The patient cable can be cleaned only with mild disinfectant or soap and water. The patient cable cannot be cleaned with isopropyl alcohol.

### Cleaning the Cardiograph

1. Unplug the power cord and ensure that the cardiograph is in **Standby** mode (the display is off).
2. Wipe the external surfaces of the cardiograph with a soft cloth dampened with mild soap and water or isopropyl alcohol. Avoid applying cleaning fluids to cable connectors.

---

#### CAUTION

---

---

**Do not** use any strong solvents or abrasive cleaning materials.

**Do not** spill any liquids on the surface of the cardiograph. Immediately have the cardiograph serviced if any liquids spill on the surface of the cardiograph.

**Do not** use the following to clean the cardiograph:

- Acetone
  - Iodine-based cleaners
  - Phenol-based cleaners
  - Ethylene Oxide Sterilization
  - Chlorine bleach
  - Ammonia-based cleaners
-

### **Cleaning the Electrodes and Cables**

Clean the electrodes and patient cables with a soft cloth moistened with a recommended disinfectant or cleaning agent from the following list:

- Cetylcide® (may discolor cable)
- Cidex®
- Lysol® Disinfectant
- Lysol® Deodorizing Cleaner (may discolor cable)
- Dial® Liquid Antibacterial Soap
- Ammonia
- 409® (may discolor cable)
- 10% solution of Clorox® in water (may discolor cable)
- Murphy® Household Cleaner, or
- Ves-phene II®.

Wring any excess moisture from the cloth before cleaning.

---

**CAUTION**

---

**Do not** clean the patient cable with alcohol. Alcohol can cause the plastic to become brittle and may cause the cable to fail prematurely.

**Do not** autoclave the cable or use ultrasonic cleaners.

**Do not** immerse the patient cable.

**Do not** use abrasive materials to clean metal surfaces—scratches on them can cause artifacts on the ECG.

**Do not** wet the connectors, especially the 15-pin connector.

---

---

## Cleaning the Digital Array Printhead and Paper Sensor

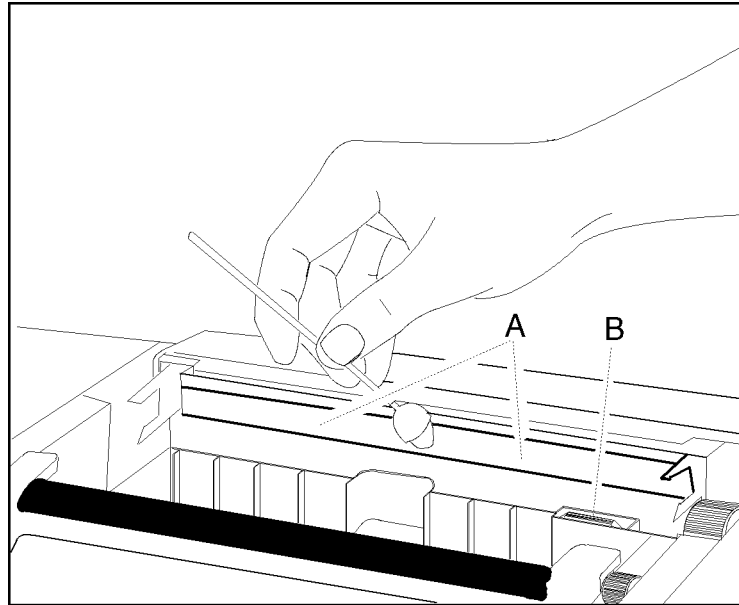

7

**Figure 7-1: Cleaning the Digital Array Printhead**

- A. Printhead
- B. Paper Sensor

If the print quality is uneven, it may be due to a dirty printhead. How frequently you must clean the printhead depends on how many ECGs you print and the quality of and type of paper you use.

If the paper fails to stop at the end of a page, the paper sensor lens may be dirty.



**To clean the printhead:**

---

**CAUTION**

---

---

Touch the equipotential connector on the back of the cardiograph to discharge any static electricity stored on your skin before touching the printhead. The printhead can be damaged by static electricity.

---

1. From the front of the cardiograph, unlatch and open the paper door. The printhead is to the right under the paper blade and behind a brush. See Figure .
2. Wipe the printhead with a foam swab dipped in 90% isopropyl alcohol. Scrub until all visible residues are removed.
3. Dry the printhead with a clean lint-free tissue.

**To clean the paper sensor lens:**

1. From the front of the cardiograph, unlatch and open the paper door. The paper sensor lens is to the right under the printhead. See Figure .
2. Lightly wipe the paper dust off of the paper sensor lens with a dry foam swab. Do not use alcohol.

## Loading the Paper

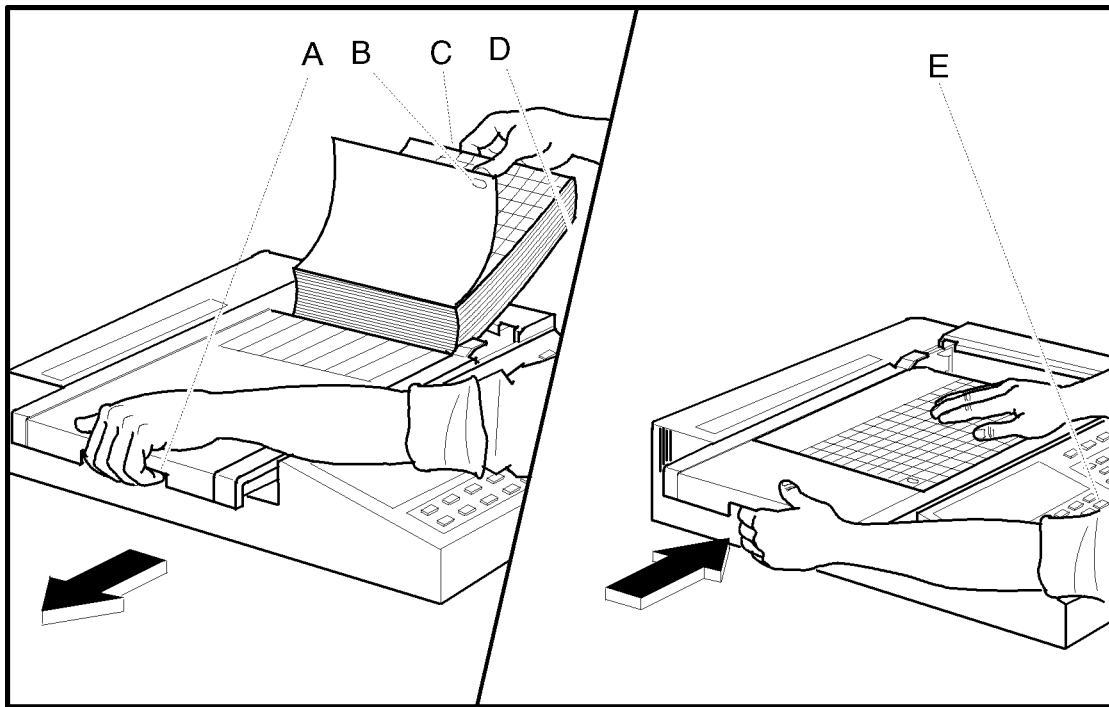

**Figure 7-2: Loading the Paper**

- A. Paper Door Latch
- B. Paper Sensing Hole
- C. Paper
- D. Cardboard Backing
- E. Page Key

The cardiograph uses continuous-feed Z-fold paper. For best results use the recommended paper. See “Supplies” later in this chapter for ordering information.

**To load the paper:**

1. From the front of the cardiograph, release the latch on the left side and slide the paper door to your left.
2. Remove the outer packaging from the paper stack.
3. Place the paper stack in the compartment so that the top side of the paper feeds grid side up over the top panel. The paper sensing hole will be in the lower corner of the paper.
4. Pull a sheet halfway out and over the paper door. Make sure that the paper lays on the black roller evenly within the channel of the paper door. See Figure 7-2.
5. Slide the paper door back into place. Make sure that the door is latched.
6. Press **On/Standby** to turn **On** the cardiograph, if necessary. Press **Page** to advance the paper to the beginning of the next page.

**Storing the Paper and Patient ECG Records**

Recordings on standard chemical/thermal paper decompose naturally over time. With proper storage and handling, recordings on these papers have been shown to be readable for approximately 5 years. Proper storage and handling before and after recording includes:

1. Storing the paper under cool and dry conditions. Temperatures must not exceed 40° C (104° F) and relative humidity must be below 80%.
2. Storing recorded ECGs in manila folders, or in sheet protectors made of polyester, polyimide, polypropylene, or acetate, in areas as described above. Do not store ECGs in vinyl sheet protectors, as noted below.

Storing the paper as indicated above will minimize trace fading and background development (darkening). However, storing the paper as indicated above does not protect against trace fading or background development from the sources below.

To avoid trace fading or background development, the paper must not be exposed to or come in contact with the following, either before or after recording:

- Solvent-based adhesives, as used in mounting forms, pressure-sensitive tapes, labels, and common mending tapes. Starch- or water-based adhesives may be used.

- 
- Plastics containing plasticizers, such as vinyl chlorides (PVC) typically found in vinyl sheet protectors, separators and plastic envelopes. Other plasticizers include polyethylene glycol, dioctyl phthalate, and dioctyl adipate.
  - Papers containing tributyl phosphate, dibutyl phthalate, or other organic solvents, such as FAX and other non-chemical/thermal recording paper, or product literature.
  - Liquid or vaporous solvents, such as alcohols, ketones, esters, ethers, etc. Note that many of these solvents are found in felt-tip and other marking pens.
  - Petroleum-based solvents, such as toluene, benzene, and gasoline.
  - Bright light or UV sources such as sunlight, fluorescent and related light sources.
  - Chemicals containing castor oil, ammonia, some chemicals found in common hand and face creams, or citric acid (found in fruit juices).
  - Forms containing carbon or carbonless (NCR) copy sheets.
  - Pastes, creams or gels commonly used for ECG or ultrasound tests that contain any of the above or related chemicals.

If original recordings are stored, it is recommended that records be checked annually to determine their integrity. However, where long term storage is desired, the user should consider photocopying or microfilming, or electronic or optical storage or a fade resistant paper.

PTP™ brand thermal papers offer improved archivability. See “Supplies” later in this chapter for ordering information.

## **Evaluating the Patient Cable**

The following procedure should be followed to detect internally shorted lead wires in the electrocardiograph patient cable. It is also recommended that the patient cable not be tightly coiled.

This test should be performed at least once each day prior to using the electrocardiograph. The test should be performed regardless of the condition of the patient cable and additionally, whenever you suspect that your patient cable may be damaged.

1. Plug the patient cable into the cardiograph.
2. Make sure the individual lead wires do not touch each other or any conductive material.
3. Switch the cardiograph to the ON position.
4. The top line of the display or top line of an AUTO recorded ECG [Printed Form] should indicate RL (AHA) or N (IEC) or RL/N (combined AHA/IEC).
5. If the top line of the display or the top line of the AUTO recorded ECG [Printed Form] shows leads other than RL, N, or RL/N, then an internally shorted lead has been detected, and the patient cable must be replaced.

---

## **Caring for the Battery**

Your cardiograph requires the battery to be installed for proper operation—even if the cardiograph is plugged into AC power, it cannot print an ECG report without the battery. For information about installing or replacing the battery, refer to *Setting Up Your Cardiograph*.

The sealed lead-acid battery used in the PageWriter 200/300pi will provide optimum life when the unit is continuously connected to AC power and fully charged after each use. A depleted battery requires 16 hours of continuous charge time to fully charge. Because it is not always possible to allow a full charge cycle between uses, the PageWriter 200/300pi was designed to charge a depleted battery to 90% of its capacity in approximately seven hours.

**CAUTION**

Repeated undercharging of the battery will damage the battery and reduce battery life.

**NOTE**

It is recommended that the cardiograph be plugged into AC power whenever possible to maximize battery life.

Battery life varies by how the battery is maintained and how much it is used. For improved battery life, keep the instrument plugged in when not in use. If the battery has been fully charged and requires recharging after a few ECGs, consider replacing it. Use only the M2460A battery.

**NOTE**

Battery should be removed from unit and placed in storage if cardiograph will not be used for more than three months without AC power.

7

**Storing the Battery**

To prepare the battery for storage, charge it in the cardiograph for 16 hours. Then remove it from cardiograph and store it in a cool, dry location. Recharge a lead-acid battery in storage for at least 16 hours every six months. This ensures that the battery does not completely discharge while in storage. The battery's shelf life is longer with cooler temperatures, but do not store below freezing level.

**Replacing the Fuses****To replace the AC fuses:**

1. Unplug the cardiograph from AC power.
2. Turn the cardiograph bottom-side up.
3. Locate the two AC fuse holders on the bottom of the cardiograph, as shown in Figure 7-3.
4. Using a screwdriver, turn the fuse cap 1/2-turn counter-clockwise. As the fuse cap is untwisted, it extends above the surface of the cardiograph case.
5. Pull the fuse cap straight up approximately 2-1/2 cm (1-inch), until it stops.

6. Remove the fuse. You may need to tap the fuse holder to shake the fuse out.
7. Insert a new fuse in the holder, slide the fuse cap back into the case. Fuse must be of the same type and rating as described on the label located next to the fuse holders.
8. Tighten the fuse cap 1/2 turn clockwise.
9. Repeat the operation for the other AC fuse.

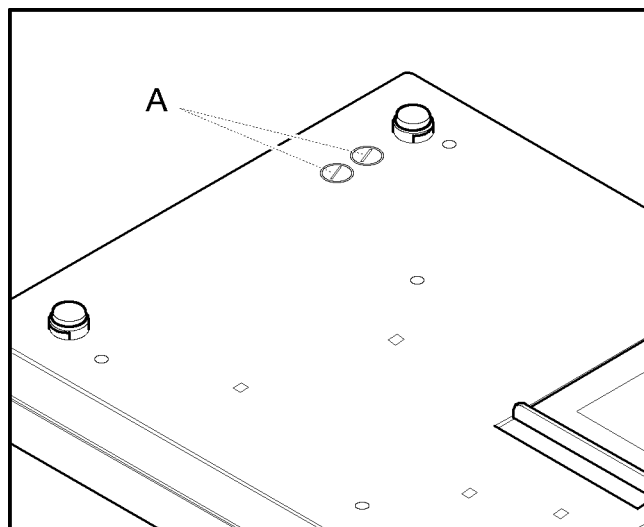

**Figure 7-3: The AC Fuse Holders**

A. AC Fuse holders (2)

---

## Supplies

A full range of cardiograph supplies is offered. The following list is a collection of the most frequently ordered items. Pricing and availability of these and other supplies are available from Agilent Technologies' Medical Supplies Centers.

- USA: Call 1-800-225-0230
- Outside USA: Please contact your local Agilent Technologies Sales Office or your authorized dealer or distributor.

### Paper

<b>M2481A</b>	Paper, 8.5" x 11", 1600 sheets, with header
<b>M2483A</b>	Paper, 210 x 300 mm, 1600 sheets, with header
<b>M2485A</b>	Paper, PTP brand Anti-fade, 8.5" x 11", 1600 sheets, with header
<b>M2486A</b>	Paper, PTP brand Anti-fade, 210 x 300 mm, 1600 sheets, with header

### Battery

<b>M2460A</b>	Battery assembly
---------------	------------------

### Patient Cable

<b>M2461A</b>	AHA Patient Cable with leads
<b>M2462A</b>	IEC Patient Cable with leads
<b>M3702A</b>	AHA Patient Cable with leads
<b>M3703A</b>	IEC Patient Cable with leads
<b>M1770-04703</b>	Patient Cable Quick Clip Storage Accessory

### Carrying Case

<b>M2463A</b>	Soft Carrying Case
---------------	--------------------



**Electrodes**

<b>40490E</b>	Welsh electrode; 15mm base 5cc bulb; screw connection (IEC)
<b>40491E</b>	Limb plate Electrode (IEC) (4 per pack)
<b>40494E</b>	Limb plate Electrode; clothespin-style (4 per pack)
<b>40421A</b>	Welsh electrodes; 15mm base 5cc bulb; push-in connection (AHA) (6 per box)
<b>40424A</b>	Limb plate electrode (AHA) (4 per pack)
<b>14030A</b>	15" Rubber strap for limb plate electrode
<b>40420A</b>	Disposable diagnostic pre-gelled electrode (1,000 pieces); snap style
<b>13943B</b>	Disposable diagnostic solid gel electrode (1,000 pieces); tab style
<b>M2253A</b>	Disposable diagnostic solid gel electrode (1,000 pieces); tab style
<b>13943D</b>	Disposable diagnostic solid gel electrode (1,000 pieces); tab style (United States and Canada only)
<b>13944B</b>	Disposable diagnostic wet gel electrode (300 pieces); snap style

**Lead Adapters**

<b>13946B</b>	Universal tab electrode adapter (10); alligator clip
<b>M2245A</b>	Universal tab electrode adapter (10)
<b>40475A</b>	Snap electrode adapter for 1/8" post leads (AHA), spring clip (10 per pkg.)
<b>40498E</b>	Grabber Electrode Adapter for 4 mm banana leads (IEC) (10 per pkg.)

**Cart**

<b>M1705B</b>	Cart
---------------	------

**Fuses**

<b>2110-0620</b>	AC fuse; T 400mA, 250 V
<b>2110-0930</b>	Battery fuse

**Service Manual**

<b>M1770-90900</b>	Service Manual
--------------------	----------------

**Data Communications**

Several modem and cabling solutions are available from Agilent.  
Refer to the PageWriter 200/300pi sales literature.

---

## Calling for Service

For telephone assistance, call the Response Center nearest to you, or visit our website at: [www.hp.com/go/medservices](http://www.hp.com/go/medservices).

### United States of America

**Medical Response Center** Tel: (800) 548-8833

### Canada

#### Eastern Region

Tel: (800) 361-9790

#### Central & Western Regions

Tel: (800) 268-1221

### Other International Areas

#### Australia

Tel: 131147

#### France

Tel: 0803 35 34 33

#### Germany

Tel: 0130-4730

#### Italy

Tel: 0292 122999

#### Netherlands

Tel: (0) 20-547-6333

#### United Kingdom

Tel: 44-344-36633

#### Belgium

Tel: 32 2 778 35 31

# A Setting Up Your Cardiograph

Before using your cardiograph for the first time you must prepare it by performing the following tasks:

- Check the voltage setting
- Install the battery
- Connect the power and patient cables
- Load the paper

Also, performing the following tasks is strongly recommended:

- Set the keyboard to uppercase or lowercase mode
- Set the cardiograph location and ID codes (Options #A05 or Stress-Writer only)
- Connect the modem and transmission cables (Options #A05 or Stress-Writer only)
- Setup the telephone directory for transmitting and receiving ECGs (Options #A05 or StressWriter only)
- Set the Predictive Instruments application (PageWriter 300pi only)

In addition, you may want to configure the cardiograph to suit your specific application. See *Configuring Your Cardiograph* for more information.

---

## Checking the Voltage Setting

Your cardiograph can be set to operate at a nominal line voltage of 115 or 230 Volts (see the following **Note**). The line voltage was set at the factory to the setting for your area. However, it is a good idea to check this setting before operating the cardiograph. To check the voltage setting, perform the following steps.

1. Locate the voltage select switch on the back of the cardiograph. See Figure A-1 for the location of the switch.

2. Verify that the correct voltage is visible on the voltage select switch. If the voltage setting is incorrect, slide the voltage switch so the correct voltage is visible. The cardiograph operates with a line frequency of either 50 or 60 Hz.
3. Remove and discard the label covering the AC power receptacle. See Figure A-1 for the location of the AC power receptacle. You are required to remove the label as a reminder to check the setting of the voltage select switch.

---

**CAUTION**

The cardiograph can be damaged if plugged into the incorrect voltage.

---

---

**NOTE**

The nominal 115 VAC voltage setting works for any voltage between 100–120 VAC. The nominal 230 VAC voltage setting works equally well for any voltage between 220–240 VAC.

---

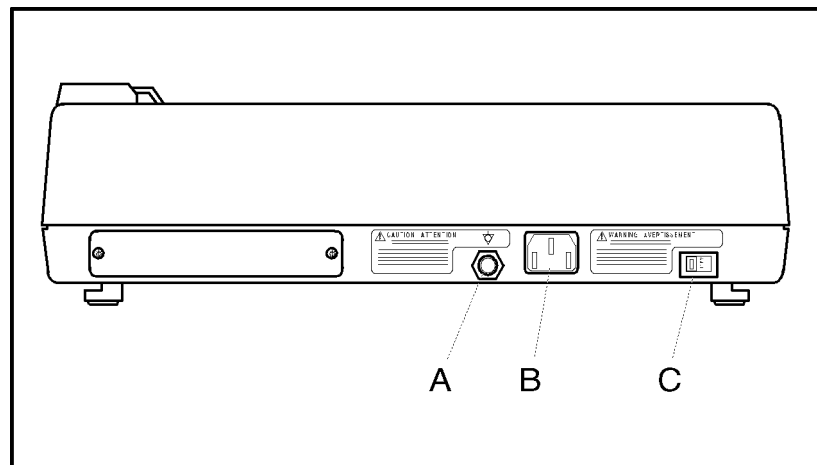

**Figure A-1: Rear View of Cardiograph**

- A. Equipotential Connector
- B. AC Power Receptacle
- C. Voltage Select Switch

---

**NOTE**

---

---

The equipotential connector is used when the cardiograph must be plugged into an ungrounded outlet. See Patient and Operational Safety Notes in Getting Acquainted for more information about using the equipotential connector.

---

---

## The Battery

Your cardiograph requires the battery to be installed for proper operation—even if the cardiograph is plugged into AC power. The cardiograph cannot operate without the battery.

Use only part number M2460A batteries in the cardiograph.

### Installing the Battery

#### To Install the Battery:

---

**NOTE.**

---

---

Do not remove the shrinkwrap surrounding the battery.

---

1. Make sure the cardiograph is unplugged from AC power.
2. Turn the cardiograph bottom-side up.
3. Slide the battery door in the direction of the arrow shown in Figure A- until it unlatches (approximately 1/2 inch). Lift off the door.
4. Install the new battery in the battery compartment as shown in Figure A- and plug the battery connector into the cardiograph.
5. Place the battery door into its slots and slide the door in the opposite direction of the arrow shown in Figure A-2 until it latches.
6. Turn the cardiograph top-side up.
7. Plug the cardiograph into AC power.
8. Check that the AC indicator light is on. The unit is now in **Standby** (off) mode with the battery charging.

After you finish setting up the cardiograph, it may be used on a limited basis until the battery is fully charged. Charging the battery as soon as possible for

at least 16 hours is recommended. To charge the battery, plug the cardiograph into the wall outlet with the **On/Standby** switch set to **Standby** (off).

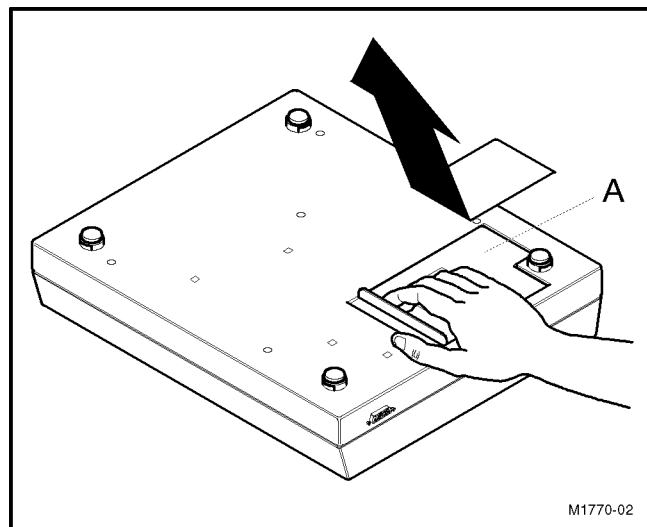

**Figure A-2: Removing the Battery Door.**

A. Battery Door

## Removing the Battery

### To Remove the Battery:

1. Make sure the cardiograph is unplugged from AC power.
2. Turn the cardiograph bottom-side up.
3. Slide the battery door in the direction of the arrow shown in Figure A-2 until it unlatches (approximately 1/2 inch). Lift off the door.
4. Unplug the battery connector from the cardiograph by squeezing the edges of the connector and pulling it straight out.
5. Remove the battery and cable.
6. If the battery has been removed for storage, replace the battery cover by placing the battery door into its slots and sliding the door in the opposite direction of the arrow shown in Figure A-2 until it latches.

---

---

**WARNING**

---

---

Properly dispose of or recycle depleted batteries according to local regulations. Do not disassemble, puncture or incinerate the depleted batteries.

---

---

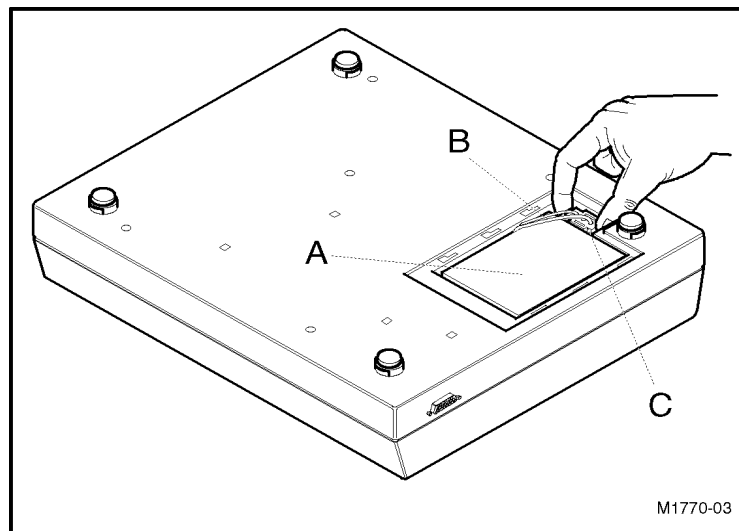

**Figure A-3: The Battery Compartment.**

- A. Battery
- B. Battery Cable
- C. Battery Connector



---

## Connecting the Cables

1. Plug the power cord into the wall outlet.
2. Connect the power cord to the cardiograph as shown in Figure A-4.

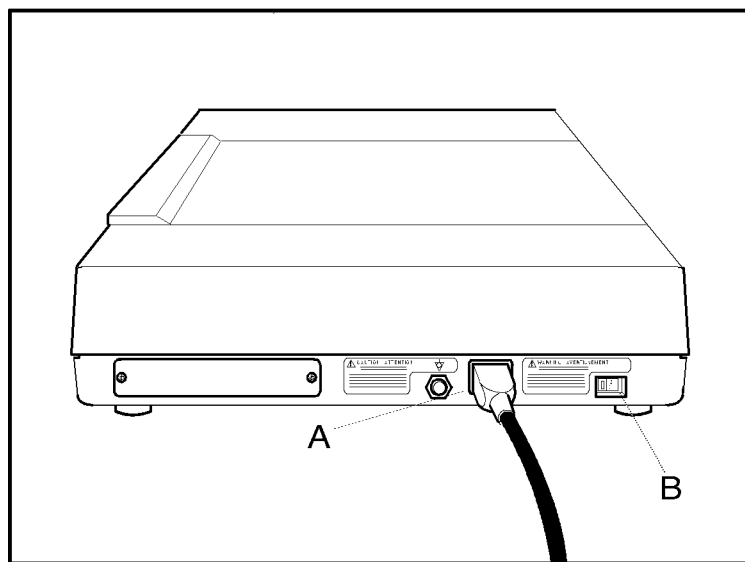

**Figure A-4: Connecting the Power Cord.**

- A. Power Cord
- B. Voltage Select Switch

---

### WARNING

**If you must use an ungrounded plug adapter to plug the power cord into the wall outlet, you must also use a ground strap to connect the equipotential connector at the rear of the cardiograph to the power source ground.**

**Figure A-1 shows the location of the equipotential connector. Refer to the Patient and Operational Safety Notes in Getting Acquainted for more information about using the equipotential connector.**

---

Connect the Patient cable to the front of the cardiograph as shown in Figure A-5 and screw in both thumbscrews.

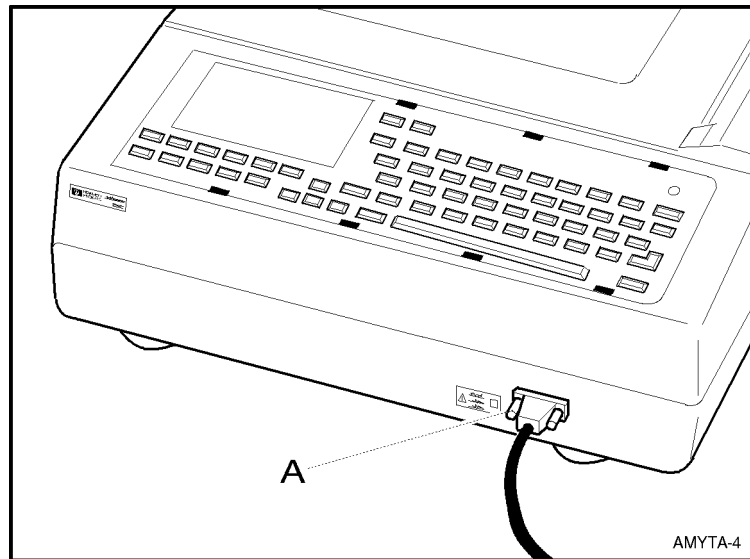

**Figure A-5: Connecting the Patient Cable.**

A. Patient Cable



---

## Loading Paper

For the best results, use only the recommended paper. See Supplies in Maintaining the Cardiograph for ordering information. The cardiograph uses continuous feed Z-fold paper.

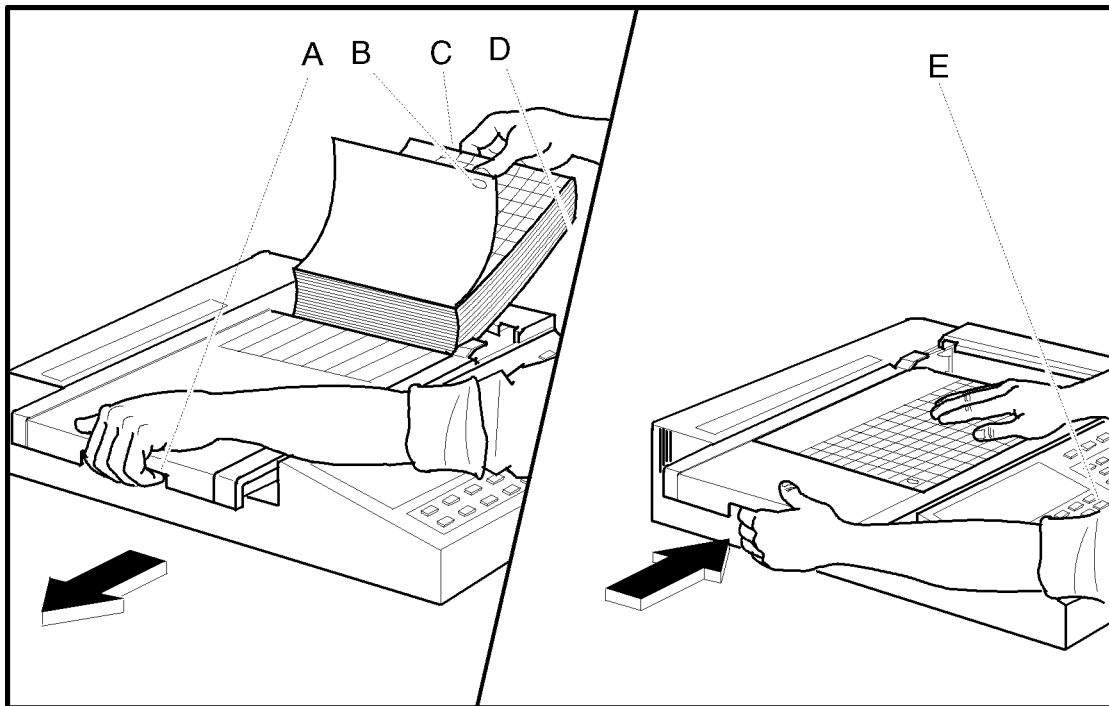

**Figure A-6: Loading the Paper**

- A. Paper Door Latch
- B. Paper Sensing Hole
- C. Paper
- D. Cardboard Backing
- E. Page Key

**To load the paper:**

1. From the front of the cardiograph, release the latch on the left side and slide the paper door to your left.
2. Remove the outer packaging from the paper stack.
3. Place the paper stack in the compartment so that the top side of the paper feeds grid side up over the top panel. The paper sensing hole will be in the lower right corner of the paper.
4. Pull a sheet halfway out and to your left over the paper door. Make sure that the paper lays on the black roller evenly within the channel of the paper door. See Figure A-6.
5. Slide the paper door back into place. You will hear a sharp click when the door is properly latched.
6. If the cardiograph is not on, press the **On/Standby** key to turn the unit on.
7. Press **Page** to advance the paper to the beginning of the next page.

**Setting the Keyboard Mode**

The keyboard mode is initially set to lowercase. You can change the keyboard mode from lowercase to uppercase (and vice versa) by performing the following steps.





1. Press the  $\frac{1}{3}$  **☰** key. The Main Menu appears.
  2. Press the **▼** key until the **Setup Miscellaneous** selection is highlighted.
- OR
3. If your cardiograph is equipped with Options #A05 or StressWriter, press the **▼** key until the **Configure the Cardiograph** selection is highlighted. Press the **▼** key until the **Setup Miscellaneous** selection is highlighted.
  4. Press the **Select** (**F3**), or **←** key. The **Setup Miscellaneous** menu appears.
  5. Press the **▼** key to highlight the current keyboard mode.
  6. Press **Change** (**F3**) to toggle between **UPPER** and **lower**.

7. Press **Exit** (**F5**) to save your selection.

---

## Setting the Cardiograph Location and ID Codes (Options #A05 or StressWriter only)

The cardiograph location and ID codes should be set before transmitting or receiving ECGs. These codes are assigned by your a TraceMaster ECG Management System systems administrator.

1. Press the  $\frac{1}{3}$   key. The Main Menu appears.
2. Press the  key until the Configure the Cardiograph selection is highlighted.
3. Press the **Select** (**F3**) key, or the  key. The Setup Miscellaneous menu appears.
4. Press the  key to highlight the cardiograph location code.
5. Enter the five digit numeric code.
6. Press the  key to highlight the cardiograph ID code.
7. Enter the four digit numeric code.
8. Press **Exit** (**F5**) to save your selection.

---

## Connecting the Direct Transmission Cable (Options #A05 or StressWriter only)

You can transmit ECGs directly by cable to an a TraceMaster ECG Management System, or a PC. Connect the transmission cable as shown in Figures A-7, A-8, and A-9, and screw in both thumbscrews.

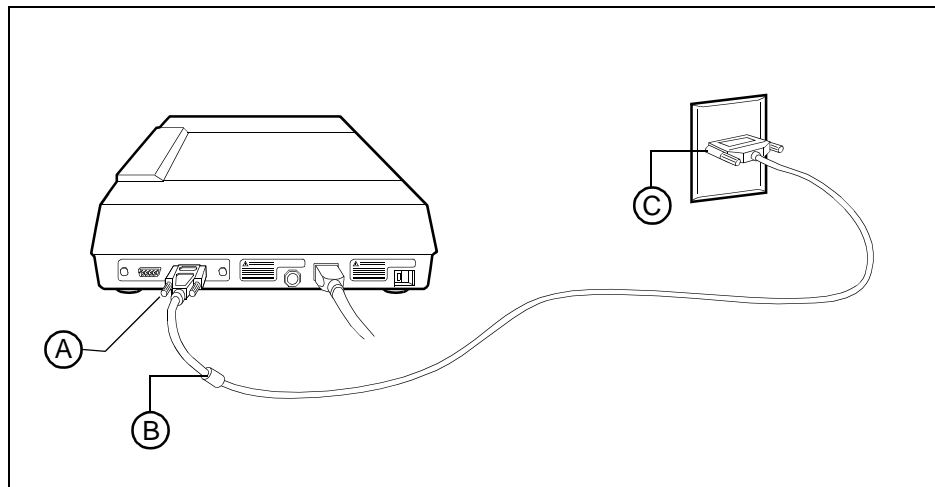
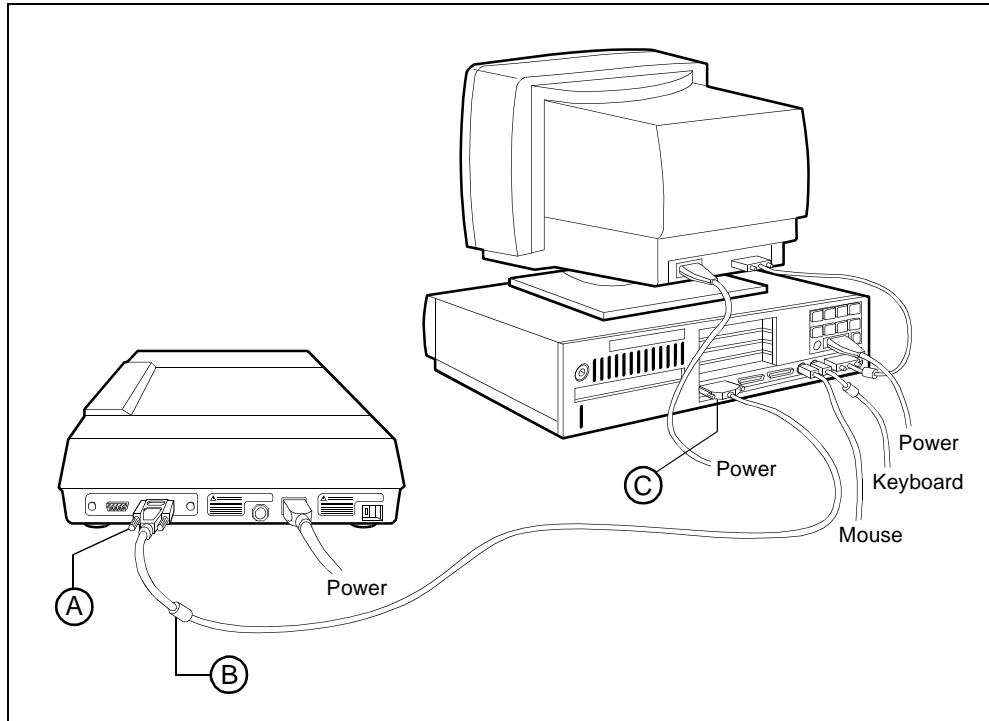

**Figure A-7: Connecting the Direct Transmission Cable to TraceMaster**

- A. PageWriter 200/300pi cardiograph connection
- B. Transmission cable (DB9F/DB25M serial modem cable<sup>1</sup>)
- C. TraceMaster ECG Management System connection

---

1. Quick-disconnect cabling is available from Agilent Technologies. Refer to the PageWriter 200/300pi sales literature.



**Figure A-8: Connecting the Direct Transmission Cable to a PC**

- A. PageWriter 200/300pi cardiology connection
- B. Transmission cable (DB9F/DB9F null modem cable<sup>1</sup>)
- C. PC connection

---

1. Quick-disconnect cabling is available from Agilent Technologies. Refer to the PageWriter 200/300pi sales literature.

---

## **Transmitting or Faxing ECGs by Modem (Options #A05 or StressWriter only)**

You can also use a modem to transmit or fax ECGs by telephone to any of the following:

- PageWriter XLi cardiograph
- PageWriter 200/200i/300pi cardiograph
- TraceMaster ECG Management System
- ECG Manager
- Group III fax machine

A



Before using the M1706B modem, you must connect the cables. Figure A-9 shows how to connect the cables for transmitting ECGs using a modem.

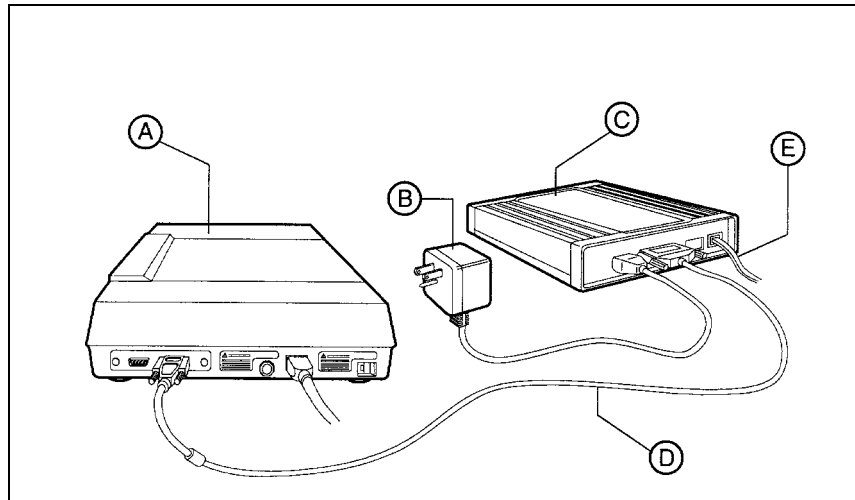

**Figure A-9: Connecting the Modem Cables**

- A. PageWriter 200/300pi cardiograph
- B. Modem power cord
- C. Modem (M1706B, U.S. only application)
- D. Modem data cable (DB9F/DB25M serial modem cable<sup>1</sup>)
- E. Phone line connector

---

**NOTE**

---

The following instructions support only the M1706B, U.S. only modem. In all other cases, you must consult the instructions for your locally purchased, country specific modem.

---

To setup the cardiograph for transmission, refer to Figure A-9 and perform the following steps:

1. Turn the cardiograph off.

- 
1. Quick-disconnect cabling is available from Agilent Technologies which allows you to quickly switch between connection to a modem and direct connection to a TraceMaster, PC or another cardiograph. Refer to the PageWriter 200/300pi sales literature.

2. Turn the modem power switch off.
3. Insert the 9-pin female subminiature D connector end of the modem data cable into the RS-232 connector on the back of the cardiograph.
4. Refer to your modem manual for instructions on connecting the modem to the modem data cable, the modem power cable, and the telephone line.
5. Turn the modem on.
6. Turn the cardiograph on.

---

**WARNING**

---

---

**Equipment connected to the cardiograph's RS-232 connector can cause ground leakage current exceeding the maximum specified in IEC 601-1 safety standards. Do not connect any equipment to the RS-232 connector during cardiograph operation when the patient cable is connected to a patient.**

---

---

## **Setting Up the Telephone Directory (Options #A05 or StressWriter only)**

To transmit or receive ECGs from a remote site, you must identify the remote site, its telephone number and the type of transmission the cardiograph should send or receive. You can enter the telephone numbers of up to four remote sites in the directory. To setup the telephone directory, perform the following steps:

1. Select `Setup Telephone Directory` from the configuration menu. The telephone directory appears with four lines for entering remote site telephone numbers and transmission types.

A

Setup Telephone Directory		
Name	Telephone Number	Type/ Speed
1.		
2.		
3.		
4.		
Erase	Change Type	Exit

F1      F2      F3      F4      F5

2. Add the name and telephone number by pressing  or  to move the cursor to a blank entry line.
3. Type the name in the first space on the line. Use the  and the  keys to move along the line.
4. If you are using Direct or Direct SCP transmission, leave the telephone number blank. For other transmission types, type the telephone number in the second space on the line. The modem ignores spaces and hyphens in the telephone number. Use the following special symbols to specify how you want the modem to dial the telephone number:
  - **comma(,):** causes the modem to pause for two seconds before continuing to dial.
  - **W:** causes the modem to wait for a second dial tone before continuing to dial. Use this symbol if you have to dial 9, wait for a dial tone,

---

and then dial the telephone number to place a call outside your house telephone system.

- **P:** indicates pulse dialing (with a dial), instead of tone (with a keypad).

For example, if you are using a pulse telephone with your modem, and your house telephone system requires dialing a 9 before placing an outside call, you would enter the telephone number as:

P9W555,333,4444

---

**NOTE**

---

---

See your modem documentation for more details on special dialing commands.

---

5. Move the cursor to the Type field. Select the transmission type by pressing **Change Type** ( **F3** ) until the appropriate transmission type appears.

The transmission type specifies the way the cardiograph will send the ECG. *Fax* specifies sending the ECG to a facsimile machine. *Modem* specifies sending the ECG over a telephone line. *Direct* specifies connecting the cardiograph to TraceMaster using a data cable. *SCP* stands for *Standard Communications Protocol*.

6. Move the cursor to the Speed field. Select the transmission speed by pressing **Change** ( **F3** ) until the appropriate transmission speed appears. See Table A-1 for recommended transmission speeds.



**Table A-1: Remote Sites, Transmission Types, and Recommended Speeds**

Remote Site	Transmission Type	Recommended Speed
TraceMaster	Modem	2400
	Direct	9600
Pagewriter XLi	Modem	2400
PageWriter 200/200i/ 300pi	Modem	2400
Group III Facsimile Machine	Fax	19200
PC with ECG Manager software	ModemSCP	57600
	DirectSCP	57600

7. Press **Exit** (**F5**) to save the directory and return to the Configuration menu.

## Setting Up Predictive Instruments

Your PageWriter 300pi contains Predictive Instrument software applications which generate 0-100% predicted probability scores of Acute Cardiac Ischemia (ACI) and patient outcome, with and without thrombolytic therapy, for Acute Myocardial Infarction (AMI). Additional information on the Predictive Instrument applications can be found in “Understanding the ECG Analysis Program”.

This manual briefly describes the steps to configure the cardiograph for Predictive Instruments. Please refer to the *Predictive Instruments Physician’s Guide* for further details of the Acute Cardiac Ischemia - Time Insensitive Predictive Instruments (ACI- TIPI) and the Thrombolytic Predictive Instrument (TPI) applications.

1. Select ‘Setup Predictive Instruments’ from the configuration menu. Here you can enable ACI- TIPI and the ACI-TIPI risk management report, as well as define the ACI-TIPI probability limits to generate the Risk Management Report.
2. This menu also allows you to enable the Thrombolytic Predictive Instrument, enable the Acute Myocardial Infarction screening, and specify the Interpretation Criteria.
3. Press the **Change** ( **F3** ) to select the settings that you want enabled. Use the (arrow keys) to move to the next question.
4. If a Risk Management Report is desired, type in the upper and lower limits of the ACI-TIPI scores for which a Risk Management Report is desired. If the ACI-TIPI score falls between these limits, the Risk Management Report will be printed.

**Table A-2: Risk Management Report Parameters**

Parameter	Choices <sup>a</sup>	Comments
Enable ACI-TIPI Analysis?	Yes/ <b>No</b>	
Enable Risk Management Report?	Yes/ <b>No</b>	Only available with ACI TIPI enabled
Low Limit for Risk Mgmt Report (0-100)?	20%	

**Table A-2: Risk Management Report Parameters**

Parameter	Choices <sup>a</sup>	Comments
High Limit for Risk Mgmt Report (0-100)?	80%	
Enable TPI Analysis?	Yes/No	
Enable Automatic AMI Detection?	Yes/No	Only available with TPI enabled
Print All TPI Reasons?	Yes/No	
Interp Criteria?	<b>Default</b>  Adult  Pediatric  ACI-TIPI  TPI  08/TIPI	— ‘Default’ prints reports according to the above settings — Std Adult 09 report without TPI or ACI TIPI — Std Pediatric P4 report without TPI or ACI TIPI — ACI TIPI Analysis, with optional Risk Management Report depending on user configurable low and high limits — TPI Analysis with AMI detection — Std Adult T8 report with ACI TIPI <sup>b</sup>

a. Default values are shown in boldface font.

b. The ACI TIPI analysis can be disabled to produce a standard Adult 08 report by setting the ‘Chest/LA Pain’ entry on the Setup ID entry menu to ‘No.’

- Press **Exit** ( **F5** ) to save the configuration and return to the Configuration menu.

## B Configuring Your Cardiograph

Your cardiograph may be customized, or configured, to meet your particular requirements. This chapter describes how to configure your cardiograph and print out your configuration settings.

---

**NOTE**

---

---

The cardiograph maintains its configuration information in non-volatile memory—this means your configuration cannot be accidentally erased by discharging or removing the battery or AC power.

---



---

## The Configuration Menu

The Configuration menu allows you to choose the screens from which you can set your cardiograph's configuration. Each configuration menu choice is described briefly in a list, then each is described in more detail in the sections that follow. Default configuration settings are also listed in the tables.

Press  $\frac{1}{3}$   to display the Main Menu screen.. The following screen will appear: (On PageWriter 200 models, the reference to the set up of predictive instruments is not included.)

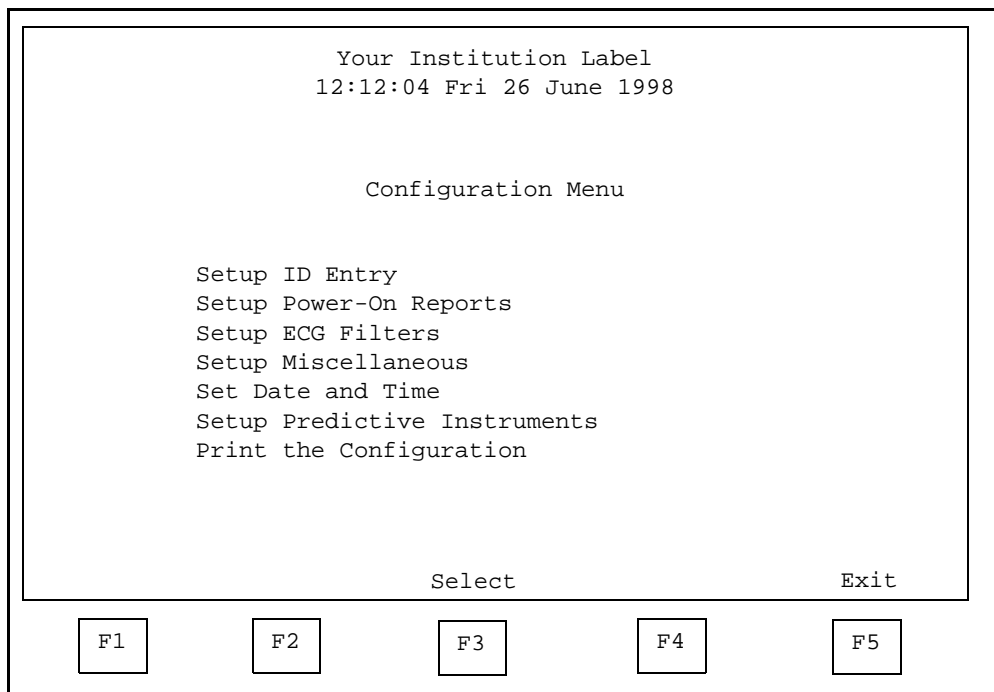



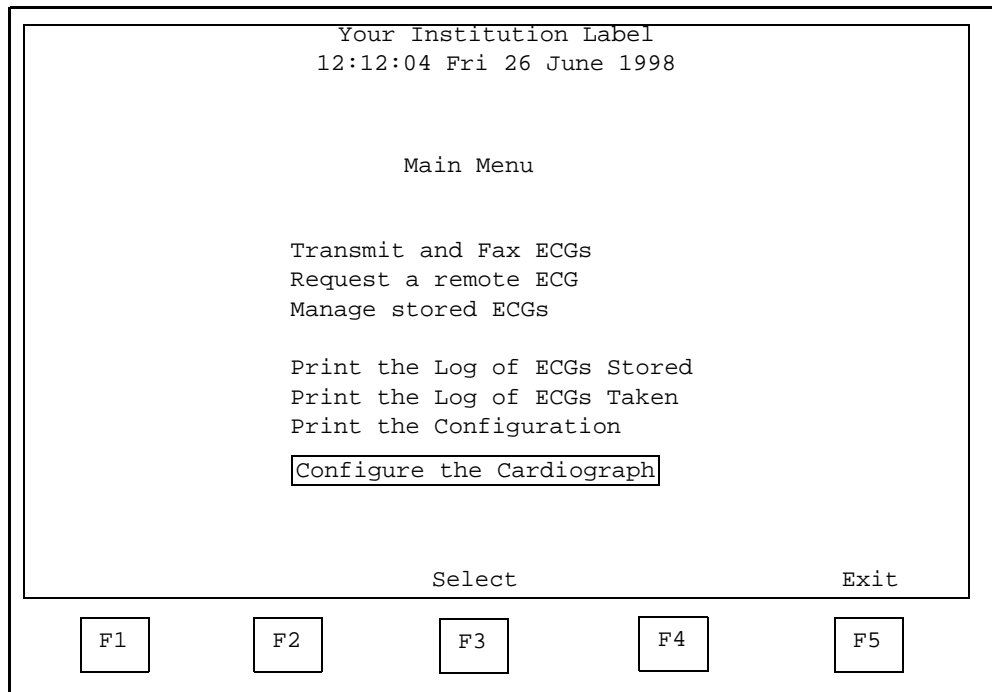

If you have a PageWriter 200 or 300pi with Options #A05 or StressWriter, this screen will appear:



## The Configuration Menu

---

1. Select Configure the Cardiograph from the menu by pressing  or  to move the cursor down, or by pressing  or  to move the cursor up until Configure the Cardiograph is highlighted.
2. The Configuration Menu appears. (On PageWriter 200 models, the reference to the set up of predictive instruments is not included.)

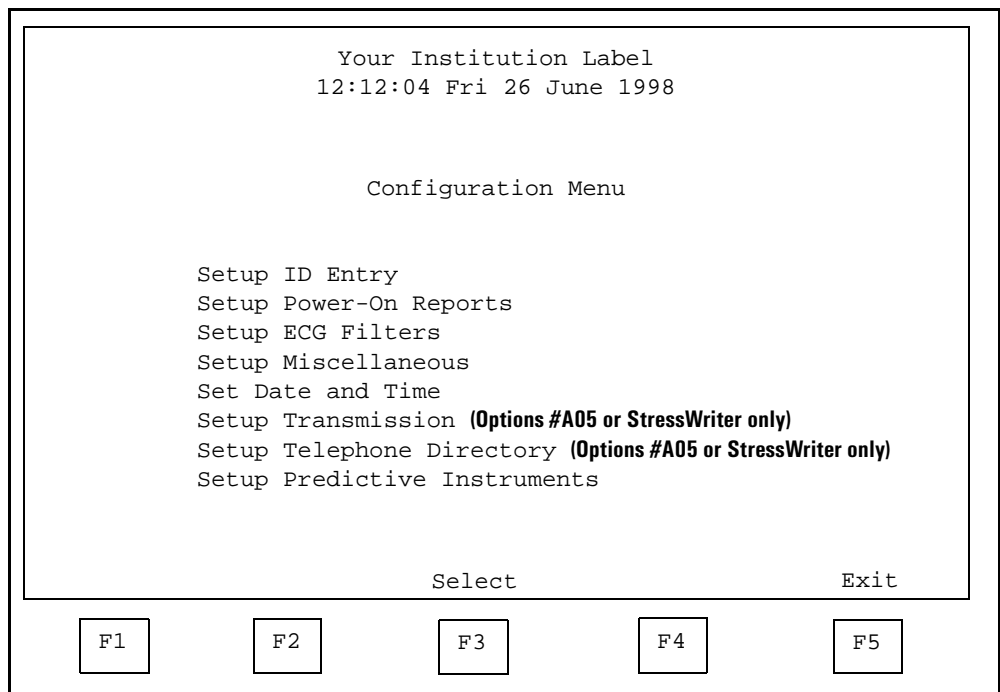

The following describes the basic functions for each entry in this menu.

### **Setup ID Entry**

This selection allows you to choose:

- the patient identification entries requested before recording an ECG
- the units used for patient Age, Height, and Weight
- the labels for the two Custom Fields.

### **Setup Power-On Report Formats**

Allows you to select default report formats to be used when the instrument is turned on.

### **Setup ECG Filters**

Allows you to set the filters to be used for the different operating modes.

### **Setup Miscellaneous**

Allows you to enter the name of your institution which is printed on the ECG reports. Allows you to set the keyboard mode to upper- or lower-case, and to control the type of initial and copy interpretation. For Options #A05 or StressWriter, this screen also allows you to enter the cardiograph location code and the cardiograph ID number.

### **Set Date and Time**

Allows you to set the cardiograph's date and time.

### **Setup Transmission (Options #A05 or StressWriter only)**

If your cardiograph is equipped with Options #A05 or StressWriter, this selection allows you to configure it to send and receive ECGs.

### **Setup Telephone Directory**

If your cardiograph is equipped with Options #A05 or StressWriter, this selection allows you to record the names, telephone numbers, and transmission types and speeds of four sites to which you send or receive ECGs.

### **Setup Predictive Instruments (PageWriter 300pi Model only)**

Your cardiograph is equipped with Predictive Instrument capability; you must indicate the configuration and select the clinical mode of operation.

### **Configuration Menu Softkeys**



















**Exit** Returns you to the main screen.

**Select** Displays the highlighted menu.

---

## Navigating the Configuration Menus

When you need to change the cardiograph configuration, use the following techniques:

1. To select from a menu, press  or  to move the cursor down, or press  or  to move the cursor up until the desired menu line is highlighted. Then press **Select** () or  to display the selected item.
2. To select a field on a data entry screen, press  or  to move the cursor down, or press  or  to move the cursor up until the desired entry line is highlighted. When you leave a line or press  or **Exit** (), the data is recorded.
3. To change a field, select  to step through the choices available. Depending on the entry line you selected,  will be labeled **Change**, **Change Value**, **Change Format**, **Change Speed**, or **Change Lead**.
4. To change or erase data on the Miscellaneous or Date/Time menus, press the  key to erase characters to the left or press **Erase** () and type the new data.
5. To exit the Configuration menu, press  or **Exit** () .



---

## Patient ID Entries

This menu allows you to choose the patient identification entries requested prior to recording an ECG. Table B-1 shows the patient identification entries available for configuration. You can use Custom Label Field 1 and 2 to record information useful to your department that is not included in the standard Patient ID fields. For example, you may want to record patient medications that affect cardiac function on the ECG report. You can change the field name “Custom label 1” to “Medications”. You will be prompted to enter the patient’s medications as you enter other patient ID information.

Use **Change** ( **F3** ) or **Space** bar to change a **Yes/No** field. Use **Erase** ( **F1** ) or **Back** to change Custom label entries.

### Disabling Patient ID

To configure your cardiograph to request no ID information:

1. From the configuration menu, select `Setup Patient ID Entry`.
2. Press **Select** ( **F3** ) or **←**. The Patient ID Entry menu appears.
3. Press **Change** ( **F3** ) to select `No` for each `Yes/No` field.
4. Press **Erase** ( **F1** ) to erase each `Custom label` entry.
5. Press **Exit** ( **F5** ) until you return to the Idle screen, or **Stop** once to save the configuration.

---

#### NOTE

The patient age, sex, height, and weight affect the interpretation of the ECG and are needed by the Predictive Instruments application of the PageWriter 300pi. For the most accurate interpretation, they should be included in the patient ID entry. At a minimum, age and sex should be entered.

---

**Table B-1: Configurable Patient ID Entry Fields**

Parameter	Choices <sup>a</sup>	Comments
Patient ID	<b>Yes</b> or <b>No</b>	
Name	<b>Yes</b> or <b>No</b>	
Age	<b>Yes - Years</b> Yes - Year of Birth Yes - Months Yes - Weeks Yes - Days Yes - Hours No	
Sex	<b>Yes</b> or <b>No</b>	
Chest/LA pain entry? <sup>b</sup>	Yes or <b>No</b>	
Acute Ischemic Sx time Entry? <sup>b</sup>	Yes or <b>No</b>	
History Diabetes Entry? <sup>b</sup>	Yes or <b>No</b>	
History Hypertension Entry? <sup>b</sup>	Yes or <b>No</b>	
Height	<b>Yes - cm</b> Yes - in No	
Weight	<b>Yes - kg</b> Yes - lb No	
Operator	<b>Yes</b> or <b>No</b>	
Department	<b>Yes</b> or <b>No</b>	

B



**Table B-1: Configurable Patient ID Entry Fields**

Parameter	Choices <sup>a</sup>	Comments
Room	<b>Yes</b> or No	
Blood Pressure	<b>Yes</b> or No	
Requested by	<b>Yes</b> or No	
Custom label 1	Example: Insurance Number	You can enter up to 16 characters, which will appear as a field label on the Patient ID Entry screen <sup>c</sup> .
Custom label 2	Example: Medications	You can enter up to 16 characters, which will appear as a field label on the Patient ID Entry screen <sup>c</sup> .
ECG Mgmt Priority Entry?	<b>Yes</b> or No	Setup ID entry for ECG management system priority to indicate a 'STAT' ECG. Only applies to cardiographs with storage and transmission.

- a. Default values are shown in boldface type.
- b. PageWriter 300pi only.
- c. Only the first eight characters of a custom labels are transmitted when sending the ECG to a TraceMaster ECG Management system.

## Power-On Report Fields

This menu allows you to choose the default report formats that will automatically be used when you power-on the cardiograph. Table B-2 shows the available report formats. Use **F3**, labeled **Change Format**, **Change Speed**, or **Change Lead** to change a field.

**Table B-2: Configurable Report Characteristics**

Parameter	Choices <sup>a</sup>	Comments
Lead System	<b>Standard</b> Cabrera	
Auto Format	3x4 <b>3x4, 1R</b> 3x4, 3R 6x2	Default for Cabrera leads
Manual Format	<b>3</b> 6 12	
Auto Report Speed	<b>25 mm/sec</b> 50 mm/sec	
Custom Rhythm Leads (Standard) for: 3x4, 1R  3x4, 3R, Manual 3  Manual 6	<b>I, II, III, aVR, aVL, aVF, V1, V2, V3, V4, V5, V6</b> <b>I, II, III, aVR, aVL, aVF, V1, V2, V3, V4, V5, V6</b> <b>I, II, III, aVR, aVF, aVL, V1, V2, V3, V4, V5, V6</b>	Select any lead  Select any three leads  Select any six leads

B

**Table B-2: Configurable Report Characteristics**

Parameter	Choices <sup>a</sup>	Comments
Custom Rhythm Leads (Cabrera) for: 3x4, 1R	<b>I, II, III</b> , -aVR, aVL, aVF, V1, V2, V3, V4, V5, V6	Select any lead
3x4, 3R, Manual 3	<b>I, II, III</b> , -aVR, aVL, <b>aVF</b> , V1, <b>V2</b> , V3, V4, V5, V6	Select any three leads
Manual 6	<b>I, II, III</b> , -aVR, <b>aVF</b> , aVL, <b>V1, V2</b> , V3, <b>V4</b> , V5, <b>V6</b>	Select any six leads

a. Default values are shown in boldface type.

## Filters

Your PageWriter 200/300pi cardiograph has been factory-configured with the filter settings which remove the most noise from the ECG. In addition to the default settings, your cardiograph offers a choice of several filter configurations. These filter settings are detailed below and in Table B-3.

- The 0.5 Hz Baseline Wander filter suppresses the greatest amount of baseline wander. However, in Manual mode, this filter may alter the ECG's ST segment.
- The 0.15 Hz Baseline Wander filter provides some baseline wander suppression without distorting the ECG's ST segment.
- The 0.05 Hz Baseline Wander filter delivers the highest fidelity signal, but provides the least baseline wander suppression.
- The 40 Hz Noise filter offers maximum noise suppression, but reduces the fidelity of the signal.
- The 100 Hz Noise filter provides some noise suppression while offering an accurate signal representation.
- The 150 Hz Noise filter delivers the highest fidelity signal, but provides the least high-frequency noise suppression.
- The Artifact filter may be enabled for Auto and Manual ECGs when the **Filter** key is pressed. It removes small-amplitude, high-frequency signals, characteristic of muscle tremor.

**NOTE**

When the **Filter** key is on, the user-configured combination of the Artifact, 0.5 Hz Wander, and 40 Hz Noise filters is enabled and the **Filter** status message appears in the upper-right corner of the display. Refer to Table B-3 for information on configuring the **Filter** key.

**NOTE**

If accurate ST segment contours are required for ECGs recorded in Manual mode, do not use the 0.5 Hz baseline wander filter. This filter suppresses baseline wander to the extent that it may alter the ST segment. Instead, configure your cardiograph to use the 0.15 Hz or 0.05 Hz baseline wander filter. Regardless of the filter used, the rhythm characteristics of the ECG are accurately recorded.

**Table B-3: Configurable Filters**

Parameter	Choices <sup>a</sup>	Comments
Auto Baseline Wander Filter	0.05 Hz <b>0.15 Hz</b> 0.5 Hz	Select one baseline wander filter for Auto ECGs.
Auto Noise Filter	<b>40 Hz</b> 100 Hz 150 Hz	Select one noise filter for Auto ECGs.
Manual Baseline Wander Filter	<b>0.05 Hz</b> 0.15 Hz 0.5 Hz	Select one baseline wander filter for Manual ECGs.
Manual Noise Filter	<b>40 Hz</b> 100 Hz 150 Hz	Select one noise filter for Manual ECGs.
<b>Filter</b> Artifact filter 0.5 Hz Baseline Wander filter 40 Hz Noise Filter	<b>Yes</b> or No <b>Yes</b> or No <b>Yes</b> or No	Select whether or not the artifact, baseline wander and noise filters are activated by the <b>Filter</b> key.

a. Default values are shown in boldface font.

---

## Miscellaneous Report Fields

### Institution Label

The Institution name is printed on all ECGs and is displayed at the top of the Configuration Menu. Press **Erase** ( **F1** ) to clear the field, then type a name.

### Set Keyboard

Keyboard mode determines whether characters will be printed and displayed in uppercase or lowercase. Press **Change** ( **F3** ) to change from lower[case] to UPPER[case] and vice versa.

### Initial and Copy Interpretation

Interpretation parameters determine which analysis information is included in an ECG report.

- **Initial Interpretation:**  
controls the information that is printed on the original ECG.
- **Copy Interpretation:**  
controls the information that is printed on ECG copies. If your cardiograph is equipped with Options #A05 or StressWriter, this is also the format that is stored, transmitted, or faxed.
- The settings are:

Reasons	Prints waveform and patient ID, basic measurements summary, and computer-generated ECG interpretation with reason statements.
None	Prints waveform and patient ID.
Measure	Prints waveform and patient ID, and basic measurements summary.
Interpret	PageWriter 300pi only. Prints waveform and patient ID, basic measurements summary, and computer-generated ECG interpretation.

- Press **Select** ( **F3** ) or **Space** bar to select the desired setting.

**Table B-4: Miscellaneous Report Fields**

Parameter	Choices <sup>a</sup>	Comments
Institution Name	Press <b>Erase</b> ( <b>F1</b> ) before typing the name to clear the field. Type the name of your institution.	40 character maximum
Set keyboard	<b>lower</b> UPPER	Lowercase letters Uppercase letters
Initial Interpretation	<b>Reasons</b> None Measure Interpret	PageWriter 300pi only.  PageWriter 300pi only.
Copy Interpretation	<b>Reasons</b> None Measure Interpret	PageWriter 300pi only.  PageWriter 300pi only.

a. Default values are shown in boldface font.

### **Cardiograph Location Code (Options #A05 or StressWriter only)**

The cardiograph location code identifies the cardiograph location to a TraceMaster ECG Management system. The number prints at the bottom of the report.

### **Cardiograph ID (Options #A05 or StressWriter only)**

The cardiograph ID code identifies the cardiograph to a TraceMaster ECG Management system. The number prints at the bottom of the report.

B

**Table B-5: Miscellaneous Report Fields (Options #A05 or StressWriter only)**

Parameter	Choices	Comments
Cardiograph Location Code	Any five digit numeric code	Options #A05 or StressWriter only. Must be set before transmitting to a TraceMaster ECG Management system.
Cardiograph ID	Any four digit numeric code	Options #A05 or StressWriter only. Must be set before transmitting to a TraceMaster ECG Management system.

---

## Setting Date and Time

You can select either a 12 hour clock or a 24 hour clock for the cardiograph. To change the clock type, move the cursor to the time format field. Press

**Change** (  ) to select AM/PM, or 24 hour.

To change the date and time, type over the existing data or press **Erase** (  ) and type in the new data.

Use the , , , and  keys to move to another field.

When the date and time have been set, press **Exit** (  ).

---

**NOTE**

The format of the date as it is entered may be different than that to which you are accustomed. The date is entered as Day first, Month second, and lastly, Year.

---

---

## Printing the Configuration

Print the configuration by selecting `Print the Configuration` from the Configuration Menu. Press `Select` (`F3`). The current configuration will print.

---

## Adjusting Display Screen Contrast

Press `Shift` with the `▲` or `▼` key to lighten or darken the contrast on the cardiograph display.

---

## Set-up Transmission (Options #A05 or Stress-Writer only)

If your cardiograph is equipped with Options #A05 or StressWriter, you can change the transmission configuration through the Set-up Transmission selection on the Configuration menu. There are four fields that must be configured before transmitting ECGs.

### Modem Initialization String

The modem initialization string is sent from the cardiograph to the cardiograph modem before dialing can begin. This string must be present before sending or receiving ECGs using the modem.

### Fax Initialization String

The fax initialization string is sent from the cardiograph to the cardiograph fax modem before dialing can begin. This string must be present before sending ECGs using the fax. The default fax initialization string normally does not need to be changed.



### Fax Grid

The fax grid controls the density of the ECG transmitted using the fax.

- **Full**: transmits both the five and one millimeter gridlines for the waveform portion of the ECG.
- **Partial**: transmits only the five millimeter gridlines for the waveform portion of the ECG.

### Connection Speed

The connection speed determines the rate at which information is received by the cardiograph when a remote device initiates transmission. This speed must be set to match the transmission speed of the remote device.

**Table B-6: Set-up Transmission Fields (Options #A05 or StressWriter only)**

Parameter	Choices <sup>a</sup>	Comments
Modem Initialization string	AT &F M0 E0 &C1 &D2 S0=0 &S0 &M0 &W AT	For the M1706B modem. Check your modem documentation for the correct initialization string if you are using a different modem. The modem initialization string may be up to 39 characters.
Fax Initialization string	AT &F M0 E0 &C1 &D2 &S0 +FCLASS=1	May be up to 39 characters.
Fax grid	<b>Full</b> Partial	

**Table B-6: Set-up Transmission Fields (Options #A05 or StressWriter only)**

Parameter	Choices <sup>a</sup>	Comments
Connection speed	300 1200 <b>2400</b> 4800 9600 14400 96200 28800 38400 57600 76800 115200	

a. Default values are shown in boldface font.

Set-up Transmission (Options #A05 or StressWriter only)

# C Specifications

---

## Basic Controls

### ECG Controls:

- On/Standby
- Auto
- Manual
- Copy
- Filter
- Page Advance (paper feed)
- ID
- Stop

### ECG Format Selections:

- Auto (3x4 with 0, 1, or 3 rhythm leads; or 6x2)
- Manual (with 3, 6, or 12 leads)

### Keyboard

Keyboard with full alphanumeric capability

### Storage (Options #A05 or StressWriter only):

30 ECGs stored, maximum capacity 64 Kb each



**Hardware Interface:**

- 9-pin Male subminiature D, EIA-232 port
- Connection Speed (DTE Speed) 300-115200 bps configurable
- Communications Protocols: DT, SCP

**Transmission (Options #A05 or StressWriter only)**

DT protocol is a data transmission standard used to transmit information between PageWriter cardiographs, and TraceMaster ECG Management Systems.

SCP protocol is a data transmission standard, as described in the European Committee for Standardization, Standard Communications Protocol - Computer-Assisted Electrocardiography, (CEN/TC 251), used to transmit information between the PageWriter cardiographs and supported SCP systems.

**Display:**

240 x 128 pixel STN (Super Twisted Nematic) high contrast liquid crystal display for ECG preview. The display operates at 16 lines by 40 columns for operator interaction.

**Required Modem Command Interfaces:**

- Data Modem Command Interface: Standard AT Command Set
- FAX Modem Command Interface: EIA/TIA-578 Service Class 1

**Recommended Modem Protocols:**

- Modulation Protocol: V.34
- Error Correction Protocol: V.42
- Compression Protocol: V.42 bis
- FAX Modulation Protocol: V.17

---

## Frequency and Impulse Response

Meets AAMI EC11-1991 standard for Diagnostic Electrocardiograph Devices. Meets frequency response standard by methods A, D, and E when configured with 0.15-150 Hz filters.

---

## Instrument Test

An extended self-test may be started by pressing and holding the **Auto** and **Manual** keys simultaneously, and then pressing the **On/Standby** key. The test results are displayed on the LCD display and on a printed report for use by service personnel. This self-test runs continuously until the cardiograph is turned to **Standby** (off).

---

## Patient Safety

### Patient Isolation:

- Less than 20  $\mu$ A leakage current with 120 VAC, at 60 Hz, with patient cable
- Less than 50  $\mu$ A leakage current with 240 VAC, at 50 Hz, with patient cable

### Protection from Electric Shock:

- Class I

### Defibrillation Protection:

- Protected against damage from 400 joule defibrillator discharges

---

## Power and Environment

### Line Power:

- 100 to 120 VAC, 50 to 60 Hz (at 115 VAC power-switch setting)
- 220 to 240 VAC, 50 to 60 Hz (at 230 VAC power-switch setting)
- 50 VA Maximum.

**Fuse:**

- T 400mA, 250 V for both the 115 and 230 Vac switch settings.

**Environmental Operating Conditions:**

- 10 to 40° C (50 to 104° F)
- 15 to 80% relative humidity, non-condensing
- up to 4,550 m (15,000 ft.) altitude

**Environmental Storage Conditions:**

- 0 to 50° C (32 to 122° F)
- 15 to 90% relative humidity, non-condensing
- up to 4,550 m (15,000 ft.) altitude

**Cardiograph Dimensions:**

- 44 by 39 by 11 cm (17.0 by 15.3 by 3.9 in.)

**Cardiograph Weight:**

- 8.5 kg (18.8 lbs.)

# Glossary

**AC filter:** A filter that screens out ECG artifact caused by power line interference. This filter is built into the cardiograph and cannot be disabled.

**AC line interference:** electrical signals originating from the alternating current carried by power cords or other electrical equipment. AC line interference may obscure important details of the ECG trace.

**adult criteria:** Interpretive rules used when analyzing ECGs of persons aged 16 years or older.

**AHA leads:** ECG lead names and identifying colors recommended by the American Heart Association. Limb leads are labelled RA, LA, LL, RL. Chest leads are labelled V1-V6. (See *IEC leads*)

**alphanumeric:** Composed of both letters and numbers. The PageWriter 300pi cardiographs have an alphanumeric keyboard.

**alternating current (AC):** Electrical current provided by wall outlets. AC may be either 60 or 50 Hz depending on country.

**analysis criteria:** Rules used to interpret ECGs.

**artifact:** ECG waveform distortion that may diminish ECG quality. ECG artifact (or noise) may be caused by electrical interference, poor electrode connections, or patient movement.

**artifact filter:** Term for filter which screens out noise on the ECG caused by muscle tremor.

**Auto ECG:** Twelve-lead ECG which shows 10 seconds of heart activity and is printed in a preselected format.

**baseline wander:** A slow upward or downward motion on the baseline of any ECG waveform.

**baseline wander filter:** Term for the configurable filter which reduces baseline wander.



---

**battery saver:** Term for the cardiograph turning itself to Standby (off) automatically after a preset time period to conserve power. The battery saver is factory set for 30 minutes of cardiograph inactivity.

**Cabrera:** an alternative limb lead order in which aVR is inverted and shown as -aVR. Lead order is aVL, I, -aVR, II, aVF, III, V1 through V6.

**calibration pulse:** A 200 ms, 1 mV square or stepped wave pulse which appears on the printed record. The calibration pulse shows the sensitivity at which the ECG was recorded.

**chest leads:** leads V1 through V6 (AHA), or C1 through C6 (IEC)

**configuration:** The manner in which the cardiograph is programmed to function.

**cycle power:** To press the **On/Standby** button to put the cardiograph in Standby mode (off), then press the **On/Standby** button again to turn the cardiograph back on.

**direct transmission:** moving data between a cardiograph and TraceMaster, or between two cardiographs using a data cable connected to both devices.

**directSCP:** direct transmission using the *Standard Communication Protocol*, as described in the European Committee for Standardization, Standard Communication Protocol - Computer Assisted Electrocardiography, (CEN/TC 251).

**DT:** the protocol used to transmit information between PageWriter cardiographs and TraceMaster ECG Management Systems.

**ECG analysis:** Computerized process for measuring and interpreting an Auto ECG.

**ECG report:** Paper copy produced by the cardiograph when the operator presses the **Auto** or **Manual** start key. This report includes a graphic representation of the heart's electrical activity (ECG waveforms) and identifying information. It may also include interpretive information produced by the analysis software in the PageWriter 300pi cardiograph. ECG reports must be overread by qualified physicians.

**extended measurements report:** this two page report summarizes the morphology and rhythm characteristics for the individual lead waveforms and rhythm groups in the ECG.

---

**front panel:** the area of the Cardiograph that includes the preview display and keyboard.

**Hertz (Hz):** A unit of frequency equal to one cycle per second.

**ID fields:** Term for the areas where patient information can be entered. Using the ID fields, you can enter information such as patient identification number, name, and age.

**IEC leads:** Lead names and identifying colors recommended by the International Electrotechnical Commission standard. IEC limb electrodes are labelled R, L, F, and N. Chest electrodes are labelled C1 through C6.

**leads off:** one or more lead names appearing in the upper-left corner of the screen and printer report indicates that those leads are not making a good connection with the patient. Leads off is also seen on the screen and the printed report as a dotted line trace.

**Manual ECG:** ECG report format which runs continuously until the operator stops the recording. The ECG may show three, six, or twelve lead waveforms. This format is also known as a rhythm strip.

**measurements:** The amplitudes, durations, areas, and intervals which characterize the ECG waveform.

 (Menu key): the cardiograph key that displays the configuration menu selections on the cardiograph's front panel display.

**modem:** a device that converts data from an electronic device into signals that can be carried by telephone line to another location where it is received by another modem and converted to data for use in another electronic device.

**modemSCP:** transmission by modem, using the Standard Communication Protocol, as described in the European Committee for Standardization, Standard Communication Protocol - Computer Assisted Electrocardiography, (CEN/TC 251).

**operator:** The person who records the ECG.

**overread:** To review an ECG report. This review must be completed by a qualified physician.

**patient cable:** the one-piece patient-lead set and instrument cable. The patient cable connects the cardiograph to the electrodes attached to the patient.

---

**pediatric criteria:** The interpretive rules used when analyzing ECGs of persons aged 15 years or younger.

**pre-acquisition:** Term for acquiring ten seconds of ECG before the operator presses the Auto key.

**preview screen:** the LCD display screen that shows the ECG traces as they will appear on the printed ECG report.

**rhythm strip:** the ten second recording of a particular lead that is printed at the bottom of an Auto ECG report. (See *Manual ECG* and *Auto ECG*)

**SCP:** Standard Communications Protocol, a data transmission standard, as described in the European Committee for Standardization, *Standard Communication Protocol - Computer Assisted Electrocardiography*, (CEN/TC 251).

**softkeys:** the labels or commands assigned to the function keys. The softkeys appear at the bottom of the front panel display, and are executed when the corresponding function key is pressed. These keys are noted in this manual as softkeys.

**standard leads:** the conventional twelve lead set order is I, II, III, aVR, aVL, aVF, and V1 through V6.

**Welsh cups:** reusable chest electrodes held in place by suction cups. Limb plate electrodes are used on the arms and legs when Welsh cups are used on the patient's chest.

**A**

AC  
fuse 7-8, 7-11  
Fuse holders 7-9  
fuse holders 1-3, 7-8  
operation 1-12  
power 1-13  
power light 1-5  
AC interference 6-2  
AC line interference  
Glossary-1  
AC operating frequency  
A-1  
AC voltage  
setting A-1  
accessories 1-8  
ACI-TIPI report  
T0 2-33  
adult criteria Glossary-1  
AHA leads Glossary-1  
AHA patient cable 7-10  
alphanumeric Glossary-1  
Alt 1-5  
Alt-char 1-5  
alternating current  
Glossary-1  
analysis criteria Glossary-1  
arrow keys 1-5

artifact Glossary-1  
artifact filter B-12,  
Glossary-1  
Auto baseline wander  
filter B-13  
Auto ECG Glossary-1  
and Copy key 2-14  
copying 2-14  
recording 2-12  
Auto key 2-13  
Auto report  
rhythm leads 2-16  
automatic shut-off 1-13

**B**

baseline wander  
Glossary-1  
baseline wander filter B-12,  
Glossary-1  
battery 7-7, 7-10  
capacity 1-13  
charging 1-13  
disposal A-5  
door 1-3  
installing A-3  
low 1-13  
operation 1-12  
removing A-4  
saving 1-13  
battery saver Glossary-2

**C**

Cabrera Glossary-2  
calibration pulse  
Glossary-2  
carrying case 7-10  
cart 7-11  
mounting point 1-3  
Change Format softkey  
B-7  
Change Lead softkey B-7  
Change softkey 2-7, B-7  
Change Speed softkey B-7  
changing  
a report format 2-16  
patient ID 2-8  
checking ECG technique  
6-1  
chest leads Glossary-2  
cleaners, approved 7-1  
cleaning 7-1  
electrodes 7-2  
paper sensor 7-4  
printhead 7-3

configuration B-1,  
Glossary-2  
and Change Format  
softkey B-7  
and Change Lead  
softkey B-7  
and Change softkey  
B-7  
and Change Speed  
softkey B-7  
and Change Value  
softkey B-7  
and Exit softkey B-7  
for transmission B-17  
modem setup B-17  
configuring the  
cardiograph A-1  
connecting the patient  
cable A-7  
connecting the power  
cord A-6  
Continue using Old ID?  
2-11, 2-13  
copy interpretation B-5  
Copy key 1-5, 2-14, 3-8  
copying Auto ECGs 2-14  
criteria  
adult Glossary-1  
analysis Glossary-1  
custom ID fields 2-10  
cycle power Glossary-2

## D

data transmission rate A-  
20, B-19  
date/time setting B-16  
deleting stored ECGs 4-6  
direct SCP A-16  
display  
adjusting contrast B-  
17  
display lead groups 2-5  
DT Glossary-2

## E

ECG  
checking quality 2-5  
improving quality 2-5  
Manual Glossary-3  
quality 2-2, 2-5  
recording 2-1  
sensitivity 2-11, 2-12  
ECG analysis Glossary-2  
ECG logs 4-9  
printing 4-8

ECG problems  
AC interference 6-2  
identifying 6-2  
intermittent waveform  
6-3  
jittery waveform 6-3  
muscle artifact 6-3  
paper 6-4  
print quality 6-3  
respiratory  
interference 6-3  
tremor 6-3  
ECG report Glossary-2  
ECG reports  
storing 7-6  
ECGs  
deleting stored 4-6  
receiving 5-8  
storage 4-1  
electrodes 7-11  
Welsh cups Glossary-  
4  
entering patient ID 2-6  
error messages 6-5  
Exit softkey 2-7, B-6, B-7  
extended measurements  
report Glossary-2

## F

fax problems 6-8  
faxing ECGs 5-1, 5-7, A-  
15

- 
- Filter key 1-5, 2-11  
    and Manual ECGs 2-11  
    sequence 2-12, 2-13
- filters  
    artifact B-13  
    Auto ECG B-13  
    baseline wander B-12  
    Manual ECG B-13  
    noise  
        Auto B-13  
        Manual B-13
- Format softkey 2-11, 2-12, 2-16  
    sequence 2-11, 2-12
- formats  
    Auto ECG report B-11
- front panel 1-4, Glossary-3
- fuse 7-9, 7-11  
    AC 7-11  
    battery 7-10  
    replacing 7-8
- fuse holders  
    AC 1-3
- H**
- Hertz (Hz) Glossary-3
- I**
- ID  
    patient B-5  
    ID fields Glossary-3
- ID key 1-5
- ID, patient 2-6  
    changing 2-8  
    custom fields 2-8  
    entering 2-6  
    reviewing 2-8
- IEC leads Glossary-3
- IEC patient cable 7-10
- initial interpretation B-14
- installing the battery A-3
- interference  
    AC line Glossary-1
- L**
- lead groups 2-5  
    Manual 2-16
- leads  
    AHA Glossary-1  
    chest Glossary-2  
    IEC Glossary-3  
    standard Glossary-4
- leads off Glossary-3
- leads off indication 2-2
- Leads Softkey 2-12
- Leads softkey 2-11, 2-16  
    sequence 2-12, 2-13
- loading paper 7-5, A-9
- log of ECGs stored 4-9
- log of ECGs taken 4-9  
    printing 4-8
- M**
- maintenance 7-1
- Manual ECG 2-10, Glossary-3  
    baseline wander filter B-13  
    rhythm leads B-11
- Manual key 1-5, 2-10, 2-16
- Manual lead groups 2-16
- Manual report  
    and Filter key B-13  
    and Stop key 2-16  
    formats 2-16
- measurements Glossary-3
- memory  
    non-volatile B-1
- menu  
    configuration B-2
- Menu key 1-5, Glossary-3
- modem 5-7, A-14, A-16, Glossary-3  
    SCP A-17
- modem problems 6-8
- ModemSCP 5-8
- modemSCP Glossary-3
- N**
- New patient? 2-6
- No ID, Continue? 2-10, 2-13
-

---

## Index

noise filters B-12  
    Auto ECG B-13  
    Manual ECG B-13

## O

On/Standby key 1-5  
operator Glossary-3  
overread Glossary-3

## P

Page key 1-5, A-9  
paper 7-10  
    anti-fade 7-10  
    loading 7-5, A-9  
    storing 7-6  
paper problems 6-4  
paper sensor  
    cleaning 7-4  
parameters, configuration  
    B-5

patient cable 1-2,  
    Glossary-3  
    AHA 7-10  
    and abrasives 7-2  
    and AC interference 1-  
        10  
    and autoclaving 7-2  
    and isopropyl alcohol  
        7-2  
    and ultrasonic  
        cleaners 7-2  
    connecting A-7  
    IEC 7-10  
    immersing 7-2  
    routing 1-10  
patient ID 2-6  
    editing 4-7  
    entering 2-6  
patient ID fields 2-8  
patient preparation 2-2  
pediatric criteria  
    Glossary-4  
power cord 1-10, A-6  
power light 1-5, 6-4  
pre-acquisition Glossary-  
    4  
preparing the patient 2-2  
preview screen Glossary-  
    4  
print problems 6-3

printed report  
    understanding 2-15  
printhead  
    cleaning 7-3  
printing  
    ECG logs 4-8  
    stored ECGs 4-8  
printing Extended  
    Measurements Report  
    2-14, 3-8

## R

Receiving ECGs 5-8  
receiving ECGs 5-1  
recording  
    Auto ECG 2-12  
    ECG 2-1  
    Manual ECG 2-10  
removing the battery A-4  
replacing fuses 7-8  
report  
    ECG Glossary-2  
report fields 2-17  
report format  
    changing 2-16  
report formats B-11  
    Auto ECG 2-16  
    Manual 2-16  
Report softkey 2-16  
requesting an ECG 5-9  
reviewing ID 2-8

rhythm leads  
    Auto ECG B-11  
rhythm strip Glossary-4

**S**

safety 1-10  
SCP A-16  
Select softkey 4-5, 4-6, 5-3, 5-10, 5-16, B-6, B-7  
sending ECGs 5-1  
    direct 5-7, A-17  
    fax 5-7, A-17  
    modem 5-7  
setting the date/time B-16  
setting up the cardiograph A-1  
shock hazard 1-10  
shut-off, automatic 1-13  
Size softkey 2-11, 2-13  
    sequence 2-12, 2-13  
softkeys 1-5, Glossary-4  
speed 2-11, 2-12  
    Auto report B-11  
Speed softkey 2-11, 2-13  
    sequence 2-13  
standard communications protocol A-17  
standard leads Glossary-4  
Stop key 1-5  
    Manual ECGs 2-11, 2-16

storing  
    ECG reports 7-6  
    ECGs 4-2  
    paper 7-6  
    the battery 7-8

**T**

telephone directory  
    editing 5-6  
    setting up A-15  
TPI report  
    H0 2-31  
transmission  
    configuration B-17  
transmission problems 6-7  
transmitting ECGs 5-1  
    direct 5-7, A-16  
    fax 5-7, A-17  
    modem 5-7, A-17  
troubleshooting 6-1

**U**  
understanding reports 2-15

**V**  
voltage select switch A-1, A-6

**W**  
Welsh cups Glossary-4









M1770-91930  
Edition 2

Copyright © 1999  
Agilent Technologies Incorporated  
Printed in USA November 1999