



Your Solutions Partner

OWNER'S MANUAL

FLEXTECH™ HUMIDIFIED HOLDING CABINET STACKED CONFIGURATION

Model:
FTU-5

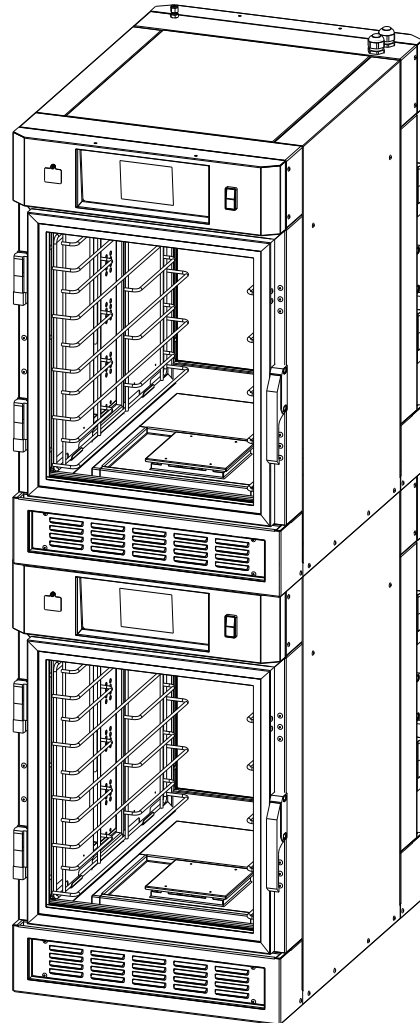

**IMPORTANT INFORMATION, READ BEFORE USE.
PLEASE SAVE THESE INSTRUCTIONS.**

*This manual is Copyright © 2013 Duke Manufacturing Company. All rights reserved.
Reproduction without written permission is prohibited. Duke is a registered
trademark of the Duke Manufacturing Company.*

Duke Manufacturing Company

2305 N. Broadway
St. Louis, MO 63102
Phone: 314-231-1130
Toll Free: 1-800-735-3853
Fax: 314-231-5074
www.dukemfg.com

P/N 169696A



TABLE OF CONTENTS

INTRODUCTION.....	3
IMPORTANT SAFETY INSTRUCTIONS	4
SPECIFICATIONS.....	7
MAIN FEATURES.....	9
INSTALLATION	10
OPERATING INSTRUCTIONS.....	18
CARE AND CLEANING.....	21
DOOR ADJUSTMENTS AND GASKET MAINTENANCE	24
PROGRAMMING CONTROLS.....	26
TROUBLESHOOTING	29
WIRING DIAGRAM	31

INTRODUCTION

IMPORTANT SAFETY INSTRUCTIONS

Throughout this manual, you will find the following safety words and symbols that signify important safety issues with regards to operating or maintaining the equipment.



Indicates a hazardous situation which, if not avoided, could result in death or serious injury.



Indicates a hazardous situation which, if not avoided, could result in minor or moderate injury.



Indicates Important Information



Indicates electrical shock hazard which, if not avoided, could result in death or serious injury and/or equipment damage.



Indicates hot surface which, if not avoided, could result in minor or moderate injury. Specifically, risk of burn from heating elements.



Indicates rotating fan blade hazard which, if not avoided, could result in minor or moderate injury.



Indicates hot surface which, if not avoided, could result in minor or moderate injury.

ELECTRICAL WARNINGS

THIS MANUAL HAS BEEN PREPARED FOR PERSONNEL QUALIFIED TO INSTALL ELECTRICAL EQUIPMENT, WHO SHOULD PERFORM THE INITIAL FIELD STARTUP AND ADJUSTMENTS OF THE EQUIPMENT COVERED BY THIS MANUAL.

READ THIS MANUAL THOROUGHLY BEFORE OPERATING, INSTALLING OR PERFORMING MAINTENANCE ON THE EQUIPMENT.

WARNING Failure to follow all the instructions in this manual can cause property damage, injury or death.

WARNING Improper installation, adjustment, alteration, service or maintenance can cause property damage, injury or death.

WARNING (US/CAN ONLY) Electrical connections should be performed only by a certified professional.

WARNING Electrical and grounding connections must comply with the applicable portions of the National Electric Code and/or all local electric codes. Failure to comply with this procedure can cause property damage, injury or death.

⚠ WARNING Before connecting the unit to the electrical supply, verify that the electrical and grounding connections comply with the applicable portions of the National Electric Code and/or other local electrical codes. Failure to comply with this procedure can cause property damage, injury or death.

⚠ WARNING Before connecting the unit to the electrical supply, verify that the electrical connection agrees with the specifications on the data plate. Failure to comply with this procedure can cause property damage, injury or death.

⚠ WARNING UL73 grounding instructions: This appliance must be connected to a grounded, metal, permanent wiring system. Or an equipment-grounding conductor must be run with the circuit conductors and connected to the equipment-grounding terminal or lead on the appliance. Failure to comply with this procedure can cause property damage, injury or death.

⚠ WARNING Appliances equipped with a flexible electric supply cord, are provided with a three-prong grounding plug (or a CEE7 Plug for International CE Units). It is imperative that this plug be connected into a properly grounded receptacle. Failure to comply with this procedure can cause property damage, injury or death.

⚠ WARNING If the receptacle is not the proper grounding type, contact an electrician. Do not remove the grounding prong from the plug. Failure to comply with this procedure can cause property damage, injury or death.

⚠ WARNING Before performing any service that involves electrical connection or disconnection and/or exposure to electrical components, always perform the Electrical LOCKOUT/TAGOUT Procedure. Disconnect all circuits. Failure to comply with this procedure can cause property damage, injury or death.

⚠ WARNING Before removing any access panels or servicing this equipment, always perform the Electrical LOCKOUT/TAGOUT Procedure. Be sure all circuits are disconnected. Failure to comply with this procedure can cause property damage, injury or death.

⚠ WARNING Do not operate this equipment without properly placing and securing all covers and access panels. Failure to comply with this procedure can cause property damage, injury or death.

⚠ WARNING For your safety, do not use or store gasoline or other flammable vapors or liquids in the vicinity of this or any other appliance. Failure to comply can cause property damage, injury or death.

⚠ WARNING In the event of a power failure, do not attempt to operate this appliance. Failure to comply can cause property damage, injury or death.

⚠ WARNING The main switch on the appliance is for standby power only. For all-pole disconnect remove plug from wall outlet.

In addition to the warnings and cautions in this manual, use the following guidelines for safe operation of the unit.





- Read all instructions before using equipment.
- Do not attempt to defeat the grounded connector.
- Install or locate the equipment only for its intended use as described in this manual.
- Do not use corrosive chemicals, water jet equipment, or other pressurized liquid spraying equipment to clean this unit.
- This equipment should be serviced by qualified personnel only. Contact the nearest Duke authorized service facility for adjustment or repair.
- Do not block any openings on the unit.
- A minimum clearance of 2" (50.8mm) from the top of the unit to the ceiling must be provided.
- Secure unit to a wall with brackets provided to prevent tipping.
- Unit may start operation with inadvertent contact with touch screen display or from other extraneous sources. Turn off all poles mains disconnects should abnormal or unwanted operation occur.
- This appliance can be used by children aged from 8 years and above and persons with reduced physical, sensory or mental capabilities or lack of experience and knowledge if they have been given supervision or instruction concerning use of the appliance in a safe way and understand the hazards involved. Children shall not play with the appliance. Cleaning and user maintenance shall not be made by children without supervision.
- Turn off external mains supply disconnect and allow unit to cool down before servicing or performing maintenance.
- The procedures in this manual may include the use of chemical products. You must read the Material Safety Data Sheets before using any of these products.
- Properly rated all poles mains protection and earthing compliance with local electric codes are required for safe operation of this unit.
- Water supply connections to the unit must comply with local plumbing code and/or standards.
- Disposal of the unit must be in accordance with local environmental codes and/or any other applicable codes.
- **SAVE THESE INSTRUCTIONS**

SPECIFICATIONS

Patent Pending
Model FTU-5

Unit Weight:	285 lbs / 129 kg
Maximum Unit Weight With Food	335 lbs / 152 kg

Line Ratings - FTU with Touch Screen Control				
Line Supply Voltage (V)	Line Supply Frequency (Hz)	Line Phase Configuration	Total Maximum Line Power Watts (W)	Total Maximum Line Current Amps (A)
208	60	Single Phase	4 450	23
230	50	Single Phase	4 450	17
240	60	Single Phase	4 450	20

Compliance Declaration - FTU with Touch Screen Control		
	Standard: UL197	File: KNGT.E17421
	Standard: CSA-C22.2 No. 109	File: KNGT7.E17421
	Standard: ANSI / NSF 4	File: TSQT.E157479
	Directive 2006/95/EC: EN60335 -1:2010 EN 60335-2-49:2008	Directive 89/336/EEC: EN62233:2008 EN61000-6-3:2010 EN55014-2:20081
	WEEE Directive 2002/96/EC RoHS 2011/65/EU	
Rated IPX4 for Stacked Configuration		



STACKED CONFIGURATION

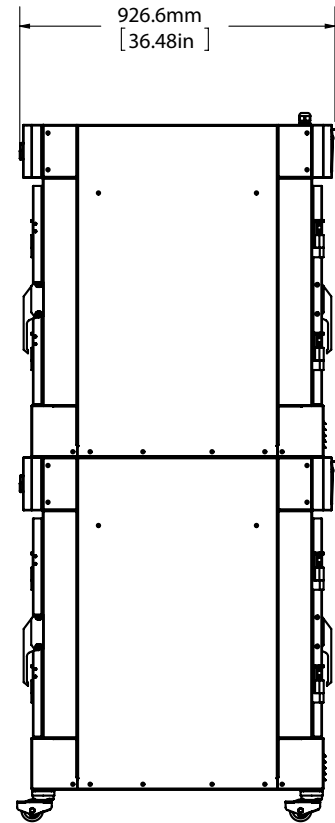
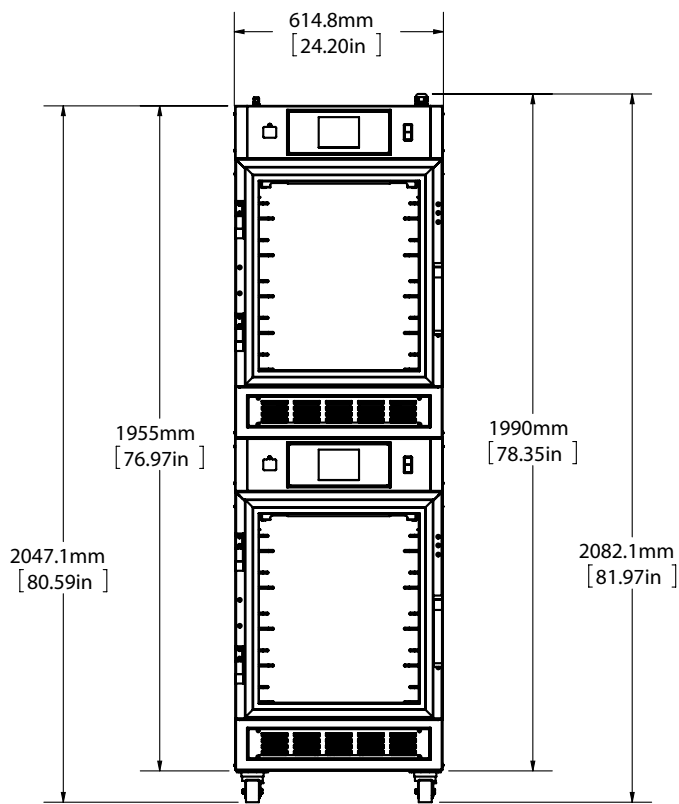
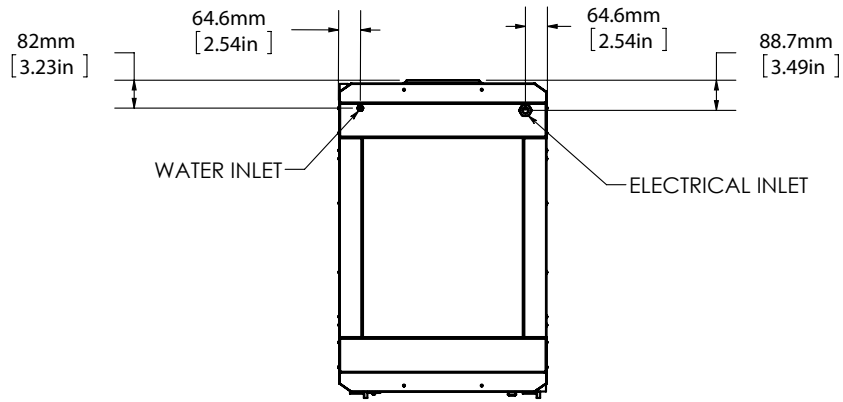

MAIN FEATURES

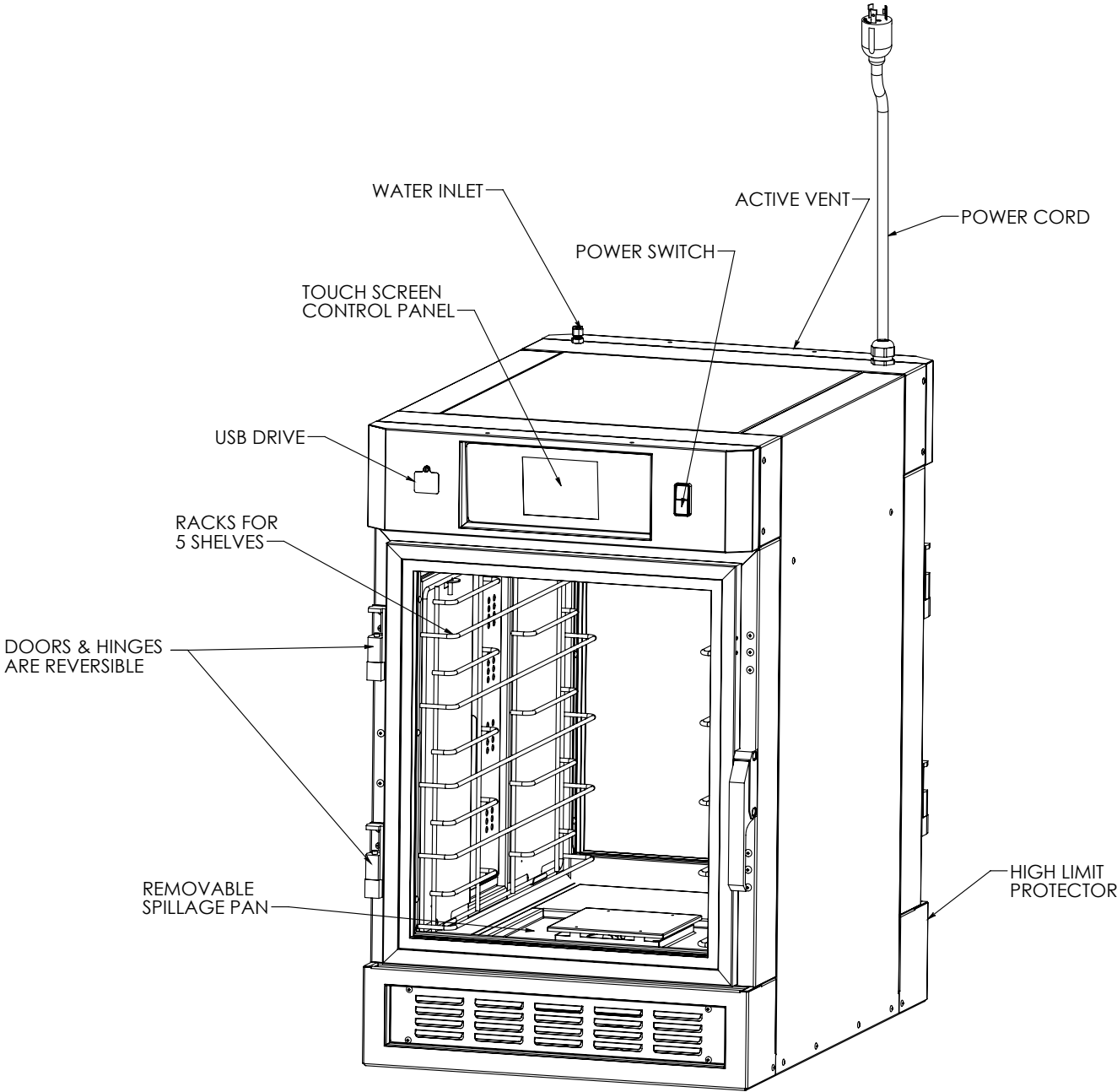

INSTALLATION

UNPACKING UNIT

Inspect the shipping carton and/or container, carefully noting any exterior damage on the delivery receipt; also note any damage not evident on the outside of the shipping container (concealed damage). Contact the carrier immediately and file a damage claim with them. Save all packing materials when filing a claim. Freight damage claims are the responsibility of the purchaser and are not covered by the warranty.

- Follow the instructions on the Carton Box for unpacking the unit.
- Inspect unit for damage such as, broken glass, etc.
- Report any dents or breakage to source of purchase immediately.
- **Do not attempt to use unit if damaged.**
- Remove all materials from unit interior.
- If unit has been stored in extremely cold area, wait a few hours before connecting power.

INSTALLATION CODES AND STANDARDS

In the United States, the FTU must be installed in accordance with the following:

1. State and local codes.
2. National Electrical Code (ANSI/NFPA No. 70, latest edition) available from the National Fire Protection Association, Batterymarch Park, Quincy, MA 02269.
3. Vapor Removal from Cooking Equipment, (NFPA-96, latest edition) available from NFPA.

In Canada, the FTU must be installed in accordance with the following:

1. Local codes.

2. Canadian Electrical Code (CSA C22.2 No. 3, latest edition) available from the Canadian Standards Association, 5060 Spectrum Way, Mississauga, Ontario, Canada L4W 5N6.

UNIT PLACEMENT

- Do not install unit next to source of heat, such as deep fryer, etc.
- Install unit on level surface floor.
- Minimum Clearance of 6" (152mm) must be maintained between the unit and any combustible substance.
- Front and back of the unit must remain open for proper airflow for electrical component cooling. Maintain a minimum clearance of 2" (51mm).

UNIT STACKING INSTRUCTIONS



ELECTRICAL SHOCK HAZARD.

TASKS MUST BE PERFORMED BY A QUALIFIED SERVICE TECHNICIAN OR ELECTRICIAN.



THE MAIN SWITCH ON THE APPLIANCE IS FOR STANDBY POWER ONLY.

FOR ALL-POLE DISCONNECT REMOVE PLUG FROM WALL OUTLET.

1. Disconnect power by removing plug from wall outlet.
2. Remove the black side panels from both the UPPER unit (with 2 power cords) and the LOWER unit (with casters) by removing the 6 screws per side. (Save the panels and screws to be reinstalled.)

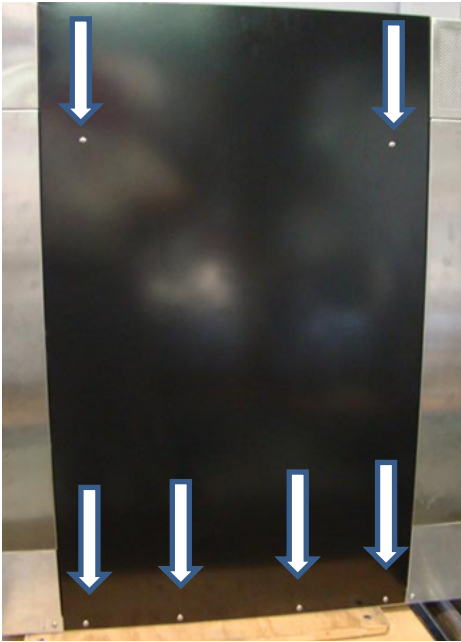

3. Remove the louvered covers from the UPPER unit by removing the screws (as shown typical).

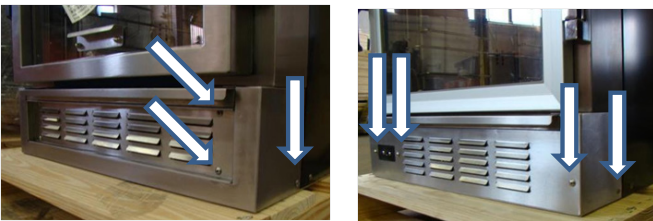

4. Remove the cover plates (4 places) from the base of the UPPER unit. This will give access to the holes used to bolt the UPPER unit to the LOWER unit.

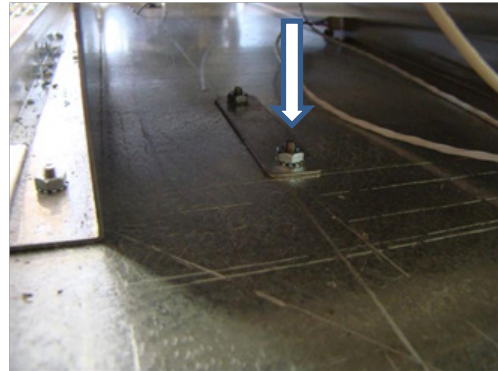

5. Carefully lift and place the UPPER unit on the LOWER unit. Align the holes in the base of the UPPER unit with the holes in the top black cover panel of the LOWER unit.
6. Bolt the units together using the hardware supplied (in the bag assembly). Insert a bolt downward through the aligned hole in UPPER unit base and the top of the LOWER unit (per the above) and affix the nut. Repeat 4 places.

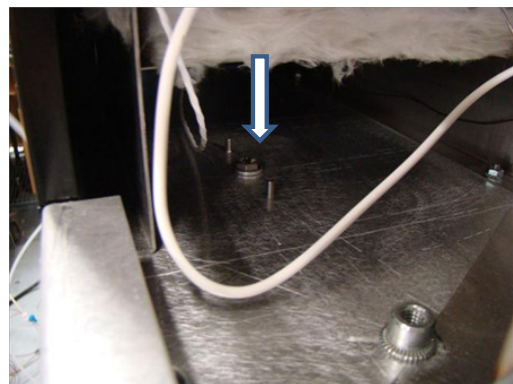

7. Locate the water line in the LOWER unit. Route the upper free end through the Heyco bushing into the bottom of the UPPER unit. Insert the tubing into the 'T' compression fitting and tighten. Route and straighten the tubing in the LOWER unit as shown.

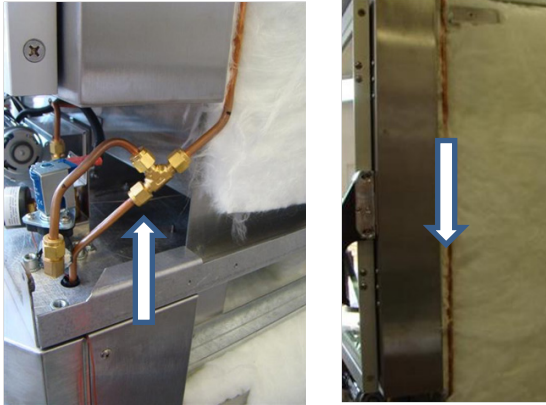

8. The LOWER unit power jumper harness is attached and enclosed in the UPPER unit. Route the jumper harness downward through the hole aligned in the UPPER unit base as shown.

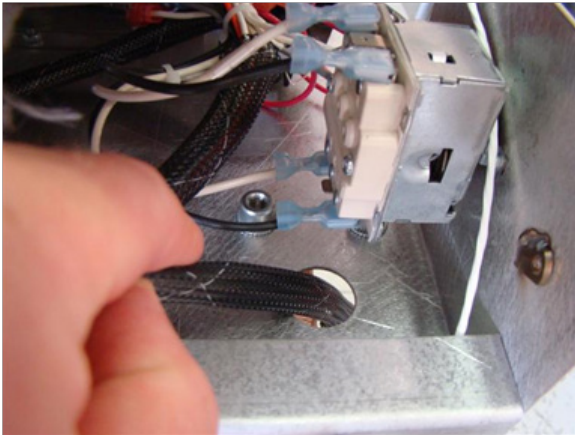

9. Attach the ground wire eyelet to the grounding screw and nut attached to the top of the LOWER unit. Connect the power lead wires.

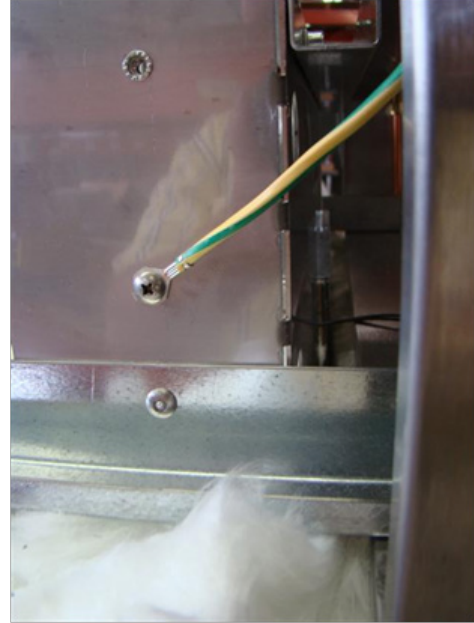

10. Reinstall all panels.



**ELECTRICAL SHOCK HAZARD UNIT
MUST BE SAFETY GROUNDED,
EARTHED.**

**DO NOT MODIFY, DEFEAT
ELECTRICAL CONNECTIONS OR
ALTER PLUG.**

ELECTRICAL CONNECTIONS

The US FTU models are factory wired for 208 Volts AC, single phase, 60 Hz.

⚠ WARNING BEFORE CONNECTING THE UNIT TO THE POWER SOURCE, VERIFY THAT THE VOLTAGE AND PHASE OF THE POWER SOURCE ARE IDENTICAL TO THE VOLTAGE AND PHASE INFORMATION ON THE DATA LABEL.

⚠ WARNING ELECTRICAL AND GROUNDING CONNECTIONS MUST COMPLY WITH THE APPLICABLE PORTIONS OF THE NATIONAL ELECTRICAL CODE AND/OR OTHER LOCAL ELECTRICAL CODES.

⚠ WARNING DO NOT STORE OR USE GASOLINE OR OTHER FLAMMABLE VAPORS OR LIQUIDS IN THE VICINITY OF THIS OR ANY OTHER APPLIANCE.

⚠ WARNING THE MAIN SWITCH ON THE APPLIANCE IS FOR STANDBY POWER ONLY. FOR ALL-POLE DISCONNECT REMOVE PLUG FROM WALL OUTLET.

Refer to wiring diagram in this manual for proper connection. Do not store flammables near unit.

1. At the circuit breaker, turn off power to the circuit to which the unit is to be connected.
2. Check that the unit Main Switch is in the STANDBY position.

3. Connect the power cord on the top of the unit to the electrical power source.
4. At the circuit breaker, turn on power to the circuit.

NOTICE If the supply cord is damaged, it must be replaced by a special cord or a special cord assembly available from Duke Manufacturing Co. or its service agent.

CAUTION In order to avoid a hazard due to inadvertent resetting of the thermal cut-out, this appliance must not be supplied through an external switching device, such as a timer, or connected to a circuit that is regularly switched on and off by the utility.

EARTHING INSTRUCTIONS

THE UNIT MUST BE GROUNDED. Grounding reduces risk of electric shock by providing an escape wire for the electric current if an electrical short occurs. This unit is equipped with a cord having a grounding wire with a grounding plug. The plug must be plugged into a receptacle that is properly installed and grounded.

Consult a qualified electrician or service agent if grounding instructions are not completely understood, or if doubt exists as to whether the oven is properly grounded.

DO NOT USE AN EXTENSION CORD. If the product power cord is too short, have a qualified electrician install a three-slot receptacle (or the country specific receptacle for International Units). This unit should be plugged into a separate circuit with the electrical rating as provided on the product data plate.

EXTERNAL EQUIPOTENTIAL BONDING TERMINAL (EXPORT ONLY)

This equipment has supplemental bonding terminal. The terminal provides an external bonding connection used in addition to the earthing prong on the plug. The terminal provides a connection for bonding to the equipment enclosure. The external equipotential bonding terminal is located on the rear outside surface of the oven, the terminal is marked with this symbol.



WATER SUPPLY CONNECTION

This equipment must be installed in accordance with all applicable federal, state, and/or local plumbing codes having jurisdiction.

NOTE: The Duke Flex Tech Humidified Holding Cabinet must be supplied with water from a Reverse Osmosis (RO) System.

See **INSTALLATION OF REVERSE OSMOSIS (RO) SYSTEM** section prior to water supply interconnect.

The water inlet utilizes 1/4" (6.35mm), OD plastic or copper tubing. Install the tubing in a manner to ensure there are no kinks, strains, or tight bends. Leave sufficient length to allow unit movement for service and cleaning.

The tubing should be cut square and be free of any deformations at the connection points. All burrs and sharp edges should be removed for proper connection.

Insert the tubing through the compression fitting with the threads pointing towards the end of the tubing.

Push the tubing into the fitting as far as it will go and tighten the nut with a 9/16" (14.3mm), wrench. Do not over-tighten the nut. If leaks occur, further tighten the fitting until the leakage stops.

INSTALLATION

1. This unit is supplied with the national and international specified water supply interconnection. Local regulation variances or additional requirements must be evaluated prior to installation. New water supply line interconnection must be used when installing this unit. Maximum / minimum supply pressure specification is 65PSI (450KPa) / 40PSI (275KPa) for all system plumbing components. See **INSTALLATION OF REVERSE OSMOSIS (RO) SYSTEM** section prior to water supply interconnect.
2. **IMPORTANT:** A minimum clearance of 2" (50.8mm) from the top of unit to the ceiling must be provided. Unit may be installed with minimal clearance on both sides of the cabinet. A minimum clearance of 2" from the front and back of the unit must be provided.
3. Check the door seal and make sure both doors close completely. If they do not close and seal properly, refer to the **DOOR GASKET ADJUSTMENT** section of this manual.
4. The stacked unit must be mechanically attached to wall using supplied wall-mounting brackets. Wall-mounting brackets are required for safe operation of the unit. Refer to **INSTALLATION OF WALL BRACKETS** section of this manual for the instructions.

TECHNICAL DESCRIPTION AND APPLICATION NOTES FOR FTU BACKFLOW PREVENTER SYSTEM

Check with your local authority having jurisdiction regarding approvals for connecting the Duke Flex Tech Humidified Holding Cabinet to a potable water supply before making any plumbing connections. Plumbing code requirements vary, but European Union (CE) and other jurisdictions require a backflow prevention device that is factory-installed or supplied. The backflow prevention device used on Duke FTU protects water supply systems by preventing the reverse flow of non-potable water into the potable domestic water system.

INSTALLATION OF REVERSE OSMOSIS (RO) SYSTEM

1. The Duke Flex Tech Humidified Holding Cabinet must be supplied with water from a Duke Reverse Osmosis (RO) System Model RO.
2. A single Duke RO System is able to support up to five Duke Flex Tech Humidified Holding Cabinets.
3. For detailed installation instructions of the RO system, see the instructions provided with the Duke Reverse Osmosis System.

INSTALLATION OF WALL-BRACKETS

NOTICE Wall brackets are required for stacked units.

NOTE: Verify interconnections and function prior to installing required wall brackets.

NOTE: Wall mounting bracket kit is universal and may be fastened to left hand or right hand side of unit.

NOTE: All steps apply to primary and or secondary mounting locations.

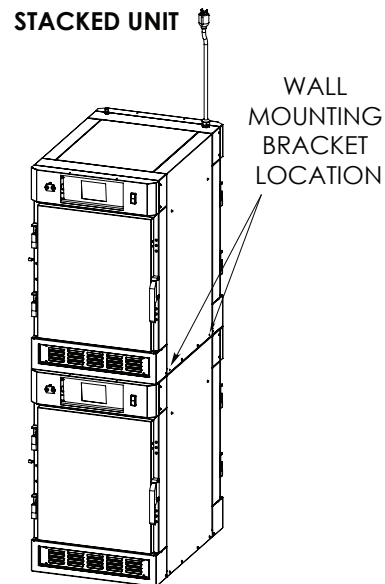

1. Attach Wall Mount Bracket to FTU with screws provided.

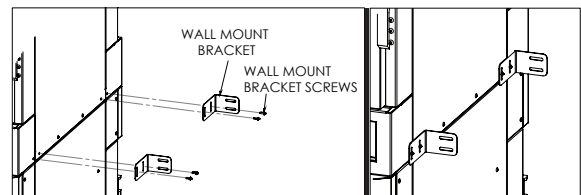

2. Mount Threaded Bracket to Wall Mount bracket, and tighten with screws provided.

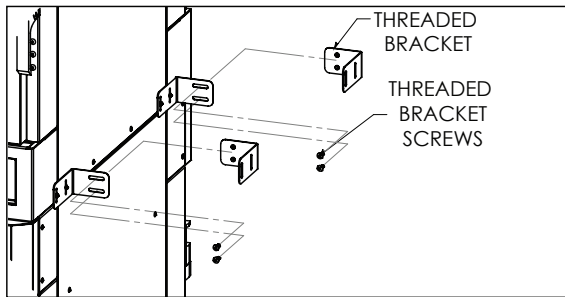

3. Move FTU to Operating Position, be sure the Threaded bracket can slide flush to wall.
4. Mark wall at each anchor mounting location.

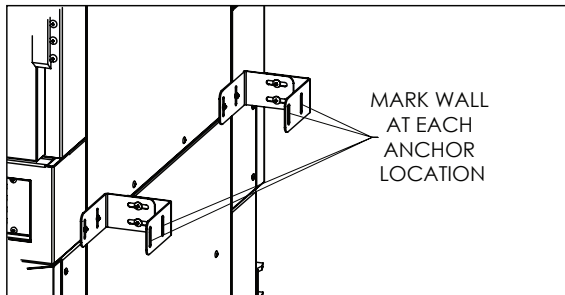

5. Drill anchor Holes at each marked wall anchor mounting location.

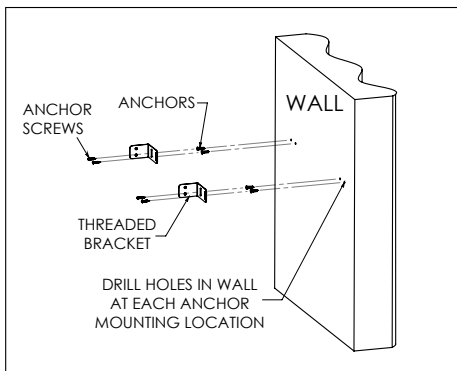

6. Insert wall anchors into drilled holes press flush to wall.

7. Remove screws from step 2 and mount Threaded Bracket to wall with anchor screws provided.

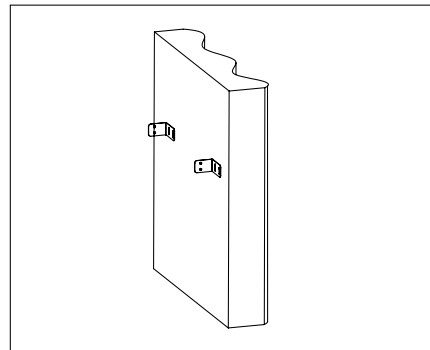

8. Move FTU to Operating Position.
9. Re-attach screws from step 7 and tighten and fasten brackets together.

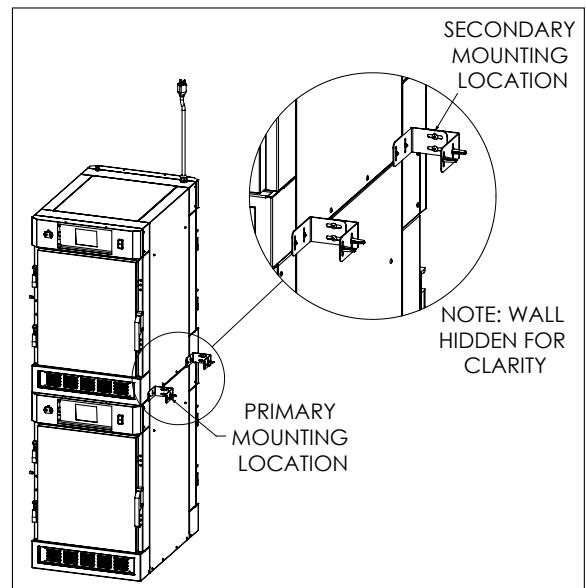
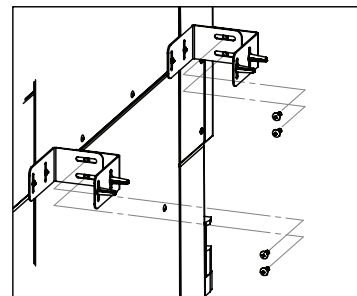

START-UP



ELECTRICAL SHOCK HAZARD.

TASKS MUST BE PERFORMED BY A QUALIFIED SERVICE TECHNICIAN OR ELECTRICIAN.



THE MAIN SWITCH ON THE APPLIANCE IS FOR STANDBY POWER ONLY.

FOR ALL-POLE DISCONNECT REMOVE PLUG FROM WALL OUTLET.

1. Connect the FTU to the power supply.
2. Turn power on to the unit with the main switch on the upper right side of the unit. Boot Screen is displayed and automatically transitions to the Main Screen.
3. The Recipe 1 button will turn to a BLUE background (the remaining Recipe buttons will be GRAY). The unit will start preheating. You may select an alternate Recipe at any time.

NOTE: The unit will not attempt to humidify the cabinet until it is 27°F (15°C) below set point. Additionally, at the same time, a 10 min. (or until the set point is reached) **SOAK CYCLE** is initiated to equalize the cabinet and to control the temperature overshoot from the residual heat of the main elements.

4. Verify humidification of the cabinet. Humidification will begin automatically. Humidity level will be controlled according to user-selected %RH set point.
5. Check the door seals and make sure both doors close completely.
6. If the unit does not power up correctly or if the doors do not close and seal properly, call Duke for assistance.

OPERATING INSTRUCTIONS

TOUCH SCREEN DEFINITIONS

Preheat Screen

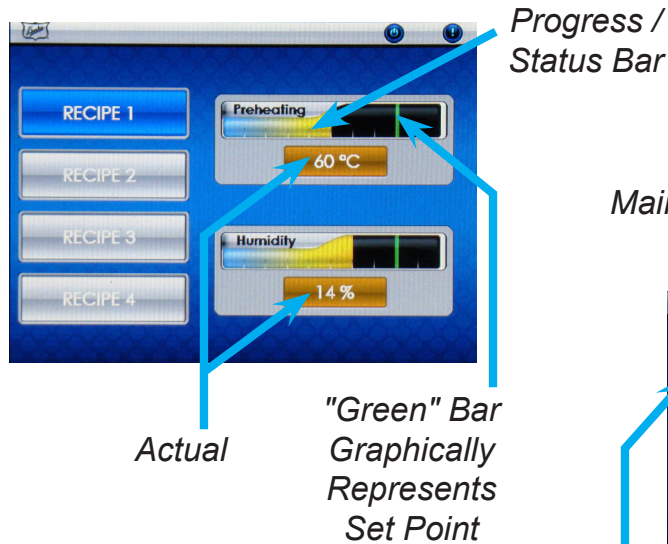

Run Screen

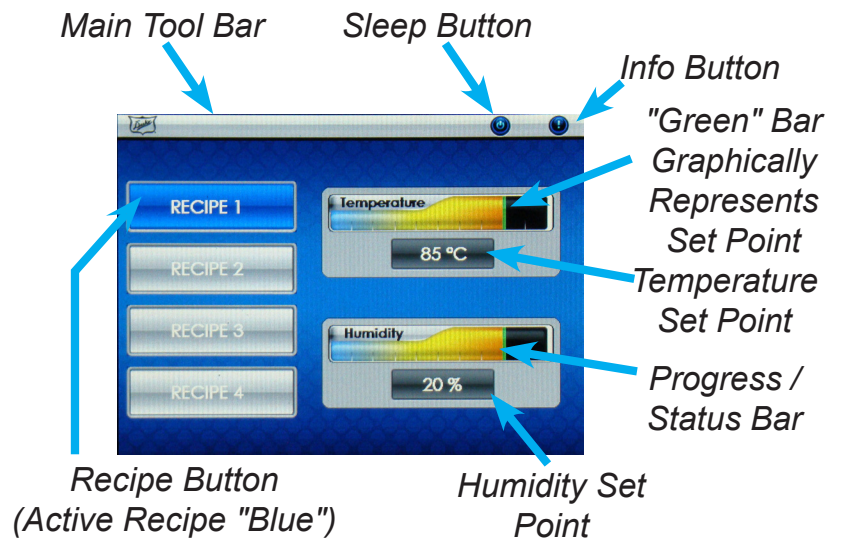

Ready Idle Screen



AUDIBLE ALARMS

The FTU has various audible alarms.

1 chirp	Keystroke acknowledgement
3 short chirps	FTU up to temperature notification
3 beeps (Continuous every 2 min. until cleared)	Check Doors Alarm

DAILY START-UP

1. Verify power cord is connected.
2. Verify RO System is installed, water line is connected and shutoff valve to the unit is open.
3. Check the door seals and make sure both doors close completely and are firmly closed.
4. Place the main switch located on the upper right side of the unit to the ON position. The Boot Screen is displayed and automatically transitions to the Main Screen.
5. The Recipe 1 button will turn to a BLUE background (the remaining Recipe buttons will be GRAY). The unit will start preheating. You may select an alternate Recipe at any time.

During PREHEAT, the display will show actual cavity temperature and humidity (with an orange background).

NOTE: The unit will not attempt to humidify the cabinet until it is 27°F (15°C) below set point. Additionally, at the same time, a 10 min. (or until the set point is reached) SOAK CYCLE is initiated to equalize the cabinet and to control the temperature overshoot from the residual heat of the main elements.

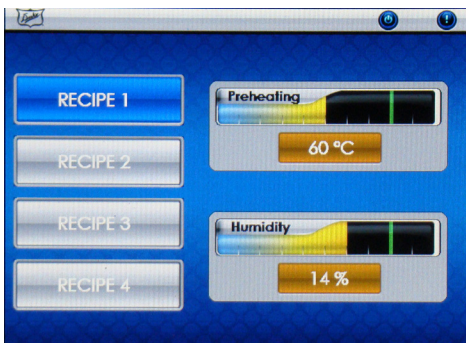

INTERIOR SURFACES ARE HOT AND COOL SLOWLY.

USE PROPER GLOVE PROTECTION TO HANDLE.

6. Check to make sure that the circulating fan and humidification motor are running. Using caution as the surface may be hot, raise the lower spillage pan. Visually confirm the motors were running as they coast to a stop (live components are disabled with the spillage pan removed). Replace spillage pan and close doors firmly.
7. Allow the unit to reach set point temperature prior to use. An audible alarm will sound (3 short chirps) when the unit reaches the READY state. The display will now show the Recipe set points for temperature and humidity (with a gray background).



8. If the unit does not power up correctly or if the doors do not close and seal properly, call Duke for assistance.

NOTE: The stacked units have two power cords, one common water line, and two main switches that will need to be turned to the ON position.

OPERATING INSTRUCTIONS

1. Once the unit reaches the selected Recipe set point, it is then in a READY state and may be used.
2. During this READY state (normal RUN mode), the temperature and humidity are controlled to the recipe set points.
3. After 30 seconds of stable conditions and no button presses, the display will switch to the READY IDLE screen.



4. The display will switch back to the READY RUN screen if any of the following occur:
 - a. The temperature drops below 10% of set-point. In this case, the actual temperature will be displayed (with an orange background) until the temperature recovers to set point.
 - b. An OPEN DOOR condition is detected. In this case, the actual humidity will be displayed (with an orange background) until the OPEN DOOR condition is cleared and the humidity recovers to set point.

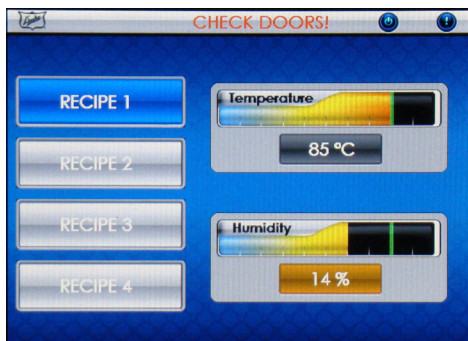

NOTE: An OPEN DOOR condition is detected when the humidity drops 5% below set point and fails to recover within 2 minutes. Once detected, a CHECK DOOR! message will be displayed and after every additional 2 minutes a 3 beep alarm will sound until the unit recovers.

- c. The BACK button is touched.

SHUTDOWN INSTRUCTIONS

1. Place the Main Switch in the "STANDBY" position.

NOTE: The stacked units have two main switches that will need to be turned to the "STANDBY" position.

2. Turn off water at the shutoff valve to the unit.
3. Turn off the main switch on the RO system and turn off water at the mains water supply to the RO system.
4. Open all doors after the unit is turned off to take the pressure off the door gaskets (this will help extend the life of the door gaskets).
5. After approximately 30 minutes, the unit has cooled enough to wipe down the interior of the cabinet using store approved cleaning procedures.

NOTE: If the unit is to be moved for cleaning, verify that the power cord (cords, if stacked) have been disconnected and the water line has been disconnected.

CARE AND CLEANING

WARNING

THE MAIN SWITCH ON THE APPLIANCE IS FOR STANDBY POWER ONLY.

FOR ALL-POLE DISCONNECT REMOVE PLUG FROM WALL OUTLET.

WARNING

INTERIOR, RACKS AND ELEMENTS ARE VERY HOT AND COOL SLOWLY.

ALLOW TO COOL BEFORE HANDLING.

CAUTION

ELECTRICAL SHOCK HAZARD:

DO NOT WASH WITH WATER JET OR HOSE.

CAUTION

DO NOT USE OVEN CLEANERS, CAUSTIC CLEANERS, DEGREASERS, ACIDS, AMMONIA PRODUCTS, ABRASIVE CLEANERS, STEEL WOOL, OR ABRASIVE PADS CONTAINING IRON. THESE CAN DAMAGE THE STAINLESS STEEL, DOOR GASKETS AND PLASTIC SURFACES.

DAILY CLEANING INSTRUCTIONS

1. Verify or place the Main Switch in the "STANDBY" position.
2. Disconnect power by removing plug from the wall outlet.

3. Clean stainless steel exterior with stainless steel cleaner or polish, or with hot soapy water followed by a clean water rinse.
4. Clean glass doors with a glass cleaner.
5. Remove all components in the order as shown for cleaning. Repeat components 1, 2, and 3 for opposite side.

NOTE: Components 1, 2, and 3 are easily removed by slightly lifting and rotating the bottom towards the center of the cavity.

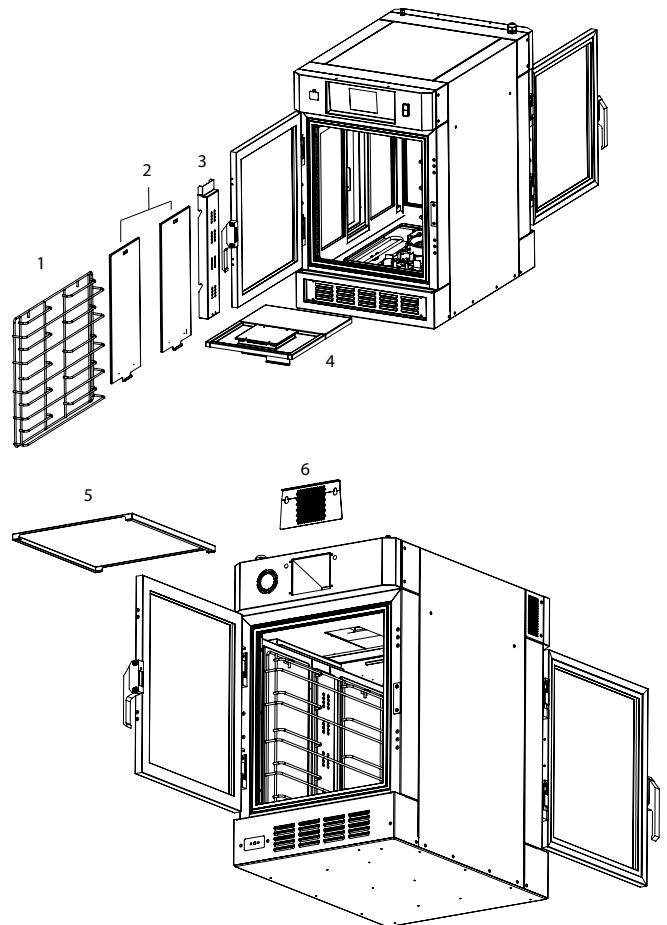

6. Clean all removed components and accessible interior surfaces with a damp cloth. If heavy soil areas exist, clean with hot soapy water and follow with clean damp cloth.

CAUTION

THE TEMPERATURE PROBE SENSOR AND HUMIDITY SENSOR ON THE LEFT SIDE WALL CAN BE DAMAGED BY IMPACT OR BENDING AND SATURATION WITH WATER OR CLEANING FLUIDS.

USE CARE TO NOT DAMAGE OR INTRODUCE WATER / CLEANING FLUIDS DIRECTLY ONTO THE SENSORS.

7. Replace all components in reverse order.

NOTE: The orientation of component 5 is critical in the proper operation of the unit. Make sure the 'flat' side of the vent cover is facing upward and in contact with the top of the cavity (as shown).

WEEKLY CLEANING AND CARE INSTRUCTIONS

HUMIDIFICATION SYSTEM CLEANING

NOTICE Any degree of hard water will leave a lime scale residue on the sides and bottom of the humidification cylinder and on the water atomization disc. This residue will accumulate over time and continually decrease the effectiveness of the system. If this accumulation is significant enough, the humidification system may be rendered inoperable.

Your unit is fitted with a Reverse Osmosis (RO) system that should remove all lime scale from the water supply. As a result, there should not be any accumulation of lime scale on the humidification cylinder. However, any other airborne particles or grease-laden air may be deposited as particles on the cylinder wall. Therefore, we strongly recommend that you clean the humidification cylinder on a weekly basis.

CAUTION

THE HUMIDIFICATION CYLINDER WILL BE HOT WELL AFTER THE INTERIOR SURFACES HAVE COOLED TO ROOM TEMPERATURE.

PLEASE ALLOW SUFFICIENT TIME (APPROXIMATELY 20 TO 30 MINUTES) AFTER REMOVING THE BOTTOM PANEL FOR THE HUMIDIFICATION CYLINDER TO ALSO COOL TO ROOM TEMPERATURE.

CAUTION

TAKE CARE NOT TO DAMAGE THE SILICONE WATER ATOMIZATION DISC OR SHIFT THE POSITION OF THE WATER DELIVERY TUBE. DOING SO WILL AFFECT THE PERFORMANCE AND EFFICIENCY OF THE HUMIDIFICATION SYSTEM.

1. Verify or place the Main Switch in the "STANDBY" position.
2. Disconnect power by removing plug from the wall outlet.

3. Turn off water at the shutoff valve to the unit.
4. Remove the bottom pan to access the humidification system.



5. Wet a towel with warm water and wipe the sides and bottom of the humidification cylinder and the top side of the atomization disc to remove any soilage and/or all of the scale residue. In order to clean the cylinder surface underneath the atomization disc, gently grasp the edge of the disc and curl it upwards.



6. Make sure to remove any soilage and/or all of the scale residue from the sides and bottom of the cylinder and from the top of the atomization disc. If the wetted towel alone is not sufficient to remove the residue from the cylinder, then a scouring pad may be used. **DO NOT** use the scouring pad on the silicone atomization disc.
7. Once the cylinder and atomization disc are free of any soilage and/or scale, wipe all of the surfaces with a clean towel wetted with potable water.
8. Reinstall the bottom pan.

DOOR AND GASKET INSPECTION

1. Inspect door gaskets for cuts, tears or any other damage.
2. Check the door to gasket fit for gaps / leaks and proper sealing.
3. Check the door handles screws for tightness.

NOTE: Refer to the section on DOOR ADJUSTMENTS AND GASKET MAINTENANCE for directions.

DOOR ADJUSTMENTS AND GASKET MAINTENANCE

DOOR GASKET GAPS / LEAKS

The doors should be checked for leaks every week. The adjustment can be made by following the instructions below. If the door gasket is damaged or compressed permanently, it should be replaced.

1. To check the adjustment, close the door with a currency bill between the door and the gasket. Resistance should be felt when pulling the currency bill out with the door closed. Do this check in several places and readjust the door as necessary.

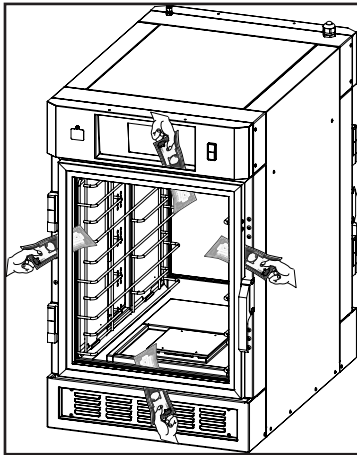

2. With the door closed, remove the hinge covers with a screwdriver and loosen the 2 screws per hinge that hold the hinge body to the door.

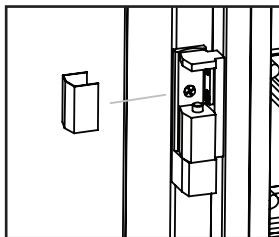

3. Adjust the door position by moving the door frame in or out to seal any gaps between the door and the gasket. Adjustment is made using the screws on the handle and the hinges.

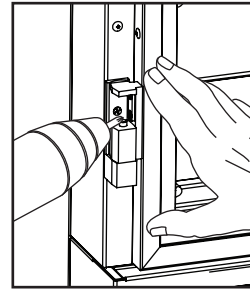

4. To check the adjustment, close the door with a currency bill between the door and the gasket. Resistance should be felt when pulling the currency bill out with the door closed. Do this check in several places and readjust the door, if necessary.

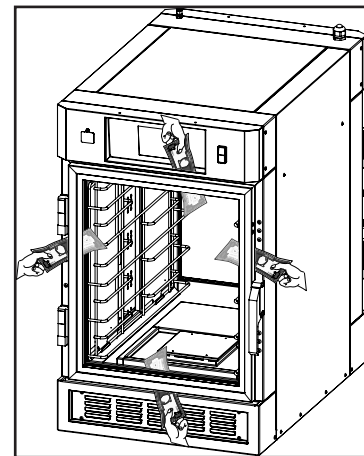

REVERSING UNIT DOOR SWING DIRECTION

1. Open the door approximately 135 degrees. Lift the door off of the hinge.
2. Disassemble door as follows:
 - a. Remove cover from hinges to expose the screws that hold the hinge to the door.
 - b. Taking care to keep the screws matched with the associated hardware, remove the hinges and the door latch handle from the door.
 - c. Remove the screws (filling holes) from the desired hinge side mounting.

3. Reassemble the door as follows:
 - a. Reinstall the hinges and door latch handle with the screws matched with the associated hardware.
 - b. Reinstall screws (filling holes) in original hinge mounting holes (now unused) and replace the hinge covers.
4. Follow the same procedure to reverse the hinge components and the latch strike plate on the unit.
5. The door hinges have cams so they are self closing. Being careful to not damage or score the plastic cams, using either a small screwdriver (to pry) or a pair of pliers (to lift), remove the plastic cams and rotate them 180 degrees and reassemble to the hinges. The doors will now be self closing with the opposite swing direction.
6. Holding the door in a position approximately 135 degrees open, carefully reassemble the door to the cabinet hinges.
7. Adjust the door gasket seal.

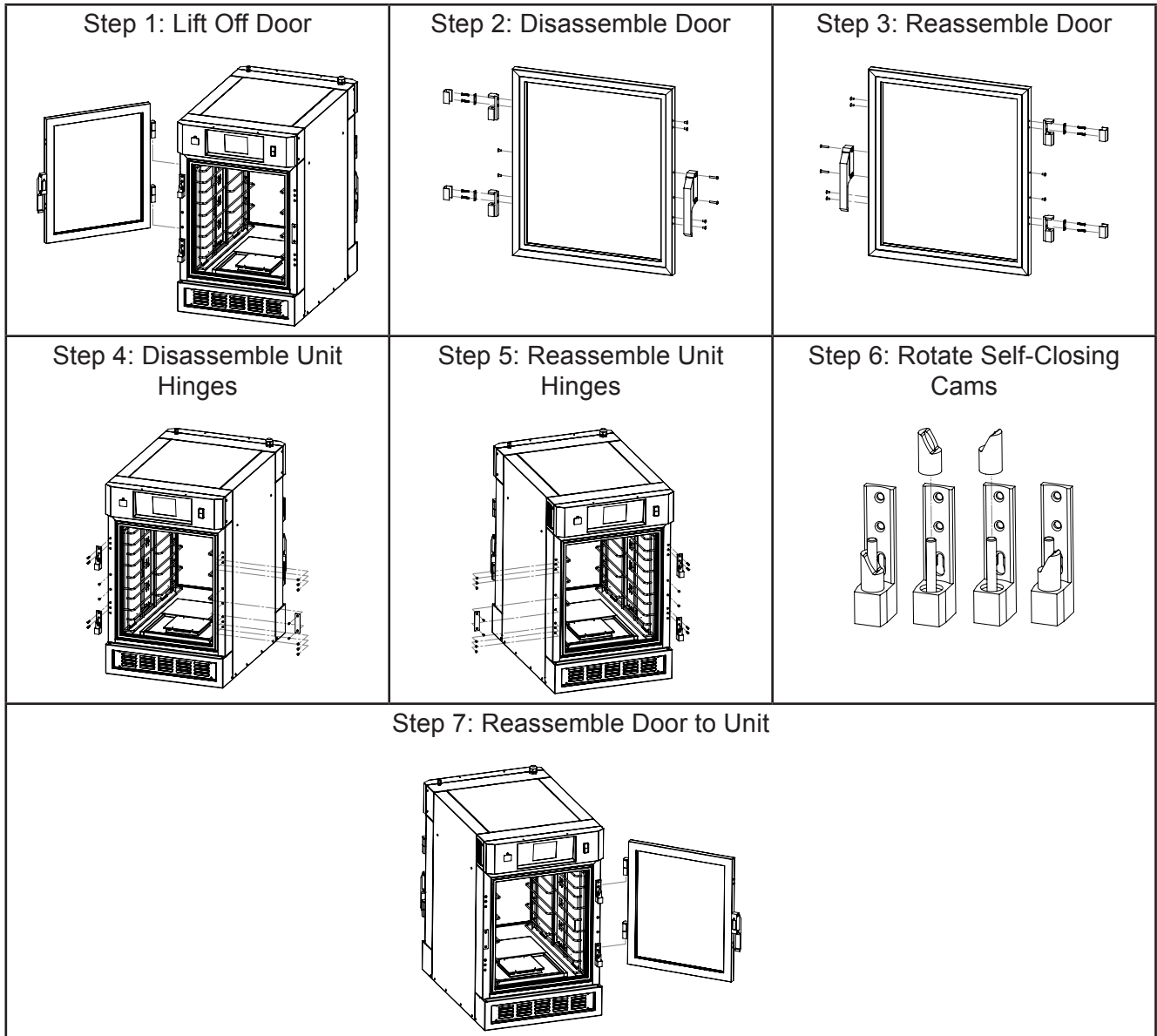

PROGRAMMING CONTROLS

To access the SPECIAL FUNCTIONS, touch  button on the Main Tool Bar.





Figure: Main Tool Bar



Figure: Special Functions Screen

RECIPE EDIT PROGRAMMING INSTRUCTIONS

1. Touch the  button and then enter pin code 5 6 7 8 and Touch the  button when prompted.





2. Touch the button for the recipe you want to edit (i.e. .



FIGURE: Recipe Edit Selection Screen

3. To edit any of the recipe settings, touch the  or  button adjacent to the field you want to change. Touch the  button to save the changes.



NOTE: You must touch the  button in each field to save the changes you made.











Figure: Recipe Edit Screen

4. To edit the recipe name, touch the  button for the EDIT RECIPE NAME screen.

NOTE: Typing will add letters/characters to the end of the text.

PRESS:

-  **TO TOGGLE THE KEYBOARD BETWEEN THE UPPER/LOWER CASE CHARACTER SET.**
- ,  AND  **FOR THE NUMBER AND SYMBOL KEYBOARDS.**
-  **TO SPACE**
-  **TO CLEAR ALL TEXT**
-  **TO DELETE/BACKSPACE**

5. Touch the  button to save the changes and return to the RECIPE EDIT Screen. If no changes are required touch the  button to go back to the RECIPE EDIT Screen.

NOTE: You must touch the  button to save the changes you made.

6. When complete, touch the  button to go back to the previous screen. Press multiple times to return to the main screen.



Figure: Edit Recipe Name Screen

CONFIG (CONFIGURATIONS)







1. Touch the  button and then enter pin code 2 3 4 5 and Touch the  button when prompted.
2. Touch the button for the setting you want to edit.
 - DATE/TIME – Touching will display DATE/TIME edit screen. Touch the  or  button adjacent to the field you want to change. Touch the  button to save the changes.
 - LANGUAGE – Touching will display a list of included languages. Touch the preferred language button to select.
 - C/F SELECT – Touching will toggle between CENTIGRADE MODE ENABLED and FAHRENHEIT MODE ENABLED.
 - DEFAULT RECIPE – Touching will reload factory defaults.
 - SYSTEM STATUS – Touching will display Proofer Oven status.



Figure: Configurations Screen

FILES (FILE MANAGEMENT)

1. Touch the  button and then enter pin code 3 4 5 6 and Touch the  button when prompted.
2. Insert USB drive with the file, until seated, into the USB Host Device.

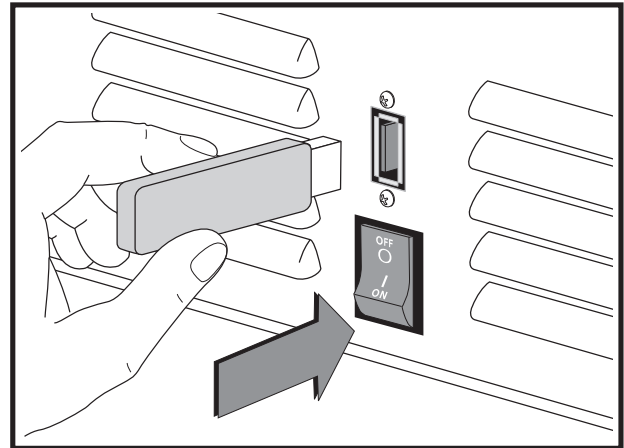

Figure: Inserting USB Drive Into USB Host Device

3. Select file operation from list and follow instruction on the display screen.



Figure: File Management Screen

TROUBLESHOOTING

Problem	Possible Cause	Solution
Unit is not ON	Unit is not connected to power	Connect power cord to the electrical power source
	Main Switch is not ON	Turn switch ON
	Supply Circuit Breaker is tripped	Reset breaker
	Defective ON/OFF switch	Call Duke Service
	Defective Touchscreen Controller	Call Duke Service
Unit is ON but not heating	Recipe temperature set too low	Adjust recipe temperature
	Hi-Limit Switch is tripped	Reset Hi-Limit Switch
	Defective heater element	Call Duke Service
	Defective RTD	Call Duke Service
	Defective Touchscreen Controller	Call Duke Service
Unit is ON and heating but not reaching set point temperature	Doors not closed	Close doors
	Door gaskets not sealing	Inspect for obstructions. Adjust as needed.
	Internal duct or vent panels missing or incorrectly installed	Properly install all components
	Defective Touchscreen Controller	Call Duke Service.
	Defective RTD	Call Duke Service
Unit is ON but not humidifying	Water is turned OFF	Turn ON water
	Water line is blocked	Confirm water to unit
	Doors not closed	Close doors
	Door gaskets not sealing	Inspect for obstructions. Adjust as needed.
	Internal duct or vent panels missing or incorrectly installed	Properly install all components
	Defective humidification heater, motor, or valve	Call Duke Service
	Defective Touchscreen Controller	Call Duke Service

Problem	Possible Cause	Solution
Unit is ON and humidifying but not reaching set point humidity	Water line is restricted	Confirm consistent water to unit
	Doors not closed	Close doors
	Door gaskets not sealing	Inspect for obstructions. Adjust as needed.
	Internal duct or vent panels missing or incorrectly installed	Properly install all components
	Defective humidification heater, motor, or valve	Call Duke Service
Inconsistent cabinet temperature and or humidity	Incorrect Recipe Settings for Vent ON/OFF	Adjust Vent ON/OFF to tighter tolerance of set point (Vent OFF at 1% above set point to prevent overshoot)
	Internal duct or vent panels missing or incorrectly installed	Properly install all components
	Pans not fully loaded into the cabinet	Install pans at each tray level and positionally center the pans in all directions.
	Doors opened for extended times	Immediately close doors after selecting product
	Defective components	Call Duke Service

A Manually reset high temperature safety limit is provided on the lower right back of the unit to protect the main elements. The high limit will not trip under normal operating conditions. Should the high limit trip, push the RESET button. The high limit will reset with a "click" if an over temperature trip occurred. If condition persists, call Duke Service.

HIGH LIMIT PROTECTOR FOR MAIN ELEMENTS

Located on lower right back of unit

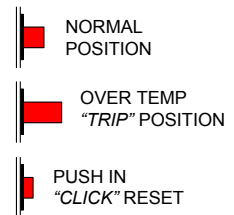

WIRING DIAGRAM

P/N 169694

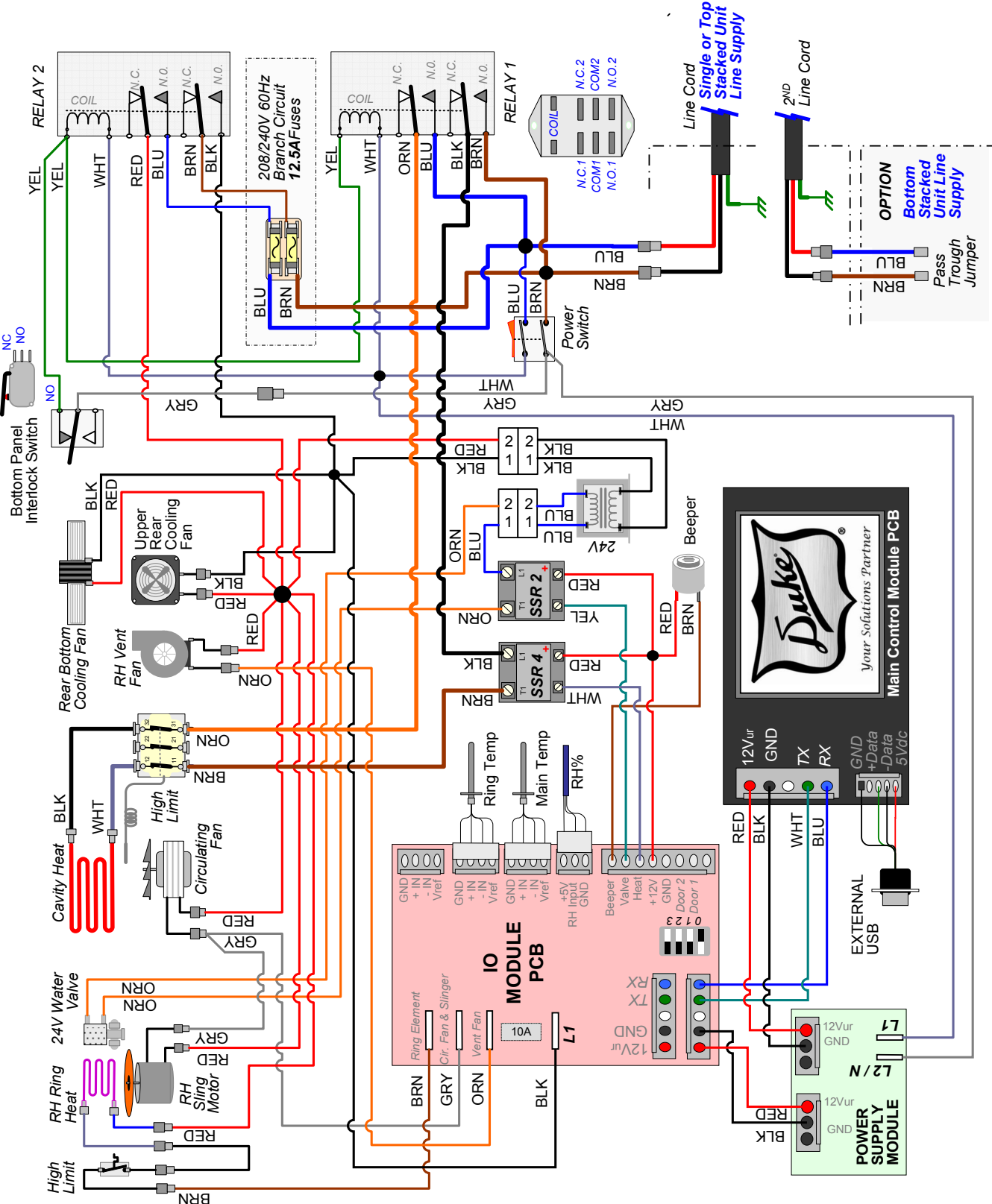



Your Solutions Partner

Duke Manufacturing Co.

2305 N. Broadway
St. Louis, MO 63102
Phone: 314-231-1130
Toll Free: 1-800-735-3853
Fax: 314-231-5074

www.dukemfg.com