

USER GUIDE

FM-750™ Display

Version 1.00
Revision A
November 2010



Agriculture Business Area

Trimble Navigation Limited
Trimble Agriculture Division
10355 Westmoor Drive
Suite #100
Westminster, CO 80021
USA

trimble_support@trimble.com
www.trimble.com

Legal Notices

Copyright and Trademarks

© 2010, Trimble Navigation Limited. All rights reserved.

Trimble, the Globe & Triangle logo, AgGPS, EZ-Boom, EZ-Guide, EZ-Steer, FmX, and Tru Count are trademarks of Trimble Navigation Limited, registered in the United States and in other countries.

Autopilot, AutoSeed, AutoSense, FM-750, EZ-Office, FieldManager, Field-IQ, FreeForm, VRS, VRS Now, T2, Tru Application Control, TrueGuide, and TrueTracker are trademarks of Trimble Navigation Limited.

GreenSeeker is a registered trademark of NTech Ltd.

For STL support, the software uses the Moscow Center for SPARC Technology adaptation of the SGI Standard Template Library. Copyright © 1994 Hewlett-Packard Company, Copyright © 1996, 97 Silicon Graphics Computer Systems, Inc., Copyright © 1997 Moscow Center for SPARC Technology.

Microsoft, Windows, ActiveX, Excel, and Internet Explorer are either registered trademarks or trademarks of Microsoft Corporation in the United States and/or other countries.

Portions Copyright (c) 2009 Nokia Corporation and/or its subsidiary(-ies).

Portions Copyright (c) 2003, Bitstream Inc.

All other trademarks are the property of their respective owners.

Release Notice

This is the November 2010 release (Version 4.0, Revision A) of the *FM-750 Display User Guide*. It applies to version 1.00 of the FM-750 display software.

Legal Notices

The following limited warranties give you specific legal rights. You may have others, which vary from state/jurisdiction to state/jurisdiction.

Product Limited Warranty

Trimble warrants that this Trimble product and its internal components (the "Product") shall be free from defects in materials and workmanship and will substantially conform to Trimble's applicable published specifications for the Product for a period of one (1) year, starting from the earlier of (i) the date of installation, or (ii) six (6) months from the date of original Product shipment from Trimble. This warranty applies only to the Product if installed by Trimble or a dealer authorized by Trimble to perform Product installation services.

Software Components

All Product software components (sometimes hereinafter also referred to as "Software") are licensed solely for use as an integral part of the Product and are not sold. Any software accompanied by a separate end user license agreement ("EULA") shall be governed by the terms, conditions, restrictions and limited warranty terms of such EULA notwithstanding the preceding paragraph.

During the limited warranty period you will be entitled to receive such Fixes to the Product software that Trimble releases and makes commercially available and for which it does not charge separately, subject to the procedures for delivery to purchasers of Trimble products generally. If you have purchased the Product from an authorized Trimble dealer rather than from Trimble directly, Trimble may, at its option, forward the software Fix to the Trimble dealer for final distribution to you. Minor Updates, Major Upgrades, new products, or substantially new software releases, as identified by Trimble, are expressly excluded from this update process and limited warranty. Receipt of software Fixes or other enhancements shall not serve to extend the limited warranty period.

For purposes of this warranty the following definitions shall apply: (1) "Fix(es)" means an error correction or other update created to fix a previous software version that does not substantially conform to its Trimble specifications; (2) "Minor Update" occurs when enhancements are made to current features in a software program; and (3) "Major Upgrade" occurs when significant new features are added to software, or when a new product containing new features replaces the further development of a current product line. Trimble reserves the right to determine, in its sole discretion, what constitutes a Fix, Minor Update, or Major Upgrade.

This Trimble software contains Qt 4.5 libraries licensed under the GNU Lesser General Public License (LGPL). The source is available from <http://qt.nokia.com/downloads>. A copy of the LGPL license is included in the appendices of this manual, and at ftp://ftp.trimble.com/pub/open_source/FmX.

This software includes the DejaVu fonts, which are licensed under the Bitstream Vera license, terms available at <http://dejavu-fonts.org/wiki/index.php?title=License> and <http://www.gnome.org/fonts/>.

GNU LESSER GENERAL PUBLIC LICENSE

Version 2.1, February 1999

Copyright © 1991, 1999 Free Software Foundation, Inc.
51 Franklin Street, Fifth Floor, Boston, MA 02110-1301
USA

Everyone is permitted to copy and distribute verbatim copies of this license document, but changing it is not allowed. [This is the first released version of the Lesser GPL. It also counts as the successor of the GNU Library Public License, version 2, hence the version number 2.1.]

Preamble

The licenses for most software are designed to take away your freedom to share and change it. By contrast, the GNU General Public Licenses are intended to guarantee your freedom to share and change free software-to make sure the software is free for all its users.

This license, the Lesser General Public License, applies to some specially designated software packages-typically libraries-of the Free Software Foundation and other authors who decide to use it. You can use it too, but we suggest you first think carefully about whether this license or the ordinary General Public License is the better strategy to use in any particular case, based on the explanations below.

When we speak of free software, we are referring to freedom of use, not price. Our General Public Licenses are designed to make sure that you have the freedom to distribute copies of free software (and charge for this service if you wish); that you receive source code or can get it if you want it; that you can change the software and use pieces of it in new free programs; and that you are informed that you can do these things.

To protect your rights, we need to make restrictions that forbid distributors to deny you these rights or to ask you to surrender these rights. These restrictions translate to certain responsibilities for you if you distribute copies of the library or if you modify it.

For example, if you distribute copies of the library, whether gratis or for a fee, you must give the recipients all the rights that we gave you. You must make sure that they, too, receive or can get the source code. If you link other code with the library, you must provide complete object files to the recipients, so that they can relink them with the library after making changes to the library and recompiling it. And you must show them these terms so they know their rights.

We protect your rights with a two-step method: (1) we copyright the library, and (2) we offer you this license, which gives you legal permission to copy, distribute and/or modify the library.

To protect each distributor, we want to make it very clear that there is no warranty for the free library. Also, if the library is modified by someone else and passed on, the recipients should know that what they have is not the original version, so that the original author's reputation will not be affected by problems that might be introduced by others.

Finally, software patents pose a constant threat to the existence of any free program. We wish to make sure that a company cannot effectively restrict the users of a free program by obtaining a restrictive license from a patent holder. Therefore, we insist that any patent license obtained for a version of the library must be consistent with the full freedom of use specified in this license.

Most GNU software, including some libraries, is covered by the ordinary GNU General Public License. This license, the GNU Lesser General Public License, applies to certain designated libraries, and is quite different from the ordinary General Public License. We use this license for certain libraries in order to permit linking those libraries into non-free programs.

When a program is linked with a library, whether statically or using a shared library, the combination of the two is legally speaking a combined work, a derivative of the original library. The ordinary General Public License therefore permits such linking only if the entire combination fits its criteria of freedom. The Lesser General Public License permits more lax criteria for linking other code with the library.

We call this license the "Lesser" General Public License because it does Less to protect the user's freedom than the ordinary General Public License. It also provides other free software developers Less of an advantage over competing non-free programs. These disadvantages are the reason we use the ordinary General Public License for many libraries. However, the Lesser license provides advantages in certain special circumstances.

For example, on rare occasions, there may be a special need to encourage the widest possible use of a certain library, so that it becomes a de-facto standard. To achieve this, non-free programs must be allowed to use the library. A more frequent case is that a free library does the same job as widely used non-free libraries. In this case, there is little to gain by limiting the free library to free software only, so we use the Lesser General Public License.

In other cases, permission to use a particular library in nonfree programs enables a greater number of people to use a large body of free software. For example, permission to use the GNU C Library in non-free programs enables many more people to use the whole GNU operating system, as well as its variant, the GNU/Linux operating system.

Although the Lesser General Public License is Less protective of the users' freedom, it does ensure that the user of a program that is linked with the Library has the freedom and the wherewithal to run that program using a modified version of the Library.

The precise terms and conditions for copying, distribution and modification follow. Pay close attention to the difference between a "work based on the library" and a "work that uses the library". The former contains code derived from the library, whereas the latter must be combined with the library in order to run.

GNU LESSER GENERAL PUBLIC LICENSE

TERMS AND CONDITIONS FOR COPYING, DISTRIBUTION AND MODIFICATION

0. This License Agreement applies to any software library or other program which contains a notice placed by the copyright holder or other authorized party saying it may be distributed under the terms of this Lesser General Public License (also called "this License"). Each licensee is addressed as "you".

A "library" means a collection of software functions and/or data prepared so as to be conveniently linked with application programs (which use some of those functions and data) to form executables.

The "Library", below, refers to any such software library or work which has been distributed under these terms. A "work based on the Library" means either the Library or any derivative work under copyright law; that is to say, a work containing the Library or a portion of it, either verbatim or with modifications and/or translated straightforwardly into another language. (Hereinafter, translation is included without limitation in the term "modification".)

"Source code" for a work means the preferred form of the work for making modifications to it. For a library, complete source code means all the source code for all modules it contains, plus any associated interfacedefinition files, plus the scripts used to control compilation and installation of the library.

Activities other than copying, distribution and modification are not covered by this License; they are outside its scope. The act of running a program using the Library is not restricted, and output from such a program is covered only if its contents constitute a work based on the Library (independent of the use of the Library in a tool for writing it). Whether that is true depends on what the Library does and what the program that uses the Library does.

1. You may copy and distribute verbatim copies of the Library's complete source code as you receive it, in any medium, provided that you conspicuously and appropriately publish on each copy an appropriate copyright notice and disclaimer of warranty; keep intact all the notices that refer to this License and to the absence of any warranty; and distribute a copy of this License along with the Library.

You may charge a fee for the physical act of transferring a copy, and you may at your option offer warranty protection in exchange for a fee.

2. You may modify your copy or copies of the Library or any portion of it, thus forming a work based on the Library, and copy and distribute such modifications or work under the terms of Section 1 above, provided that you also meet all of these conditions:

- The modified work must itself be a software library.
- You must cause the files modified to carry prominent notices stating that you changed the files and the date of any change.
- You must cause the whole of the work to be licensed at no charge to all third parties under the terms of this License.
- If a facility in the modified Library refers to a function or a table of data to be supplied by an application program that uses the facility, other than as an argument passed when the facility is invoked, then you must make a good faith effort to ensure that, in the event an application does not supply such function or table, the facility still operates, and performs whatever part of its purpose remains meaningful.

(For example, a function in a library to compute square roots has a purpose that is entirely well-defined independent of the application. Therefore, Subsection 2d requires that any application-supplied function or table used by this function must be optional: if the application does not supply it, the square root function must still compute square roots.)

These requirements apply to the modified work as a whole. If identifiable sections of that work are not derived from the Library, and can be reasonably considered independent and separate works in themselves, then this License, and its terms, do not apply to those sections when you distribute them as separate works. But when you distribute the same sections as part of a whole which is a work based on the Library, the distribution of the whole must be on the terms of this License, whose permissions for other licensees extend to the entire whole, and thus to each and every part regardless of who wrote it.

Thus, it is not the intent of this section to claim rights or contest your rights to work written entirely by you; rather, the intent is to exercise the right to control the distribution of derivative or collective works based on the Library.

In addition, mere aggregation of another work not based on the Library with the Library (or with a work based on the Library) on a volume of a storage or distribution medium does not bring the other work under the scope of this License.

3. You may opt to apply the terms of the ordinary GNU General Public License instead of this License to a given copy of the Library. To do this, you must alter all the notices that refer to this License, so that they refer to the ordinary GNU General Public License, version 2, instead of to this License. (If a newer version than version 2 of the ordinary GNU General Public License has appeared, then you can specify that version instead if you wish.) Do not make any other change in these notices.

Once this change is made in a given copy, it is irreversible for that copy, so the ordinary GNU General Public License applies to all subsequent copies and derivative works made from that copy.

This option is useful when you wish to copy part of the code of the Library into a program that is not a library.

4. You may copy and distribute the Library (or a portion or derivative of it, under Section 2) in object code or executable form under the terms of Sections 1 and 2 above provided that you accompany it with the complete corresponding machine-readable source code, which must be distributed under the terms of Sections 1 and 2 above on a medium customarily used for software interchange.

If distribution of object code is made by offering access to copy from a designated place, then offering equivalent access to copy the source code from the same place satisfies the requirement to distribute the source code, even though third parties are not compelled to copy the source along with the object code.

5. A program that contains no derivative of any portion of the Library, but is designed to work with the Library by being compiled or linked with it, is called a "work that uses the Library". Such a work, in isolation, is not a derivative work of the Library, and therefore falls outside the scope of this License.

However, linking a "work that uses the Library" with the Library creates an executable that is a derivative of the Library (because it contains portions of the Library), rather than a "work that uses the library". The executable is therefore covered by this License. Section 6 states terms for distribution of such executables.

When a "work that uses the Library" uses material from a header file that is part of the Library, the object code for the work may be a derivative work of the Library even though the source code is not. Whether this is true is especially significant if the work can be linked without the Library, or if the work is itself a library. The threshold for this to be true is not precisely defined by law.

If such an object file uses only numerical parameters, data structure layouts and accessors, and small macros and small inline functions (ten lines or less in length), then the use of the object file is unrestricted, regardless of whether it is legally a derivative work. (Executables containing this object code plus portions of the Library will still fall under Section 6.)

Otherwise, if the work is a derivative of the Library, you may distribute the object code for the work under the terms of Section 6. Any executables containing that work also fall under Section 6, whether or not they are linked directly with the Library itself.

6. As an exception to the Sections above, you may also combine or link a "work that uses the Library" with the Library to produce a work containing portions of the Library, and distribute that work under terms of your choice, provided that the terms permit modification of the work for the customer's own use and reverse engineering for debugging such modifications.

You must give prominent notice with each copy of the work that the Library is used in it and that the Library and its use are covered by this License. You must supply a copy of this License. If the work during execution displays copyright notices, you must include the copyright notice for the Library among them, as well as a reference directing the user to the copy of this License. Also, you must do one of these things:

- Accompany the work with the complete corresponding machine-readable source code for the Library including whatever changes were used in the work (which must be distributed under Sections 1 and 2 above); and, if the work is an executable linked with the Library, with the complete machine-readable "work that uses the Library", as object code and/or source code, so that the user can modify the Library and then relink to produce a modified executable containing the modified Library. (It is understood that the user who changes the contents of definitions files in the Library will not necessarily be able to recompile the application to use the modified definitions.)
- Use a suitable shared library mechanism for linking with the Library. A suitable mechanism is one that (1) uses at run time a copy of the library already present on the user's computer system, rather than copying library functions into the executable, and (2) will operate properly with a modified version of the library, if the user installs one, as long as the modified version is interface-compatible with the version that the work was made with.
- Accompany the work with a written offer, valid for at least three years, to give the same user the materials specified in Subsection 6a, above, for a charge no more than the cost of performing this distribution.
- If distribution of the work is made by offering access to copy from a designated place, offer equivalent access to copy the above specified materials from the same place.
- Verify that the user has already received a copy of these materials or that you have already sent this user a copy.

For an executable, the required form of the "work that uses the Library" must include any data and utility programs needed for reproducing the executable from it. However, as a special exception, the materials to be distributed need not include anything that is normally distributed (in either source or binary form) with the major components (compiler, kernel, and so on) of the operating system on which the executable runs, unless that component itself accompanies the executable.

It may happen that this requirement contradicts the license restrictions of other proprietary libraries that do not normally accompany the operating system. Such a contradiction means you cannot use both them and the Library together in an executable that you distribute.

7. You may place library facilities that are a work based on the Library side-by-side in a single library together with other library facilities not covered by this License, and distribute such a combined library, provided that the separate distribution of the work based on the Library and of the other library facilities is otherwise permitted, and provided that you do these two things:

- a) Accompany the combined library with a copy of the same work based on the Library, uncombined with any other library facilities. This must be distributed under the terms of the Sections above.
- b) Give prominent notice with the combined library of the fact that part of it is a work based on the Library, and explaining where to find the accompanying uncombined form of the same work.
8. You may not copy, modify, sublicense, link with, or distribute the Library except as expressly provided under this License. Any attempt otherwise to copy, modify, sublicense, link with, or distribute the Library is void, and will automatically terminate your rights under this License. However, parties who have received copies, or rights, from you under this License will not have their licenses terminated so long as such parties remain in full compliance.
9. You are not required to accept this License, since you have not signed it. However, nothing else grants you permission to modify or distribute the Library or its derivative works. These actions are prohibited by law if you do not accept this License. Therefore, by modifying or distributing the Library (or any work based on the Library), you indicate your acceptance of this License to do so, and all its terms and conditions for copying, distributing or modifying the Library or works based on it.
10. Each time you redistribute the Library (or any work based on the Library), the recipient automatically receives a license from the original licensor to copy, distribute, link with or modify the Library subject to these terms and conditions. You may not impose any further restrictions on the recipients' exercise of the rights granted herein. You are not responsible for enforcing compliance by third parties with this License.

Warranty Remedies

Trimble's sole liability and your exclusive remedy under the warranties set forth above shall be, at Trimble's option, to repair or replace any Product that fails to conform to such warranty ("Nonconforming Product"), and/or issue a cash refund up to the purchase price paid by you for any such Nonconforming Product, excluding costs of installation, upon your return of the Nonconforming Product to Trimble in accordance with Trimble's product return procedures than in effect. Such remedy may include reimbursement of the cost of repairs for damage to third-party equipment onto which the Product is installed, if such damage is found to be directly caused by the Product as reasonably determined by Trimble following a root cause analysis.

Warranty Exclusions and Disclaimer

These warranties shall be applied only in the event and to the extent that (a) the Products and Software are properly and correctly installed, configured, interfaced, maintained, stored, and operated in accordance with Trimble's relevant operator's manual and specifications, and; (b) the Products and Software are not modified or misused. The preceding warranties shall not apply to, and Trimble shall not be responsible for defects or performance problems resulting from (i) the combination or utilization of the Product or Software with hardware or software products, information, data, systems, interfaces or devices not made, supplied or specified by Trimble; (ii) the operation of the Product or Software under any specification other than, or in addition to, Trimble's standard specifications for its products; (iii) the unauthorized, installation, modification, or use of the Product or Software; (iv) damage caused by accident, lightning or other electrical discharge, fresh or salt water immersion or spray (outside of Product specifications); or (v) normal wear and tear on consumable parts (e.g., batteries). Trimble does not warrant or guarantee the results obtained through the use of the Product or that software components will operate error free.

THE WARRANTIES ABOVE STATE TRIMBLE'S ENTIRE LIABILITY, AND YOUR EXCLUSIVE REMEDIES, RELATING TO THE PRODUCTS AND SOFTWARE, EXCEPT AS OTHERWISE EXPRESSLY PROVIDED HEREIN, THE PRODUCTS, SOFTWARE, AND ACCOMPANYING DOCUMENTATION AND MATERIALS ARE PROVIDED "AS IS" AND WITHOUT EXPRESS OR IMPLIED WARRANTY OF ANY KIND BY EITHER TRIMBLE NAVIGATION LIMITED OR ANYONE WHO HAS BEEN INVOLVED IN ITS CREATION, PRODUCTION, INSTALLATION, OR DISTRIBUTION INCLUDING, BUT NOT LIMITED TO, THE IMPLIED WARRANTIES OF MERCHANTABILITY AND FITNESS FOR A PARTICULAR PURPOSE, TITLE, AND NON-INFRINGEMENT. THE STATED EXPRESS WARRANTIES ARE IN LIEU OF ALL OBLIGATIONS OR LIABILITIES ON THE PART OF TRIMBLE ARISING OUT OF, OR IN CONNECTION WITH, ANY PRODUCTS OR SOFTWARE. BECAUSE SOME STATES AND JURISDICTIONS DO NOT ALLOW LIMITATIONS ON DURATION OR THE EXCLUSION OF AN IMPLIED WARRANTY, THE ABOVE LIMITATION MAY NOT APPLY OR FULLY APPLY TO YOU.

NOTICE REGARDING PRODUCTS EQUIPPED WITH TECHNOLOGY CAPABLE OF TRACKING SATELLITE SIGNALS FROM SATELLITE BASED AUGMENTATION SYSTEMS (SBAS) (WAAS/EGNOS, AND MSAS), OMNISTAR, GPS, MODERNIZED GPS OR GLONASS SATELLITES, OR FROM IALA BEACON SOURCES: TRIMBLE IS NOT RESPONSIBLE FOR THE OPERATION OR FAILURE OF OPERATION OF ANY SATELLITE BASED POSITIONING SYSTEM OR THE AVAILABILITY OF ANY SATELLITE BASED POSITIONING SIGNALS.

Limitation of Liability

TRIMBLE'S ENTIRE LIABILITY UNDER ANY PROVISION HEREIN SHALL BE LIMITED TO THE AMOUNT PAID BY YOU FOR THE PRODUCT OR SOFTWARE LICENSE. TO THE MAXIMUM EXTENT PERMITTED BY APPLICABLE LAW, IN NO EVENT SHALL TRIMBLE OR ITS SUPPLIERS BE LIABLE FOR ANY INDIRECT, SPECIAL, INCIDENTAL OR CONSEQUENTIAL DAMAGES WHATSOEVER UNDER ANY CIRCUMSTANCE OR LEGAL THEORY RELATING IN ANY WAY TO THE PRODUCTS, SOFTWARE AND ACCOMPANYING DOCUMENTATION AND MATERIALS, (INCLUDING, WITHOUT LIMITATION, DAMAGES FOR LOSS OF BUSINESS PROFITS, BUSINESS INTERRUPTION, LOSS OF BUSINESS INFORMATION, OR ANY OTHER PECUNIARY LOSS), REGARDLESS WHETHER TRIMBLE HAS BEEN ADVISED OF THE POSSIBILITY OF ANY SUCH LOSS AND REGARDLESS OF THE COURSE OF DEALING WHICH DEVELOPS OR HAS

DEVELOPED BETWEEN YOU AND TRIMBLE. BECAUSE SOME STATES AND JURISDICTIONS DO NOT ALLOW THE EXCLUSION OR LIMITATION OF LIABILITY FOR CONSEQUENTIAL OR INCIDENTAL DAMAGES, THE ABOVE LIMITATION MAY NOT APPLY OR FULLY APPLY TO YOU.

PLEASE NOTE: THE ABOVE TRIMBLE LIMITED WARRANTY PROVISIONS WILL NOT APPLY TO PRODUCTS PURCHASED IN THOSE JURISDICTIONS (E.G., MEMBER STATES OF THE EUROPEAN ECONOMIC AREA) IN WHICH PRODUCT WARRANTIES ARE THE RESPONSIBILITY OF THE LOCAL DEALER FROM WHOM THE PRODUCTS ARE ACQUIRED. IN SUCH A CASE, PLEASE CONTACT YOUR TRIMBLE DEALER FOR APPLICABLE WARRANTY INFORMATION.

Official Language

THE OFFICIAL LANGUAGE OF THESE TERMS AND CONDITIONS IS ENGLISH. IN THE EVENT OF A CONFLICT BETWEEN ENGLISH AND OTHER LANGUAGE VERSIONS, THE ENGLISH LANGUAGE SHALL CONTROL.

Registration

TO RECEIVE INFORMATION REGARDING UPDATES AND NEW PRODUCTS, PLEASE CONTACT YOUR LOCAL DEALER OR VISIT THE TRIMBLE WEBSITE AT www.trimble.com/register. UPON REGISTRATION YOU MAY SELECT THE NEWSLETTER, UPGRADE, OR NEW PRODUCT INFORMATION YOU DESIRE.

Registration

To receive information regarding updates and new products, please contact your local dealer or visit the Trimble website at www.trimble.com/register. Upon registration you may select the newsletter, upgrade or new product information you desire.

Notices

This equipment has been tested and found to comply with the limits for a Class A digital device, pursuant to Part 15 of the FCC rules. These limits are designed to provide reasonable protection against harmful interference when the equipment is operated in a commercial environment. This equipment generates, uses, and can radiate radio frequency energy and, if not installed and used in accordance with the instruction manual, may cause harmful interference to radio communications. Operation of this equipment in a residential area is likely to cause harmful interference, in which case the user will be required to correct the interference at his own expense.

Properly shielded and grounded cables and connectors must be used in order to meet FCC emission limits. TRIMBLE is not responsible for any radio or television interference caused by using other than recommended cables and connectors or by unauthorized changes or modifications to this equipment. Unauthorized changes or modifications could void the user's authority to operate the equipment.

This device complies with Part 15 of the FCC rules. Operation is subject to the following two conditions:

- (1) this device may not cause harmful interference, and (2) this device must accept any interference received, including interference that may cause undesired operation.

Responsible Party:

Trimble Navigation
935 Stewart Drive
Sunnyvale CA 94085
Telephone: 1-408 481 8000

Canada

This Class B digital apparatus complies with Canadian ICES-003.

Cet appareil numérique de la classe B est conforme à la norme NMB-003 du Canada.

This apparatus complies with Canadian RSS-GEN, RSS-310, RSS-210, and RSS-119.

Cet appareil est conforme à la norme CNR-GEN, CNR-310, CNR-210, et CNR-119 du Canada.

Australia and New Zealand Class A Statement

Attention: This is a Class A product. In a domestic environment this product may cause radio interference in which case the user may be required to take adequate measures.

Australia and New Zealand

This product conforms with the regulatory requirements of the Australian Communications Authority (ACA) EMC framework, thus satisfying the requirements for C-Tick Marking and sale within Australia and New Zealand.



Notice to Our European Union Customers

For product recycling instructions and more information, please go to www.trimble.com/ev.shtml.

Recycling in Europe: To recycle Trimble WEEE (Waste Electrical and Electronic Equipment, products that run on electrical power), Call +31 497 53 24 30, and ask for the "WEEE Associate". Or, mail a request for recycling instructions to:

Trimble Europe BV
c/o Menlo Worldwide Logistics
Meerheide 45
5521 DZ Eersel, NL



Safety

Always follow the instructions that accompany a Warning or Caution. The information they provide is intended to minimize the risk of personal injury and/or damage to property. In particular, observe safety instructions that are presented in the following format:



WARNING – This alert warns of a potential hazard which, if not avoided, can cause severe injury.



CAUTION – This alert warns of a hazard or unsafe practice which, if not avoided, can cause injury or damage.

Note – An absence of specific alerts does not mean that there are no safety risks involved.

Warnings



WARNING – Anhydrous ammonia (NH₃) can cause severe burning, blindness, or death. Before you begin to operate or service equipment that contains NH₃, carefully read and follow all safety instructions in [Working with anhydrous ammonia, page 6](#).



WARNING – Incorrect adjustment of the Manual Override Sensitivity calibration setting could cause this critical safety feature to fail, resulting in personal injury or damage to the vehicle. Any adjustment to this setting should only be made by an experienced user.



WARNING – During the Deadzone calibration, the system moves the vehicle's steering wheels. To avoid injury, be prepared for sudden vehicle movement.



WARNING – When you tap the liquid flow calibration **Start** button, the machine will become operational. Take all necessary precautions to ensure user safety. Failure to do so may result in serious injury or death.



WARNING – When you tap the control valve calibration **Start** button, the machine will become operational. Take all necessary precautions to ensure user safety. Failure to do so may result in serious injury or death.



WARNING – When you tap the fill disk **Start** button, the machine will become operational. Take all necessary precautions to ensure user safety. Failure to do so may result in serious injury or death.



WARNING – When the implement is down and the master switch is in the On position, the machine is fully operational. Take all necessary precautions to ensure user safety. Failure to do so could result in injury or death.



WARNING – The display contains a single-use Lithium-sulfide LiSO₂ battery. Do not expose the battery to temperatures greater than 71 °C (160 °F) as the battery may explode.



WARNING – MOVING PARTS DURING THIS TEST! Please stay clear of the implement. Ensure the implement is raised, the transmission is in PARK and the emergency brake is applied before continuing.

Working with anhydrous ammonia

- Contact your NH₃ supplier to review all safety requirements associated with anhydrous ammonia (NH₃).
- Always wear correct personal protective equipment. This includes, but is not limited to:
 - Goggles or face shield
 - Protective suit and gloves
 - Respirator
- **Do not** allow anyone to operate the system without proper instruction and training.
- Stand up-wind when working around NH₃ and related equipment.
- Always keep NH₃ equipment away from buildings, livestock, and other people.
- Never work on NH₃ equipment in confined spaces.
- Before you attempt to transport the implement, discharge the system of all NH₃ and completely shut down the system. See [Discharging the system, page 7](#).
- If symptoms of illness occur during or shortly after use of NH₃ products, seek immediate medical attention.
- Keep a source of clean water (at least five gallons) readily available. In case of exposure, flush exposed skin or eyes immediately with large quantities of water and seek immediate medical attention.
- NH₃ can be harmful to the environment if not used correctly. Follow all local, state, and federal regulations regarding proper handling of this chemical.

Servicing the equipment

1. Remove the system from operation before performing any maintenance.
2. Thoroughly bleed all system lines and disconnect the nurse tank hose. See [Discharging the system, page 7](#).

3. Make sure that the gauge pressure is at zero before you open the system.
4. Use extreme caution when opening a previously pressurized system.

Discharging the system

1. Turn off the console or vehicle master switch.
2. Completely close the main shut-off valve on the supply or nurse tank.
3. Resume field application until the pressure gauge shows zero pressure.
4. Check again that the console and/or vehicle master switch, and all section switches, are turned off.
5. Completely close the emergency shut-off valve the cooling tower.
6. Bleed and disconnect the nurse tank supply hose from the system.
7. Turn on the console master switch and all section switches.
8. Stand up-wind from the implement and then slowly open the bleed valve(s) until fully open.
9. Allow at least one (1) hour for the system to fully discharge.
10. Before you open the system, make sure that the pressure gauge on the manifold reads zero and that the cooling tower is not cold to the touch. This ensures that all liquid NH₃ has evaporated and that the pressure is discharged.

***Note** – Frost on any component is a positive indication of trapped NH₃ at low pressure. Lack of frost does not always indicate a lack of NH₃.*

Contents

Safety	5
Warnings	5
Working with anhydrous ammonia.	6
Servicing the equipment	6
1 Introduction	13
About the product	13
Related information	13
Technical assistance	13
2 Installing the Display and Antenna	15
System components	16
Installing the display	17
Connecting the display	19
Standalone FM-750 / WAAS / EGNOS / OmniSTAR XP/HP corrections	19
Standalone FM-750 / RTK corrections	20
Installing the antenna	21
3 Getting Started.	23
Display basics	24
Cleaning the touchscreen.	26
Power up	26
Power down	27
Resetting the display.	27
The USB socket	28
Removing a USB drive	29
Taking a screenshot	29
The Quick Start Wizard	30
Using the setup wizards.	31
The guidance screen	32
Status	32
Settings	33
View	33
Extended icons	34
Quick Access icon	35
The Field icon	37
The Guidance icon.	38
The Mapping icon	38
The Auto steer icon	38
Reading lightbar patterns.	39
Using the EZ-Remote joystick	40
On-screen icons	41

4	Vehicle	45
	Introduction	46
	The EZ-Steer assisted steering system	47
	Setup.	47
	Calibration	49
	Operation.	52
	The Autopilot automated steering system	55
	Setup.	55
	Operation.	55
5	Implement Application Controller	57
	Introduction	58
	Prescriptions.	59
	Field-IQ	61
	Definitions	61
	Units of measure	62
	Installing the Field-IQ hardware	63
	Setting up the Field-IQ system	63
	Advanced.	66
	Operation.	68
	HARDI 5500	71
	Setup.	71
	Advanced.	71
	Operation.	73
	Raven.	75
	Setup.	75
	Advanced.	76
	Operation.	77
	Rawson	78
	Setup.	78
	Advanced.	79
	Operation.	81
	Amazone	82
	Setup.	82
	Advanced.	82
	Operation.	84
	LH 5000	85
	Setup.	85
	Advanced.	85
	Operation.	87
	Checking the implement connection	88
6	Mapping and Guidance	89
	Introduction	90
	Configuring the Guidance settings	90
	Turn Settings	91

Coverage Settings. 92

Nudge Settings 92

Mapping 92

FreeForm Recording 93

Headland/Infill Switching 93

Boundary setup 94

Starting Guidance. 94

 Implement Setup options. 95

 Using guidance on curved segments. 96

 Using guidance on straight segments 96

 Creating straight sections on Headland or Curve swaths. 96

Fields. 96

 Creating a new field 97

 Selecting (loading) a field. 97

 Adding an AB line to a current field 97

 Selecting (loading) an AB line into a field. 97

 Record keeping 98

Resetting guidance 98

Guidance lines. 98

 Distance between guidance lines. 99

 Headlands 99

 On screen appearance. 99

Guidance Patterns 99

 Straight AB. 100

 A+ 100

 Identical curve 101

 Adaptive curve 101

 Pivot. 102

 Headland 103

 FreeForm 105

Coverage logging 106

The pause / resume function. 106

Curve smoothing 107

7 GPS. 109

Introduction 110

GPS Setup. 110

Position Quality 110

Advanced 111

 Antenna Type 111

 Use SBAS satellites in the position fix 111

 Force GPS Iono 112

 OnPath Filter 112

 Satellite Health 112

Status 112

 GPS Status 112

	Satellite Status113
	DGPS Status113
	Filter Status113
8	Data	115
	Introduction116
	Connected Farm Setup116
	Initial setup116
	Device name117
	Modem only setup117
	Network registration118
	Manage Data118
	USB118
	Clearing the internal memory119
9	System.	121
	Introduction122
	Display122
	Units122
	Color Scheme123
	Time Zone123
	View123
	Status Popup Transparency123
	Backlight124
	Touchscreen speaker volume124
	Lightbar Setup124
	Advanced125
	Save/Load Configurations125
	Radar Output125
	Enable Advanced User Config125
	NMEA Output126
	EZ-Remote126
	EZ-Remote Keypad Assignment Wizard127
	EZ-Remote LED Brightness127
	EZ-Remote Keypad Assignments127
	Unlock / Upgrade128
	Upgrading your display128
	Unlocking features128
	Status128
	FM-750129
	Recalibrate Touchscreen129

Introduction

This manual describes how to install, configure, and use the FM-750™ display, version 1.00.

Even if you have used other Global Positioning System (GPS) products before, CNH recommends that you spend some time reading this manual to learn about the special features of this product. If you are not familiar with GPS, visit the Trimble website (www.trimble.com) for an interactive look at Trimble and GPS.

About the product

The FM-750 is an in-cab touchscreen display that provides affordable guidance, steering and precision agriculture functionality.

The FM-750 display includes a built-in GPS receiver that you can upgrade to receive GLONASS satellite signals. The display can also use an array of components to maximize efficiency when planting, spraying, spreading and strip tilling, including the Trimble® Field-IQ™ crop input control system.

Related information

Sources of related information include the following:

- Release notes – The release notes describe new features of the product, information not included in the manuals, and any changes to the manuals. The release notes are available at www.trimble.com.
- Trimble training courses – Consider a training course to help you use your GPS system to its fullest potential. For more information, go to the Trimble website at www.trimble.com/training.html.

Technical assistance

Contact your local reseller for technical assistance.

Installing the Display and Antenna

In this chapter:

- [System components](#)
- [Installing the display](#)
- [Connecting the display](#)
- [Installing the antenna](#)

This chapter introduces the FM-750 display and system components, and also describes how to install the display and antenna.

System components



Item	Description	Part number
①	FM-750 display	94110-70
②	RAM mount and screws	61958
③	Quick reference card	78838-70-ENG
④	Compact disc	78821-70
⑤	GPS antenna cable	50449
⑥	Power bus/CAN cable	77282
⑦	Power cable	67258
⑧	AG25 Antenna	77038
⑨	AG25 Antenna mount plate	62034

Installing the display

Mount the FM-750 display in the vehicle cab. When you position the display, make sure that:

- it is within the driver's reach; the USB drive is easy to remove and replace.
- the touchscreen is easy to see but the display does not block the driver's view.
- it does not interfere with the driver getting in or out of the cab, or any other activities.

The image to the right shows the mounting assembly for the display:

Item	Description
❶	Diamond-shaped mounting plate
❷	RAM mount
❸	Bar mount

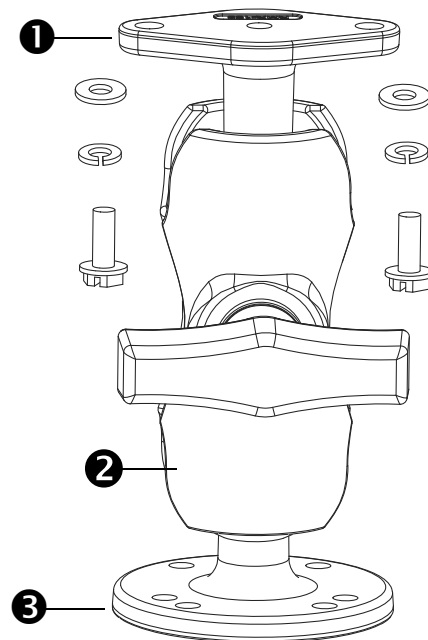

To install the display:

1. Use the supplied screws to firmly attach the diamond-shaped mounting plate to the back of the display:



2. Attach the RAM mount to the ball on the diamond-shaped mounting plate:



3. Select a position in the cab for the display. Hold the display in the selected location and check that it is easily accessible from the driver's seat.
4. Use the provided bolts to attach the bar mount to the cab.
5. Attach the other end of the RAM mount to the ball on the bar mount and then tighten the screw.

Connecting the display

The diagrams in this section show how to setup the FM-750 display as a standalone system.

To learn how to connect the FM-750 display to other the system components, see the *FM-750 Cabling Guide*.

Standalone FM-750 / WAAS / EGNOS / OmniSTAR XP/HP corrections

Connecting the FM-750 display to use WAAS or XP/HP corrections:

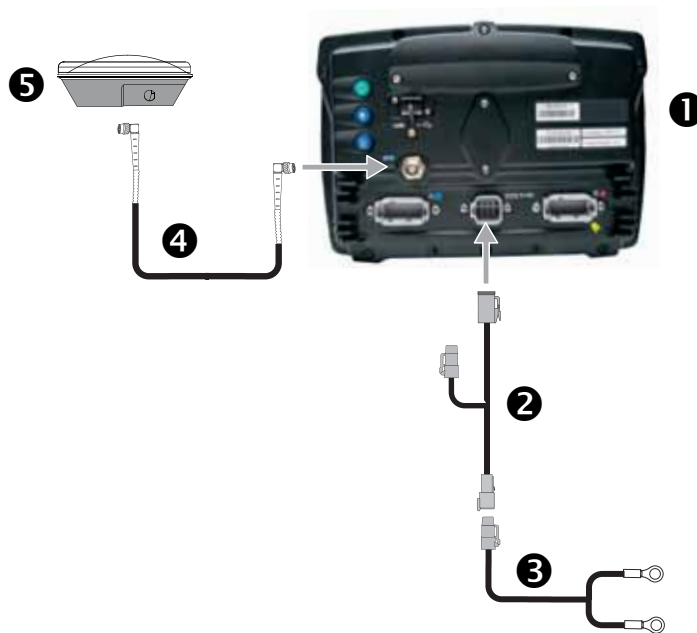

Item	Description	Trimble part number
❶	FM-750 display	94100-01
❷	FM-750 power cable	77282
❸	FM-750 basic power cable	67258
❹	8 m GPS TNC/TNC RT angle cable	50449
❺	Ag25 GNSS antenna	77038-00

Standalone FM-750 / RTK corrections

Connecting a standalone FM-750 display to use RTK corrections:

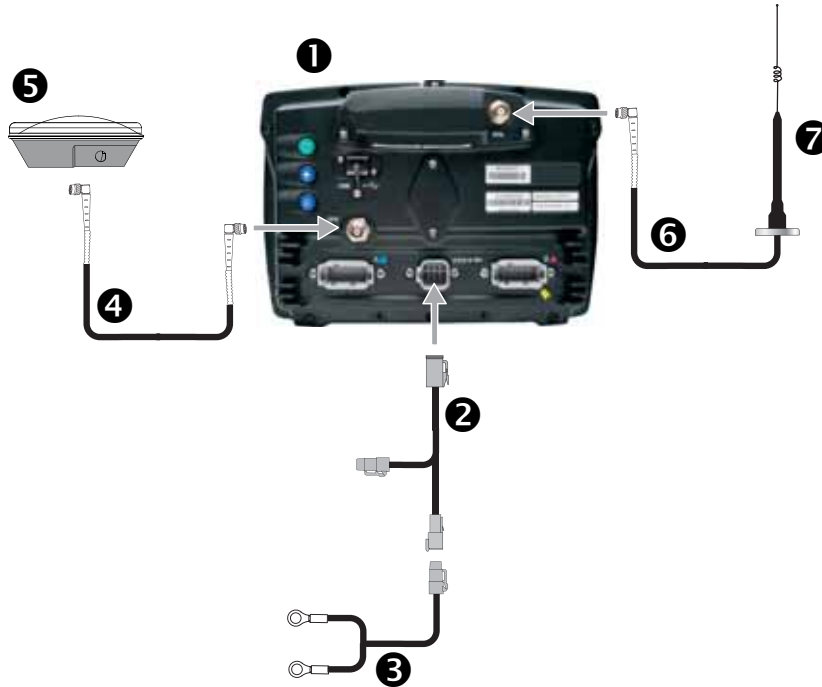

Item	Description	Trimble part number
1	FM-750 display Note – RTK password required.	94100-01
2	FM-750 power cable	77282
3	FM-750 basic power cable	67258
4	8 m GPS TNC/TNC RT angle cable	50449
5	Ag25 GNSS antenna	77038-00
6	NMO to TNC 20ft antenna cable and base	62120
7	900 MHz radio antenna kit	22882-10

Installing the antenna

Note – To minimize any interference to the GPS signal, make sure that the GPS antenna is at least 1 m (3 ft) from any other antenna (including a radio antenna). You may experience interference if you operate the vehicle within 100 m (300 ft) of any power line, radar dish, or cell phone tower.

Note – The AG25 antenna has integrated magnets for easy installation. To attach the antenna to a non-metal surface, you must use the mounting plate.

To install the AG25 antenna:

1. Find the mounting location for the antenna at the front of the vehicle roof, centered from left to right.
2. On the mounting plate, remove the protective covers from the adhesive strips.
3. Attach the mounting plate to the vehicle roof with the adhesive strips. Ensure that the mounting plate is centered along the vehicle roof.
4. Connect the antenna cable to the antenna.
5. Place the antenna directly on the mounting plate. The three magnets embedded in the bottom of the antenna will hold it in place.
6. Route the other end of the antenna cable into the cab.

Getting Started

- [Display basics](#)
- [The Quick Start Wizard](#)
- [Using the setup wizards](#)
- [The guidance screen](#)
- [Using the EZ-Remote joystick](#)
- [Reading lightbar patterns](#)
- [On-screen icons](#)

This chapter describes, in general terms, how to use the FM-750 display.

Display basics

The FM-750 display provides guidance, steering and precision agriculture functionality. The display has a touchscreen that you use to operate your system, and view guidance information. In addition, there is a USB port on the display for loading and saving field data. See [Figure 3.1](#) below, and [Figure 3.2, page 25](#).



Item	Description	Notes
1	8" Touch-sensitive screen	To interact with the system, tap the screen with your finger. For more information, see Recalibrate Touchscreen, page 129 .
2	Speaker	You can adjust the speaker volume, or turn it off. For more information, see Touchscreen speaker volume, page 124 .
3	Integrated lightbar with 27 LEDs	When lit, the LEDs show the position of your vehicle relative to your intended guidance line. For more information, see Reading lightbar patterns, page 39 .

Figure 3.1 The front of the FM-750 display



CAUTION – Do not press on the screen with a sharp item, such as a pencil or screwdriver; you may damage the surface of the screen.



Item	Description	Notes
❶	Power button	Turns the display on or off.
❷ and ❸	Brightness controls Note – You can also use the <i>Color Scheme</i> and <i>Backlight</i> menu options to set the screen brightness. See Color Scheme, page 123 , and Backlight, page 124 .	<ul style="list-style-type: none"> To increase the brightness of the screen, press ❷. To decrease the brightness, press ❸.
❹	USB socket	You can connect a USB memory stick to the display to transfer data to and from the unit. For more information, see The USB socket, page 28 .
❺	GPS connector	Connects the GPS cable (P/N 50449) to the display.
❻	Port A	Connects external devices to the display.
❼	Power connection socket	Connects the power cable (P/N 67258) to the display.
❽	Port B	Connects external devices to the display.
❾	Radio access panel	If you purchase the optional RTK module, install the module here. For more information, see the install instructions supplied with the radio module.

Figure 3.2 The back of the FM-750 display

Cleaning the touchscreen

To clean the FM-750 display use the following supplies:

- Ammonia-free glass cleaner

Note – *Do not apply glass cleaner directly to the touchscreen.*

- Soft, lint-free cotton cloth
 - 50% isopropyl alcohol
1. Apply a small amount of glass cleaner to the cloth and gently rub it against the touchscreen.
 2. To clean off any stains or smudges, use a cotton cloth dampened with 50% isopropyl alcohol.



Tip – Clean the display while it is switched off. It is easier to see dirt and fingerprints when the touchscreen is dark.

Power up

To turn on the display, press the power button on the rear of the display. After a short time, the *Welcome* screen appears:



The first time that you turn on the FM-750 display, the following wizards appear:

- Touchscreen calibration:

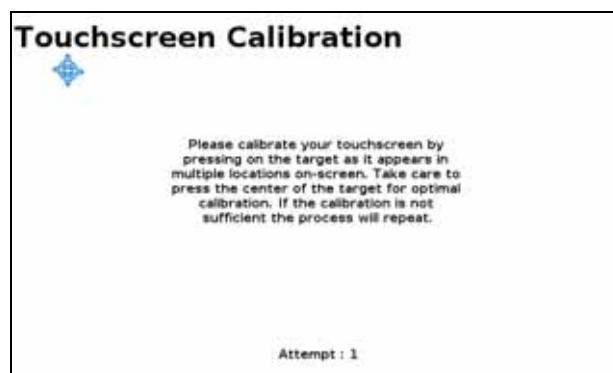

You must calibrate the touchscreen before you can use the display; to do this, follow the onscreen instructions.

- The Quick Start wizard. To configure your system properly, make sure that you run the entire wizard. See [The Quick Start Wizard, page 30](#).

Power down

To turn off the FM-750 display, hold down the power button for three seconds. While holding down the power button, the *Power Down In Progress* screen appears:



Note – To cancel the power down process, release the power button before the three second countdown is complete.

Resetting the display

Occasionally, you may want to reset the display settings. There are two ways to do this:

- **Soft reset.** This returns all settings to the factory defaults. All saved field data remains intact.
- **Hard reset:** This returns all settings to the factory defaults, *and* deletes all saved data including any field data.

Note – Do not perform a hard reset unless it is absolutely necessary or you are instructed to do so by technical support.

Soft reset

1. Power down the display and then power it on.
2. Wait until the status bar at the bottom of the second startup screen is over half full:



3. Press the power button and *top* brightness control button at the same time:



4. Hold the buttons down until the display beeps.

Hard reset

1. Power down the display and then power it on.
2. Wait until the status bar at the bottom of the second startup screen is over half full:



3. Press the power button and *both* brightness control buttons at the same time:



4. Hold the buttons down until the display beeps.

The USB socket

The USB socket is on the rear of the display. See [Figure 3.2, page 25](#).

Use the USB socket to manage your data via a USB drive.

USB drive compatibility

You can use the following USB drives with the FM-750 display:

- A-Data micro SDHC/SD/USB adapter
- Digital Concepts USB to PC Reader
- Kingston Data Traveler 8 GB
- Lexar Firefly 1 GB
- Lexar Secure II Plus
- PNY Micro Swivel Attache 4GB
- ADATA Classic C801 8GB
- Generic USB - uDHC adapter with Transcend 8GB microSDHC card
- Kingston Data Traveler 101
- Lexar JumpDrive TwistTurn
- PNY Attache
- PNY Mini Attache 4 GB

- PNY Mini Attache 8 GB
- SanDisk Cruzer
- SanDisk Cruzer Gator 4GB
- SanDisk Cruzer Micro 1GB
- Toshiba TransMemory U2M-004GTA 4GB
- Transcend JetFlash

Inserting a USB drive

1. Rotate the display so you that can see the back of it.
2. Insert the USB drive into the USB socket.

When the USB drive is properly inserted, the USB icon appears on the guidance screen:



The color of the USB icon indicates the current state of the USB drive:

- Green: the USB drive is connected.
- Yellow: the USB drive is connecting.
- Red: the connection to the USB drive has been lost.

Removing a USB drive

1. Rotate the display so that you can see the back of it.
2. Pull the USB drive out of the USB socket.



CAUTION – Do not remove the USB drive from the socket while the display is writing to or from the drive. This will corrupt the data.

Taking a screenshot

Occasionally, you may want to save a screenshot of the touchscreen, for example to provide information for troubleshooting purposes. When you take a screenshot, the display saves a .png file to the root directory of the USB drive.

Note that screenshot capability is only available when there is a USB drive inserted in the display.

To take a screenshot:

1. Press **both** brightness control buttons at the same time:



2. Hold the buttons down until the touchscreen flashes.





CAUTION – Do not remove the USB drive from the socket while the display is writing to or from the drive. This will corrupt the data.

The Quick Start Wizard

The Quick Start Wizard enables you to configure important settings before you begin driving. The first time that you turn on the display, the wizard starts automatically. Make sure that when you first turn on the display that you run the entire wizard.

When you run the wizard, you can choose whether or not it appears every time the display is turned on. If you choose to hide the wizard, when you next power up the display, the guidance screen automatically appears. However, you can still access the wizard at a later time, as follows:



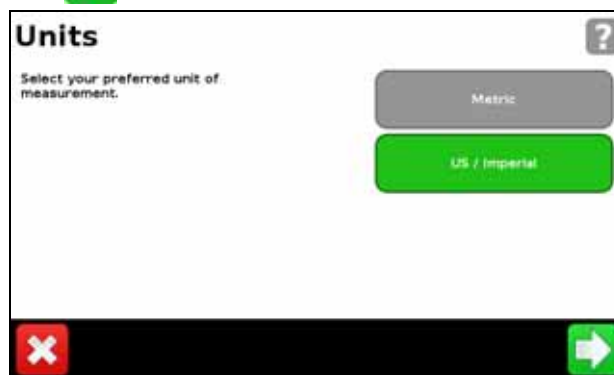





1. Tap  and then tap .
2. Tap **Quick Start Wizard**. The *Welcome* screen appears.
3. Tap . The first page of the Quick Start Wizard appears:



4. To set up your system, complete each page of the wizard. See the section below.

Using the setup wizards

The FM-750 display contains various wizards that guide you through the task of configuring your system. The following table describes how to use the wizards to enter your system settings.

To ...	Tap ...
Select the setting you require	The field that displays the desired value. When you make your selection, the field changes color from gray to green.
Enter the numbers that you require	
Enter text	
Accept the selection and go to the next screen	
Accept the selection and exit the screen	
Navigate the wizard	
Go back to the previous page	
Exit the wizard Note – When you exit the wizard, the system retains any settings you have already selected; for any settings that you have not yet entered, the system uses the settings from the previous configuration.	
Access the on-screen help	

The guidance screen



The guidance screen displays a mix of text and icons that provide operating information and access to various system functions. The availability of the text and icons depends on the set up of your system. For example, some icons are not available while you are using an auto steer system.

To activate an icon, tap it with your finger. If the display does not respond when you tap it, see [Recalibrate Touchscreen](#), page 129.

The following sections describe the icons that can appear on the guidance screen.

Status

Tapping  scrolls through several pop-up screens that describe various system settings:



To remove the pop-ups, continue to tap  until they disappear.

Settings

Tap  to open the *Settings* screen:



Use the *Settings* screen to adjust your system settings, and view the status of the following:

Setting	For more information, see ...
Vehicle	Chapter 4, Vehicle, page 45
Implement	Chapter 5, Implement Application Controller, page 57
Guidance	Chapter 6, Mapping and Guidance, page 89
GPS	Chapter 7, GPS, page 109
Data	Chapter 8, Data, page 115
System	Chapter 9, System, page 121

View



The options for viewing the guidance screen are:

- Zoom In
- Zoom Out
- Change View

Note – *Change View toggles between the Overhead view and Trailing view icons.*



- Panning Mode

To:

- **change** the view, tap , and then select the option that you require.
- **exit** a view and return to the guidance screen, tap .

To learn how to change the View settings, see [View, page 123](#).

Zooming

To zoom in or out on the guidance screen, tap either  or .

Viewing modes

There are two viewing modes, Overhead and Trailing.

By default, the view switches from Overhead to Trailing when you approach the AB line.

- To access the Overhead view, tap  .



- To access the Trailing view, tap  .

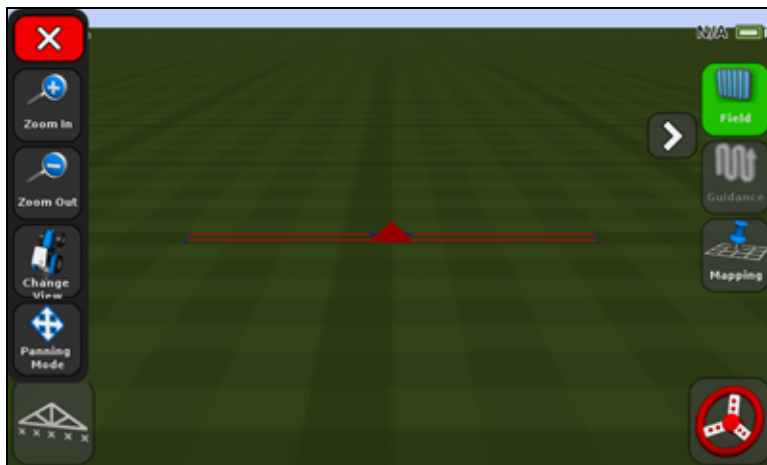

Extended icons

The guidance screen features several extended icons that are hidden in the default view.

To access or hide the extended icons, tap  or  .

The following images show how the extended icons appear on the guidance screen when they are expanded and collapsed:



Expanded



Collapsed

Quick Access icon

You can use the Quick Access icon to quickly adjust common settings.

The items that appear in the Quick Access menu will vary depending on the applications that you are currently running.

The following sections describe the items that may appear.

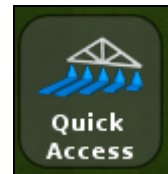

Note – The Quick Access icon only appears when you are running Field-IQ or a variable rate controller.

Boom setup

Use this option to view and adjust the following settings:

Value ...	Notes ...
Implement width	Enter the width of the current implement. The display uses this value to automatically calculate the swath spacing. Enter a width between 1' 00" - 328' 01" (0.30 - 99.99 m).
Boundaries	See Boundary setup, page 94 .
Number of sections	Enter the number of sections you want to control on the implement. Enter a number between 1 - 10.

Refill

Use this option to view and adjust the following settings:

Setting ...	Notes ...
Current volume	Set the current volume of the tank or bin.
Refill method	Choose from one of the following options: <ul style="list-style-type: none"> • Refill: to fill the tank or bin to the top • Partial Refill: to add a specified amount to the tank or bin when you select Partial Refill Now from the <i>Refill</i> screen.
Refill Now / Partial Refill Now	Use this option to refill the tank or bin.

Section Switching Setup

Use this option to view and adjust the following settings:

Setting ...	Notes ...
Coverage switching overlap	Control the amount of boom switching overlap allowed before the system switches that section. Enter a percentage between 1-99%. For: <ul style="list-style-type: none"> • Less skip: Set a high percentage when total coverage is essential. The system will turn off sections when they cover a larger percentage of any fully covered areas. This may cause some double-coverage. Sections will turn on as soon as they move from a covered to an uncovered area. • Less overlap: Set a low percentage when you need to save product. The system will turn off sections as soon as you reach any covered area. This may leave some skips. Sections will turn on when the entire section has moved from a covered to an uncovered area.
Refill method	Choose from one of the following options: <ul style="list-style-type: none"> • Refill: to fill the tank or bin to the top • Partial Refill: to add a specified amount to the tank or bin when you select Partial Refill Now from the <i>Refill</i> screen.
Refill Now / Partial Refill Now	Use this option to refill the tank or bin.

Boundary switching overlap

Use this option to control the amount of overlap on a boundary before the system switches off the boom section. Enter a percentage between 1-99%.

Note – This setting only operates when the boom is overlapping a headland, or pivot boundary, or exclusion zone.

For:

- **Less skip**: Set a high percentage when it is acceptable to apply outside the boundary.
- **Less overlap**: Set a low percentage when you do not want to apply outside the boundary. A very low setting may cause some skip at the boundary.

On/off valve latency

This option allows for hardware delays by adjusting the amount of time needed before turning the valves on or off.

To use this option:

1. Measure the amount of time it takes (in seconds) for the system to reach the correct rate after you have switched it on or off.
2. Enter a time between 0.0 - 10.0 seconds.

Intentional overlap

You can use this option to make sure that when applying, there are no gaps in coverage if you move into an uncovered area or out of a covered area.

Use this option ...	To set the distance that you want to travel before...
On overlap distance	Exiting a covered area and switching the implement on
Off overlap distance	Entering a covered area and switching the implement off

Target rate

Use this option to set the target application rate (the amount of product you want to apply). Enter a number between 1333 - 41333.

Valve aggressiveness

If you use an auto steer system, such as an EZ-Steer or Autopilot system, you can use this option to adjust how the system responds to steering changes.

Note the following:

- A higher setting brings the vehicle back on line quickly, but may cause tight oscillations.
- A lower setting gives a more moderate response to bringing the vehicle back on line, but can avoid overshoot.

Enter a setting between 50 - 150%.

The Field icon

From the guidance screen, tap  to create a new field or select an existing field. See [Chapter 6, Mapping and Guidance](#).

The Guidance icon

From the guidance screen, tap  to quickly nudge, shift or resume a guidance line:

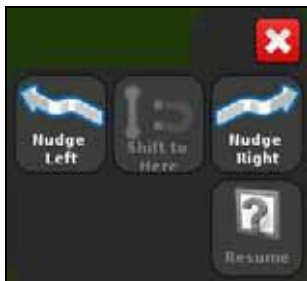

The Mapping icon

From the guidance screen, tap  to quickly add or delete the following features:

- rock
- line
- tree
- area
- weed
- exclusion



The Auto steer icon

From the guidance screen, tap  to quickly adjust the aggressiveness setting for the EZ-Steer or Autopilot system:



Reading lightbar patterns



When lit, the LEDs show the position of your vehicle relative to your intended guidance line. As your vehicle position changes in relation to the guidance line, the LEDs move left or right.

Use the lightbar to obtain accurate guidance when:

- you have set an implement offset or implement draft
- fine-tuning guidance on straight swaths

The LEDs in the integrated lightbar show the position of your vehicle relative to the guidance line:

- When your vehicle is on the guidance line, the three central green LEDs are lit.
- As your vehicle moves off the guidance line, the lit LEDs move left or right, and change to red. Note that the LED pattern that appears has a different meaning for each Main Lightbar LED Mode. For more information, see the table below, and [Lightbar Setup, page 124](#).

This LED pattern ...	Indicates that the vehicle is ...
	Directly on the guidance line.
	Off the guidance line. For this pattern, if the Main Lightbar LED Mode is set to: <ul style="list-style-type: none"> • Chase, the vehicle is offline to the left. • Pull, the vehicle is offline to the right.
	Off the guidance line. For this pattern, if the Main Lightbar LED Mode is set to: <ul style="list-style-type: none"> • Chase, the vehicle is offline to the right. • Pull, the vehicle is offline to the left.

Using the EZ-Remote joystick

Optionally, you can use an EZ-Remote joystick to control the FM-750 display. The joystick has ten LED buttons: six have preset functions; you can assign one of the following functions to each of the other four:

- Map a rock, tree or weed
- Start or finish a line
- Start or finish an area
- Start or finish an exclusion zone
- Turn coverage on or off
- Camera A or Camera B control
- Show trailing map view
- Show overhead map view
- Zoom
- Show status

To learn how to assign a function to a programmable button, see [EZ-Remote, page 126](#).

The diagram and table below explain how to use the EZ-Remote joystick.



Use this button ...	To ...
Engage	Engage auto steering
Up / Down	Change the numbers in the <i>Setup</i> screens.
Right	Nudge the guidance line to the right , in the guidance screen.
Left	Nudge the guidance line to the left , in the guidance screen.

Use this button ...	To ...
Trigger	N/A
1-4	Activate the function that you have assigned. To learn how to assign a function to the programmable button, see the EZ-Remote, page 126 .









On-screen icons



The tables in this section describe all of the icons available on the FM-750 display.

Note – Icons appear only when they are appropriate. They are not visible at all times.



To activate an icon, tap it with your finger. If the display does not respond when you tap it, see [Recalibrate Touchscreen, page 129](#).



System icons

Icon	Description
	System and display setup
	Autopilot setup
	GPS/GLONASS setup
	Data configuration
	Help
	Settings / Configuration
	Next page
	Back page





Icon	Description
	Menu
	Configure
	Status
	Setup wizard
	Edit item
	Delete
	Cancel changes
	Accept / save changes



Information icons

Icon	Description
	Setup complete
	Critical warning



Icon	Description
	General alert
	Information



View icons

Icon	Description
	Activate external video input
	Full screen external video
	Run screen trailing view
	Run screen overhead view





Icon	Description
	Pan view
	Zoom in
	Zoom out



Application icons





Icon	Description
	Manual section control
	Automatic section control
	Target rate



Icon	Description
	Section control off
	Coverage logging on
	Coverage logging off

Guidance icons



Icon	Description
	Guidance pattern select
	Pause guidance
	Nudge left
	Nudge right
	Record FreeForm guidance pattern



Icon	Description
	Start recording headland
	Pause recording headland
	End headland recording
	Cannot engage auto guidance
	Ready to engage auto guidance

Icon	Description
	Set A point
	Set B point
	Shift AB line
	Next AB line

Icon	Description
	Auto guidance engaged
	Increase auto guidance aggressiveness
	Decrease auto guidance aggressiveness

Mapping icons

Icon	Description
	Map line feature
	Map tree (point feature)
	Map rock (point feature)

Icon	Description
	Mapping configuration
	Area feature

Vehicle

In this chapter:

- [Introduction](#)
- [The EZ-Steer assisted steering system](#)
- [The Autopilot automated steering system](#)

This chapter describes how to configure your auto steer system for use with the FM-750 display.

Introduction

To ensure the proper performance of your auto steer system, you need to calibrate it correctly. Before you calibrate your auto steer option, do the following:

- Ensure that the vehicle's hydraulic oil is up to operating temperature. Refer to the vehicle documentation.
- Ensure that the tire pressure is correct.
- Complete the GPS Setup on the FM-750 display. For more information, see [Chapter 7, GPS](#).

When you calibrate your auto steer option, pay attention to the following:

- Choose a field with the smoothest possible surface and perform the calibration at the normal operating speed for the vehicle.
- For a high-clearance sprayer, perform the initial calibration without an implement or with the booms folded in. After the initial calibration is completed, you can fine tune the settings with the implement or booms folded out.

The calibration process requires a straight AB line. If you do not create an AB line before you begin the calibration, the system prompts you to open a field and create one.

To access the auto steer options:

1. In the guidance screen, tap  and then tap **Vehicle**.
2. Tap **Auto Steer**:



The EZ-Steer assisted steering system

The EZ-Steer® assisted steering system works with the FM-750 display's internal GPS receiver to provide vehicle guidance. As such, you must complete the GPS setup before you calibrate, set up or run your EZ-Steer system. See [Chapter 7, GPS](#).

Setup

To view and adjust the settings for the EZ-Steer system:

1. In the guidance screen, tap  and then tap **Vehicle**.
2. Tap **Auto Steer** and then **EZ-Steer Setup**:



Note – If the *EZ-Steer Setup* button does not appear, tap *Auto Steer System Type* and then select *EZ-Steer* for your controller.

The EZ-Steer Setup screen contains the following options:

- Engage Options
- Vehicle Setup
- Aggressiveness
- EZ-Steer Demo
- EZ-Steer Calibration Wizard

The following sections describe each option.

Engage Options

Use this option to view and adjust the settings described below:

Setting ...	Notes ...
Minimum/Maximum speed	Enter the minimum and maximum speeds at which the EZ-Steer system will disengage: <ul style="list-style-type: none"> • Minimum: between 1.0 and 15.9 mph (1.6 and 25.5 kph). • Maximum: between 1.0 and 18.0 mph (1.6 and 28.8 kph).
Maximum Angle	The EZ-Steer system will not engage when the vehicle is heading toward the guidance line at an angle greater than the Maximum Angle. Enter an angle between 5 and 45 degrees.
Engage/Disengage Offline	Engage offline: The system will not engage when the vehicle is offline further than the Engage Offline distance. Enter a distance between 0' 5" and 27' 0" (0.2 and 8.2 m). Disengage offline: The system will automatically disengage when the vehicle is offline further than the Disengage Offline distance. Enter a distance between 0' 6" and 27' 00" (0.2 m and 8.2 m).
Override sensitivity	Control how much force is required to disengage the system. Enter an increment between 1-100%.
EZ-Steer external switch	Enable or disable additional safety features.
EZ-Steer operator timeout	Enter a time between 1-60 minutes.

Vehicle Setup

Use this option to view and adjust the settings described below:

Setting ...	Notes ...
Vehicle type	Enter the type of vehicle on which the EZ-Steer system will be installed.
Wheelbase	See Entering vehicle measurements, page 50 .
Antenna height	See Entering vehicle measurements, page 50 .
Antenna to axle offset	See Entering vehicle measurements, page 50 .
Angle per turn	Adjust the angle that the wheels turn during one full rotation of the steering wheel. Enter an angle between 2-149 degrees.
Freeplay left/right	Adjust this setting if the vehicle is consistently off to the right or left of the guidance line. Enter a measurement of 0-12" (0-30.48 cm).
Motor speed	Control the speed of the EZ-Steer drive wheel motor.
Motor direction is reversed	Select yes or no.

Setting ...	Notes ...
Sprayer steering delay	Account for time lags with vehicle steering. Enter a value between 0.1-1.5.
Swather steering delay	Account for time lags with vehicle steering. Enter a value between 0.1-1.5.

Aggressiveness

Use this option to view and adjust the settings described below:

Setting ...	Notes ...
Online aggressiveness	Control how aggressively the EZ-Steer system corrects deviations from the guidance line. Enter a value between 50-150%.
Approach aggressiveness	Control how fast the EZ-Steer system steers the vehicle onto the guidance line. Enter a value between 50-150%

EZ-Steer Demo

Use this option to access the EZ-Steer Demo Mode.

EZ-Steer Demo Mode is useful for practice with defining fields, coverage logging, and assisted steering. EZ-Steer Demo Mode requires an EZ-Steer controller, motor, and EZ-Steer simulator stand (P/N 54836-00).

EZ-Steer Calibration Wizard

The EZ-Steer Calibration Wizard guides you through the process of calibrating your EZ-Steer system.

Calibration

Before you begin to use the display you must calibrate the EZ-Steer system. To do this, complete the Quick Start Wizard (see [The Quick Start Wizard, page 30](#)) that appears the first time that you use the display.

To calibrate the EZ-Steer system at a later time, complete the following process:

1. In the guidance screen, tap  and then tap **Vehicle**.
2. Tap **Auto Steer** and then **EZ-Steer Setup**:



Note – If the EZ-Steer Setup button does not appear, tap Auto Steer System Type and then select EZ-Steer for your controller.

3. In the EZ-Steer Setup screen, tap **EZ-Steer Calibration Wizard**.

The wizard guides you through the following processes:

- Entering your vehicle measurements
- T2 roll calibration
- EZ-Steer calibration

Note – To complete the above processes, you must have GPS connected.

Entering vehicle measurements

For optimum guidance, you must take accurate vehicle measurements and enter them into the display.

Note – Do not enter calibration numbers from EZ-Guide Plus or EZ-Steer T2 systems. This may cause very poor vehicle control, including swerves and/or large oscillations.



To streamline the calibration process, you may want to take the vehicle measurements and record them for entry later on.

The techniques for taking vehicle measurements are described below; to learn about implement measurements, see [Implement Setup options, page 95](#).

Before you take the measurements, position your vehicle as follows:

1. Park the vehicle on level ground.
2. Make sure that the vehicle is straight, with the centerline of the body parallel to the wheels.

3. Take the vehicle measurements:

To take this measurement ...	Measure from the ...	
Wheelbase	Center (the axle) of the front wheel to the center of the back wheel. Note that the wheelbase measurement for: <ul style="list-style-type: none"> • Tracked vehicles, is exactly half of the length of the track • Articulated 4WD vehicles, is half of the distance between the center of the front and rear wheels. 	
Antenna height	Ground to the top of the GPS antenna.	
Antenna to axle offset	Center (the axle) of the front or rear wheel to the top of the GPS antenna. Note – Make sure that you take this measurement to within 7.6 cm (3 in.) as an incorrect distance may result in poor steering performance. Take the measurement from the antenna to the correct point of your vehicle, as follows: <ul style="list-style-type: none"> • Rear axle: <ul style="list-style-type: none"> - MFWD - Sprayer - Floater - Truck • Front axle: <ul style="list-style-type: none"> - 4wd tractor - Combine • Track center: <ul style="list-style-type: none"> - Tracked tractor If the antenna is: <ul style="list-style-type: none"> • in front of the axle, enter a Forward distance • behind the axle, enter a Behind distance 	



T2 roll calibration

Calibrating the T2 roll sensor enables the display to calibrate terrain compensation in the EZ-Steer controller. This step requires you to:

- Enter an accurate value for controller orientation.
- Park the vehicle and mark the inside of both sets of wheels.
- Remain stationary while the system calculates the roll offset. This takes approximately 20 seconds.
- Turn the vehicle around and ensure the wheels are over the positions marked in the previous step.
- Remain stationary while the system calculates the roll offset. This takes approximately 20 seconds.

EZ-Steer calibration

In this step you must drive and engage on a straight AB line in a clear field:

1. Begin driving and tap  .
2. Drive 160 feet and then tap  .

A series of calibration screens will allow you to adjust any settings as necessary.

Operation

You must calibrate and set up the EZ-Steer system before operation.

Engaging the system

Before you can engage the EZ-Steer system, you must:

- open a field in the guidance screen
- define an AB line
- position the vehicle within the configured engage limits

To engage the system:

1. Point the nose of the vehicle toward the guidance line and drive at operational speed.
2. Do one of the following:
 - From the guidance screen, tap  .
 - Press the optional remote engage foot pedal.



Disengaging the system

The EZ-Steer system automatically disengages when one of the following happens:

- The vehicle is outside the configured engage limits.
- You pause the system.
- GPS positions are lost.
- You tap the **Engage** button on the guidance screen.

You can manually disengage the EZ-Steer system by turning the steering wheel (this overrides the electric motor). Check this setting before you start using the system by engaging on a line and then turning the wheel until the system disengages. To adjust the amount of force required to disengage the system, change the Override Sensitivity in the Engage Options screen.

Engage status indicators

Engage status	Icon color
Ready to engage	
Engaged	
Cannot engage	

Curve Auto steering Accuracy in Headlands

It is possible to engage the EZ-Steer system on headlands with sharp corners at the edge of the field. However, the EZ-Steer system may be unable to drive around these sharp bends. Use one of the following methods to compensate:

- Manually steer the vehicle around the corner. Once you have rounded the corner, re-engage the EZ-Steer system.
- In the Engage Options screen, increase the Disengage Offline distance.

Vehicle-specific performance

Before you use the EZ-Steer system, consider the following performance suggestions.

Vehicle type	Performance hint
2WD tractor	<p>With tractors that have SuperSteer (for example, New Holland TG), if the tractor has a SuperSteer front axle, for best performance:</p> <ul style="list-style-type: none"> • Reduce the Online Aggressiveness value. • Line up close to the swath and make certain that the front wheels are straight before engaging the EZ-Steer system. • To get smoother performance when the vehicle is pulling an implement over tilled ground, enable the Diff-Lock. This prevents the machine from pulling sharply to the left or right. If you are calibrating on a hard surface, turn off Diff-Lock.
4WD tractor	<p>The EZ-Steer system can be installed on Case IH STX tractors with Accusteer. For optimal performance, disable Accusteer using the switch in the cab (if possible).</p>

Vehicle type	Performance hint
Sprayer	<ul style="list-style-type: none"> • It is common for these vehicles to have slow steering. To compensate for this, use high aggressiveness. • If you experience large, slow oscillations, increase the aggressiveness. • When you configure the system on a sprayer, the Sprayer steering delay setting is available on the <i>Vehicle Setup</i> screen. • Some sprayers have steering that is slow to react after you turn the steering wheel. The system uses the steering delay setting to compensate for this slowness and ensure that steering corrections occur at the correct point.
Swather	<ul style="list-style-type: none"> • When you configure the system on a swather, the Swather steering delay setting is available on the <i>Vehicle Setup</i> screen. • Some swathers have steering that is slow to react after the steering wheel is turned. The system uses the steering delay setting to compensate for this slowness and ensure that steering corrections occur at the correct point. • To improve the performance of your swather, adjust the Swather steering delay setting by a small amount (0.1 seconds) at a time. Test the result between each adjustment

After using the EZ-Steer system

- Any time that you are not using the EZ-Steer system, pivot the EZ-Steer motor away from the steering wheel.
- **Before** you leave the vehicle turn off the EZ-Steer system power switch or remove the power plug.

The Autopilot automated steering system

Note – For advanced setup options contact your local reseller.

Setup

To view and adjust settings for the Autopilot system:

1. In the guidance screen, tap  and then tap **Vehicle**.
2. Tap **Auto Steer** and then **Autopilot Configuration**:



Note – If the Autopilot Configuration button does not appear, tap Auto Steer System Type and then select Autopilot for your controller.

From the Autopilot Configuration screen you can view and adjust the settings for:

- Online Aggressiveness
- Operator Alert Timeout
- End of Row Warning Distance
- NMEA Output. See [Chapter 7, GPS](#).
- Save Vehicle Configuration File (use a virtual keypad to save your current vehicle configuration)

Operation

You must calibrate and set up the Autopilot automated steering system before operation.

Engaging the system

Before you can engage the Autopilot automated steering system, you must:

- open a field in the guidance screen
- define an AB line
- position the vehicle within the configured engage limits

To engage the system:

1. Point the nose of the vehicle toward the guidance line and drive at operational speed.
2. Do one of the following:
 - From the guidance screen, tap  .
 - Press the optional remote engage foot pedal.



Disengaging the system

The Autopilot automated steering system automatically disengages when one of the following happens:

- The vehicle is outside the configured engage limits.
- You pause the system.
- GPS positions are lost.
- You tap the **Engage** button on the guidance screen.

You can manually disengage the system by turning the steering wheel (this overrides the electric motor). Check this setting before you start using the system by engaging on a line and then turning the wheel until the system disengages. To adjust the amount of force required to disengage the system, change the Override Sensitivity in the *Engage Options* screen.

Engage status indicators

Engage status	Icon color
Ready to engage	
Engaged	
Cannot engage	

After using the Autopilot automated steering system

- Any time that you are not using the system, pivot the Autopilot automated steering system motor away from the steering wheel.
- **Before** you leave the vehicle turn off the system power switch or remove the power plug.

Implement Application Controller

In this chapter:

- [Introduction](#)
- [Field-IQ](#)
- [HARDI 5500](#)
- [Raven](#)
- [Rawson](#)
- [Amazone](#)
- [LH 5000](#)
- [Checking the implement connection](#)

This chapter describes how to configure the FM-750 display to use an implement application controller.

Introduction

The options in the *Implement* screen enable you to configure an implement application controller, such as the Field-IQ crop input control system.

To access the *Implement* screen:

1. From the guidance screen, tap .
2. From the *Settings* screen, tap **Implement**:



The *Implement* screen contains two options, *Advanced* and *Initial Setup*. The *Advanced* option only appears after you have set up your controller via the *Initial Setup* option.

To set up your controller:

1. From the *Implement* screen, Tap **Initial Setup**. The *Controller Type* screen appears.



Note – To access all of the available *Controller Type* options (apart from *None* and *Field-IQ*) you must have a VRA unlock code. To obtain a VRA unlock code, contact your local reseller.

2. Select the controller that you are using.

Note – When you change the controller type, any open field will close.

3. Configure your controller. For more information, see the following sections:
 - [Field-IQ, page 61](#)
 - [HARDI 5500, page 71](#)

- [Raven, page 75](#)
- [Rawson, page 78](#)
- [Amazone, page 82](#)
- [LH 5000, page 85](#)

Prescriptions

The FM-750 display can use a prescription file to determine the rate of application in different areas of the field.

The prescription file consists of three separate ESRI files: .shp, .dbf and .shx. Each of these files contain different attribute information that the display uses.

You must load a prescription from the USB drive to the internal memory of the FM-750 display. The display cannot read prescriptions directly from a USB drive. For more information, see the section below.

Loading a prescription

1. Copy the prescription file from your computer to the *AgGPS/Prescriptions* folder on your USB drive.

Note – If you do not have an *AgGPS* directory on your USB, create one by exporting field data to the USB. For more information, see [Sending data to the USB drive, page 119](#).

2. Insert the USB drive into the USB socket, and then copy the prescription file to the display's internal memory. See [Retrieving data from the USB drive, page 119](#).
3. From the guidance screen, tap  to create a new field or select an existing field.

The FM-750 display searches the internal memory for prescription files, and after you define or select a field, the following screen appears in the wizard:



4. Select the prescription file that you require and then tap . The following screen appears:

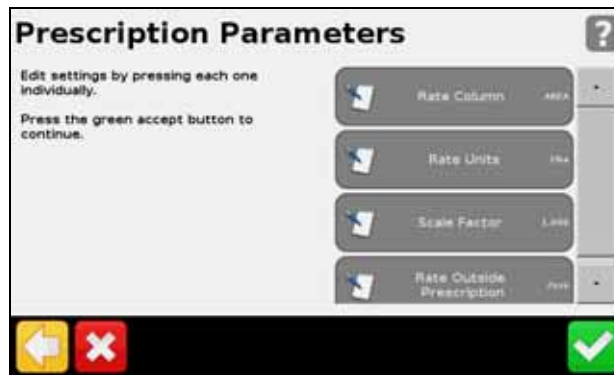

5. Configure each of the items in the *Prescription Parameters* screen.



CAUTION – For the system to work correctly, you **must** choose the correct Rate Column setting. If you do not, then the applied rate will be incorrect.

Field-IQ

The Field-IQ crop input control system enables the FM-750 display to control the following:

- planters
- sprayers
- liquid strip-till toolbars
- spinner spreaders

Additionally, it enables the display to use Tru Count air clutches or Tru Count LiquiBlock to perform automatic section control, and/or use a prescription with Rawson drives to control seed or liquid fertilizer rates.

The different functions of the Field-IQ system that you can configure and control are:

Application	Main functions
Planter	<ul style="list-style-type: none"> • Seed section control of up to 48 individual rows (Field-IQ section control module(s) needed) using Tru Count air clutches. • Seed rate control using up to 4 Rawson drives to change seed population (Field-IQ Rawson Control Module(s) needed). • Liquid fertilizer control of up to 48 individual liquid nozzles (Field-IQ section control module(s) needed) using Tru Count LiquiBlock valves. • Variety tracking.
Sprayer	<ul style="list-style-type: none"> • Liquid section control of up to 48 individual rows (Field-IQ section control module(s) needed) using existing boom shutoff valves or Tru Count LiquiBlock valves. • Connects to spraying systems that are configured with servo, pump servo, PWM, bypass, dump and master valves.
Strip-till (liquid)	<ul style="list-style-type: none"> • Liquid section control of up to 48 individual spray nozzles (Field-IQ Section Control Module(s) needed) using Tru Count LiquiBlock valves. • Liquid rate control using up to 2 Rawson drives connected to fixed displacement pumps, such as CDS-John Blue piston pumps, to change liquid rate (Field-IQ Rawson Control Module(s) needed).
Spreading	<ul style="list-style-type: none"> • Spreading rate control using a Rawson Drive (Field-IQ Rawson Control Module(s) needed).

Definitions

Term	Definition
Section	A number of rows or spray nozzles that are controlled by Tru Count air clutches or Tru Count LiquiBlock valves, or boom valves. A section can have either a single row/nozzle or multiple rows/nozzles depending on how the system is set up.
Row	The individual row unit which material comes from on the implement. This can be controlled individually as a single row section, or as a group with other rows in a multiple row section.
Master Switch Box (MSB)	Master on/off/jump start, auto/manual switch, rate selection, and increment/decrement switch. See Field-IQ master switch box, page 69

Term	Definition
12 Section Switch Box (12SSB)	Required for section control. Manually control sections/rows. See Field-IQ 12-section switch box, page 70
Section Control Module (SCM)	Controls 12 sections/rows per module with up to 4 modules (48 module sections/rows).
Rate and Section Control Module (RSCM)	Controls 12 sections and application rate for spraying, spreading and NH3.
Rawson Control Module (RWCM)	Controls 1 Rawson variable rate drive per module with up to 4 modules.
Implement Switch	Included in planter, NH3 and strip-till platform kits.

Units of measure

Type	Unit	Symbol	Description
Seed	Metric	kS/ha	Thousands of seeds per hectare
	US/Imperial	kS/a	Thousands of seeds per acre
Granular seed	Metric	kg/ha	Kilograms of seed per hectare
	US/Imperial	lbs/a	Pounds of seed per acre
Liquid application	Metric	L/ha	Liters per hectare
	US/Imperial	Gal/a	Gallons per acre
Granular fertilizer	Metric	kg/ha	Kilograms of fertilizer per hectare
	US/Imperial	lbs/a	Pounds of fertilizer per acre
NH3	Metric	kg/NH3	Kilograms of anhydrous per hectare
	US/Imperial	lbs/NH3	Pounds of anhydrous per hectare
	Metric	kg/N	Kilograms of nitrogen per hectare
	US/Imperial	lbs/N	Pounds of nitrogen per hectare



WARNING – Anhydrous ammonia (NH₃) can cause severe burning, blindness, or death. Before you begin to operate or service equipment that contains NH₃, carefully read and follow all safety instructions in [Working with anhydrous ammonia, page 6](#).



Installing the Field-IQ hardware

For information on installing the Field-IQ crop input control system on your implement, refer to:

- *Field-IQ Platform Installation Instructions*
- *Tru Count Air Clutch Installation Instructions*
- *Rawson Installation Instructions*

Setting up the Field-IQ system

The FM-750 display automatically detects the Section Control Modules and/or the Rawson Control Modules installed on your implement. When you use the wizard to set up your Field-IQ system, the screens that appear may differ according to the modules you have installed. If, during the setup, a screen appears that you are unsure of, you can either:

- Tap  to go back and check the previous screen(s).
- Tap  to discard all of the changes and start again.

To set up your Field-IQ system:

1. From the guidance screen, tap .
2. From the *Settings* screen, tap **Implement**. The *Controller Type* screen appears.
3. Select *Field-IQ*:



4. The *Field-IQ Hardware Summary Screen* appears. Press  to continue through the setup wizard.
5. In the *Application Controller Mode* screen, select what you are using the implement for:
 - Row crop planting
 - Liquid
 - Granular seed

- Granular spreading
- Anhydrous

Note – If you change the Application Controller Mode, the display erases any previous calibrations.

6. In the *Rate and Section Control* screen, select one of the following:
 - Section Control Only
 - Rate Control Only
 - Both

Note – If you do not have at least one section control box and at least one Rawson control box installed, both options will not appear.

7. In the *Implement Measurements* screen, edit each of the setting items. Note that the items that appear in this screen vary depending on the Application Controller Mode chosen previously.
8. In this part of the wizard, you must indicate the following:

For Rate Control:

- a. Where on your implement each module is located:

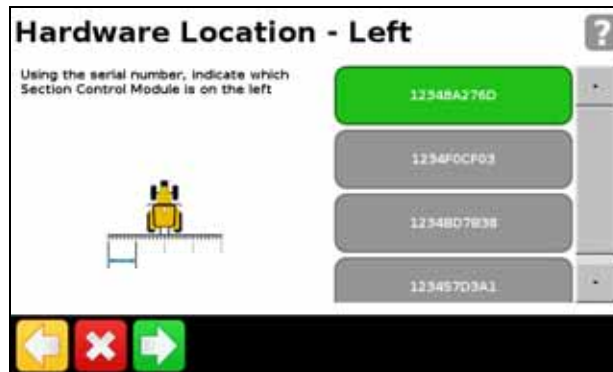

- b. For each module, the width of the section it will control:

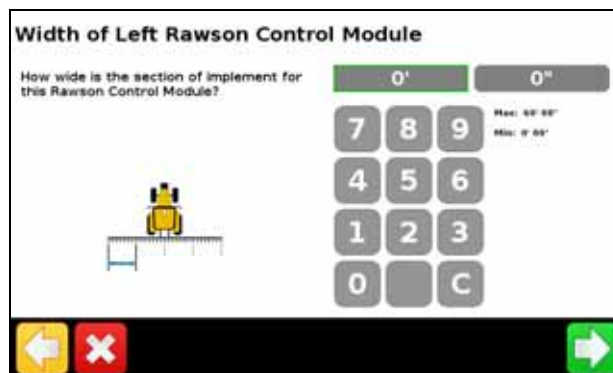

For Section Control:

- a. Where on your implement each module is located:

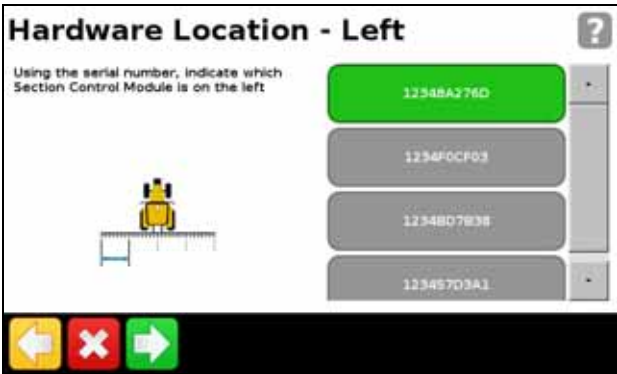

- b. For each module, the number of sections it will control:

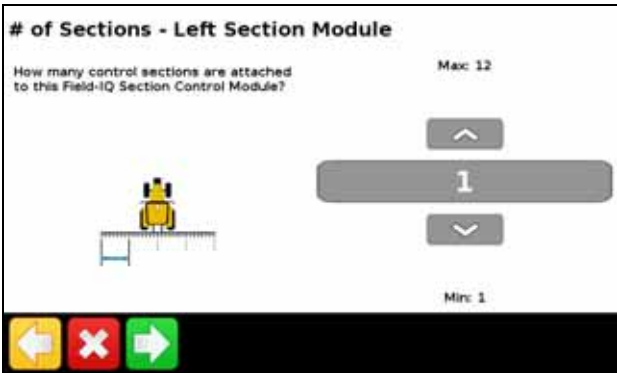

Note – You must enter accurate values for the system to work properly.

- 9. Once you have completed the wizard, you can adjust your section widths if necessary:



Field-IQ Hydraulics Test

After the setup wizard is complete, the display tests the hydraulics of your system. During this test you must run the motor(s) at the minimum and maximum RPM and make sure the motor(s) achieve these RPM.



WARNING – MOVING PARTS DURING THIS TEST! Please stay clear of the implement. Ensure the implement is raised, the transmission is in PARK and the emergency brake is applied before continuing.

Field-IQ Calibrations

After the hydraulics test is complete, the display calibrates your system. The available calibrations are:

- Field-IQ Rawson Control Module
- Servo Pump or PWM Pump
- Pressure Sensors
- Implement Lift Switch

When the calibration is complete, save the data to a configuration file and export it to the USB drive. See [Chapter 8, Data](#).

Advanced

Use the *Advanced* option in the *Implement* screen to configure the following:

- Controller and Material Type Selection
- Implement Setup
- Section Switching Setup
- Field-IQ System Status



Controller and Material Type Selection

Select this option to return to the *Controller Type* screen. For more information, see [Introduction, page 58](#).

Implement Setup

Use this option to adjust the following settings:

- Implement Measurements. If you select this option, the display returns you to the Implement Measurements screen in the Field-IQ setup wizard. See [Step 7, page 64](#).
- Section Control Module Setup. If you select this option, the display returns you to the second part of the Field-IQ setup wizard. See [Step 8, page 64](#).

Section Switching Setup

Use this option to view and adjust the following settings:

Setting ...	Notes ...
Coverage switching overlap	Control the amount of boom switching overlap allowed before the section will be switched by the system. Enter a value between 1 - 99%.
Boundary switching overlap	Control the amount of overlap on a boundary before the boom section is switched off. Enter a value between 1 - 99%.
On/Off valve latency	Tune the section switching to allow for hardware delays. Enter a time between 0.0 - 10.0 seconds.
Intentional overlap	Set a distance to be overlapped when moving to an unsprayed area or out of a sprayed area. Enter a distance between 0' 00" - 32' 10" (0.00 - 10.00 m).

Field-IQ System Status





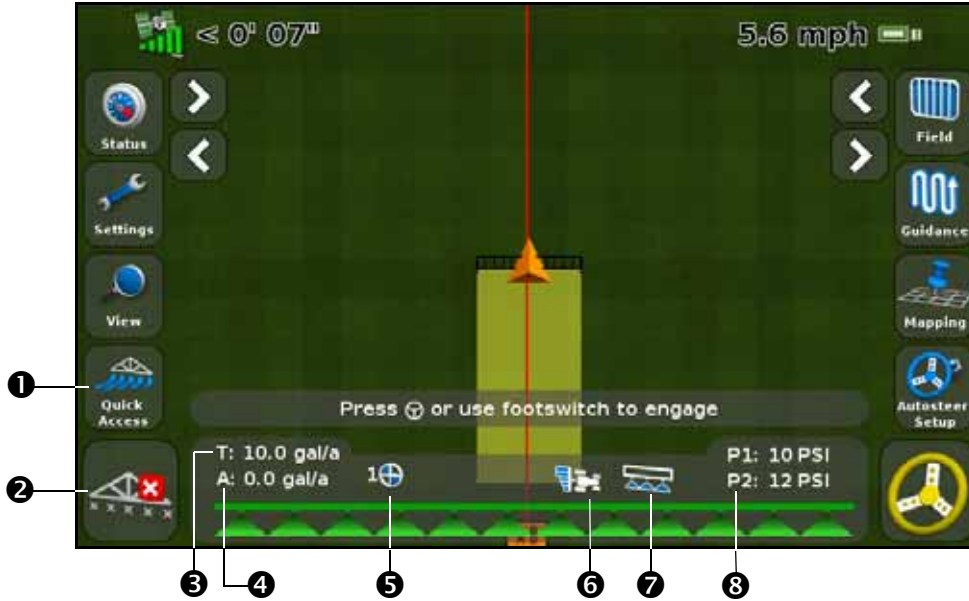

Select this option to view the status for the following:

- Master Switch Module
- Section Switch Module
- Rate Control Module
- Section Control Module
- OEM Switch Interface
- Accessories

Operation

Once you have enabled, configured and calibrated your Field-IQ crop input control system, the following items appear on the guidance screen:



Item	Description	Notes
1	Quick Access icon	See Quick Access icon , page 35
2	Coverage status	On:  Inactive:  Off: 
3	Target rate	The target application rate for the current rate switch position. This is the amount of product that you want to apply.
4	Actual rate	The actual application rate. This is the amount of product that is currently being applied.
5	Rate switch position	Indicates the current position of the rate switch.
6	Section control	Shows the current mode for the controller. Automatic:  Manual: 
7	Master switch status	Master switch on:  Master switch off: 
8	Pressure	P1: The current pressure reported by the primary pressure sensor. P2: The current pressure reported by the secondary pressure sensor.

Field-IQ master switch box

	Feature	Function
1	Increment/decrement switch	Increases the applied amount by a set amount (the amount set in the Setup screen, Rate tab).
2	Rate switch	Choose to use preset Rate 1, preset Rate 2, or Manual rate.
3	LED indicator	Red – Unit is powered but not communicating with the FM-750 display. Green – Unit is powered and communicating with the FM-750 display. Yellow – Unit is initializing communications with the FM-750 display.
4	Automatic/Manual section switch	Automatic mode – The FmX integrated display automatically opens and closes sections when entering areas of overlap, non-apply zones, or crossing boundaries. Manual mode – The sections are controlled manually, bypassing the FM-750 display. 💡 Tip – You can switch from Automatic to Manual mode while traveling.
5	Master switch	<ul style="list-style-type: none"> • A. Jump start (top position) The sections and rate are ready to be commanded by the FM-750 display, and the system is overridden to use a preset control speed (the speed is set in the Setup screen, Override tab). 💡 Tip – Use the jump start function if you lose a GPS signal or you want to start applying before your implement is up to speed. • B. On (middle position) The sections and rate are ready to be commanded by the FM-750 display. • C. Off (lower position) Sections are closed and rate is set to zero.

Note – All systems must have a Field-IQ master switch box.

Field-IQ 12-section switch box

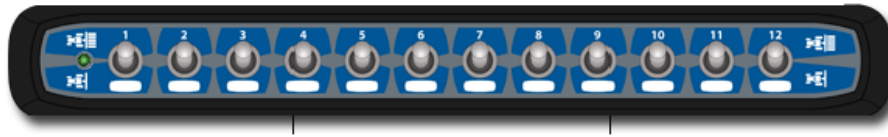

Note – The 12 section switch box is required for section control. For rate control only, the switch box is optional.

Only one section switch box can be used on each system. Each section switch is automatically assigned to the corresponding module. The modules are read from left to right. For example, switch 1 assigns to the module furthest on the left when standing behind the implement.

The section switches have different functions, depending upon the status of the master Automatic/Manual section switch on the master switch box.

When the Automatic/Manual section switch is in the **Automatic** position:

- If the section switch is in the on/up position the section(s) assigned to it are commanded automatically by the FM-750 display.
- If the section switch is in the off/down position the section(s) assigned to it are commanded to be off.

When the Automatic/Manual section switch is in the **Manual** position:

- If the section switch is in the on/up position, the section(s) assigned to it are commanded to be on. This overrides the FM-750 display and coverage logging is ignored.
- If the section switch is in the off/down position, the section(s) assigned to it are commanded to be off. This overrides the FM-750 display and coverage logging is ignored.

The LED has the following status indicators:

- Green – The unit is powered and is communicating with the FM-750 display.
- Yellow – The unit is initializing communications with the FM-750 display.
- Red – The unit is powered but not communicating with the FM-750 display.

HARDI 5500

Note – For the HARDI 5500 controller to work correctly with the FM-750 display, you must install firmware version 3.16 or greater on the HARDI controller and connect a JOBCOM control box.

Setup

1. Once you select the HARDI 5500 as your controller, the following screen appears on the display:



Note – Do not configure the display to output NMEA messages on the same port that your controller is connected to.

2. On the HARDI 5500 controller, go to the *Settings* menu.
3. Change Remote to Enable.

For more information on setting up the HARDI 5500 controller, refer to the HARDI instruction manual.

Advanced

Use the *Advanced* option in the *Implement* screen to configure the following:

- Boom Setup
- Swath Control
- Rate Control
- Off When Stopped
- Rate Snapping

Boom Setup

Note – The boom setup on the FM-750 display must match the setup on the HARDI controller. If the boom setup differs between the display and the HARDI controller, a warning message appears on the display.

Use this option to view and adjust the following settings:

Setting ...	Notes ...
Implement width	Enter a width between 1' 00" - 328' 01" (0.30 - 99.99 m).
Fence Nozzles	Enter the locations of any fence nozzles.
Number of sections	Enter a number between 1 - 10.

Swath Control

Use this option to view and adjust the following settings:

Setting ...	Notes ...
Boom control	Enter a width between 1' 00" - 328' 01" (0.30 - 99.99 m).
Coverage switching overlap	Control the amount of boom switching overlap allowed before the section will be switched by the system. Enter a value between 1 - 99%.
Boundary switching overlap	Control the amount of overlap on a boundary before the boom section is switched off. Enter a value between 1 - 99%.
On/Off valve latency	Tune the section switching to allow for hardware delays. Enter a time between 0.0 - 10.0 seconds.
Intentional overlap	Set a distance to be overlapped when moving to an unsprayed area or out of a sprayed area. Enter a distance between 0' 00" - 32' 10" (0.00 - 10.00 m).

Rate control

Use this option to view and adjust the following settings:

Setting ...	Notes ...
On	Application rates are sent from a prescription loaded in the display or the target rate manually configured on the display.
Off	The target rate must be set on the HARDI controller. The FM-750 display does not send target rates to the controller. This is the default setting.

Note – When sending a target rate to the HARDI 5500 controller that is higher than 99.9, the display rounds to the nearest whole number. For example, 0-99.9 is not rounded. 101.4 is rounded to 101.

Off When Stopped

You can use this option to control whether the system allows the vehicle to continue operating when it is not moving.

If the vehicle is a clutch-operated planter, select No so you can continue planting even when stopped.

Rate Snapping

Due to pump constraints, liquid flow is generally inconsistent. To control how these inconsistencies appear on your display, turn rate snapping on or off.

Value ...	Notes ...
On	Matches the applied rate to the target rate when within 10% of the value.
Off	Shows all fluctuations in the actual applied rate.

Operation

When you connect the HARDI 5500 controller to the FM-750 display, the following items appear on the guidance screen:



Item	Description	Notes
❶	Quick Access icon	See, Quick Access icon, page 35 .
❷	Boom section status indicators	Shows the current state of each boom section: <ul style="list-style-type: none"> Green: Enabled and spraying Gray: Enabled but not currently spraying Red: The section is off (the switch is off)
❸	Target rate	If a prescription is loaded, P displays to indicate that the prescription rate is being used rather than the target rate.
❹	Actual rate	As the HARDI controller does not report the actual applied rate to the display, this item always appears as N/A.
❺	Section control	Shows the current mode for the controller.

Item	Description	Notes
	Fence nozzle indicator	This indicator appears only when a fence nozzle is enabled. Fence nozzle status is represented with the same colors as the boom sections (see below). Note – <i>The FM-750 display cannot automatically turn fence nozzles on or off. It only displays the current status.</i>
	Application indicator	The wheel spins when the HARDI master switch is on and the booms are on.

Raven

When using the Raven SCS 400 and 600 series controller with the FM-750 display, note the following:

- The FM-750 display cannot control the status of the Raven controller master or boom switches. This means that the operator must remain in complete control of the sprayer at all times.
- The FM-750 display cannot automatically turn off the sprayer when going outside headlands, across exclusion zones, or previously sprayed areas.
- The sprayer may not always switch off completely when the FM-750 sends a zero rate. This means the operator may need to manually turn off the master switch to ensure that spray is not applied.

Note – *The only time the FM-750 display sends a zero rate is when the sprayer is outside a prescription boundary and the "Rate outside polygon" option is zero.*

- The operator must ensure that the master switch is off when there is no field open so that no spray is accidentally applied to areas that shouldn't be sprayed, for example, roads, paths, and neighboring fields.

Setup

1. Once you select Raven as your controller, the following screen appears on the display:



Note – *Do not configure the display to output NMEA messages on the same port that your controller is connected to.*

2. On the Raven controller, configure the following Data Menu settings:

Item	Setting
Baud or Baud Rate	9600
GPS	Inac
DLOG or Data Log	On
TRIG or Data Log Trigger Value	1
UNITor Data Log Trigger Units	sec

Note – In the GPS group, if ‘Send time’, ‘Time acknowledge’ or ‘Close file’ appear, change them to GPS Inac. Otherwise, the DLOG or DATA LOG option will not appear.

For more information on configuring and calibrating the Raven controller, refer to the Raven instruction manual.

Advanced

Use the *Advanced* option in the *Implement* screen to configure the following:

- Boom Setup
- Target Rate
- Rate Snapping

Boom Setup

Use this option to view and adjust the following settings:

Setting ...	Notes ...
Implement width	Enter a width between 1' 00" - 328' 01" (0.30 - 99.99 m).
Number of sections	Enter a number between 1 - 10.

Target Rate

Set the target application rate that will be sent to the Raven controller. Enter a rate between 0.0 - 11000.0.

Rate Snapping

Due to pump constraints, liquid flow is generally inconsistent. To control how these inconsistencies appear on your display, turn rate snapping on or off.

Setting ...	Notes ...
On	Matches the applied rate to the target rate when within 10% of the value.
Off	Shows all fluctuations in the actual applied rate.

Operation

When you connect the Raven controller to the FM-750 display, the following items appear on the guidance screen:

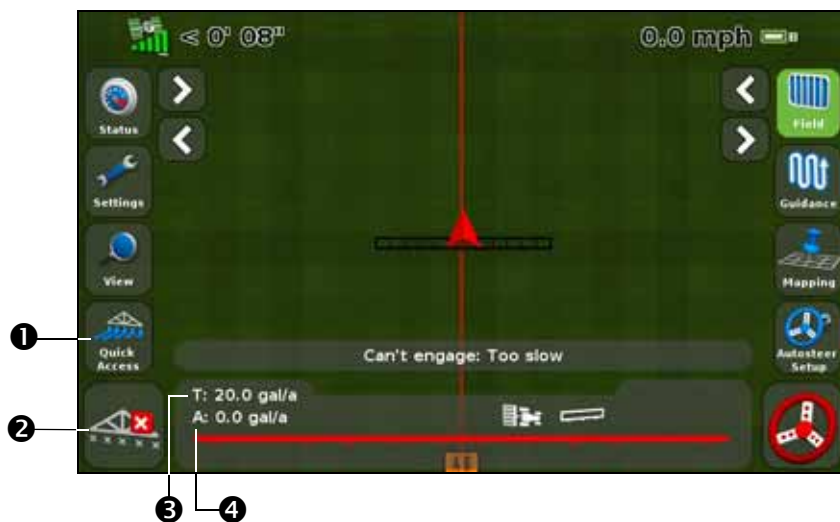

Item	Description	Notes
❶	Quick Access icon	See, Quick Access icon, page 35 .
❷	Boom section status indicators	Shows the current state of each boom section: <ul style="list-style-type: none"> Green: Enabled and spraying Gray: Enabled but not currently spraying Red: The section is off (the switch is off)
❸	Target rate	If a prescription is loaded, P displays to indicate that the prescription rate is being used rather than the target rate.
❹	Actual rate	The actual application rate. This is the amount of product that is currently being applied.
	Application indicator	The wheel spins when the Raven master switch is on and the booms are on.

Target Rate

To manually enter a rate to send to the controller:

1. In the *Settings* screen, tap **Implement** and then **Advanced**:
2. Tap **Target Rate** and then adjust the rate that is sent to the controller.

Automatic Boom Switching

The FM-750 display will not do automatic boom switching for the Raven controller.

Note – To ensure that areas outside the headland, in exclusion zones, or previously sprayed areas are not sprayed, you will need to manually turn off the Raven controller master switch.

Rawson

Setup

1. Once you select Raven as your controller, a warning message appears. Make sure that you read the message carefully, and then tap  to continue. The *Output Port* screen appears:



2. Change the Output Port to COM or AUX to match the port on the display that the controller is connected to.
3. On the Rawson controller:
 - Verify the default target rate and step size and then enter these values into the FM-750 display. To learn how to change these settings on the FM-750 display, see [Advanced](#), below.
 - Set the baud rate to 9600.

To enable the FM-750 display to change the rates on the controller, you must also set the Rawson controller to GPS mode:

1. Turn the Rawson controller on.
2. Press the MODE button twice.
3. Press the SET button to switch the controller between GPS and non-GPS modes.

Note – *If you do not set the Rawson controller to use GPS mode, the FM-750 display will only log the rates being used.*

For more information on configuring the Rawson controller, refer to the *ACCU-RATE Controller 9.2A User Guide*.

Advanced

Use the *Advanced* option in the *Implement* screen to configure the following:

- Boom Setup
- Swath Control
- Target Rate
- Default Rate
- Step Size
- Rate Snapping

Boom Setup

Use this option to view and adjust the following settings:

Setting ...	Notes ...
Implement width	Enter a width between 1' 00" - 328' 01" (0.30 - 99.99 m).
Number of sections	Enter a number between 1 - 10.

Swath Control

Use this option to view and adjust the following settings:

Setting ...	Notes ...
Boom control	Enter a width between 1' 00" - 328' 01" (0.30 - 99.99 m).
Coverage switching overlap	Control the amount of boom switching overlap allowed before the section will be switched by the system. Enter a value between 1 - 99%.
Boundary switching overlap	Control the amount of overlap on a boundary before the boom section is switched off. Enter a value between 1 - 99%.
On/Off valve latency	Tune the section switching to allow for hardware delays. Enter a time between 0.0 - 10.0 seconds.
Intentional overlap	Set a distance to be overlapped when moving to an unsprayed area or out of a sprayed area. Enter a distance between 0' 00" - 32' 10" (0.00 - 10.00 m).

Target Rate

Set the target application rate that will be sent to the Rawson controller. Enter a rate between 0.0 - 11000.0.

Alternatively, you can load a prescription so the FM-750 display will automatically send target rates to the Rawson controller.

Note – When the FM-750 display is sending target rates to the Rawson controller, the Rawson controller will only display the Target Rate screen. To change or view any other screen on the Rawson controller, you must unplug the FM-750 display cable.

***Note** – When using a prescription with the Rawson controller, the target rates in the prescription must match the step sizes in the Rawson controller. For example, if the default is 25000 and the step size is 4%, then the target rate values accepted by the Rawson controller are 26000, 27000, 28000...40000. Otherwise, the Rawson controller may not be able to apply the correct rate.*

Default Rate

On the FM-750 display, set the same target rate that appears on the Rawson controller when you first power up it up. Enter a number between 0 - 9999000.

Step Size

The step size increases or decreases the actual applied rate by the percentage that you select. You can choose from one of the following settings:

- 2%
- 4%
- $6\frac{2}{3}\%$

Rate Snapping

Due to pump constraints, liquid flow is generally inconsistent. To control how these inconsistencies appear on your display, turn rate snapping on or off.

Setting ...	Notes ...
On	Matches the actual applied rate to the target rate when within 10% of the value.
Off	Shows all fluctuations in the actual applied rate.

Amazone

Setup

1. Once you select Amazone as your controller, the following screen appears on the display:



Note – Do not configure the display to output NMEA messages on the same port that your controller is connected to.

2. On the Amazone controller, go to the *Settings* menu.
3. Change Remote to Enable.

For more information on setting up the Amazone controller, refer to the Amazone instruction manual.

Advanced

Use the *Advanced* option in the *Implement* screen to configure the following:

- Boom Setup
- Swath Control
- Rate Control
- Target Rate
- Turn Off Rate on Overlap
- Rate Snapping

Boom Setup

Note – The boom setup on the FM-750 display must match the setup on the Amazone controller. If the boom setup differs between the display and the Amazone controller, a warning message appears on the display.

Use this option to view and adjust the following settings:

Settings ...	Notes ...
Implement width	Enter a width between 1' 00" - 328' 01" (0.30 - 99.99 m).
Fence Nozzles	Enter the locations of any fence nozzles.
Number of sections	Enter a number between 1 - 10.

Swath Control

Use this option to view and adjust the following settings:

Settings ...	Notes ...
Boom control	Enter a width between 1' 00" - 328' 01" (0.30 - 99.99 m).
Coverage switching overlap	Control the amount of boom switching overlap allowed before the section will be switched by the system. Enter a value between 1 - 99%.
Boundary switching overlap	Control the amount of overlap on a boundary before the boom section is switched off. Enter a value between 1 - 99%.
On/Off valve latency	Tune the section switching to allow for hardware delays. Enter a time between 0.0 - 10.0 seconds.
Intentional overlap	Set a distance to be overlapped when moving to an unsprayed area or out of a sprayed area. Enter a distance between 0' 00" - 32' 10" (0.00 - 10.00 m).

Rate control

Use this option to view and adjust the following settings:

Settings ...	Notes ...
On	Application rates are sent from a prescription loaded in the display or the target rate manually configured on the display.
Off	The target rate must be set on the Amazone controller. The FM-750 display does not send target rates to the controller. This is the default setting.

Note – When sending a target rate to the Amazone controller that is higher than 99.9, the display rounds to the nearest whole number. For example, 0-99.9 is not rounded. 101.4 is rounded to 101.

Target Rate

Set the target application rate that will be sent to the Amazone controller. Enter a rate between 0.0 - 11000.0.

Turn Off Rate on Overlap

Use this option to view and adjust the following settings:

Settings ...	Notes ...
Yes	Does not spray over an area that has been previously sprayed.
No	Sprays over an area that has been previously sprayed.

Operation

When you connect the Amazone controller to the display, the following items appear on the display's guidance screen:

Item	Notes
Actual rate	
Target rate	If a prescription is loaded, P displays to indicate that the prescription rate is being used rather than the target rate.
Boom section status indicators	Shows the current state of each boom section: <ul style="list-style-type: none">• Green: Enabled and spraying• Gray: Enabled but not currently spraying• Red: The section is off (the switch is off)
Application indicator	The wheel spins when the Amazone master switch is on and the lightbar receives flow messages from the controller.
Quick Access icon	See, Quick Access icon, page 35 .

LH 5000

Setup

1. Once you select the LH5000 as your controller, the following screen appears on the display:



2. On the FM-750 display, make sure that Output Port matches the port on the display that the controller is connected to (COM or AUX).
3. Do not configure the display to output NMEA messages on the same port that your controller is connected to.

For more information on configuring the LH 5000 controller, refer to the LH 5000 instruction manual.

Advanced

Use the *Advanced* option in the *Implement* screen to configure the following:

- Boom Setup
- Swath Control
- Rate Control
- Target Rate
- Turn Off Rate on Overlap
- Rate Snapping

Boom Setup

Note – The boom setup on the FM-750 display must match the setup on the LH 5000 controller. If the boom setup differs between the display and the LH 5000 controller, a warning message appears on the display.

Use this option to view and adjust the following settings:

Setting ...	Notes ...
Implement width	Enter a width between 1' 00" - 328' 01" (0.30 - 99.99 m).
Fence Nozzles	Enter the locations of any fence nozzles.
Number of sections	Enter a number between 1 - 10.

Swath Control

Use this option to view and adjust the following settings:

Setting ...	Notes ...
Boom control	Enter a width between 1' 00" - 328' 01" (0.30 - 99.99 m).
Coverage switching overlap	Control the amount of boom switching overlap allowed before the section will be switched by the system. Enter a value between 1 - 99%.
Boundary switching overlap	Control the amount of overlap on a boundary before the boom section is switched off. Enter a value between 1 - 99%.
On/Off valve latency	Tune the section switching to allow for hardware delays. Enter a time between 0.0 - 10.0 seconds.
Intentional overlap	Set a distance to be overlapped when moving to an unsprayed area or out of a sprayed area. Enter a distance between 0' 00" - 32' 10" (0.00 - 10.00 m).

Rate control

Use this option to view and adjust the following settings:

Setting ...	Notes ...
On	Application rates are sent from a prescription loaded in the display or the target rate manually configured on the display.
Off	The target rate must be set on the LH 5000 controller. The FM-750 display does not send target rates to the controller. This is the default setting.

Note – When sending a target rate to the LH 5000 controller that is higher than 99.9, the display rounds to the nearest whole number. For example, 0-99.9 is not rounded. 101.4 is rounded to 101.

Target Rate

Set the target application rate that will be sent to the LH 5000 controller. Enter a rate between 0.0 - 11000.0.

Turn Off Rate on Overlap

Use this option to view and adjust the following settings:

Setting ...	Notes ...
Yes	Does not spray over an area that has been previously sprayed.
No	Sprays over an area that has been previously sprayed.

Operation

When the LH 5000 variable rate controller is connected to the display, the following items appear on the FM-750 display's guidance screen:

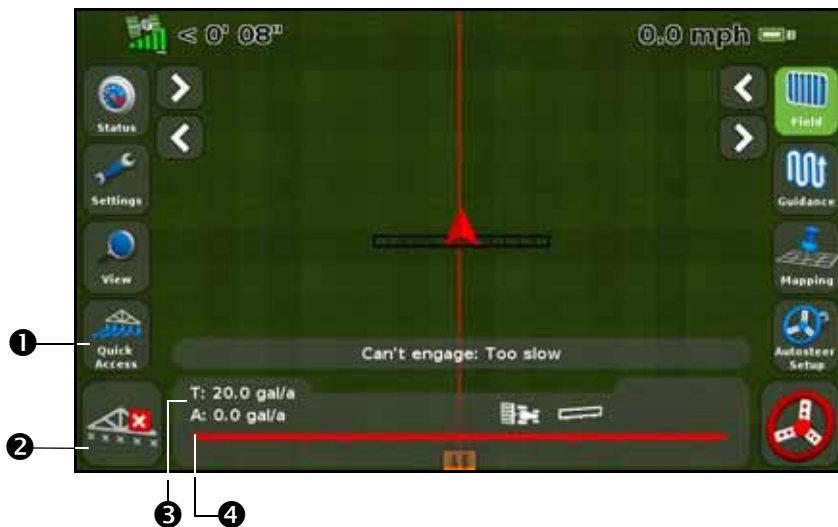

Item	Description	Notes
①	Quick Access icon	See, Quick Access icon , page 35.
②	Boom section status indicators	Shows the current state of each boom section: <ul style="list-style-type: none"> Green: Enabled and spraying Gray: Enabled but not currently spraying Red: The section is off (the switch is off)
③	Target rate	If a prescription is loaded, P displays to indicate that the prescription rate is being used rather than the target rate.
④	Actual rate	The actual application rate. This is the amount of product that is currently being applied.
	Application indicator	The wheel spins when the LH 5000 master switch is on and the lightbar receives flow messages from the controller.

Checking the implement connection

To check that the FM-750 display and your implement controller are communicating correctly, access the *VR Controller Status* screen:

1. In the *Settings* screen, tap **Vehicle** and then tap **Status**.
2. Tap **VR Controller Status**. A screen similar to the following appears:

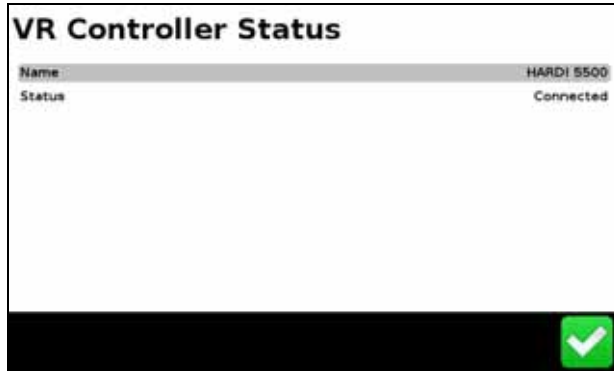

3. Check that the status displays *Connected*.

Note – *If the status displays Not Connected, verify that the controller cable is securely connected to the display. If the cable is secure, verify that the display and the controller are configured correctly, as detailed in the sections below.*

Mapping and Guidance

In this chapter:

- Introduction
- Configuring the Guidance settings
- Starting Guidance
- Fields
- Resetting guidance
- Guidance lines
- Guidance Patterns
- Coverage logging
- The pause / resume function
- Curve smoothing

This chapter describes the type of guidance information that the FM-750 display provides.

Introduction

While you work, guidance information appears on the FM-750 display screen and the integrated lightbar that indicate the:

- position of your vehicle in the field
- guidance lines
- offline distance

To receive this guidance information (and any assistance from an auto steer system) you must do the following:

1. Configure how the guidance displays on your screen. See [Configuring the Guidance settings](#), below.
2. Set a guidance line. See [Guidance lines](#), page 98.
3. Configure the lightbar. See [Lightbar Setup](#), page 124.

Configuring the Guidance settings

To configure your Guidance settings:

1. From the guidance screen, tap .
2. From the *Settings* screen, tap **Guidance**.



3. Select the options that you would like to configure.

Option	To learn more, see ...
Turn Settings	page 91
Coverage Settings	page 92
Nudge Settings	page 92
Mapping	page 92
FreeForm Recording	page 93
Headland/Infill Switching	page 93
Boundary Setup	page 94

Turn Settings

The available Turn Settings are described below.

Minimum turn radius mode

This setting smoothes corners on curved AB lines, which optimizes the accuracy of your auto steer system when steering curves.

Use this mode ...	To ...
Automatic (This is the default mode.)	Set the radius to 80% of the swath width or 32.8' (10 m), whichever is larger.
Disabled	No attempt is made to keep the corners above a minimum turn radius. Note – <i>If you use this mode, curves may be very tight and the auto steering system may be unable to successfully complete the turn.</i>
Manual	Manually choose the minimum radius.

Tight turn alert threshold

The FM-750 display alerts you when your machine is within a specified distance of a tight turn.

The threshold is set between 1 and 10. To increase the sensitivity of the alert, lower the number.

Auto U-turn detection

Auto U-turn detection operates only on FreeForm and adaptive curve patterns. For more information, see [Guidance Patterns, page 99](#).

Use this mode ...	To ...
On	Automatically detect that the vehicle has done a U-turn and generate the next guidance line.
Off	Manually control when a path is finished. With the FreeForm pattern you must manually stop recording. With the adaptive curve pattern you must manually set the B point.

Coverage Settings

Configure the *Coverage Settings* options to suit the requirements of your system.

Coverage on/off delay

If you activate coverage logging at the same time as you enable your spraying or spreading system, set a coverage delay that matches the time it takes for flow to start when you turn on your spraying/spreading system. This ensures that the display records coverage from the actual start point of application. You can enter a delay time between 0.0 - 10.0 seconds.

Coverage logging

Use this mode ...	To ...
Disabled	Turn coverage logging off.
Manual	Turn coverage logging on and off manually.
Engaged	Automatically enable coverage logging when the auto steer system is engaged.
Switch	Use a remote switch to turn coverage logging on or off.

Nudge Settings

Option	Description
Clear nudge at swath end	When enabled, the display clears the nudged position each time you change swaths.
Reset nudge	When enabled, any applied nudge is cleared and all swaths return to their original positions.
Nudge increment	Each nudge moves the guidance line by this value. The default nudge increment is 0' 1" (2.5 cm). Enter a value between 2 - 12" (3 - 30 cm).

Mapping

Use this setting to set warning distance and recording positions for the following features:

- Point
- Line
- Area

Warning distance

You can set a warning distance so that the FM-750 display alerts you when your machine approaches a feature.

As the machine moves to within the specified distance, a warning screen appears on the display. If you have an EZ-Steer or Autopilot system with a sonalert connected, an audible alarm also sounds.

You can set the warning distance to between 0'00" - 984' 03" (0.0 - 300.0 m).

Recording position



Choose the point at which a feature is recorded. When your vehicle is at this point, the feature will be recorded.

Delete features

Use this function to delete point, line and area features from a selected field. Note that this function deletes only the features, not the field itself.

FreeForm Recording

Use this setting to choose how the display records a FreeForm pattern:

Choose this mode ...	If you want to ...
Manual	Use the icons on the guidance screen to control when the path is recorded. To start recording tap  , to stop, tap  .
Record with coverage	Automatically begin and end recording the FreeForm pattern when coverage logging begins and ends. Note – You can still use the FreeForm recording icon to manually override recording.

Headland/Infill Switching

Use this setting to choose how guidance switches between the headland and the infill part of the field:

Select this mode ...	To ...
Automatic	Automatically switch from headland to infill when the vehicle moves inside the inner headland boundary.
Manual	Use the icons on the guidance screen to select when guidance switches from headland to infill.

Boundary setup

Use the Boundary Setup option to configure:

- when boundaries are active. See [Boundaries](#), below.
- how the display records boundaries. See [Expand Boundaries](#), below.

Note the following:

- When you record a boundary, the display automatically calculates the area of the boundary and displays this information on the Status tab.
- When you load a field that contains a boundary, the boundary also loads.
- You can record multiple boundaries in a single field.
- If your variable rate controller has section switching capability, a boundary acts as a switching barrier. When you move outside the boundary, the controller will automatically switch off the implement.

Boundaries

Select this mode ...	To ...
Enabled	Use existing boundaries and create new ones for all your fields.
Disabled for this field	Turn off boundaries for only the current field you are working in. When you begin your next field, the option will automatically change to Enabled.
Disabled for all fields	Turn off boundaries for all fields you work in, including boundaries made with headland patterns.

Expand Boundaries

Use this setting to determine how the display manages the boundary after you finish recording.

If you select this mode ...	The boundary will ...
Do not expand	Not alter once you have finished recording
Half swath width	Expand by one half swath width toward the outside of the pass
One swath width	Expand by one full swath width toward the outside of the pass

Starting Guidance

Before you can use the display for guidance, you must configure your implement:

1. From the guidance screen, tap  and then tap **Create New Field**.
2. In the *Create New Field* screen, tap **Implement Setup**.

3. Edit the settings for each option. For more information, see [Implement Setup options, page 95](#).
4. Select a pattern type (see [Guidance Patterns, page 99](#)) and continue through the wizard.

Implement Setup options

For optimum guidance, make sure that you enter accurate information for the implement that is attached to the vehicle. Incorrect information may result in gaps and overlaps in coverage.

The following table describes each of the Implement Setup options:

Option	Enter a measurement between ...	This adjusts guidance and coverage logging when ...	Notes
Implement Width	1' 00" - 328' 01" (0.305 - 99.990 m)		
Overlap/Skip	394" skip and 394" overlap (1000 cm).		<ul style="list-style-type: none"> • To avoid skips in application coverage, set an intentional overlap.
Left/Right Offset	1969" right and 1969" left (5000 cm).	The implement is offset from the vehicle center line.	<ul style="list-style-type: none"> • When configured and online, the implement should be over the guidance line, with the vehicle to the side. • For guidance when driving, use the LEDs on the lightbar. For more information, see Reading lightbar patterns, page 39.
Forward/Back Offset	1188" behind and 384" forward (3018 cm - 975 cm)	The implement is not centered directly under the GPS antenna (for EZ-Steer systems) or the fixed axle of the vehicle (for Autopilot systems).	<ul style="list-style-type: none"> • Set a Forward Offset when the implement is forward of the antenna (on the front of the vehicle) for EZ-Steer systems, or forward of the fixed axle of the vehicle for Autopilot systems. • Set a Back Offset when the implement is behind the antenna (on the back of the vehicle) for EZ-Steer systems, or behind the fixed axle of the vehicle for Autopilot systems.
Implement Draft	393.7" left and 393.7" right (1000.0 cm).	There is a variable implement draft caused by a side slope and/or an implement pulling to one side.	
Implement Mount Type			Choose the type of implement mount that is in use

Using guidance on curved segments

After you have defined a guidance line, there are two ways to get guidance:

- Drive the vehicle through a tight U-turn. The next guidance line appears.
- If you are manually logging a FreeForm curve, tap  to stop defining the current line.

The FreeForm curve is similar to an adaptive curve. You must record your line on each pass to receive guidance on the next. If the vehicle is not drawing a line (or guidance trail) behind it, you are not recording your path and therefore the next guidance line will not appear.



***Note** – Do not confuse the existing guidance line with the guidance trail appearing behind the vehicle that shows your current guidance. You need to create a new guidance line to receive guidance on the next pass.*

Using guidance on straight segments

When driving on straight AB lines, you do not have to record your path because the guidance lines are generated automatically.

Creating straight sections on Headland or Curve swaths

To create straight sections when recording headland or curve swaths:

1. Tap .
2. Drive the section.
3. Tap  to finish recording the straight section and to start recording a curve again.

Fields

A “field” is specific area of land where events (such as planting seed or applying fertilizer) are carried out.

You create your first field when you first configure your implement (see [Starting Guidance, page 94](#)). That field remains open until you do one of the following:

- Create a new field, or load a previously saved field
- Calibrate your EZ-Steer system
- Perform a hard reset

***Note** – Fields are stored automatically. You do not have to actively save a field.*

The following sections describe how to use the field function when there is already a field currently loaded on the display.

Creating a new field

1. In the guidance view tap . The *Finished with Field* screen appears.
2. Tap **Yes**.
3. In the *Create New or Select Old Field* screen, tap **Create New Field**.
4. To setup the new field, progress through the wizard.
5. Follow the on screen instructions to drive your new line. For more information, see [Mapping an AB line, page 100](#).

Selecting (loading) a field

1. In the guidance view tap . The *Finished with Field* screen appears.
2. In the *Finished with Field* screen tap **Yes**.
3. In the *Create New or Select Old Field* screen, tap **Select Field by Name**.
4. In the *Select Field by Name* screen, select the field you wish to load.
5. To setup the field, progress through the wizard.

Adding an AB line to a current field

To create a new AB line in a current field:

1. In the guidance view tap . The *Finished with Field* screen appears.
2. In the *Finished with Field* screen tap **No**.
3. In the *Create New or Select Old Swath* screen, tap **Add AB Line**.
4. To setup the new field, progress through the wizard.
5. Follow the on screen instructions to drive your new line. (For more information, see [Mapping an AB line, page 100](#)).

Selecting (loading) an AB line into a field

1. In the guidance view tap . The *Finished with Field* screen appears.
2. In the *Finished with Field* screen tap **No**.
3. In the *Create New or Select Old Swath* screen, tap **Select Old**.
4. To setup the new field, progress through the wizard.
5. Follow the on screen instructions to drive your new line. For more information, see [Mapping an AB line, page 100](#).

Record keeping

Optionally, you can record operational and environmental information about each field that you create, including:

- Operator
- Farm location
- Application method
- Wind direction
- Temperature
- Target pests
- EPA license number
- Vehicle
- Wind speed
- Sky conditions
- Humidity
- Applied material
- Harvest year
- Implement
- Wind gust speed
- Soil conditions
- Crop

Additionally, there are four custom fields where you can enter your own values.

To learn how to use this information, see [Chapter 8, Data](#).

Resetting guidance

To reset guidance, in the guidance view, tap . The *Finished with Field* screen appears:



To map a new:

- **field** or select an existing field, select *Yes*.
- **AB line** or select an existing AB line in the current field, select *No*.

Note – If you select ‘Yes’, then the current field automatically closes. This means that you cannot cancel out of the New Field wizard and go back to your current field.

Guidance lines

To create a guidance line, you define a start point (A) and an end point (B). Once you define the A and B points, the display draws a line between them. This is the master AB line.

Note – AB lines are stored automatically. You do not have to actively save an AB line.

When you define the first guidance line, the display copies it to create additional guidance lines.

Distance between guidance lines





When you define the AB line, you specify the width of the implement that is attached to the vehicle. The display uses this measurement to calculate the distance between the guidance lines. If you do not want the guidance lines to be exactly one implement width apart, you can set an overlap or skip.

Headlands

You can record a headland boundary, or you can work without a headland.

On screen appearance

When the guidance screen shows the trailing view, it tags the guidance lines with the following icons:

These icon/s	Are tagged to ...
	The master line that you created. The swaths are based on this line.
 	The A (start) and B (end) point on the master line.
	The first swath to the left of the master line, where 'left' is relative to the direction the master line was drawn, not the vehicle's current position. Note the following: <ul style="list-style-type: none"> • The current swath and tag are orange. • On a Pivot pattern, the swaths are numbered out from the center, not from the initial swath.
	The second line to the left of the master line.

Guidance Patterns

Select a guidance pattern that enables you to create a guidance line to suit your field:

1. From the guidance screen, tap  and then tap **Create New Field**.
2. In the *Create New Field* screen, tap **Pattern Type**:

3. Select the pattern that you want to use:

Pattern	To learn more, see ...
Straight AB	page 100
A+ line	page 100
Identical curve	page 101
Adaptive curve	page 101
Pivot	page 103
Headland	page 103
FreeForm	page 105



Straight AB

Use a straight AB line when you do not need to define headlands and you want to drive the field in parallel straight lines.

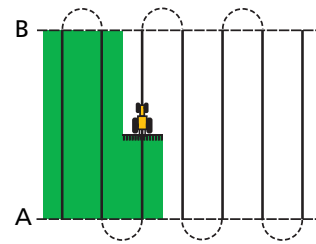
Note – When the vehicle is on a guidance line, the line extends 1 km (0.6 miles) before point A and 1 km beyond point B. This makes it easier to see where the next swath is and to get online after a turn.



Mapping an AB line

1. Drive to the start point of the master line.
2. Tap  and then drive to the end of the line.
3. When the icon is highlighted, tap . The master AB line appears.
4. Turn left or right for the next swath. As you move toward the next swath, it appears on the screen and turns orange to show that it is selected.

A+

An A+ line is a straight line, defined by a single A point on the line and the heading of the line. When you create an A+ line, you must enter a heading in the *A+ Heading* screen. By default, the A+ heading is the same as the previous AB line.

An A+ line is useful when you need guidance exactly parallel to the last AB line, for example when:

- driving adjacent fields
- mapping the AB line on a road down the side of the field
- skipping an access road in a field

The A+ line extends 1 km (0.6 miles) before and after the A point.

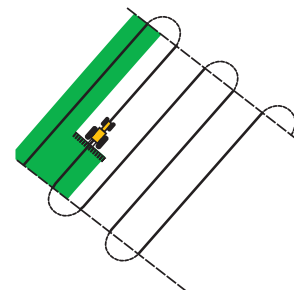

Mapping an A+ line

1. Drive to the start point of the master line.
2. Tap  and then drive to the end of the line. Because you have already set the line heading, the master AB line appears on the screen.
3. For guidance down the first swath follow the AB line.
4. Turn left or right for the next swath. As you move toward the next swath, it appears on the screen and turns orange to show that it is selected.



Identical curve

The identical curve pattern records your exact route between the A and B points, instead of creating a straight line. All subsequent guidance lines will match the master curve, regardless of where you drive the vehicle.

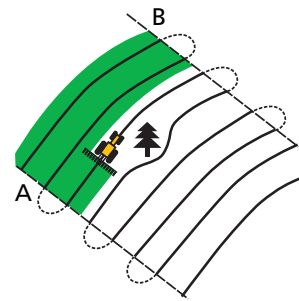
Use the identical curve pattern when you want to work a field with gentle curves.



Mapping an identical curve

1. Drive to the start point of the curve.
2. Tap  and then drive the initial curve.
3. When the icon is highlighted, tap . The master curve appears on the screen.
4. Turn left or right for the next swath. As you move toward the next swath, it appears on the screen and turns orange to show that it is selected.

Adaptive curve

The adaptive curve pattern provides guidance along a curve and updates guidance after each swath to take into account any deviations you make. It continually records your path and provides guidance that matches the last path you drove.

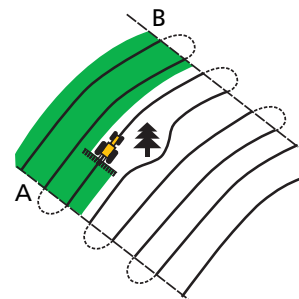

Mapping an adaptive curve

You can map an adaptive curve either manually or automatically. The method you use depends on the Auto U-turn detection setting.

To change the Auto U-turn detection setting:



1. In the *Settings* screen, tap **Guidance**.
2. Tap **Turn Settings**, then **Auto U-Turn Detection**.

3. If you want to map the adaptive curve:
 - Automatically; select *On*.
 - Manually; select *Off*.

To map an adaptive curve with automatic turn detection:

1. Drive to the start point of the curve.
2. Tap  and then drive the initial curve.
3. At the end of the first curve, perform a U-turn. The system detects the turn and generates the next swath.

To map an adaptive curve manually:

1. Drive to the start point of the curve.
2. Tap  and then drive the initial curve.
3. At the end of the first curve, tap . The system generates the next swath.
4. Continue to drive the swaths, setting the B point at the end of each one.

Using the adaptive curve pattern for row-finding

1. Set *Auto U-Turn Detection* to *Off*.
2. Create a guidance line based on the adaptive curve pattern.
3. Set the B point at the end of each row.
4. Turn the vehicle toward the next swath. When the vehicle is halfway through the turn, guidance along the next swath appears.

Pivot

Use the pivot pattern on fields that use center-pivot irrigation. With this pattern you can drive concentric circles around the center-pivot.

To map a pivot:

Note – Always set the master line near the outer edge of the field.

1. Drive to the start point of the pivot.
2. Position one wheel of the vehicle in a pivot wheel rut, with the rear of the vehicle to the pivot arm. If the field is not a full circle pivot, face the rear of the vehicle to the edge of the field.
3. Tap  and then drive around the field. Keep the vehicle in the rut. The display will generate guidance swaths.
4. Turn left or right for the next swath. As you move toward the next swath, it appears on the screen and turns orange to show that it is selected.

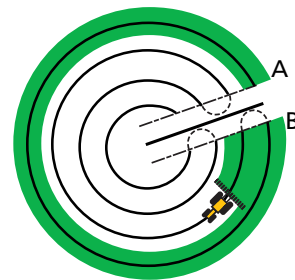

- Steer the vehicle so that the lit LEDs are centered on the lightbar as you drive forward along the swath.

Headland

The headland pattern enables you to define the boundary (headland) of the area, as well as the guidance lines contained within it. Use the headland pattern to allow room to turn.

The following diagrams show the two headland patterns:

Single

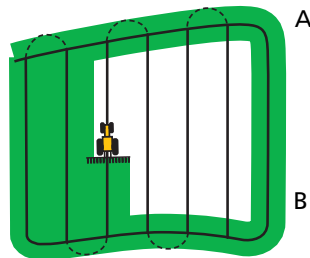

Multiple

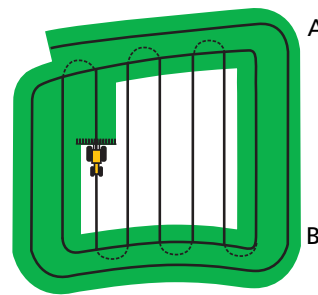

When you start to define the headland, you define the internal guidance line as you drive around the headland, and then you complete the headland.

You can change two settings for the headland pattern:

- The number of circuits.
- The internal pattern.

Number of circuits

When you create a headland, you need to specify the total number of circuits (including the master headland). This defines how wide the headland is.

Note – No matter how many circuits you create, only define the outside headland. The inner headlands are copied from that original circuit.

Internal pattern

The internal pattern is the pattern of the guidance lines inside the headland. Choose from the following:

Choose this pattern ...	To create ...
Straight AB	Standard parallel swaths inside a headland
A+	Parallel swaths at a pre-defined heading

Reselecting the headland



When you use the headland pattern you can see either the headland or the internal pattern.

To see the headland guidance again when you are driving the internal pattern, drive into the headland before the first internal swath or after the final internal swath. The headland appears automatically.

Mapping a headland

1. Drive to the start point of the headland.
2. Tap  to set the start point of the headland.
3. Begin to drive the circuit of the headland.

Note – To ensure straight sides on the headland, you can use the pause feature. See [Creating straight sections on Headland or Curve swaths, page 96](#).

4. Tap  to set the A point of your guidance line. If the internal pattern is an:
 - A+ line, the line is set.
 - an AB Line, continue to drive around the headland. When you reach the other end of the internal guidance line, tap  to set the B point.

When you have defined the internal pattern guidance line, the start-point circle appears around the start point of the headland.

Note – If you return to the start of the headland before you define a guidance line, the headland will not complete.

5. To complete the headland, do one of the following:

Note – Define the master line for the internal pattern before you complete the headland.

- Drive around the rest of the headland until you return to the start-point circle. When you drive into the start-point circle, the headland completes automatically.
- Drive part of the headland and then tap . The headland completes with a straight line from the vehicle position back to the start point.

Once you have completed the headland, the headland guidance line appears.

When the vehicle moves out of the headland and into the interior of the pattern, the interior is populated with your selected the guidance line pattern (straight AB or A+).

FreeForm

Use this pattern type to create curved and straight lines for guidance in fields of any shape.



The display records the exact path you drive, and uses this to generate the next guidance line.

To select the FreeForm recording option:

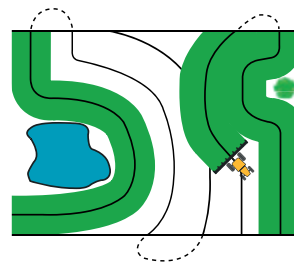

1. In the *Settings* screen, tap **Guidance** and then **FreeForm Recording**.
2. Tap **Manual** or **Record with coverage**.



Recording a FreeForm curve



1. Drive to the start point of the FreeForm curve.
2. To:
 - use *Manual* recording, tap .
 - *Record with Coverage* tap either  or .

While the display is recording the current path,  appears on the guidance screen.

3. Drive the curve. To record straight sections, you can use the pause feature. See [Creating straight sections on Headland or Curve swaths, page 96](#)
4. To finish recording, do one of the following:
 - If Auto U-Turn Detection is on, perform a tight U-turn.
 - For *Manual* recording, tap .
 - If you are using *Record with Coverage*, tap  or .

Note – If Auto U-Turn Detection option is off, you must manually stop recording at the end of each pass and then start recording again at the beginning of the next pass.

Using the FreeForm pattern to define a straight AB line

1. Tap  and then drive to the end of the line.
2. At the end of the line, tap .

Switching to another line

To switch from the current FreeForm guidance line to another, tap .

The first time you tap the icon, guidance snaps to the next nearest curve. Continue tapping the icon to cycle through other guidance lines.

Note – To use this feature, the vehicle must be within 1.5 swath widths of a FreeForm curve.

Using FreeForm curves in spiral fields

If you are creating a spiral into the center of the field, drive the full circuit and then back onto the start of the FreeForm curve. Continue to record your guidance path as you spiral toward the center of the field.

If you encounter an obstacle in the field, continue to record your path as you drive around it. On the next pass the guidance line will adjust to reflect this.

Note – When you create a spiral with the FreeForm guidance pattern, there may be a space at the center of the spiral.

Using FreeForm curves in fields with variable terrain



Start and stop recording guidance at the ends of each pass. If there are two guidance lines in close proximity, tap  to snap to the correct line.

At any point you can add a straight AB line for repeated straight line guidance.

Tap  to switch between straight AB and FreeForm curve guidance lines.

Coverage logging

Coverage logging draws a solid block of color behind the vehicle to show the area that you have applied. When you pass over an area for the second time, the color of the covered area changes. This is useful for viewing overlaps.

To begin coverage logging tap  while you are driving; to finish coverage logging tap .

Note – There may be a delay between the time you start or stop coverage logging onscreen and the time the implement actually starts or stops coverage. To compensate for this you can add a time delay to the drawing of coverage logging. See [Coverage on/off delay](#), page 92.

Note – Field coverage is limited to 1000 acres for each event.

The pause / resume function

When you tap Pause , an icon appears on the screen to show your exact location when the guidance was paused. This enables you to return to that position in the field.

When you pause guidance:

- Your current position relative to the pause icon appears in the status bar at the top of the screen.
- The guidance line that you were on is displayed, even if you drive onto another swath.
- The pause/resume icon remembers the vehicle position even when the lightbar is turned off.

Curve smoothing

By default, the FM-750 display smooths curves for improved guidance and auto steering. You can disable curve smoothing on tight turns (curves that have a radius of less than 3m (10 ft.).

***Note** – If you disable curve smoothing, the FM-750 display or the Autopilot system may not be able to auto steer around the tighter turns. Be careful when you disable curve smoothing.*

To disable curve smoothing:

1. In the *Settings* screen, tap **Guidance** and then tap **Turn Settings**.
2. Tap **Minimum Turn Radius Mode** and then select **Automatic, Disabled** or **Manual**.

GPS

In this chapter:

- [Introduction](#)
- [GPS Setup](#)
- [Position Quality](#)
- [Advanced](#)
- [Status](#)

This chapter describes how to set up the GPS receiver.

Introduction

The *GPS* menu enables you to select which GPS system and correction source to use, and the GPS quality tolerance.

To access the menu:

1. From the guidance screen, tap  .
2. From the *Settings* screen, tap **GPS**:



GPS Setup

Use the *GPS Correction Source* screen to choose the type of GPS position corrections that you want to use:

Source	Description
SBAS (Satellite-based augmentation system)	Free satellite-based corrections: <ul style="list-style-type: none"> • WAAS (Wide Area Augmentation System) in North America • EGNOS (European Geostationary Navigation Overlay Service) in Europe
OmniSTAR VBS	Satellite-based subscription correction service
OmniSTAR XP/HP	High accuracy satellite -based subscription correction service
RTK (Real Time Kinematic)	Radio-broadcast corrections from a ground-based reference station
Uncorrected	No GPS corrections

Position Quality

GPS signals can be disrupted by foliage, or when the machine moves out of sight of one or more satellites, or when one or more satellites move out of sight of the machine or 'set' below the horizon.

The *Position Quality* screen provides options that allow you to operate when the quality of GPS position information is compromised.

Option	Description
Favor Accuracy	Provides the highest level of accuracy.
Balanced Quality	Trades potential accuracy for a slight increase in production time.
Favor Availability	Extends production time further, with more potential for reduced accuracy.

Advanced

The *Advanced* screen enables you to view and adjust advanced GPS settings.



Antenna Type

Access the *Antenna Type* screen to alter the internal settings of the GPS receiver to ensure optimum accuracy for the antenna.

Select the antenna you have connected to the display. The AG15 and AG25 antennas are white and dome shaped.

Use SBAS satellites in the position fix

Choose this option if you want to use SBAS corrections from WAAS satellites to calculate the GPS positions. For example, if the display receives position information from six standard GPS satellites and two WAAS satellites, the display uses all eight satellites to calculate the GPS position.

This can extend operating time when limited number of satellites are available.

Note – This option does not work with EGNOS satellites, OmniSTAR or RTK corrections.

Force GPS Iono

Choose *On* to force the use of modeled rather than real-time ionosphere data.

This setting is designed primarily for locations at the edge of SBAS coverage, such as northern Canada, and could affect accuracy if used elsewhere.

OnPath Filter

Use the *OnPath Filter* option to detect and eliminate GPS position jumps and significantly improve pass-to-pass accuracy. Select the option that best describes the surrounding environment.

Satellite Health

You can use this setting to disregard signals from a specific satellite due to concerns about its state. For more information, contact your reseller.

Status

The *Status* screen enables you to view the current status of the GPS functions.



GPS Status

The *GPS Status* screen displays information about your position and the current GPS signal strength.

Satellite Status

The *Satellite Status* screen displays information about the current satellite constellation.

The information for each satellite is contained in one line. The following table describes fields that the line contains:

Field	Description
Sv	Satellite number Note – <i>GLONASS</i> satellites have an "R" in front of the satellite number; <i>GPS</i> satellites do not.
El	Elevation
Az	Azumith
L1	L1 SNR
L2	L2 SNR
Corr	Correction (Only appears if correction is applied)
Used	Used (Only appears if the satellite is used in position calculation)

DGPS Status

The *DGPS Status* screen displays which DGPS signal is selected from the GPS Correction Source screen. For more information, see [GPS Setup, page 110](#).

Filter Status

The *Filter Status* screen provides diagnostic information about the OnPath[®] advanced filter technology.

Data

In this chapter:

- [Introduction](#)
- [Connected Farm Setup](#)
- [Manage Data](#)

The FM-750 display saves field data to the display's internal memory. You can transfer this data to your home or office computer via a USB drive, or wirelessly through the Connected Farm server.

This chapter describes how to manage the data generated by the FM-750 display.

Introduction

Use the options in the *Data* menu to:

- Save and retrieve fields from the USB drive.
- Send fields (via Connected Farm) to your home or office PC.
- Delete fields and coverage logging.
- Export diagnostic log files to the USB drive for technical support purposes.
- Copy prescriptions from the USB drive to the internal memory and delete from the internal memory.

To access the *Data* menu:

1. From the guidance screen, tap  .
2. From the *Settings* screen, select *Data*. The following screen appears:



Connected Farm Setup

When you enable the Connected Farm feature, this allows the FM-750 display to use the Connected Farm server to automatically and wirelessly send field information (need to find out what type of info) to your home PC.

Initial setup

The Initial Setup wizard takes you through the process of setting up your wireless modem and registering the network.

By default, the Connected Farm feature is set to *Off*. To turn the feature on:

1. Tap **Connected Farm Setup** and then **Connected Farm**.
2. Select *On*. The *Connected Farm Setup* screen appears:



Note – When you turn the Connected Farm option On, tapping Connected Farm Setup takes you directly to the Connected Farm Setup screen.

The following sections describe the menu options available from the *Connected Farm Setup* screen.

Device name

Use the on-screen keypad to give your device a name that you will recognize once you transfer the data to your personal computer.

Modem only setup

Use this option to set up your wireless modem. Once you have connected your modem, the following screen will appear:



In the Wireless Modem Setup screen, you can adjust the following:

- APN/Setup String
- SIM PIN
- Network username: change the username used for network registration.

- Network password: change the password used for network registration.

After you set up your modem, the following screen appears:



Once you receive this message, you can continue with the registration process.

Note – The internal settings for your modem are on the SIM card that your modem uses. For further setup information, contact your SIM card provider.

Network registration

Register your information with the Connected Farm Network. Use the username and password you created when you purchased Connected Farm. For more information contact your local reseller.

Manage Data

The *Manage Data* screen enables you to handle your data via the USB drive or the display's internal memory.

USB

The *USB* screen enables you to:

- Retrieve the field data and FM-750 configuration files from a USB drive and transfer it to the internal memory. The field data includes:
 - Field Boundaries
 - Point, Line and Area features
 - Guidance lines
 - Event data (coverage)
 - Prescriptions
- Send the following data from the internal memory to the USB drive:
 - Autopilot information

- Prescriptions
- Client, farm and field data

Retrieving data from the USB drive

To transfer data from the USB drive to the internal memory:

1. In the *Manage Data* screen, tap USB.
2. Tap *Retrieve Data* and then choose the data that you would like to retrieve.

Sending data to the USB drive

To transfer data from the internal memory to the USB drive:

1. In the *Manage Data* screen, tap USB.
2. Tap *Send Data to USB* and then choose the data that you would like to send:



Note – You cannot send data to a USB drive that is over 90% full.

For more information, see [The USB socket](#), page 28.

Clearing the internal memory

Over time the FM-750 display's internal memory may become full. To avoid this, delete files that you no longer require:

1. In the *Manage Data* screen, tap *Internal* and then *Delete Data*.
2. Select the information that you want to delete and then follow the wizard until the files are deleted.

Note – If a field is currently open it will close prior to the deletion.

System

In this chapter:

- [Introduction](#)
- [Display](#)
- [Advanced](#)
- [EZ-Remote](#)
- [Unlock / Upgrade](#)
- [Status](#)
- [FM-750](#)
- [Recalibrate Touchscreen](#)

This chapter describes how to configure the system settings.

Introduction

The *System* menu enables you to adjust a variety of the FM-750 display settings.

To access the *System* menu:

1. From the guidance screen, tap  .
2. From the *Settings* screen, tap  . The following screen appears:



The following sections describe the various items that are available in the *System* menu.

Display

Use the items in the *Display* screen to adjust the appearance of your FM-750 display.

Units

You can display distances, speeds and areas in either US/Imperial or Metric format. By default, the display uses the US/Imperial format.

The available units for each format are outlined below:

Unit	US / Imperial	Metric
Distance	inches feet miles	centimeters meters kilometers
Speed	miles per hour	kilometers per hour
Area	acres	hectares

Color Scheme

You can adjust your color scheme according to the cab lighting and time of day. For more information, see [Backlight](#), page 124.

This color scheme ...	Is suitable for ...
Day Note – This is the default color scheme.	A brightly lit environment.
Dimmed	Dark and low cab light environments
Red	Dark and low cab light environments

Time Zone

The GPS receiver provides UTC (formerly GMT) time. To display and log times in your local time, set the time zone offset.

Location	Standard Time Offset	Daylight Savings Time Offset
US Eastern Time	-5:00	-4:00
US Central	-6:00	-5:00
US Mountain	-7:00	-6:00
US Pacific	-8:00	-7:00
Australia East	+10:00	-11:00 (excludes QLD)
Australia Central	+9:30	+10:30 (excludes NT)
Australia West	+8:00	+8:00

View

There are three options for the map views:

View	Description
Auto Headland	The view automatically swaps between overhead view (in headlands) and trailing view (on swaths).
Auto Engage	The view automatically swaps between overhead view (not engaged) and trailing view (engaged).
Manual	You must manually change between overhead and trailing view.

Status Popup Transparency

Use this option to control the transparency level of the status popup tab:

At this level of transparency ...	The tab is ...
10	completely solid
1	barely visible

Backlight

You can adjust the brightness of the screen backlight to maximize visibility and reduce glare in different light conditions. For more information, see [Color Scheme, page 123](#).

Touchscreen speaker volume

You can adjust the volume of the speaker according to your preference. Choose from *Loud*, *Quiet* or *Off*.

Lightbar Setup

You can adjust the lightbar settings as follows:

Use this setting ...	To ...
Look Ahead	<p>Allow time for large vehicles to correct offline error:</p> <ul style="list-style-type: none"> For large vehicles that take longer to turn, increase the look ahead time. For 4WD articulated tractors, always set the look ahead time to 0 seconds. <p>Look ahead time applies to LED guidance only and does not affect EZ-Steer performance.</p> <p>Set the look ahead time in seconds.</p>
LED Spacing <i>Note – The LED spacing is the distance represented by one LED.</i>	<p>Adjust the sensitivity of the LEDs. To:</p> <p>increase sensitivity, decrease the LED spacing</p> <p>decrease sensitivity, increase the LED spacing</p>
LED Brightness	Adjust the LED brightness for maximum visibility.
Main Lightbar LED Mode	<p>Select the required LED mode. There are two modes to choose from:</p> <ul style="list-style-type: none"> Chase: Chase the lights to stay online. The lights represent the swath location relative to the vehicle. Pull: Center the lights to stay online. The lights represent the vehicle location relative to the swath.

Advanced

Use the items in the *Advanced* screen to view and adjust advanced system features.



Save/Load Configurations

Once you have set up your lightbar for your current job, you can save the settings to a configuration file. Saving a system configuration can be useful for:

- Quick setup when moving the display between vehicles.
- Quick setup when using the same vehicle but changing the implement or application.
- Tuning the settings for improved performance. Save your improved settings.
- Restoring known good settings if unwanted adjustments have been made.

Radar Output

The FM-750 display can output simulated radar pulses at a pre-defined speed pulse output rate. This can be useful for:

- Replacing the radar/true ground speed sensor for measuring the speed of the vehicle.
- Sending the measured vehicle speed to any other agricultural device that requires speed pulses, such as a yield monitor or variable rate controller.

To use speed pulse output you need a radar sensor cable kit, which includes a pulse amplifier adapter.

Enable Advanced User Config



CAUTION – Do not use the *Enable Advanced User Config* feature unless you have the support of your local reseller. Altering any of the settings for this feature may cause system failure.

NMEA Output

NMEA (National Marine Electronics Association) messages are a standard format that GPS devices use to communicate. The FM-750 display can output NMEA messages to communicate with other NMEA-compatible devices.

In the NMEA Port Parameters screen, specify the following:

Use this setting ...	To ...
NMEA output port	Specify the port that the NMEA device is connected to
Baud Rate	Set the transmit/receive rate of the serial port in bits per second (bps)
Data Parity	Select how the parity bit is added to the data transfer

Note – For the FM-750 display to communicate with another device, the Port Parameters on the display must match those of the device.

In the *Message Selection* screen, select from the list of available NMEA messages:

Message	Description
GGA	Position and fix related data
VTG	Speed and heading
GSA	Position fix mode, satellites used, and the dilution of precision (DOPs)
GLL	Position and status
RMC	Status, position, speed over ground (SOG), date, and magnetic variation of the position
ZDA	Date and time
GSV	Satellite information

EZ-Remote

The EZ-Remote option will only appear in the *System* menu if you have an EZ-Remote joystick installed. For more information, see the *EZ-Remote Joystick Quick Reference Card*.

Use the *EZ-Remote* screen to:

- assign functions to buttons 1-4 on the EZ-Remote joystick
- adjust the LED brightness of the buttons

- review your button assignments.



EZ-Remote Keypad Assignment Wizard

1. On the FM-750 display, tap the first EZ-Remote joystick button that you would like to program.
2. In the *Choose a Function* screen, tap the function you would like to assign to the joystick button. See [Using the EZ-Remote joystick, page 40](#).
3. In the *Finished* screen, select either:
 - **Choose another button** to repeat Step 1 and Step 2.
 - **Complete this wizard** to exit the wizard.

EZ-Remote LED Brightness

Use this screen to adjust the brightness of the LED buttons on the joystick. Enter a number between 0-100.

EZ-Remote Keypad Assignments

The *EZ-Remote Keypad Assignments* screen shows the functions that have been assigned to the four programmable buttons,

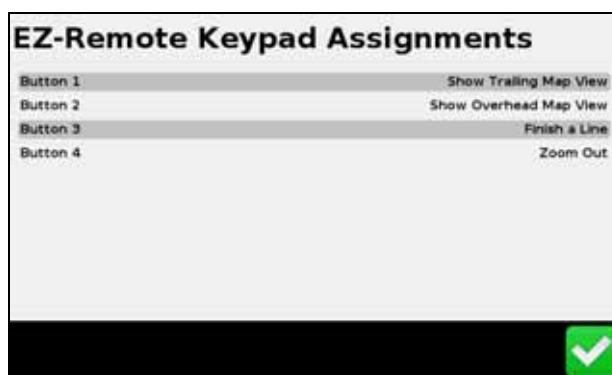

Unlock / Upgrade

Use the *Unlock/Upgrade* screen to:

- Upgrade your FM-750 display to a newer firmware version.
- Unlock features such as Field-IQ crop input control system.

Upgrading your display

1. Copy the new firmware file to your office computer.
2. Connect the FM-750 display USB memory stick to your office computer.
3. Unzip the firmware file and then save it to the root folder of the USB memory stick.
4. Insert the USB memory stick into the USB socket of the display.
5. In the Unlock/Upgrade screen, tap **Firmware Upgrade Wizard**.
6. Select the file that you want to upload, and then tap . The firmware begins to load.

Once the new firmware has successfully loaded, the display automatically restarts. **Do not** disconnect the power from the display while it is rebooting.

Unlocking features

Note – To unlock features, you must have an unlock code. To obtain an unlock code, contact your local reseller.

1. In the Unlock/Upgrade screen, tap **Password Upgrade**.
2. Enter the unlock password. Note that passwords are case sensitive.

Once the password is successfully entered, the display automatically restarts. **Do not** disconnect the power from the display while it is rebooting.

Status

Use the *Status* screen to view the current status of the system. The items that appear in the *Status* screen vary according to the features that you use.

Select this item ...	To view ..
Region protect	The GPS signal region you are currently in and whether it is locked or unlocked. If your region is locked, contact your local reseller.
Language Pack status	The language packs that have been installed on the display.

Select this item ...	To view ..
LB25 remote lightbar status	The following information for the lightbar: <ul style="list-style-type: none"> • Status: <i>Connected</i> or <i>Disconnected</i> • Serial number • Firmware version
EZ-Remote status	The following information for the EZ-Remote: <ul style="list-style-type: none"> • Status: <i>Connected</i> or <i>Disconnected</i> • Serial number • Firmware version
System status	The current time and date ID: FM-750 The following data about your FM-750 display: <ul style="list-style-type: none"> • Version and Version date • Serial number • Part number • Hardware Revision System voltage Temperature Storage: This is the number of hours of coverage logging remaining before the internal memory is full. Operational hours: This is the number of hours that the FM has been operating.
Upgrade options	The status of optional features and extensions
Fault history	Those faults that have occurred recently (they may not be currently active).

FM-750

The *FM-750* screen displays two options:

- About the Display
This screen displays information about your FM-750 display, including the current version and the serial number.
- Restore Defaults
Restore the display defaults to clear all of your current settings. Note that if you choose to restore the default settings, your display and lightbar will restart.

Recalibrate Touchscreen

The first time you power on the display, you must calibrate the touchscreen. See [Power up, page 26](#).

If the current calibration does not read your selections accurately, use the *Recalibrate Touchscreen* option to adjust the responsiveness of the touchscreen.

Alternatively, do the following:

1. Power off the display and then power it on.
2. Wait until the status bar at the bottom of the second startup screen is more than half full:



3. Press **both** brightness control buttons at the same time:



4. Hold the two buttons down until the display beeps.