

**2W ZENER DIODES**

**FEATURES**

- VOLTAGE RANGE : 5.1 V to 200 V
- HERMETICALLY SEALED PLASTIC CASE : F126 PACKAGE
- HIGH SURGE CAPABILITY : 55 W (10 ms) .

**DESCRIPTION**

2 W silicon Zener diodes.

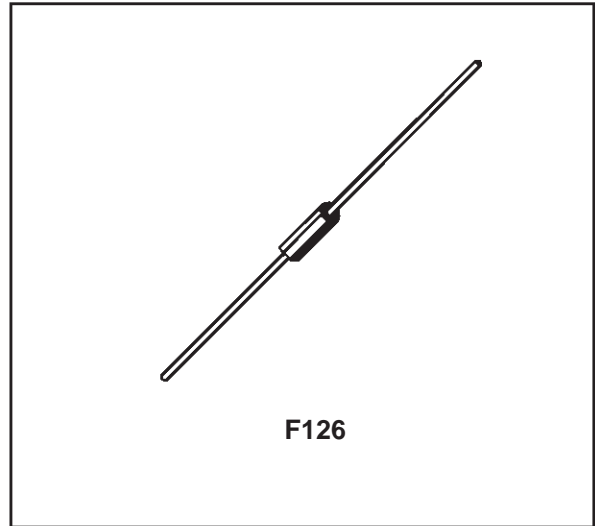

**ABSOLUTE RATINGS** (T<sub>amb</sub> = 25°C)

Symbol	Parameter	Value	Unit
P	Power dissipation on infinite heatsink T <sub>amb</sub> = 55°C	2	W
T <sub>stg</sub> T <sub>j</sub>	Storage temperature range Maximum junction temperature	- 65 to + 175 175	°C °C
T <sub>L</sub>	Maximum lead temperature for soldering during 10s at 5mm from case	230	°C

**THERMAL RESISTANCES**

Symbol	Parameter	Value	Unit
R <sub>th</sub> (j-l)	Junction to lead	60	°C/W
R <sub>th</sub> (j-a)	Junction to ambient on printed circuit on recommended pad layout	100	°C/W

## BZV47C5V1 / BZV47C200

### ELECTRICAL CHARACTERISTIC (Tamb= 25°C)

TYPES	V <sub>ZT</sub> @ I <sub>ZT</sub>		r <sub>ZK</sub> / I <sub>ZK</sub>	I <sub>ZT</sub>	∞V <sub>Z</sub>	I <sub>R</sub> / V <sub>R</sub>	V <sub>R</sub>	I <sub>ZM</sub>	I <sub>ZSM</sub>
	min. (1)	max. (1)	max.	(1)	typ.	max.		T <sub>amb</sub> =55°C (2)	(3)
	V	V	Ω	mA	10 <sup>-4</sup> /°C	μA	V	mA	A
BZV47C5V1	4.8	5.4	5	100	1	5	1	370	7.8
BZV47C5V6	5.2	6	2	100	2.5	5	1	330	7.1
BZV47C6V2	5.8	6.6	2	100	3.2	5	1	300	6.4
BZV47C7V5	7	7.9	2	100	4.5	5	2	250	5.4
BZV47C10	9.4	10.6	4	50	5.5	5	7.6	185	4
BZV47C12	11.4	12.7	7	50	6.5	1	9.1	155	3.3
BZV47C15	13.8	15.6	10	50	7	1	11.4	130	2.7
BZV47C18	16.8	19.1	15	25	7.5	0.5	13.7	105	2.2
BZV47C20	18.8	21.2	15	25	7.5	0.5	15.2	94	2
BZV47C22	20.8	23.3	15	25	8	0.5	16.7	86	1.8
BZV47C24	22.8	25.6	15	25	8	0.5	18.2	78	1.7
BZV47C27	25.1	28.9	15	25	8.5	0.5	20.5	69	1.5
BZV47C30	28	32	15	25	8.5	0.5	22.8	62	1.3
BZV47C36	34	38	40	10	8.5	0.5	27.4	52	1.1
BZV47C39	37	41	40	10	9	0.5	29.6	48	1
BZV47C47	44	50	45	10	9	0.5	35.7	40	0.85
BZV47C68	64	72	80	10	9	0.5	51.7	27	0.59
BZV47C100	94	106	200	5	9	0.5	76	18	0.4
BZV47C150	138	156	300	5	9.5	0.5	114	12.8	0.27
BZV47C200	188	212	350	5	9.5	0.5	152	9.4	0.20

Note 1 : Pulse test : tp ≤ 50ms

Note 2 : On infinite heatsink : L = 10mm

Note 3 : rectangular waveform (tp = 10ms)

Forward voltage drop : VF ≤ 1.2 V (Tamb = 25°C, IF = 500mA)

**Fig. 1** : Power dissipation versus ambient temperature.

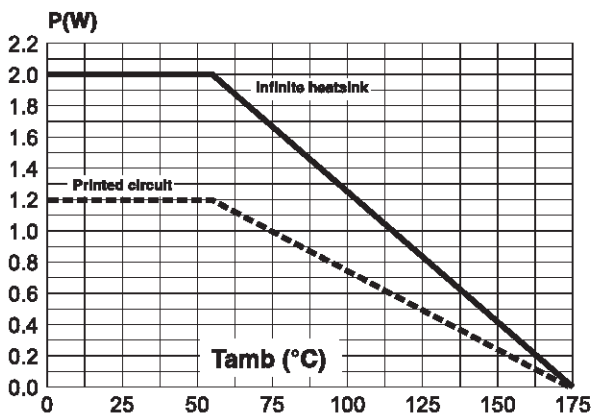

**Fig. 2** : Thermal resistance versus lead length.

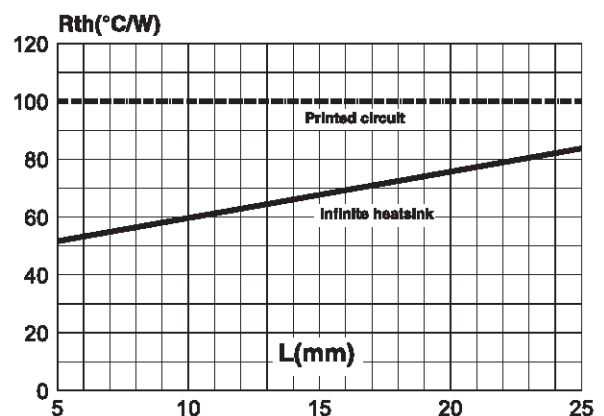

**Fig. 3 :** Relative variation of thermal impedance junction to ambient versus pulse duration (PC board FR4,  $L_{leads} = 10mm$ ).

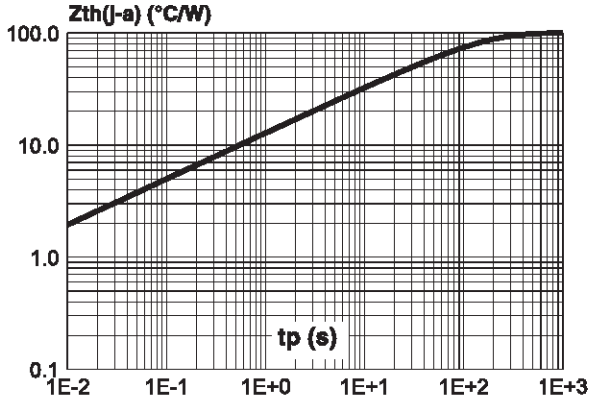

**Fig. 5 :** Peak forward current versus peak forward voltage drop (typical values).

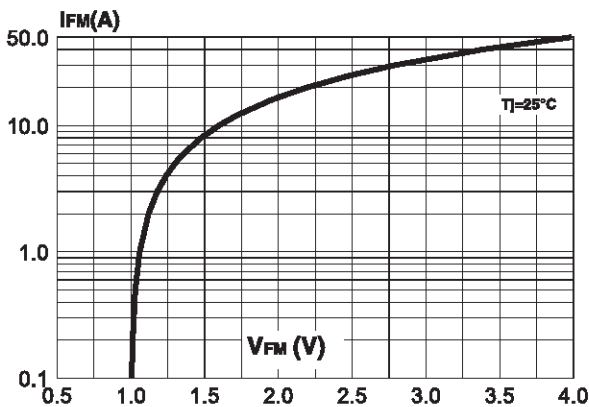

**Fig. 7 :** Differential resistance versus regulation voltage (typical values).

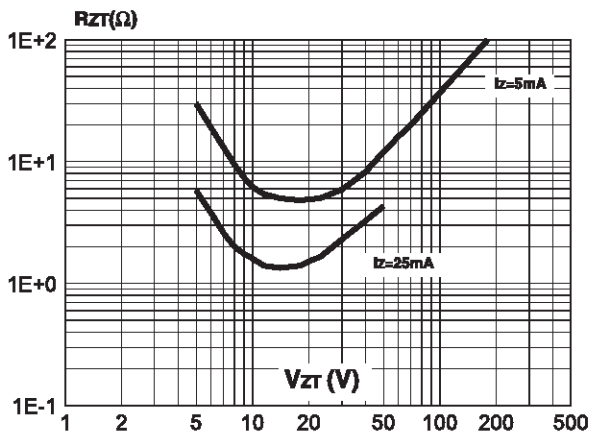

**Fig. 4 :** Junction capacitance versus reverse voltage applied (typical values).

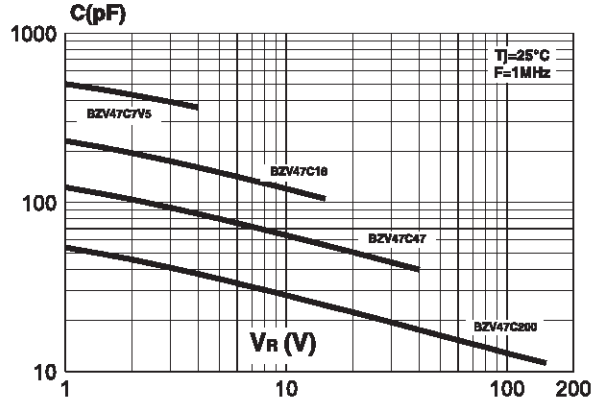

**Fig. 6 :** Leakage current versus regulation voltage (typical values).

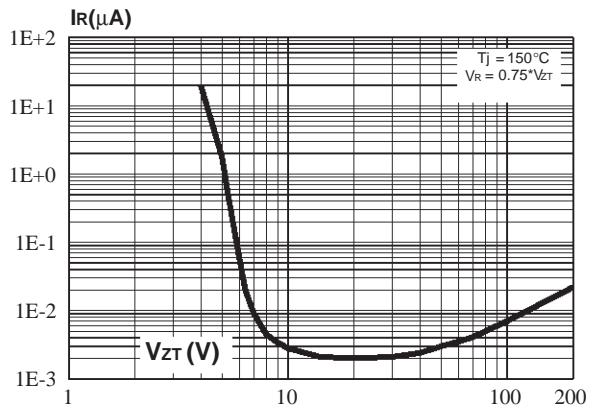

**Fig. 8 :** Peak pulse power versus pulse duration (rectangular waveform, maximum values).

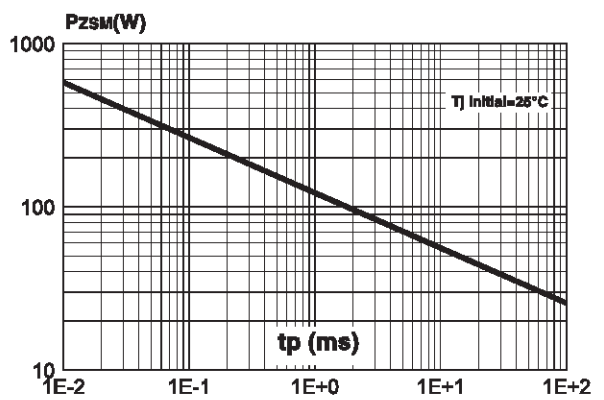

**BZV47C5V1 / BZV47C200**

**MARKING** : Logo, Date Code, Type Code, Cathode Band (for unidirectional types only).

**ORDER CODE**

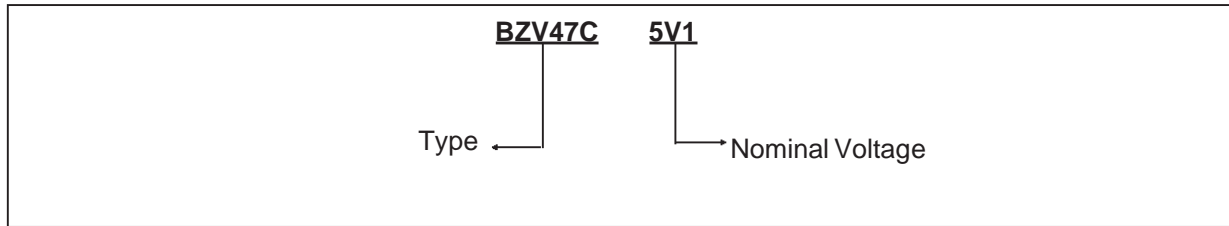

**PACKAGE MECHANICAL DATA**

F126 (Plastic)

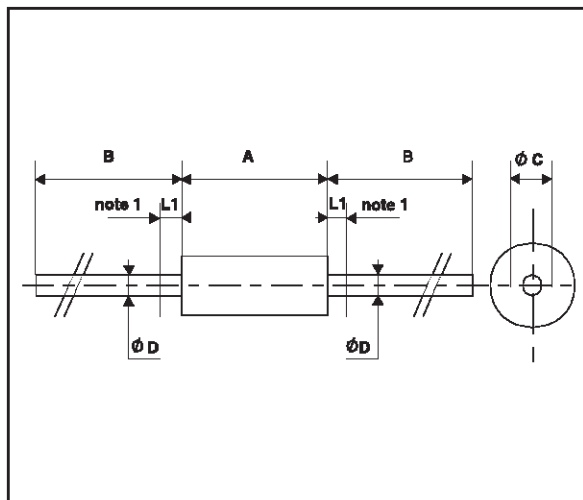

REF.	DIMENSIONS					
	Millimeters			Inches		
	Min.	Typ.	Max.	Min.	Typ.	Max.
A	6.05	6.20	6.35	0.238	0.244	0.250
B	26		31	1.024		1.220
ØC	2.95	3.00	3.05	0.116	0.118	0.120
ØD	0.76	0.81	0.86	0.030	0.032	0.034
L1			1.27			0.050
Note 1 : The lead is not controlled within zone L1.						

**Packaging** : standard packaging is in tape and reel.

**Weight** = 0.40 g.

Information furnished is believed to be accurate and reliable. However, SGS-THOMSON Microelectronics assumes no responsibility for the consequences of use of such information nor for any infringement of patents or other rights of third parties which may result from its use. No license is granted by implication or otherwise under any patent or patent rights of SGS-THOMSON Microelectronics. Specifications mentioned in this publication are subject to change without notice. This publication supersedes and replaces all information previously supplied. SGS-THOMSON Microelectronics products are not authorized for use as critical components in life support devices or systems without express written approval of SGS-THOMSON Microelectronics.

© 1998 SGS-THOMSON Microelectronics - Printed in Italy - All rights reserved.

SGS-THOMSON Microelectronics GROUP OF COMPANIES  
 Australia - Brazil - Canada - China - France - Germany - Italy - Japan - Korea - Malaysia - Malta - Morocco  
 The Netherlands - Singapore - Spain - Sweden - Switzerland - Taiwan - Thailand - United Kingdom - U.S.A.