

ABB 5STP18T1800 Control Thyristor datasheet

<http://www.manuallib.com/abb/5stp18t1800-control-thyristor-datasheet.html>

Properties

High operational capability

Possibility of serial and parallel connection

ManualLib.com collects and classifies the global product instruction manuals to help users access anytime and anywhere, helping users make better use of products.

<http://www.manuallib.com>



5STP 18T1800

Old part no. T 918C-1770-18

Phase Control Thyristor

Properties

- High operational capability
- Possibility of serial and parallel connection

Applications

- Controlled rectifiers
- AC drives

Key Parameters

V_{DRM}, V_{RRM}	= 1 800	V
I_{TAVm}	= 1 870	A
I_{TSM}	= 26 250	A
V_{TO}	= 0.965	V
r_T	= 0.170	mΩ

Types

	V_{RRM}, V_{DRM}
5STP 18T1800	1 800 V
Conditions:	$T_j = -40 \div 125 \text{ }^\circ\text{C}$, half sine waveform, $f = 50 \text{ Hz}$

Mechanical Data

F_m	Mounting force	22 ± 2 kN
m	Weight	0.40 kg
D_s	Surface creepage distance	18 mm
D_a	Air strike distance	9 mm

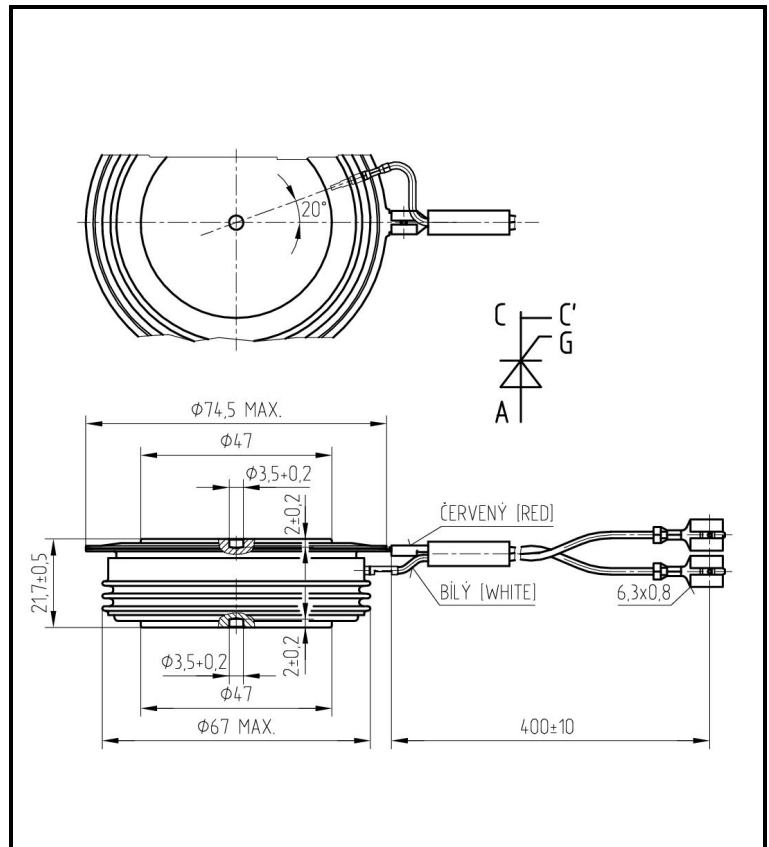

Fig. 1 Case



ABB s.r.o.

Novodvorska 1768/138a, 142 21 Praha 4, Czech Republic

tel.: +420 261 306 250, <http://www.abb.com/semiconductors>

Maximum Ratings		Maximum Limits	Unit
V_{RRM} V_{DRM}	Repetitive peak reverse and off-state voltage $T_j = -40 \div 125 \text{ }^\circ\text{C}$	1 800	V
I_{TRMS}	RMS on-state current $T_c = 70 \text{ }^\circ\text{C}$, half sine waveform, $f = 50 \text{ Hz}$	2 937	A
I_{TAVm}	Average on-state current $T_c = 70 \text{ }^\circ\text{C}$, half sine waveform, $f = 50 \text{ Hz}$	1 870	A
I_{TSM}	Peak non-repetitive surge half sine pulse, $V_R = 0 \text{ V}$	$t_p = 10 \text{ ms}$ 26 250 $t_p = 8.3 \text{ ms}$ 28 000	A
I^2t	Limiting load integral half sine pulse, $V_R = 0 \text{ V}$	$t_p = 10 \text{ ms}$ 3 445 313 $t_p = 8.3 \text{ ms}$ 3 250 000	A²s
$(di_T/dt)_{cr}$	Critical rate of rise of on-state current $I_T = I_{TAVm}$, half sine waveform, $f = 50 \text{ Hz}$, $V_D = 2/3 V_{DRM}$, $t_r = 0.3 \text{ } \mu\text{s}$, $I_{GT} = 2 \text{ A}$	200	A/μs
$(dv_D/dt)_{cr}$	Critical rate of rise of off-state voltage $V_D = 2/3 V_{DRM}$	1 000	V/μs
P_{GAVm}	Maximum average gate power losses	3	W
I_{FGM}	Peak gate current	10	A
V_{FGM}	Peak gate voltage	12	V
V_{RGM}	Reverse peak gate voltage	10	V
$T_{jmin} - T_{jmax}$	Operating temperature range	-40 \div 125	$^\circ\text{C}$
$T_{stgmin} - T_{stgmax}$	Storage temperature range	-40 \div 125	$^\circ\text{C}$

Unless otherwise specified $T_j = 125 \text{ }^\circ\text{C}$

ABB s.r.o., Novodvorska 1768/138a, 142 21 Praha 4, Czech Republic

ABB s.r.o. reserves the right to change the data contained herein at any time without notice

TS - T/109/04a Jul-11

2 of 5

Characteristics		Value			Unit
		min.	typ.	max.	
V_{TM}	Maximum peak on-state voltage $I_{TM} = 2\ 000\ A$			1.300	V
V_{T0}	Threshold voltage			0.965	V
r_T	Slope resistance $I_{T1} = 2\ 289\ A, I_{T2} = 6\ 866\ A$			0.170	mΩ
I_{DM}	Peak off-state current $V_D = V_{DRM}$			80	mA
I_{RM}	Peak reverse current $V_R = V_{RRM}$			80	mA
t_{gd}	Delay time $T_j = 25\ ^\circ C, V_D = 0.4\ V_{DRM}, I_{TM} = I_{TAVm},$ $t_r = 0.3\ \mu s, I_{GT} = 2\ A$			2	μs
t_q	Turn-off time $I_T = 2\ 000\ A, di_T/dt = 12.5\ A/\mu s,$ $V_D = 2/3\ V_{DRM}, dv_D/dt = 50\ V/\mu s$		150		μs
Q_{rr}	Recovery charge <i>the same conditions as at t_q</i>		2 200		μC
I_H	Holding current	$T_j = 25\ ^\circ C$ $T_j = 125\ ^\circ C$		170 90	mA
I_L	Latching current	$T_j = 25\ ^\circ C$ $T_j = 125\ ^\circ C$		450 350	mA
V_{GT}	Gate trigger voltage $V_D = 12\ V, I_T = 4\ A$	$T_j = -40\ ^\circ C$ $T_j = 25\ ^\circ C$ $T_j = 125\ ^\circ C$	0.25	4 3 2	V
I_{GT}	Gate trigger current $V_D = 12\ V, I_T = 4\ A$	$T_j = -40\ ^\circ C$ $T_j = 25\ ^\circ C$ $T_j = 125\ ^\circ C$	10	500 250 150	mA

Unless otherwise specified $T_j = 125\ ^\circ C$

Thermal Parameters		Value	Unit
R_{thjc}	Thermal resistance junction to case <i>double side cooling</i>	15.5	K/kW
	<i>anode side cooling</i>	25.0	
	<i>cathode side cooling</i>	45.0	
R_{thch}	Thermal resistance case to heatsink <i>double side cooling</i>	4.0	K/kW
	<i>single side cooling</i>	8.0	

ABB s.r.o., Novodvorska 1768/138a, 142 21 Praha 4, Czech Republic

ABB s.r.o. reserves the right to change the data contained herein at any time without notice

Transient Thermal Impedance

Analytical function for transient thermal impedance

$$Z_{thjc} = \sum_{i=1}^4 R_i (1 - \exp(-t / \tau_i))$$

Conditions:

$F_m = 22 \pm 2$ kN, Double side cooled

Correction for periodic waveforms

- 180° sine: add 1.3 K/kW
- 180° rectangular: add 1.8 K/kW
- 120° rectangular: add 3.0 K/kW
- 60° rectangular: add 5.1 K/kW

<i>i</i>	1	2	3	4
τ_i (s)	0.41773	0.07323	0.00752	0.00214
R_i (K/kW)	9.311	4.504	1.014	0.675

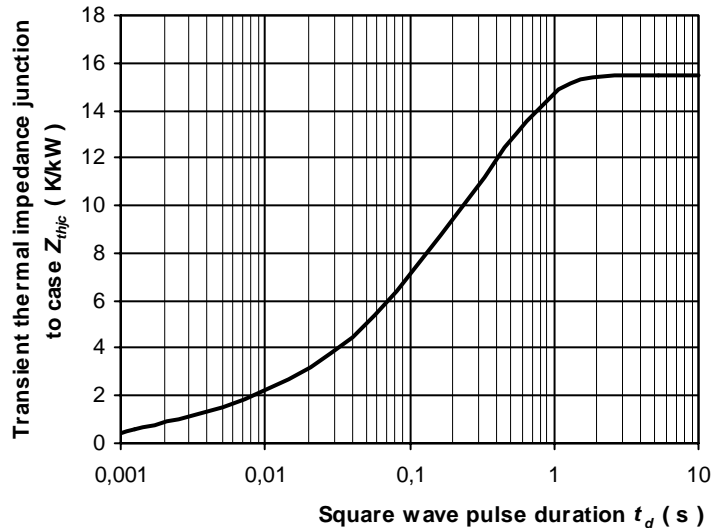

Fig. 2 Dependence transient thermal impedance junction to case on square pulse

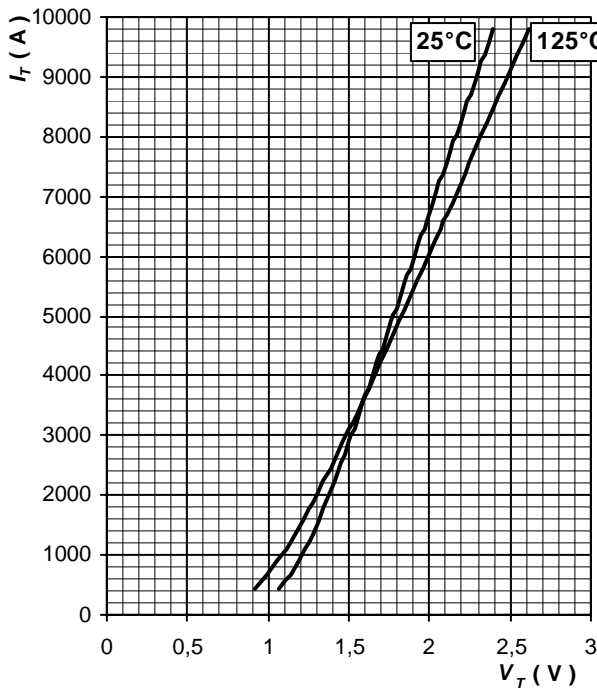

Fig. 3 Maximum on-state characteristics

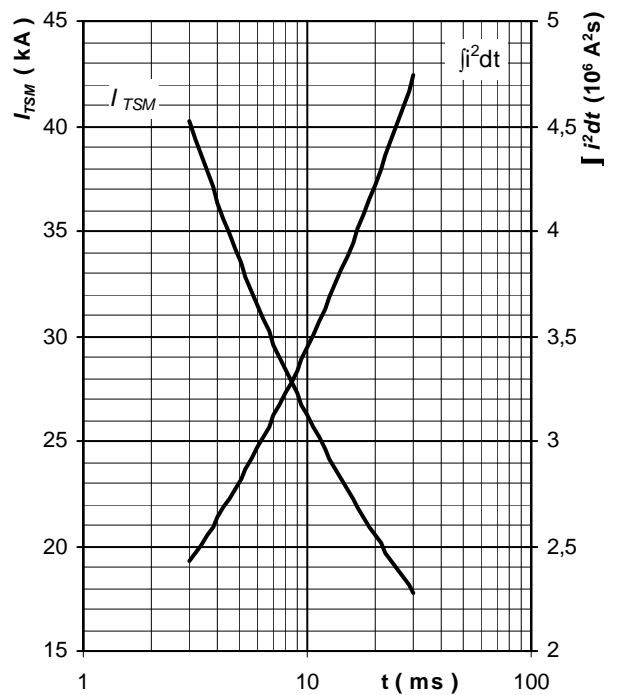

Fig. 4 Surge on-state current vs. pulse length, half sine wave, single pulse, $V_R = 0$ V, $T_j = T_{jmax}$

ABB s.r.o., Novodvorska 1768/138a, 142 21 Praha 4, Czech Republic

ABB s.r.o. reserves the right to change the data contained herein at any time without notice

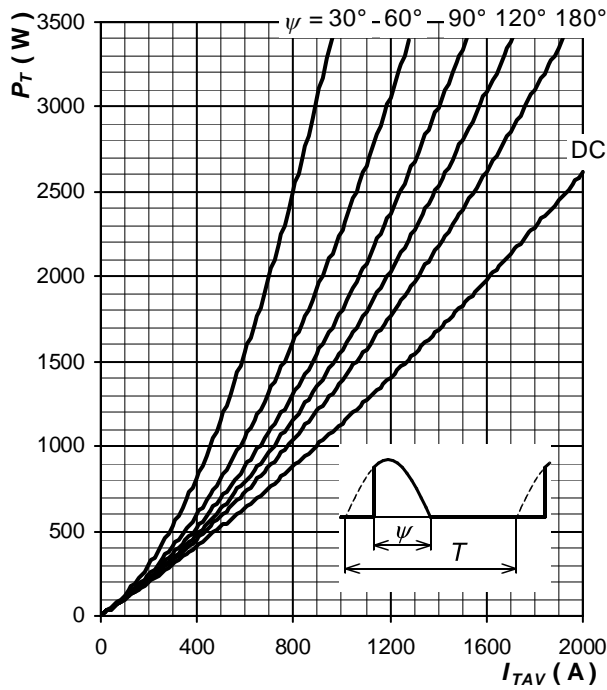

Fig. 5 On-state power loss vs. average on-state current, sine waveform, $f = 50 \text{ Hz}$, $T = 1/f$

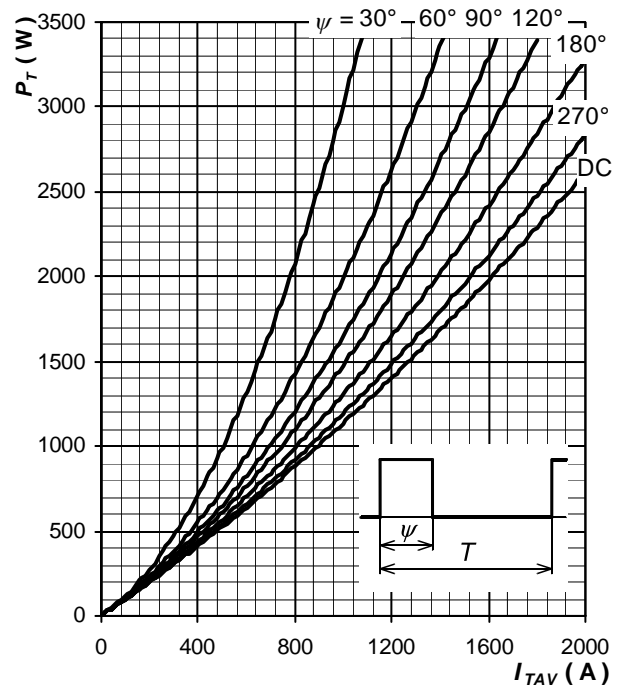

Fig. 6 On-state power loss vs. average on-state current, square waveform, $f = 50 \text{ Hz}$, $T = 1/f$

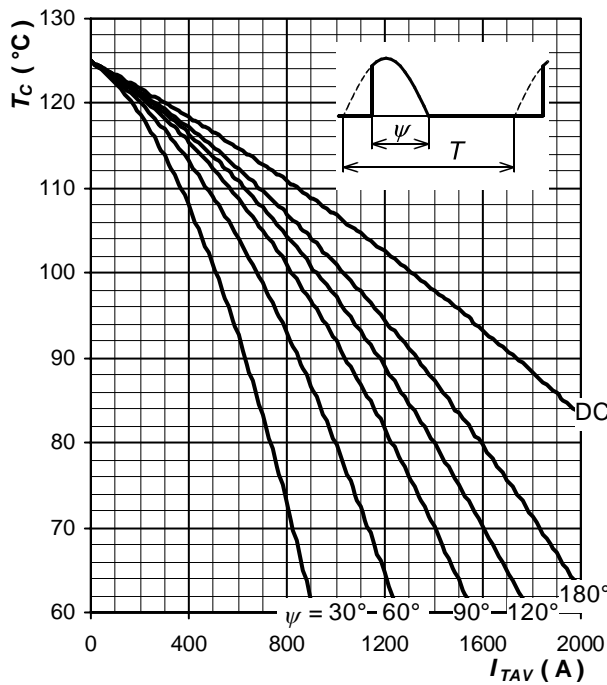

Fig. 7 Max. case temperature vs. aver. on-state current, sine waveform, $f = 50 \text{ Hz}$, $T = 1/f$

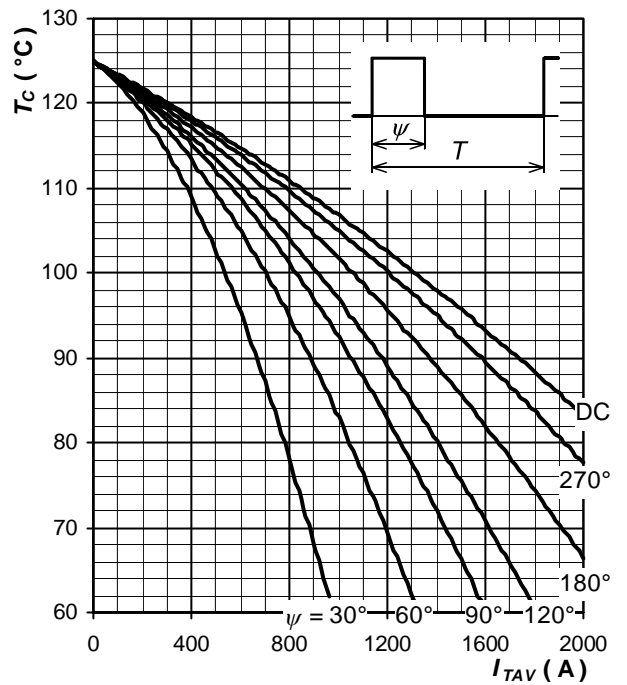

Fig. 8 Max. case temperature vs. aver. on-state current, square waveform, $f = 50 \text{ Hz}$, $T = 1/f$

Notes:

ABB s.r.o., Novodvorska 1768/138a, 142 21 Praha 4, Czech Republic

ABB s.r.o. reserves the right to change the data contained herein at any time without notice
 TS - T/109/04a Jul-11