

# ABB 5STP09D2201 Control Thyristor datasheet

<http://www.manuallib.com/abb/5stp09d2201-control-thyristor-datasheet.html>

## Properties

High operational capability

Possibility of serial and parallel connection

ManualLib.com collects and classifies the global product instruction manuals to help users access anytime and anywhere, helping users make better use of products.

<http://www.manuallib.com>



# 5STP 09D2201

Old part no. TV 907-860-22

## Phase Control Thyristor

### Properties

- High operational capability
- Possibility of serial and parallel connection

### Applications

- Controlled rectifiers
- AC drives

### Key Parameters

$V_{DRM}, V_{RRM}$	= 2 200	V
$I_{TAVm}$	= 863	A
$I_{TSM}$	= 12 000	A
$V_{TO}$	= 0.976	V
$r_T$	= 0.414	mΩ

### Types

	$V_{RRM}, V_{DRM}$
<b>5STP 09D2201</b>	<b>2 200 V</b>
Conditions:	$T_j = -40 \div 125 \text{ }^\circ\text{C}$ , half sine waveform, $f = 50 \text{ Hz}$

### Mechanical Data

$F_m$	Mounting force	10 ± 2 kN
$m$	Weight	0.26 kg
$D_s$	Surface creepage distance	25 mm
$D_a$	Air strike distance	14 mm

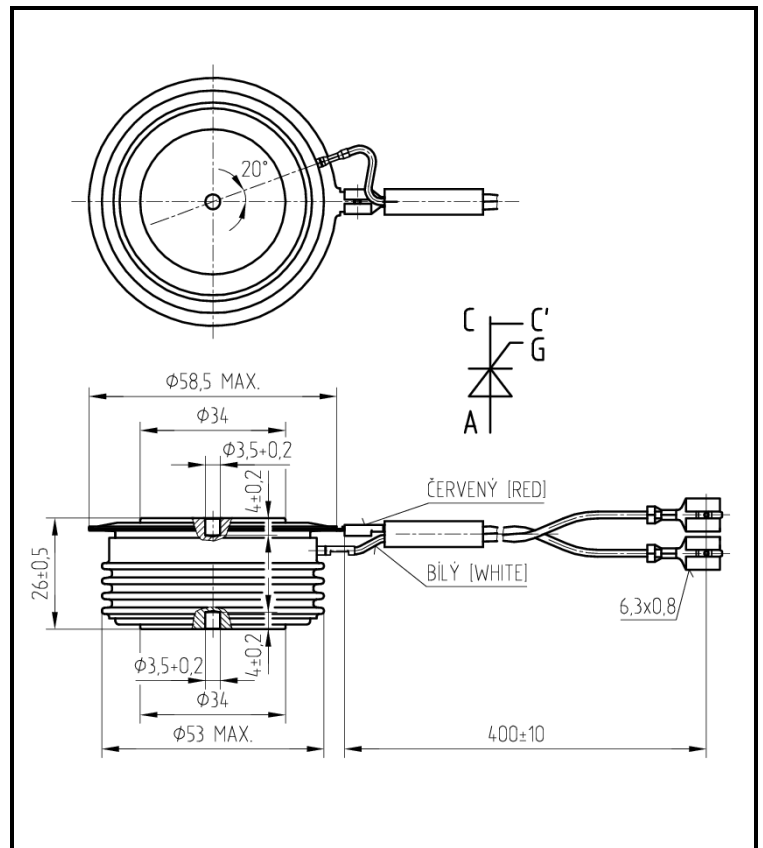

Fig. 1 Case



ABB s.r.o.

Novodvorska 1768/138a, 142 21 Praha 4, Czech Republic

tel.: +420 261 306 250, <http://www.abb.com/semiconductors>

<b>Maximum Ratings</b>		<b>Maximum Limits</b>	<b>Unit</b>
$V_{RRM}$ $V_{DRM}$	<b>Repetitive peak reverse and off-state voltage</b> $T_j = -40 \div 125 \text{ }^\circ\text{C}$	<b>2 200</b>	<b>V</b>
$I_{TRMS}$	<b>RMS on-state current</b> $T_c = 70 \text{ }^\circ\text{C}$ , half sine waveform, $f = 50 \text{ Hz}$	<b>1 356</b>	<b>A</b>
$I_{TAVm}$	<b>Average on-state current</b> $T_c = 70 \text{ }^\circ\text{C}$ , half sine waveform, $f = 50 \text{ Hz}$	<b>863</b>	<b>A</b>
$I_{TSM}$	<b>Peak non-repetitive surge</b> half sine pulse, $V_R = 0 \text{ V}$	$t_p = 10 \text{ ms}$ <b>12 000</b> $t_p = 8.3 \text{ ms}$ <b>12 800</b>	<b>A</b>
$I^2t$	<b>Limiting load integral</b> half sine pulse, $V_R = 0 \text{ V}$	$t_p = 10 \text{ ms}$ <b>720 000</b> $t_p = 8.3 \text{ ms}$ <b>680 000</b>	<b>A<sup>2</sup>s</b>
$(di_T/dt)_{cr}$	<b>Critical rate of rise of on-state current</b> $I_T = I_{TAVm}$ , half sine waveform, $f = 50 \text{ Hz}$ , $V_D = 2/3 V_{DRM}$ , $t_r = 0.3 \text{ } \mu\text{s}$ , $I_{GT} = 2 \text{ A}$	<b>200</b>	<b>A/<math>\mu\text{s}</math></b>
$(dv_D/dt)_{cr}$	<b>Critical rate of rise of off-state voltage</b> $V_D = 2/3 V_{DRM}$	<b>1 000</b>	<b>V/<math>\mu\text{s}</math></b>
$P_{GAVm}$	<b>Maximum average gate power losses</b>	<b>3</b>	<b>W</b>
$I_{FGM}$	<b>Peak gate current</b>	<b>10</b>	<b>A</b>
$V_{FGM}$	<b>Peak gate voltage</b>	<b>12</b>	<b>V</b>
$V_{RGM}$	<b>Reverse peak gate voltage</b>	<b>10</b>	<b>V</b>
$T_{jmin} - T_{jmax}$	<b>Operating temperature range</b>	<b>-40 <math>\div</math> 125</b>	<b><math>^\circ\text{C}</math></b>
$T_{stgmin} - T_{stgmax}$	<b>Storage temperature range</b>	<b>-40 <math>\div</math> 125</b>	<b><math>^\circ\text{C}</math></b>

Unless otherwise specified  $T_j = 125 \text{ }^\circ\text{C}$

ABB s.r.o., Novodvorska 1768/138a, 142 21 Praha 4, Czech Republic

ABB s.r.o. reserves the right to change the data contained herein at any time without notice

TS - TV/074/02b Jul-11

2 of 5

Characteristics		Value			Unit
		min.	typ.	max.	
$V_{TM}$	<b>Maximum peak on-state voltage</b> $I_{TM} = 1\ 500\ A$			1.600	V
$V_{T0}$	<b>Threshold voltage</b>			0.976	V
$r_T$	<b>Slope resistance</b> $I_{T1} = 1\ 089\ A, I_{T2} = 3\ 266\ A$			0.414	mΩ
$I_{DM}$	<b>Peak off-state current</b> $V_D = V_{DRM}$			70	mA
$I_{RM}$	<b>Peak reverse current</b> $V_R = V_{RRM}$			70	mA
$t_{gd}$	<b>Delay time</b> $T_j = 25\ ^\circ C, V_D = 0.4\ V_{DRM}, I_{TM} = I_{TAVm},$ $t_r = 0.3\ \mu s, I_{GT} = 2\ A$			2	μs
$t_q$	<b>Turn-off time</b> $I_T = 1500\ A, di_T/dt = 12.5\ A/\mu s,$ $V_D = 2/3\ V_{DRM}, dv_D/dt = 50\ V/\mu s$		200		μs
$Q_{rr}$	<b>Recovery charge</b> <i>the same conditions as at <math>t_q</math></i>		1 600		μC
$I_H$	<b>Holding current</b>	$T_j = 25\ ^\circ C$ $T_j = 125\ ^\circ C$	170 90		mA
$I_L$	<b>Latching current</b>	$T_j = 25\ ^\circ C$ $T_j = 125\ ^\circ C$	450 350		mA
$V_{GT}$	<b>Gate trigger voltage</b> $V_D = 12\ V, I_T = 4\ A$	$T_j = -40\ ^\circ C$ $T_j = 25\ ^\circ C$ $T_j = 125\ ^\circ C$	0.25	4 3 2	V
$I_{GT}$	<b>Gate trigger current</b> $V_D = 12\ V, I_T = 4\ A$	$T_j = -40\ ^\circ C$ $T_j = 25\ ^\circ C$ $T_j = 125\ ^\circ C$	10	500 250 150	mA

Unless otherwise specified  $T_j = 125\ ^\circ C$

Thermal Parameters		Value	Unit
$R_{thjc}$	<b>Thermal resistance junction to case</b> <i>double side cooling</i>	32.0	K/kW
	<i>anode side cooling</i>	52.0	
	<i>cathode side cooling</i>	83.0	
$R_{thch}$	<b>Thermal resistance case to heatsink</b> <i>double side cooling</i>	10.0	K/kW
	<i>single side cooling</i>	20.0	

ABB s.r.o., Novodvorska 1768/138a, 142 21 Praha 4, Czech Republic

ABB s.r.o. reserves the right to change the data contained herein at any time without notice  
TS - TV/074/02b Jul-11

3 of 5

**Transient Thermal Impedance**

Analytical function for transient thermal impedance

$$Z_{thjc} = \sum_{i=1}^5 R_i (1 - \exp(-t/\tau_i))$$

Conditions:

$F_m = 10 \pm 2$  kN, Double side cooled

**Correction for periodic waveforms**

- 180° sine: add 2.3 K/kW
- 180° rectangular: add 3.1 K/kW
- 120° rectangular: add 5.2 K/kW
- 60° rectangular: add 8.7 K/kW

<i>i</i>	1	2	3	4	5
$\tau_i$ (s)	0.4857	0.2162	0.0762	0.0043	0.0006
$R_i$ (K/ W)	13.07	8.03	8.20	2.57	0.13

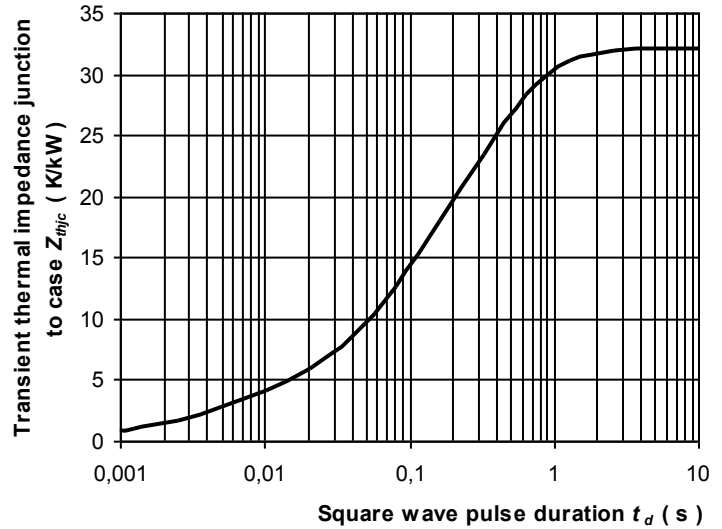

Fig. 2 Dependence transient thermal impedance junction to case on square pulse

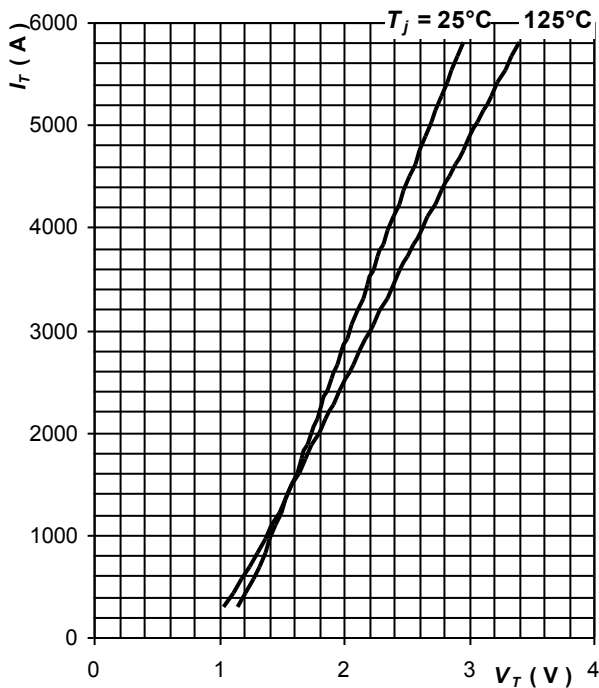

Fig. 3 Maximum on-state characteristics

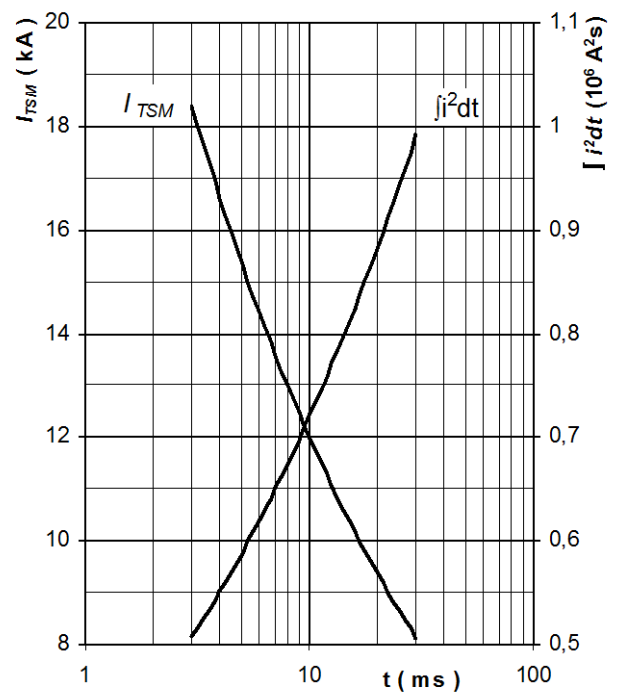

Fig. 4 Surge on-state current vs. pulse length, half sine wave, single pulse,  $V_R = 0$  V,  $T_j = T_{jmax}$

ABB s.r.o., Novodvorska 1768/138a, 142 21 Praha 4, Czech Republic

ABB s.r.o. reserves the right to change the data contained herein at any time without notice

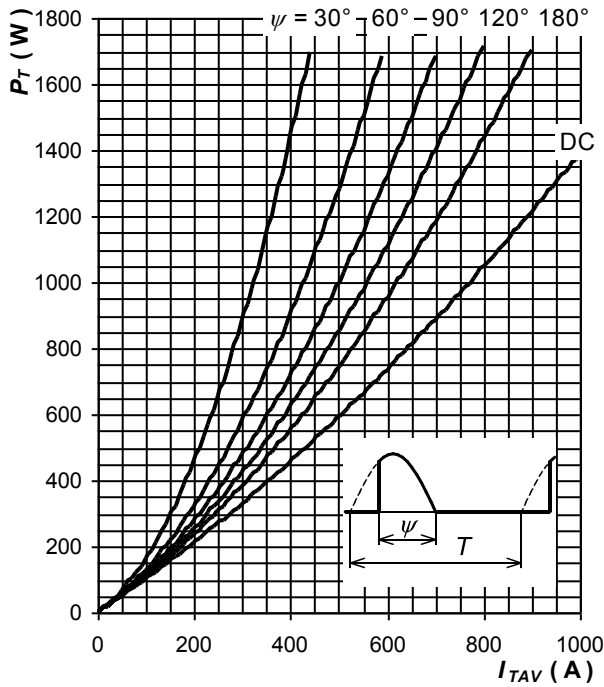

Fig. 5 On-state power loss vs. average on-state current, sine waveform,  $f = 50 \text{ Hz}$ ,  $T = 1/f$

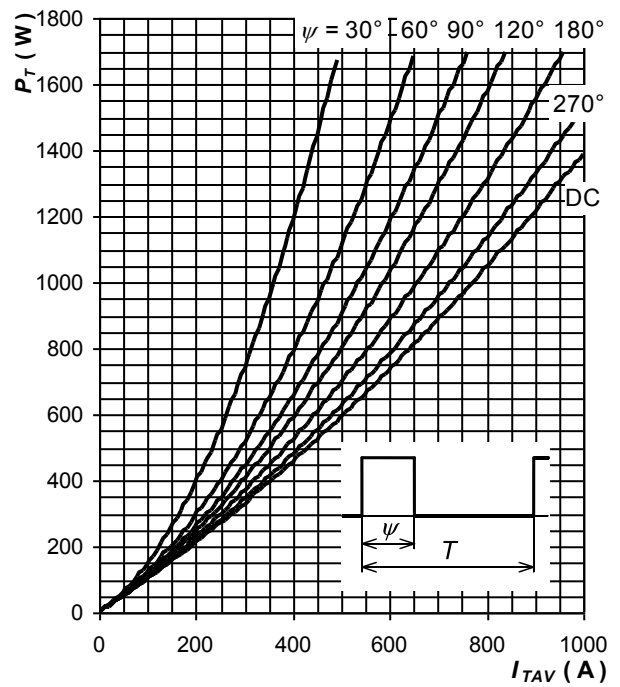

Fig. 6 On-state power loss vs. average on-state current, square waveform,  $f = 50 \text{ Hz}$ ,  $T = 1/f$

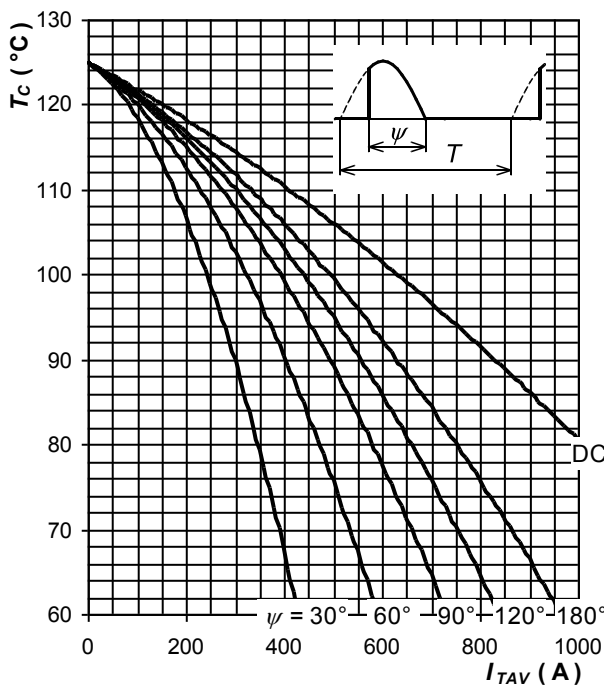

Fig. 7 Max. case temperature vs. aver. on-state current, sine waveform,  $f = 50 \text{ Hz}$ ,  $T = 1/f$

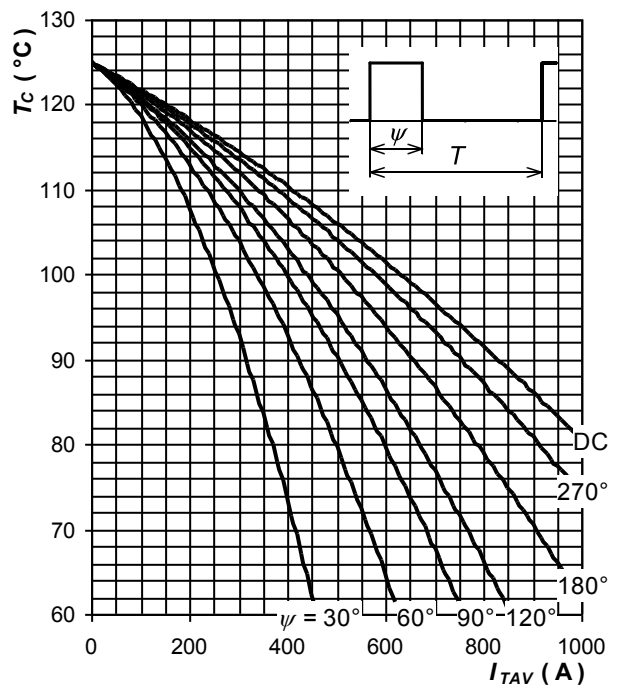

Fig. 8 Max. case temperature vs. aver. on-state current, square waveform,  $f = 50 \text{ Hz}$ ,  $T = 1/f$

Notes:

ABB s.r.o., Novodvorska 1768/138a, 142 21 Praha 4, Czech Republic

ABB s.r.o. reserves the right to change the data contained herein at any time without notice