

ABB MS325 motor starter datasheet

<http://www.manuallib.com/abb/ms325-motor-starter-datasheet.html>

Fuse less protection with a manual motor starter saves costs, space and ensures a quick reaction under shortcircuit condition, by switching off the motor within milliseconds. Fuse less starter combinations are setup together with contactors.

ManualLib.com collects and classifies the global product instruction manuals to help users access anytime and anywhere, helping users make better use of products.

<http://www.manuallib.com>

Manual motor starter MS325

Manual motor starters are electro-mechanical protection devices for the main circuit. They are used mainly to switch motors manually ON/OFF and protect them fuse less against short-circuit, overload and phase failures.

Fuse less protection with a manual motor starter saves costs, space and ensures a quick reaction under short-circuit condition, by switching off the motor within milliseconds. Fuse less starter combinations are setup together with contactors.

Description

- Overload protection – trip class 10A
- Phase loss sensitivity
- Disconnect function
- Temperature compensation from -25 ... +50 °C
- Adjustable current setting for overload protection
- Suitable for three- and single-phase application
- Trip-free mechanism
- Clear switch position indication ON/OFF



Order data

MS325 screw terminal



Setting range	Type	Trip class	Order code	Pack- ing unit	Weight per PCE
A				PCE	kg
0.10...0.16	MS325-0.16	10A	1SAM150000R1001	1	0.310
0.16...0.25	MS325-0.25	10A	1SAM150000R1002	1	0.310
0.25...0.40	MS325-0.4	10A	1SAM150000R1003	1	0.310
0.40...0.63	MS325-0.63	10A	1SAM150000R1004	1	0.310
0.63...1.00	MS325-1	10A	1SAM150000R1005	1	0.340
1.00...1.60	MS325-1.6	10A	1SAM150000R1006	1	0.370
1.60...2.50	MS325-2.5	10A	1SAM150000R1007	1	0.370
2.50...4.00	MS325-4	10A	1SAM150000R1008	1	0.370
4.00...6.30	MS325-6.3	10A	1SAM150000R1009	1	0.370
6.30...9.0	MS325-9	10A	1SAM150000R1010	1	0.370
9.00...12.5	MS325-12.5	10A	1SAM150000R1011	1	0.370
12.5...16.0	MS325-16	10A	1SAM150000R1012	1	0.370
16.0...20.0	MS325-20	10A	1SAM150000R1013	1	0.370
20.0...25.0	MS325-25	10A	1SAM150000R1014	1	0.370

Note: MS325 with pre-assembled auxiliary contact HKF1-11, please order as follow 1SAM150005R0xxx

Power and productivity
for a better world™



Functional description

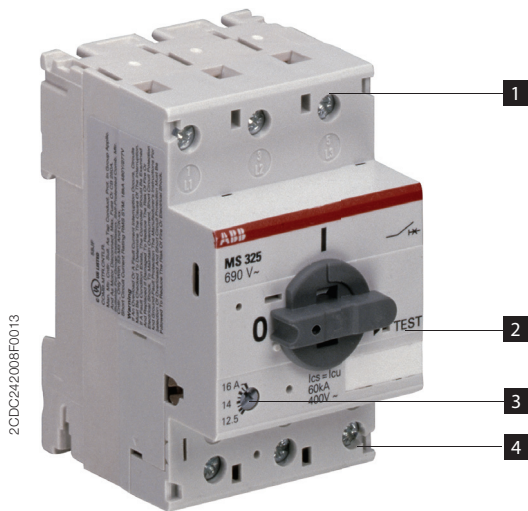

- 1** Terminals 1L1, 3L2, 5L3
- 2** Test function
- 3** Current setting range
Adjustable current setting for overload protection
- 4** Terminals 2T1, 4T2, 6T3

Application

The manual motor starters protect the load and the installation against short-circuit and overload. They are three pole protection devices with thermal tripping elements for overload protection and electromagnetic tripping elements for short-circuit protection. Furthermore, they provide a disconnect function for safely isolation of the installation and the supply and can be used for the manual switching of loads.

The manual motor starters have a setting scale in amperes, which allows the direct adjusting of the device without any additional calculation. In compliance with international and national standards, the setting current is the rated current of the motor and not the tripping current (no tripping at $1.05 \times I$, tripping at $1.2 \times I$; I = setting current).

Operation mode

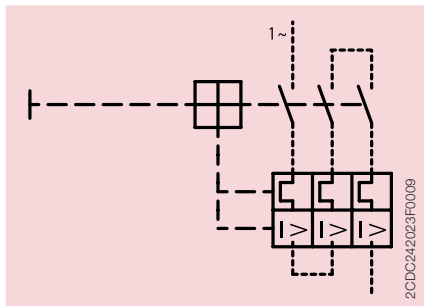

Single-phase operation

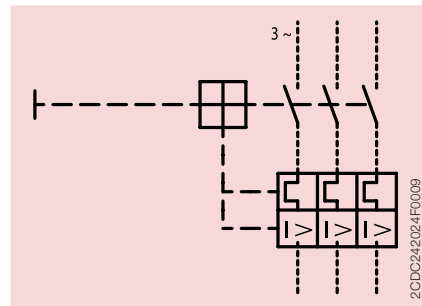

Three-phase operation

Wiring diagram

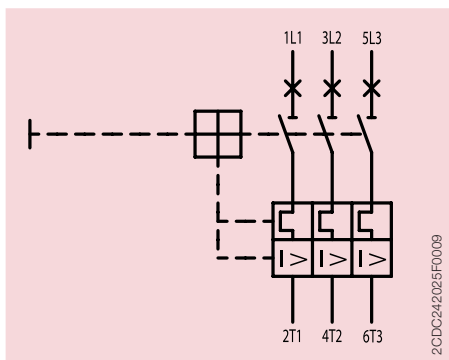

Resistance and power loss per pole

Type	Setting range		Resistance per pole Ω	Power loss per pole	
	lower value A	upper value A		at lower value W	at upper value W
MS325-0.16	0.10	0.16	71.10	0.7	1.8
MS325-0.25	0.16	0.25	27.10	0.7	1.7
MS325-0.4	0.25	0.40	12.30	0.8	2.0
MS325-0.63	0.40	0.63	5.17	0.8	2.1
MS325-1	0.63	1.00	2.090	0.8	2.1
MS325-1.6	1.00	1.60	0.805	0.8	2.1
MS325-2.5	1.60	2.50	0.340	0.9	2.1
MS325-4	2.50	4.00	0.141	0.9	2.3
MS325-6.3	4.00	6.30	0.051	0.8	2.0
MS325-9	6.30	9.0	0.022	0.9	1.8
MS325-12.5	9.00	12.5	0.012	1.0	1.8
MS325-16	12.5	16.0	0.007	1.0	1.7
MS325-20	16.0	20.0	0.004	1.0	1.6
MS325-25	20.0	25.0	0.003	1.1	1.7

Technical diagram

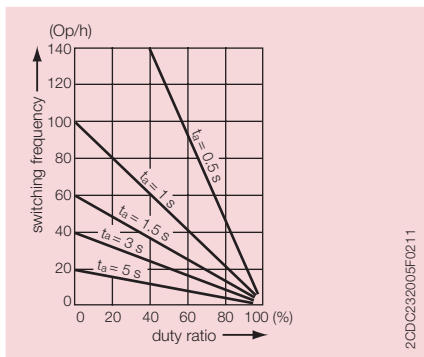

Intermittent periodic duty, t_a : Motor starting time

Dimensions

in mm / inches

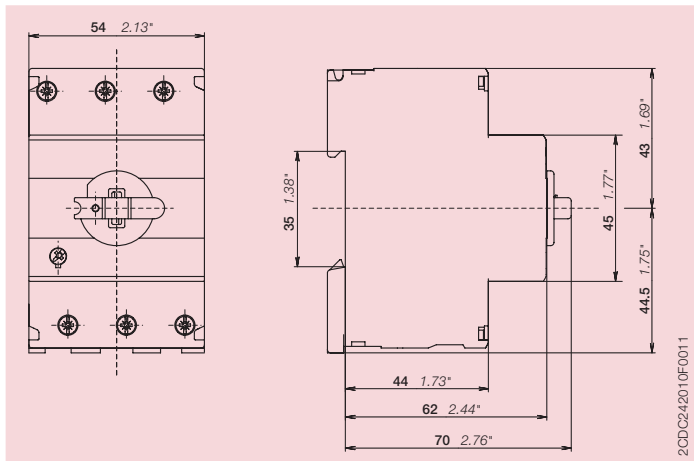

MS325

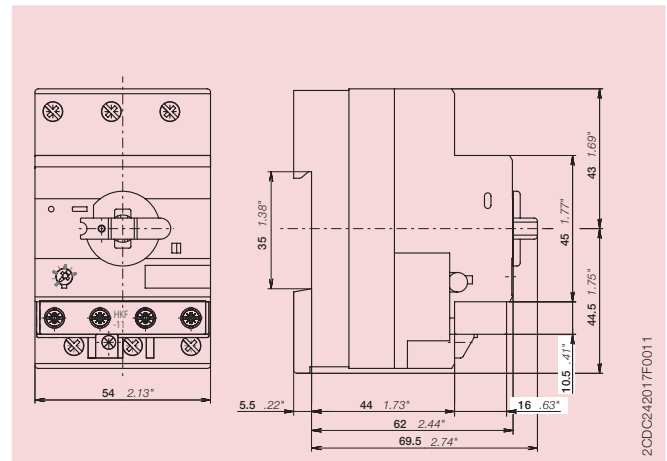

MS325 with HK-F11

Technical data IEC/EN

Data at $T_A = 40\text{ °C}$ and at rated values, if nothing else indicated

Main circuit

		MS325
Rated operational voltage U_e		690 V AC 440 V DC
Setting range - thermal overload protection		see table "Order data" on page 1
Rated operational current I_n		see table below
Rated operational current DC-5 I_e		see "Rated operational current I_e "
3 conducting paths in series up to 250 V		
Rated instantaneous short-circuit current setting I_i		see table below
Rated service short-circuit breaking capacity I_{cs}		see table "Short-circuit breaking capacity and back-up fuses" on page 8
Rated ultimate short-circuit breaking capacity I_{cu}		on request
Rated service short-circuit breaking capacity DC I_{cs}		on request
3 conducting paths in series up to 250 V		
Trip class		see table "Order data" on page 1
Rated frequency		DC, 50/60 Hz
Number of poles		3
Resistance per pole		see table "Resistance and power loss per pole"
Power loss per pole		on page 3

Isolation data

Rated impulse withstand voltage U_{imp}		6 kV
Rated insulation voltage U_i		690 V
Pollution degree		3

Electrical connection

		MS325
Connecting capacity	solid	1/2 x 1 ... 6 mm ²
	stranded	1/2 x 1 ... 6 mm ²
	flexible with ferrule	1/2 x 0.75 ... 4 mm ²
	flexible with ferrule insulated	1/2 x 0.75 ... 4 mm ²
	flexible without ferrule	1/2 x 1 ... 6 mm ²
Stripping length		10 mm
Tightening torques		1.4 Nm
Connection screw		M3.5 (Pozidriv 2)

Type	Rated instantaneous short-circuit current setting I_i	Rated operational current I_e
	A	A
MS325-0.16	1.56	0.16
MS325-0.25	2.44	0.25
MS325-0.4	3.90	0.40
MS325-0.63	6.14	0.63
MS325-1	11.50	1.00
MS325-1.6	18.40	1.60
MS325-2.5	28.75	2.50
MS325-4	50.00	4.00
MS325-6.3	78.75	6.30
MS325-9	135.5	9.00
MS325-12.5	180	12.5
MS325-16	240	16.0
MS325-20	300	20.0
MS325-25	375	25.0

General data

Mechanical durability		100000
Electrical durability		50000
Duty time		100 %
Operating frequency without early tripping		up to 15 operations/h or 60 operations/h with 40 % duty ratio, if the motor breaking current $6 \times I_n$ and the motor starting time does not exceed 1 s
Dimensions (W x H x D)		see drawing "Dimensions" on page 3
Weight		see table "Order data" on page 1
Mounting		DIN-rail (EN 60715)
Mounting position		position 1-6 (optional for single mounting)
Group mounting		on request
Minimum distance to other units same type	horizontal	0 mm
	vertical	100 mm
Minimum distance to electrical conductive board	horizontal, up to 400 V	> 1.5 mm
	horizontal, up to 690 V	> 1.5 mm
	vertical	75 mm
Degree of protection	housing / main circuit terminals	IP20
Utilization category		A
Maximum operating altitude		up to 2000 m
Maximum operating frequency		170 cycles/h

Electromagnetic compatibility

Electromagnetic compatibility		not applicable
-------------------------------	--	----------------

Environmental data

Ambient air temperature	Operation	open - compensated	-25 ... +50 °C
		open	-25 ... +50 °C
		enclosed (IB325)	0 ... +40 °C
	Storage		-50 ... +80 °C
Ambient air temperature compensation			acc. to IEC/EN 60947-4-1
Vibration (sinusoidal) acc. to IEC/EN 60068-2-6 (Fc)			5g / 10 ... 150 Hz
Shock (half-sine) acc. to IEC/EN 60068-2-27 (Ea)			15g / 11 ms

Standards / directives

Product standard	IEC/EN 60947-2
	IEC/EN 60947-4-1
	IEC/EN 60947-1
	UL 508, CSA 22.2 No. 14
Low Voltage Directive	2006/95/EC
EMC Directive	2004/108/EC
RoHS Directive	2002/95/EC

Short-circuit breaking capacity and back-up fuses

I_{cs} Rated service short-circuit breaking capacity

I_{cu} Rated ultimate short-circuit breaking capacity

° No back-up fuse required, because short-circuit proof up to 100 kA

Type	230 V AC			400 V AC			440 V AC			500 V AC			690 V AC		
	I_{cs} kA	I_{cu} kA	gG A	I_{cs} kA	I_{cu} kA	gG A	I_{cs} kA	I_{cu} kA	gG A	I_{cs} kA	I_{cu} kA	gG A	I_{cs} kA	I_{cu} kA	gG A
MS325-0.16	100	100	°	100	100	°	100	100	°	100	100	°	100	100	°
MS325-0.25	100	100	°	100	100	°	100	100	°	100	100	°	100	100	°
MS325-0.4	100	100	°	100	100	°	100	100	°	100	100	°	100	100	°
MS325-0.63	100	100	°	100	100	°	100	100	°	100	100	°	100	100	°
MS325-1	100	100	°	100	100	°	100	100	°	100	100	°	100	100	°
MS325-1.6	100	100	°	100	100	°	100	100	°	100	100	°	100	100	°
MS325-2.5	100	100	°	100	100	°	100	100	°	100	100	°	40	40	25
MS325-4	100	100	°	100	100	°	100	100	°	60	60	40	10	10	40
MS325-6.3	100	100	°	100	100	°	70	70	50	40	40	50	7	7	40
MS325-9	100	100	°	100	100	°	50	50	80	30	30	80	5	5	50
MS325-12.5	100	100	°	75	75	80	45	45	80	27	27	80	4.5	4.5	50
MS325-16	100	100	°	60	60	100	40	40	100	25	25	100	4	4	50
MS325-20	100	100	°	55	55	100	35	35	100	22	22	100	3.5	3.5	50
MS325-25	100	100	°	50	50	125	30	30	125	20	20	125	3	3	50

Technical data UL/CSA

Main circuit

		MS325
Maximum operational voltage		600 V
Manual motor controller ratings		see table "UL 508 – Manual Motor Controller" on page 8
Motor ratings	Horse power	see table below
	Full load amps (FLA)	see table below
	Locked rotor amps (LRA)	see table below

Electrical connection		MS325
Connecting capacity	stranded	1/2 x AWG 14 ... 8
	flexible without ferrule	1/2 x AWG 14 ... 8
Stripping length		10 mm
Tightening torques		14 lb-in
Connection screw		M3.5 (Pozidriv 2)

Motor rating, single phase

hp Horse power

FLA Full load amps

LRA Locked rotor amps

Type	110 ... 120 V AC			220 ... 240 V AC		
	hp	FLA	LRA	hp	FLA	LRA
MS325-0.16	-			-	0.16	0.96
MS325-0.25	-			-	0.25	1.5
MS325-0.4	-			-	0.4	2.4
MS325-0.63	-			-	0.63	3.78
MS325-1	-			-	1	6
MS325-1.6	-			1/10	1.5	
MS325-2.5	-			1/6	2.2	
MS325-4	1/8	3.8		1/3	3.6	
MS325-6.3	1/4	5.8		1/2	4.9	
MS325-9	1/3	7.2		1	8	
MS325-12.5	1/2	9.8		2	12	
MS325-16	1	16		2-1/2		
MS325-20	1-1/2	20		3	17.0	
MS325-25	2	24		3	17.0	

Motor rating, three phase

hp Horse power

FLA Full load amps

LRA Locked rotor amps

Type	220 ... 240 V AC			440 ... 480 V AC			550 ... 600 V AC		
	hp	FLA	LRA	hp	FLA	LRA	hp	FLA	LRA
MS325-0.16	-	0.16	0.96	-	0.16	0.96	-	0.16	0.96
MS325-0.25	-	0.25	1.5	-	0.25	1.5	-	0.25	1.5
MS325-0.4	-	0.4	2.4	-	0.4	2.4	-	0.4	2.4
MS325-0.63	-	0.63	3.78	-	0.63	3.78	-	0.63	3.78
MS325-1	-	1	6	1/2	1.1	10	1/2	0.9	8
MS325-1.6	-	1.6	9.6	3/4	1.6	12.5	3/4	1.3	10
MS325-2.5	1/2	2.2	20	1	2.1	15	1-1/2	2.4	16
MS325-4	1	4.2	30	2	3.4	25	3	3.9	25.6
MS325-6.3	1-1/2	6	40	3	4.8	32	5	6.1	36.8
MS325-9	2-1/2			5	7.6	46	7-1/2	9.0	50.8
MS325-12.5	3	9.6	64	7-1/2	11.0	63.5	10	11.0	64.8
MS325-16	5	15.2	92	10	14.0	81	10	11.0	64.8
MS325-20	5	15.2	92	10	14.0	81	15	27.0	93
MS325-25	7-1/2	22.0	127	15	21.0	116	20	35.0	116

Manual Motor Controller for Motor Disconnect

Type	Maximum short-circuit current rating	
	480 V	600 V
	kA	kA
MS325-0.16	85	50
MS325-0.25	85	50
MS325-0.4	85	50
MS325-0.63	85	50
MS325-1	85	50
MS325-1.6	85	50
MS325-2.5	85	50
MS325-4	85	50
MS325-6.3	50	50
MS325-9	50	50
MS325-12.5	50	30
MS325-16	50	30
MS325-20	50	30
MS325-25	50	30

Manual Motor Controller for Group Installation

Type	Maximum circuit breaker per UL/NEC	Maximum fuse type (class ...) per UL/NEC	Maximum short-circuit current	Maximum circuit breaker per UL/NEC	Maximum fuse type K5 or RK5 per UL/NEC	Maximum short-circuit current
	480 V	480 V	480 V	600 V	600 V	600 V
		A	kA		A	kA
MS325-0.16	-	1600 (class L)	85	S7H1200	1200	50
MS325-0.25	-	1600 (class L)	85	S7H1200	1200	50
MS325-0.4	-	1600 (class L)	85	S7H1200	1200	50
MS325-0.63	-	1600 (class L)	85	S7H1200	1200	50
MS325-1	-	1600 (class L)	85	S7H1200	1200	50
MS325-1.6	-	1600 (class L)	85	S7H1200	1200	50
MS325-2.5	-	1600 (class L)	85	S7H1200	1200	50
MS325-4	-	1600 (class L)	85	S7H1200	1200	50
MS325-6.3	S7H1200	600 (class K5)	50	S7H1200	1200	50
MS325-9	S7H1200	600 (class K5)	50	S4H250	250	50
MS325-12.5	S4H250	400 (class K5)	50	S7H1200	1200	30
MS325-16	S4H250	400 (class K5)	50	S7H1200	1200	30
MS325-20	S4H250	400 (class K5)	50	S4H250	250	30
MS325-25	S4H250	400 (class K5)	50	S4H250	250	30

Self-Protected (Type E) Combination Motor Controller and Tap Conductor Protection

Type	UL 508 Self-Protected (Type E) Combination Motor Controller	for Tap Conductor Protection
	Maximum short-circuit current	Maximum short-circuit current
	480 V	480 V
	kA	kA
MS325-0.16	18	18
MS325-0.25	18	18
MS325-0.4	18	18
MS325-0.63	18	18
MS325-1	18	18
MS325-1.6	18	18
MS325-2.5	18	18
MS325-4	18	18
MS325-6.3	18	18
MS325-9	18	18
MS325-12.5	18	18
MS325-16	18	18
MS325-20	18	18
MS325-25	18	18

Contact us

ABB STOTZ-KONTAKT GmbH

Eppelheimer Straße 82
69123 Heidelberg, Germany
Phone: +49 (0) 6221 7 01-0
Fax: +49 (0) 6221 7 01-13 25
E-Mail: info.desto@de.abb.com

You can find the address of your
local sales organization on the
ABB home page
<http://www.abb.com/contacts>
-> Low Voltage Products and Systems

Note:

We reserve the right to make technical changes or modify the contents of this document without prior notice. With regard to purchase orders, the agreed particulars shall prevail. ABB AG does not accept any responsibility whatsoever for potential errors or possible lack of information in this document.

We reserve all rights in this document and in the subject matter and illustrations contained therein. Any reproduction, disclosure to third parties or utilization of its contents – in whole or in parts – is forbidden without prior written consent of ABB AG.

Copyright© 2014 ABB
All rights reserved

Document number 2CDC 131 046 D0201 (02.2014)

Power and productivity
for a better world™

