

NTGS3446

Power MOSFET 5.1 Amps, 20 Volts N-Channel TSOP-6

Features

- Ultra Low $R_{DS(on)}$
- Higher Efficiency Extending Battery Life
- Logic Level Gate Drive
- Diode Exhibits High Speed, Soft Recovery
- Avalanche Energy Specified
- I_{DSS} Specified at Elevated Temperature
- Pb-Free Package is Available

Applications

- Power Management in portable and battery-powered products, i.e. computers, printers, PCMCIA cards, cellular and cordless
- Lithium Ion Battery Applications
- Notebook PC

MAXIMUM RATINGS ($T_C = 25^\circ\text{C}$ unless otherwise noted)

Rating	Symbol	Value	Unit
Drain-to-Source Voltage	V_{DSS}	20	V
Gate-to-Source Voltage	V_{GS}	± 12	V
Thermal Resistance Junction-to-Ambient (Note 1) Total Power Dissipation @ $T_A = 25^\circ\text{C}$	$R_{\theta JA}$ P_d	244 0.5	$^\circ\text{C/W}$ W
Drain Current - Continuous @ $T_A = 25^\circ\text{C}$ - Pulsed Drain Current ($t_p < 10 \mu\text{s}$)	I_D I_{DM}	2.5 10	A A
Thermal Resistance Junction-to-Ambient (Note 2) Total Power Dissipation @ $T_A = 25^\circ\text{C}$	$R_{\theta JA}$ P_d	128 1.0	$^\circ\text{C/W}$ W
Drain Current - Continuous @ $T_A = 25^\circ\text{C}$ - Pulsed Drain Current ($t_p < 10 \mu\text{s}$)	I_D I_{DM}	3.6 14	A A
Thermal Resistance Junction-to-Ambient (Note 3) Total Power Dissipation @ $T_A = 25^\circ\text{C}$	$R_{\theta JA}$ P_d	62.5 2.0	$^\circ\text{C/W}$ W
Drain Current - Continuous @ $T_A = 25^\circ\text{C}$ - Pulsed Drain Current ($t_p < 10 \mu\text{s}$)	I_D I_{DM}	5.1 20	A A
Source Current (Body Diode)	I_S	5.1	A
Operating and Storage Temperature Range	T_J, T_{stg}	-55 to 150	$^\circ\text{C}$
Maximum Lead Temperature for Soldering Purposes for 10 seconds	T_L	260	$^\circ\text{C}$

Maximum ratings are those values beyond which device damage can occur. Maximum ratings applied to the device are individual stress limit values (not normal operating conditions) and are not valid simultaneously. If these limits are exceeded, device functional operation is not implied, damage may occur and reliability may be affected.

1. Minimum FR-4 or G-10PCB, operating to steady state.
2. Mounted onto a 2" square FR-4 board (1" sq. 2 oz. cu. 0.06" thick single-sided), operating to steady state.
3. Mounted onto a 2" square FR-4 board (1" sq. 2 oz. cu. 0.06" thick single-sided), $t < 5.0$ seconds.



ON Semiconductor®

<http://onsemi.com>

$V_{(BR)DSS}$	$R_{DS(on)}$ TYP	I_D MAX
20 V	36 m Ω @ 4.5 V	5.1 A

N-Channel

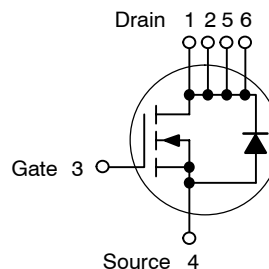

MARKING DIAGRAM



TSOP-6
CASE 318G
STYLE 1

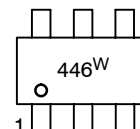

446 = Device Code
W = Work Week

PIN ASSIGNMENT

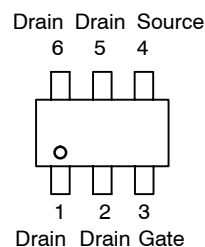

ORDERING INFORMATION

Device	Package	Shipping†
NTGS3446T1	TSOP-6	3000/Tape & Reel
NTGS3446T1G	TSOP-6 (Pb-Free)	3000/Tape & Reel

†For information on tape and reel specifications, including part orientation and tape sizes, please refer to our Tape and Reel Packaging Specification Brochure, BRD8011/D.

NTGS3446

ELECTRICAL CHARACTERISTICS (T_C = 25°C unless otherwise noted)

Characteristic	Symbol	Min	Typ	Max	Unit
----------------	--------	-----	-----	-----	------

OFF CHARACTERISTICS

Drain-to-Source Breakdown Voltage (V _{GS} = 0 Vdc, I _D = 0.25 mAdc) Temperature Coefficient (Positive)	V _{(BR)DSS}	20 -	- 22	- -	Vdc mV/°C
Zero Gate Voltage Collector Current (V _{DS} = 20 Vdc, V _{GS} = 0 Vdc) (V _{DS} = 20 Vdc, V _{GS} = 0 Vdc, T _J = 85°C)	I _{DSS}	- -	- -	1.0 25	μAdc
Gate-Body Leakage Current (V _{GS} = ±12 Vdc, V _{DS} = 0)	I _{GSS(f)} I _{GSS(r)}	- -	- -	100 -100	nAdc

ON CHARACTERISTICS (Note 4)

Gate Threshold Voltage I _D = 0.25 mA, V _{DS} = V _{GS} Temperature Coefficient (Negative)	V _{GS(th)}	0.6 -	0.85 -2.5	1.2 -	Vdc mV/°C
Static Drain-to-Source On-Resistance (V _{GS} = 4.5 Vdc, I _D = 5.1 Adc) (V _{GS} = 2.5 Vdc, I _D = 4.4 Adc)	R _{DS(on)}	- -	36 44	45 55	mΩ
Forward Transconductance (V _{DS} = 10 Vdc, I _D = 5.1 Adc)	g _{FS}	-	12	-	mhos

DYNAMIC CHARACTERISTICS

Input Capacitance	(V _{DS} = 10 Vdc, V _{GS} = 0 Vdc, f = 1.0 MHz)	C _{ISS}	-	510	750	pF
Output Capacitance		C _{OSS}	-	200	350	
Transfer Capacitance		C _{RSS}	-	60	100	

SWITCHING CHARACTERISTICS (Note 5)

Turn-On Delay Time	(V _{DD} = 10 Vdc, I _D = 1.0 Adc, V _{GS} = 4.5 Vdc, R _G = 6.0 Ω)	t _{d(on)}	-	9.0	16	ns
Rise Time		t _r	-	12	20	
Turn-Off Delay Time		t _{d(off)}	-	35	60	
Fall Time		t _f	-	20	35	
Gate Charge	(V _{DS} = 10 Vdc, I _D = 5.1 Adc, V _{GS} = 4.5 Vdc)	Q _T	-	8.0	15	nC
		Q _{gs}	-	2.0	-	
		Q _{gd}	-	2.0	-	

SOURCE-DRAIN DIODE CHARACTERISTICS

Forward On-Voltage (Note 4)	(I _S = 1.7 Adc, V _{GS} = 0 Vdc) (I _S = 1.7 Adc, V _{GS} = 0 Vdc, T _J = 85°C)	V _{SD}	- -	0.74 0.66	1.1 -	Vdc
Reverse Recovery Time		(I _S = 1.7 Adc, V _{GS} = 0 Vdc, di _S /dt = 100 A/μs)	t _{rr}	-	20	-
	t _a		-	11	-	
	t _b		-	9.0	-	
Reverse Recovery Stored Charge		Q _{RR}	-	0.01	-	μC

- Pulse Test: Pulse Width ≤ 300 μs, Duty Cycle ≤ 2%.
- Switching characteristics are independent of operating junction temperature.

NTGS3446

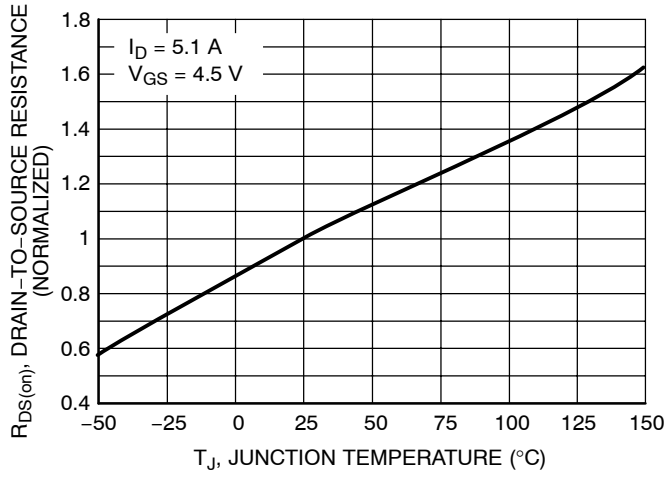

Figure 1. On-Resistance Variation with Temperature

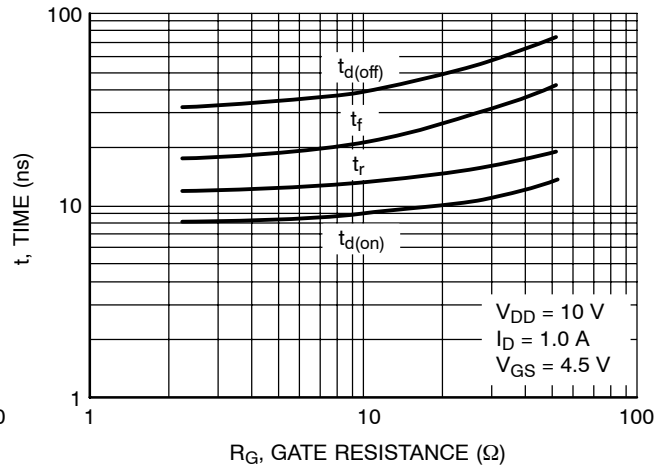
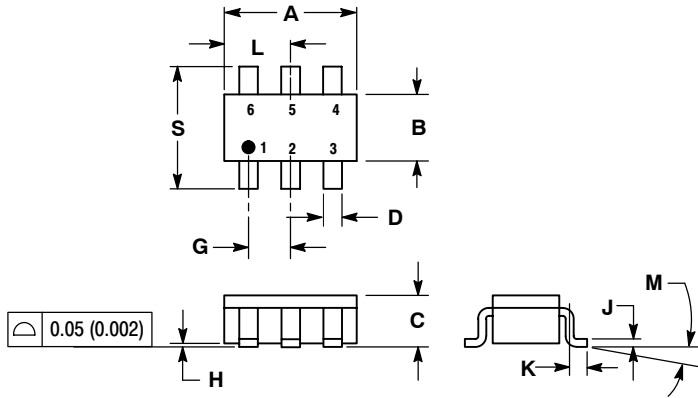

Figure 2. Resistive Switching Time Variation vs. Gate Resistance

NTGS3446

PACKAGE DIMENSIONS

TSOP-6
CASE 318G-02
ISSUE N



NOTES:

1. DIMENSIONING AND TOLERANCING PER ANSI Y14.5M, 1982.
2. CONTROLLING DIMENSION: MILLIMETER.
3. MAXIMUM LEAD THICKNESS INCLUDES LEAD FINISH THICKNESS. MINIMUM LEAD THICKNESS IS THE MINIMUM THICKNESS OF BASE MATERIAL.
4. DIMENSIONS A AND B DO NOT INCLUDE MOLD FLASH, PROTRUSIONS, OR GATE BURRS.

DIM	MILLIMETERS		INCHES	
	MIN	MAX	MIN	MAX
A	2.90	3.10	0.1142	0.1220
B	1.30	1.70	0.0512	0.0669
C	0.90	1.10	0.0354	0.0433
D	0.25	0.50	0.0098	0.0197
G	0.85	1.05	0.0335	0.0413
H	0.013	0.100	0.0005	0.0040
J	0.10	0.26	0.0040	0.0102
K	0.20	0.60	0.0079	0.0236
L	1.25	1.55	0.0493	0.0610
M	0°	10°	0°	10°
S	2.50	3.00	0.0985	0.1181

STYLE 1:

1. DRAIN
2. DRAIN
3. GATE
4. SOURCE
5. DRAIN
6. DRAIN

SOLDERING FOOTPRINT*

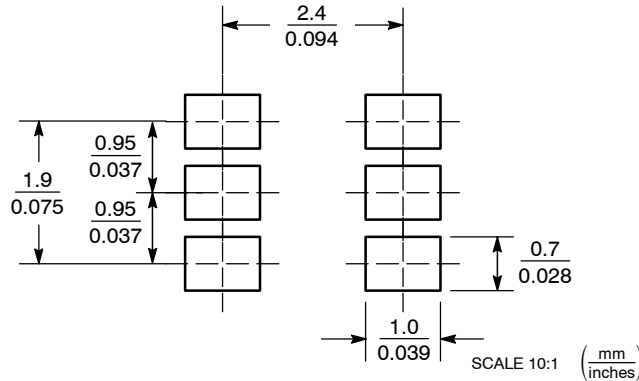

*For additional information on our Pb-Free strategy and soldering details, please download the ON Semiconductor Soldering and Mounting Techniques Reference Manual, SOLDERRM/D.

ON Semiconductor and are registered trademarks of Semiconductor Components Industries, LLC (SCILLC). SCILLC reserves the right to make changes without further notice to any products herein. SCILLC makes no warranty, representation or guarantee regarding the suitability of its products for any particular purpose, nor does SCILLC assume any liability arising out of the application or use of any product or circuit, and specifically disclaims any and all liability, including without limitation special, consequential or incidental damages. "Typical" parameters which may be provided in SCILLC data sheets and/or specifications can and do vary in different applications and actual performance may vary over time. All operating parameters, including "Typicals" must be validated for each customer application by customer's technical experts. SCILLC does not convey any license under its patent rights nor the rights of others. SCILLC products are not designed, intended, or authorized for use as components in systems intended for surgical implant into the body, or other applications intended to support or sustain life, or for any other application in which the failure of the SCILLC product could create a situation where personal injury or death may occur. Should Buyer purchase or use SCILLC products for any such unintended or unauthorized application, Buyer shall indemnify and hold SCILLC and its officers, employees, subsidiaries, affiliates, and distributors harmless against all claims, costs, damages, and expenses, and reasonable attorney fees arising out of, directly or indirectly, any claim of personal injury or death associated with such unintended or unauthorized use, even if such claim alleges that SCILLC was negligent regarding the design or manufacture of the part. SCILLC is an Equal Opportunity/Affirmative Action Employer. This literature is subject to all applicable copyright laws and is not for resale in any manner.

PUBLICATION ORDERING INFORMATION

LITERATURE FULFILLMENT:
Literature Distribution Center for ON Semiconductor
P.O. Box 61312, Phoenix, Arizona 85082-1312 USA
Phone: 480-829-7710 or 800-344-3860 Toll Free USA/Canada
Fax: 480-829-7709 or 800-344-3867 Toll Free USA/Canada
Email: orderlit@onsemi.com

N. American Technical Support: 800-282-9855 Toll Free
USA/Canada

Japan: ON Semiconductor, Japan Customer Focus Center
2-9-1 Kamimeguro, Meguro-ku, Tokyo, Japan 153-0051
Phone: 81-3-5773-3850

ON Semiconductor Website: <http://onsemi.com>

Order Literature: <http://www.onsemi.com/litorder>

For additional information, please contact your local Sales Representative.