

---

8472B  
Crystal Detector

Operating and Service  
Manual

---



Part number: 08472-90022  
Printed in USA  
Print Date: May 2001  
Supersedes: April 1999

---

## Notice

The information contained in this document is subject to change without notice.

Agilent Technologies makes no warranty of any kind with regard to this material, including, but not limited to, the implied warranties of merchantability and fitness for a particular purpose. Agilent Technologies shall not be liable for errors contained herein or for incidental or consequential damages in connection with the furnishing, performance, or use of this material.

Agilent Technologies assumes no responsibility for the use or reliability of its software on equipment that is not furnished by Agilent Technologies.

This document contains proprietary information which is protected by copyright. All rights are reserved. No part of this document may be photocopied, reproduced, or translated to another language without prior written consent of Agilent Technologies Inc..

### Restricted Rights Legend

Use, duplication, or disclosure by the U.S. Government is subject to restrictions as set forth in subparagraph (c)(1)(ii) of the Rights in Technical Data and Computer Software clause at DFARS 252.227-7013 for DOD agencies, and subparagraphs (c)(1) and (c)(2) of the Commercial Computer Software Restricted Rights clause at FAR 52.227-19 for other agencies.

Agilent Technologies Inc.  
Santa Rosa Systems Division  
1400 Fountaingrove Parkway  
Santa Rosa, CA 95403-1799, U.S.A.

---

## Warranty

### Certification

*Agilent Technologies certifies that this product met its published specifications at the time of shipment from the factory. Agilent Technologies further certifies that its calibration measurements are traceable to the United States National Institute of Standards and Technology (NIST, formerly NBS), to the extent allowed by the Institute's calibration facility, and to the calibration facilities of other International Standards Organization members.*

### Warranty

This Agilent Technologies system product is warranted against defects in materials and workmanship for a period corresponding to the individual warranty periods of its component products. Instruments are warranted for a period of one year. During the warranty period, Agilent Technologies will, at its option, either repair or replace products that prove to be defective.

Warranty service for products installed by Agilent and certain other products designated by Agilent will be performed at Buyer's facility at no charge within Agilent service travel areas. Outside Agilent service travel areas, warranty service will be performed at Buyer's facility only upon Agilent's prior agreement and Buyer shall pay Agilent's round trip travel expenses. In all other areas, products must be returned to a service facility designated by Agilent.

For products returned to Agilent for warranty service, Buyer shall prepay shipping charges to Agilent and Agilent shall pay shipping charges to return the product to Buyer. However, Buyer shall pay all shipping charges, duties, and taxes for products returned to Agilent from another country.

Agilent warrants that its software and firmware designated by Agilent for use with an instrument will execute its programming instructions when properly installed on that instrument. Agilent does not warrant that the operation of the instrument, or software, or firmware will be uninterrupted or error free.

**LIMITATION OF WARRANTY.** The foregoing warranty shall not apply to defects resulting from improper or inadequate maintenance by Buyer, Buyer-supplied software or interfacing, unauthorized modification or misuse, operation outside of the environmental specifications for the product, or improper site preparation or maintenance.

NO OTHER WARRANTY IS EXPRESSED OR IMPLIED. AGILENT SPECIFICALLY DISCLAIMS THE IMPLIED WARRANTIES OR MERCHANTABILITY AND FITNESS FOR A PARTICULAR PURPOSE.

**EXCLUSIVE REMEDIES.** THE REMEDIES PROVIDED HEREIN ARE BUYER'S SOLE AND EXCLUSIVE REMEDIES. AGILENT SHALL NOT BE LIABLE FOR ANY DIRECT, INDIRECT, SPECIAL,

INCIDENTAL, OR CONSEQUENTIAL DAMAGES, WHETHER BASED ON CONTRACT, TORT, OR ANY OTHER LEGAL THEORY.

## **Assistance**

Product maintenance agreements and other customer assistance agreements are available for Agilent Technologies products.

For assistance, call your local Agilent Technologies Sales and Service Office (refer to [“Service and Support” on page v](#)).

---

## Service and Support

By internet, phone, or fax, get assistance with all your test and measurement needs.

**Online assistance:** [www.agilent.com/find/assist](http://www.agilent.com/find/assist)

---

<b>United States</b> (tel) 1 800 452 4844	<b>Latin America</b> (tel) (305) 269 7500 (fax) (305) 269 7599	<b>Canada</b> (tel) 1 877 894 4414 (fax) (905) 282-6495	<b>Europe</b> (tel) (+31) 20 547 2323 (fax) (+31) 20 547 2390
<b>New Zealand</b> (tel) 0 800 738 378 (fax) (+64) 4 495 8950	<b>Japan</b> (tel) (+81) 426 56 7832 (fax) (+81) 426 56 7840	<b>Australia</b> (tel) 1 800 629 485 (fax) (+61) 3 9210 5947	

---

### Asia Call Center Numbers

Country	Phone Number	Fax Number
Singapore	1-800-375-8100	(65) 836-0252
Malaysia	1-800-828-848	1-800-801664
Philippines	(632) 8426802 1-800-16510170 (PLDT Subscriber Only)	(632) 8426809 1-800-16510288 (PLDT Subscriber Only)
Thailand	(088) 226-008 (outside Bangkok) (662) 661-3999 (within Bangkok)	(66) 1-661-3714
Hong Kong	800-930-871	(852) 2506 9233
Taiwan	0800-047-866	(886) 2 25456723
People's Republic of China	800-810-0189 (preferred) 10800-650-0021	10800-650-0121
India	1-600-11-2929	000-800-650-1101

Any adjustment, maintenance, or repair of this product must be performed by qualified personnel. Contact your customer engineer through your local Agilent Service Center. If you do not have access to the Internet, one of these Agilent centers can direct you to your nearest Agilent representative:

---

## Safety and Regulatory Information

Review this product and related documentation to familiarize yourself with safety marking and instructions before you operate the instrument. This product has been designed and tested in accordance with international standards.

---

### WARNING

---

The **WARNING** notice denotes a hazard. It calls attention to a procedure, practice, or the like, that, if not correctly performed or adhered to, could result in personal injury. Do not proceed beyond a **WARNING** notice until the indicated conditions are fully understood and met.

---









### CAUTION

---

The **CAUTION** notice denotes a hazard. It calls attention to an operating procedure, practice, or the like, which, if not correctly performed or adhered to, could result in damage to the product or loss of important data. Do not proceed beyond a **CAUTION** notice until the indicated conditions are fully understood and met.

## Instrument Markings

---

	When you see this symbol on your instrument, you should refer to the instrument's instruction manual for important information.
	This symbol indicates hazardous voltages.
	The laser radiation symbol is marked on products that have a laser output.
	This symbol indicates that the instrument requires alternating current (ac) input.
	The CE mark is a registered trademark of the European Community. If it is accompanied by a year, it indicates the year the design was proven.
	The CSA mark is a registered trademark of the Canadian Standards Association.
1SM1-A	This text indicates that the instrument is an Industrial Scientific and Medical Group 1 Class A product (CISPER 11, Clause 4).
	This symbol indicates that the power line switch is ON.
	This symbol indicates that the power line switch is OFF or in STANDBY position.

---

---

# Contents

Notice .....	ii
Restricted Rights Legend .....	ii
Warranty .....	iii
Certification .....	iii
Assistance .....	iv
Service and Support .....	v
Safety and Regulatory Information .....	vi
Description .....	1
Installation .....	2
Initial Inspection .....	2
Storage and Shipment .....	2
Specifications .....	3
Operating Information .....	4
Operator's Checks .....	5
Peak Power Measurement .....	5
Reflectometer Application .....	6
Harmony Frequency Comparison Measurement Application .....	6
Performance Tests .....	7
Frequency Response Test .....	7
Higher Level Sensitivity Test .....	7
Low Level Sensitivity Test .....	7
Match Test (SWR) .....	7
Service Instructions .....	8
Repair and Replacement .....	8
Replaceable Parts .....	8
Detector Element Replacement .....	8

---

## Description

The 8472B crystal detector is a 50  $\Omega$  (nominal) device designed for measurement use in coaxial systems.

- Features**
- The instrument converts RF power levels applied to the 50  $\Omega$  input connector into proportional values of dc voltage.
  - The instrument measures relative power up to 200 mW and has a BNC female connector for the output jack which allows the detected output to be connected to a SWR meter.
  - The output voltage polarity is negative, unless Option 003 is selected.
  - The frequency range of the detector is 10 MHz to 18 GHz.

**Options** The 8472B crystal detector is available with the following options. Refer to Table 1 for further descriptions.

Option 001: Matched pair of detectors

Option 002: Optimum square law load

Option 003: Positive polarity output

Option 100: Female OSSM type output connector

- Mating Connectors**
- The mating output connector used with the crystal detector must be a male BNC connector for the standard output connector or an OSSM male connector for Option 100.
  - The mating RF input connector must be a female SMA connector.

---

### CAUTION

---

SMA connectors have a limited life in applications that require repeated connecting and disconnecting. In-series adapters should be used for such applications.



---

## Installation

### Initial Inspection

1. Inspect the shipping container for damage. If the shipping container or cushioning material is damaged, it should be kept until the contents of the shipment have been checked for completeness and the instrument has been checked mechanically and electrically. Procedures for checking electrical performance are given under Performance Tests.
2. If the contents are incomplete, if there is mechanical damage or defect, or if the instrument does not pass the electrical performance test, contact the nearest Agilent Technologies office. Refer to [“Service and Support” on page v](#). Agilent Technologies will arrange for repair or replacement of the damaged or defective equipment. Keep the shipping materials for the carrier’s inspection.
3. If you are returning the instrument for service, repackaging the instrument requires original shipping containers and materials or their equivalents. Agilent Technologies can provide packaging materials identical to the original materials. Refer to [“Service and Support” on page v](#). Attach a tag indicating the type of service required, return address, model number and serial number. Mark the container **FRAGILE** to insure careful handling. In any correspondence, refer to the instrument by model number and serial number.

### Storage and Shipment

The instrument should be stored in a clean, dry environment. The following environmental limitations apply to both storage and shipment:

- a. Temperature:            –54 C to +85 °C
- b. Altitude                    < 7620 meters (25,000 feet)
- c. Humidity                    < 95% relative
- d. Shock                        100 G for 11 ms
- e. Vibration                    20 G from 80 to 2000 Hz

## Specifications

Specifications are performance standards or limits against which the detectors are tested.

**Table 1 Specifications**

<p><b>Frequency Range:</b> 10 MHz to 18 GHz</p> <p><b>Note:</b> RF may leak through the output connector below 1 GHz. It can be reduced, if objectionable, with a suitable low pass filter.</p> <p><b>Frequency Response:</b><sup>1, 2, 4</sup></p> <p>Octave flatness: ±0.2 dB over any octave 10 MHz to 8 GHz</p> <p>Broadband flatness: ±0.3 dB 10 MHz to 12.4 GHz ±0.5 dB 10 MHz to 15 GHz ±0.6 dB 10 MHz to 18 GHz</p> <p><b>SWR</b><sup>1,2</sup> (Max): 10 MHz to 4.5 GHz, 1.2 4.5 GHz to 7.0 GHz, 1.35 7.0 GHz to 12.4 GHz, 1.50 12.4 GHz to 18 GHz, 1.70</p> <p><b>Maximum Operating Input Power:</b> 200 mW, peak or average</p> <p><b>Maximum Short Term Input Power:</b> 1 watt (typical) peak or average for &lt; 1 minute</p> <p><b>Sensitivity:</b><sup>1, 3, 4</sup> High level: &lt; 0.35 mW produces 100 mV output Low level: &gt; 0.5 mVdc/μW CW</p> <p><b>Input Impedance:</b> 50 Ω (nominal)</p> <p><b>Output Impedance:</b><sup>2</sup> 1 to 2 k Ω (typically 1.3 k Ω) shunted by 40 to 60 pF (typically 50 pF).</p> <p><b>Output Polarity:</b> Negative (refer to Options for positive polarity units).</p> <p><b>Detector Element:</b> Supplied (refer to Table 2 for replacement elements)</p> <p><b>Bias:</b> Not required</p> <p><b>Noise:</b> &lt; 50 μVpp with CW applied to produce 100 mV output, 400 kHz bandwidth.</p>	<p><b>Options:</b></p> <p><b>Option 001:</b> Matched detector pair. Frequency response characteristics (exclusive of basic sensitivity) track within ±0.2 dB from 10 MHz to 12.4 GHz, ±0.3 dB from 12.4 GHz to 18 GHz.</p> <p><b>Option 002:</b> Furnished with matched load resistor for optimum square law characteristics of 25 °C, within ±0.5 dB from square law over a range of at least 30 dB up to 10 mV peak output, working into an external load &gt; 8 k Ω. Sensitivity typically is greater than 0.1 mV/μW when load resistor is used.</p> <p><b>Option 003:</b> Positive polarity output</p> <p><b>Option 100:</b> Female OSSM-type output connector</p> <p><b>Environmental:</b> Operating temperature: -20 to +85 °C Humidity: &lt; 95% relative Vibration: 20 G from 80 to 2000 Hz Shock: 100 G for 11 ms Altitude: &lt; 4570 meters (15,000 feet)</p> <p><b>General:</b> Weight: Net 57 g (2 oz.) Dimensions: 64 mm long, 14 mm diameter (2.50 in. long, 0.56 in. diameter)</p> <p>1. Specifications given for +25° C unless otherwise noted 2. Measurement made at -20 dBm 3. Sensitivity decreases with increasing temperature, typically: 0.5 dB from -20 to +25 °C; 0.5 dB from +25 to +40 °C; 1 dB from +40 to +55 °C; 1.25 dB from +55 to +75 °C; 1 dB from +75 to +85 °C. 4. External load resistance &gt; 50 k Ω</p>
---	--

---

## Operating Information

The crystal detector can be used as a demodulator to obtain a pulse envelope which can then be observed on an oscilloscope. It can also be used as a general purpose detector.

---

### CAUTION

- Static discharge can damage the detector element. A 100 pF capacitor (1.2 m [4 ft] of coax cable) charged to 14 volts stores .1 erg, the maximum pulse rating of the detector element.
- Connect cables to test equipment and discharge the center conductor before you connect to the detector.
- **DO NOT NEEDLESSLY HANDLE THE DETECTOR ELEMENT USED IN CRYSTAL DETECTOR.** Static electricity which builds up on a person, especially on a cold dry day, must never be allowed to discharge through the crystal detector.
- Avoid exposed leads to or from the crystal detector, since these are often touched accidentally.

---

The power applied to the detector can be either modulated or continuous wave (CW). If modulated at a 1000 Hz rate, a SWR meter can be used as an indicator. For CW detection, a dc milliammeter or millivoltmeter can be used as the indicator.

---

### NOTE

When using the crystal detector with an oscilloscope, and the waveshapes to be observed have rise times of less than 5 $\mu$ s, the coaxial cable connecting oscilloscope and detector should be as short as possible and shunted with a resistor.

Ideally, this resistor should be 50  $\Omega$  to terminate the coaxial cable properly. However, with 50  $\Omega$  resistance, the output video pulse may be too small to drive some oscilloscopes. Therefore, the cable should be shunted with the smallest value of resistance that will obtain suitable deflection on the oscilloscope; typically the value will lie between 50  $\Omega$  and 2 k  $\Omega$ . The larger the resistance, the more degradation of rise time.

## Operator's Checks

### Peak Power Measurement

The procedure for peak power measurement involves calibration of an oscilloscope which, in turn, is used to calibrate a CW generator. The output of the calibrated CW generator is measured with a power meter and thereby the peak power of a pulse is measured.

Refer to Figure 1 for the equipment setup in the steps referenced below.

1. Measure the output amplitude resulting from the pulse.
  - a. Connect equipment as shown in Figure 1, step A.
  - b. Observe the pulse on a de-coupled oscilloscope.
  - c. Using a marking pencil, mark on the graticule the base-to-peak amplitude of the pulse envelope.
2. Match the output amplitude to the CW source power.
  - a. Replace the pulse source with a CW generator.
  - b. While observing the oscilloscope trace, adjust the amplitude of CW generator output to make the detector's output equal to that of the pulse generator, as indicated by markings on the graticule (step A).
3. Measure the output power from the CW source.
  - a. Leave the CW generator at the setting obtained in step B.
  - b. Disconnect the detector from CW generator.
  - c. Connect the output of CW generator to the power meter (step C).
  - d. Measure the adjusted levels (set in step B) of the CW generator output. The peak power of the pulse envelope observed in step A is equal to the output power of the CW generator.

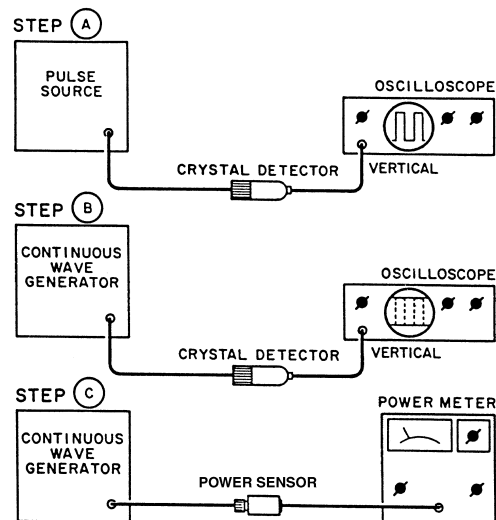

**Figure 1** Peak Power Measurement

## Operating Information

### **Reflectometer Application**

For information about reflectometer systems and measurements refer to Agilent Technologies Application Note Index. Copies are available upon request.

### **Harmony Frequency Comparison Measurement Application**

The detector can be used as a mixer in harmonic-frequency comparison measurements. Refer to Agilent Technologies Application Note Index for further information.

---

## Performance Tests

Methods for testing detector specifications are given below. Refer to the manuals of the equipment involved for specific operating instructions.

---

### NOTE

Multiple mismatch errors caused by attenuator SWR, power meter SWR, and detector SWR should be taken into account, as well as the accuracy of the indicator used to measure the detector's output.

---

### Frequency Response Test

1. Using signal sources covering 10 MHz to 18 GHz with a 10 dB isolating attenuator and a power meter, connect the power sensor to the attenuator. Adjust the CW RF power level to  $-20$  dBm input to the power sensor.
2. Without changing the RF power level of signal source, disconnect the power sensor.
3. Connect the detector to the attenuator. Measure the dc voltage output and record the measurement.
4. Change the frequency of the signal source and repeat steps 1 through 3.
5. Since the detector follows a square-law response at this power level, its output is proportional to power ( $P_{dB} = 10 \log V_o$ ). Total variation of detector readings should meet specifications (refer to Table 1) for all frequencies of interest across the band.

### Higher Level Sensitivity Test

1. Using signal sources covering 10 MHz to 18 GHz and a dc voltmeter or oscilloscope as the indicator, connect the detector to the signal source. Adjust the RF power level for a 100 mV detected output from the detector, using a CW signal.
2. Disconnect the detector from the signal source and measure the RF output level. The RF output level should be  $\leq 0.35$  mW.
3. Repeat steps 1 and 2 for all frequencies of interest across the band.

### Low Level Sensitivity Test

1. Using a signal source (covering 10 MHz to 18 GHz), a 10 dB attenuator, and a power meter, connect the attenuator to the signal source and power sensor to the attenuator. Adjust the RF power level for  $-20$  dBm output from the attenuator. Verify the ambient temperature.
2. Disconnect the power sensor from the attenuator and connect the detector. Measure the dc voltage output from the detector. The output should be  $> 5.0$  mV at  $25^\circ\text{C}$ . Between  $20^\circ\text{C}$  and  $30^\circ\text{C}$  the sensitivity slope is typically  $-0.04$  dB/ $^\circ\text{C}$ .

### Match Test (SWR)

1. To verify the detector's SWR specifications, use any system whose measurement accuracies for SWR (residual SWR) are known.

## Service Instructions

### Repair and Replacement

Repair and replacement information for the 8472B crystal detector are given below. For additional maintenance information, refer to “Service and Support” on page v for the nearest Agilent Technologies Sales and Service office.

The detectors have no internal adjustments.

### Replaceable Parts

Part numbers for replaceable parts are given in Table 2. To order a replacement part, address your order or inquiry to the nearest Agilent Technologies office. Include the model number, Agilent Technologies part number, and a description.

### Detector Element Replacement

The detector element assembly includes only a detector element. All other internal parts are to be retained for re-use in the detector.

Read the following precautions carefully before performing any operation with the detector element when it is out of either the housing or the detector element shipping container.

---

#### CAUTION

- Before installing the diode into the mount, touch the exposed metal on the mount with your hand to discharge static electricity.
- When handing the diode to another person, first touch hands to ensure that there is no difference in static electricity potential between you.
- Ohmmeters should not be used to measure forward- and back-resistance since it is easy to damage these diodes. The ohmmeter’s open-circuit voltages and short-circuit currents may cause problems.

---

Parts mentioned in the following procedure are identified in Figures 2 and 3 on page 10.

1. Remove the female BNC connector and compression spring from inside of the connector cap.
2. Remove the connector cap from the body. Use a pair of pliers with plastic jaws or protect the body with heavy paper or tape.

---

**CAUTION**

---

- *Do not rotate* the detector element while inserting or removing as damage may result.
  - The detector element might be damaged if the detector element is not centered.
  - When inserting the detector element, do not force the large pin end into the center conductor.
3. Remove the old detector element and the polyiron washer. Discard the detector element.
  4. Install the RF adapter washer, polyiron ring, axial spacer, and new detector element. Refer to Figures 2 and 3 for the proper orientation for the internal components.
    - a. Insert the RF washer first with the large step on the washer facing toward the crystal mount body and the small step on the washer facing toward the detector element.
    - b. Carefully insert the large pin end of the detector element into the center contact inside the detector body.
    - c. Place the polyiron ring and the axial spacer over the small pin end of the detector element. The polyiron ring fits into the axial spacer.
  5. Carefully place the connector cap over the body and assembled components and tighten firmly in place.
  6. Place the compression spring into the center conductor of the female BNC or OSSM connector. Carefully start the spring over the small pin of the detector element through the hole in the connector cap. Keep the spring in the center connector and screw the female connector firmly into place.



Service Instructions

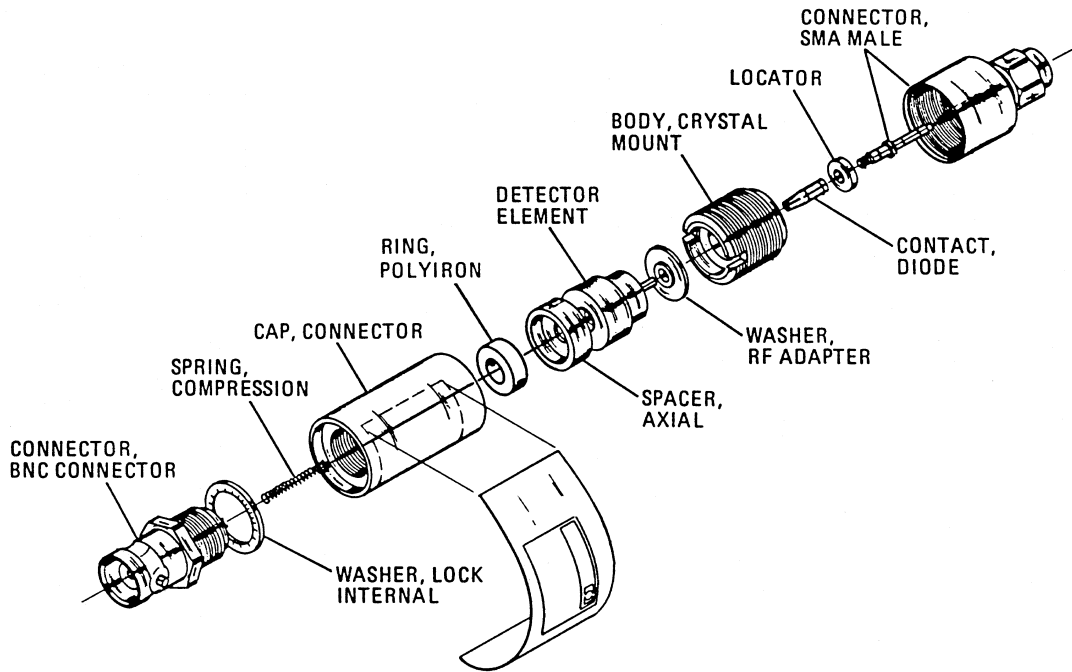

Figure 2 8472B Crystal Detector Assembly

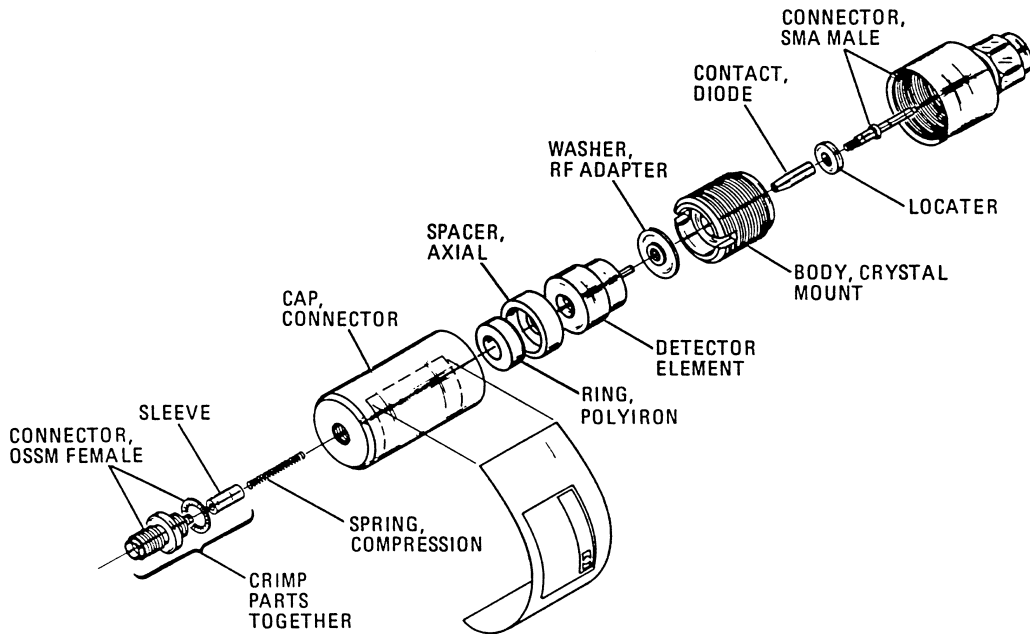

Figure 3 8472B Option 100 Crystal Detector Assembly

**Table 2** *Replaceable Parts*

Description	Part Number
<b>8472B and 8472B, Option 100 Assemblies<sup>1</sup></b>	
Connector, SMA male	1250-0683
Connector, OSSM female (Option 100)	1250-0924
Spring, compression	1460-0072
Washer, lock internal	2190-0016
Ring, polyiron	5021-0801
Spacer, axial	5021-0802
Washer, RF adapter	5021-0127
Body, crystal mount	08472-2001
Cap, connector	08472-2007
Cap, connector, (Option 100)	08472-20011
Sleeve (Option 100)	08472-20012
Pin and bead assembly includes:	5086-1364
Connector, BNC female	1250-0212
Contact, diode	08472-20009
Locator	08742-20002
<b>Replacement Element Diode Assemblies<sup>1</sup></b>	
Single diode negative polarity	08470-60012
Single diode positive polarity (Opt 003)	08470--60013
Matched pair diodes negative polarity (Opt 001)	08470-60016
Matched pair diodes positive polarity (Opt 001 and Option 003)	08470-60017

1. Refer to Table 1 for a description of options.