

# **5.6" Color TFT LCD Monitor**

**Users' Manual**

# I. Safety Warning

1. To prevent fire or shock hazard, do not expose this equipment to the environment of high humidity and dust. Do not use it in an unprotected outdoor installation or any area classified as a wet area.
2. The temperature for installation should be kept between  $-40^{\circ}\text{C} \sim +95^{\circ}\text{C}$ . Avoid direct sunlight or extremely changes of the temperature.
3. For safety sake, do not disseminate the unit or put it on an unstable base. Do not drop it and avoid heavy impact.
4. Ventilation: Openings in the enclosure are provided for ventilation and to ensure reliable operation of the unit and to protect it from overheating. These openings must not be blocked or covered. This unit should not be placed in a built-in installation unless proper ventilation is provided.
5. Cleanse: Unplug the unit from the outlet before cleansing. Do not use liquid cleaners or aerosol cleaners. Use a damp cloth to clean it.
6. Overload: Do not overload outlets and extension cords as this may result in a risk of fire or electric shock.
7. Object and Liquid Entry: Never push objects of any kind into this unit through openings as they may touch dangerous voltage points or short-out parts that could result in a fire or electric shock. Never spill liquid of any kind on the unit.
8. Service: Do not attempt to service this unit yourself as opening or removing covers may expose you to dangerous voltage of other hazards. Refer all servicing to qualified service personnel.

## II. Features

<b>Screen size:</b>	5.6 inch., 116 (H) x 87 (V) mm.
<b>Active area:</b>	111.36 (H) x 83.52 (V) mm
<b>Drive system:</b>	A-Si TFT active matrix
<b>Screen color:</b>	Full-Color
<b>Dot matrix:</b>	320 (H) x RGB x 240 (V) dots
<b>Dot pitch:</b>	0.116 (H) x 0.348 (V)
<b>Overall dimension:</b>	162 (H) x 133 (V) x 54 (D)
<b>Contract ratio:</b>	85:1
<b>Luminosity:</b>	270 cd/m <sup>2</sup>
<b>Sound output:</b>	200mW x build in 4cm speaker 1 piece
<b>Input terminals:</b>	Power input, Video input, Audio input
<b>Consumption power:</b>	DC 12V/600mA, 8W (MAX)
<b>Power input:</b>	DC 9V ~ 20V, pin 2.0 $\phi$
<b>Video input:</b>	0.75 V <sub>p-p</sub> ~ 1V <sub>p-p</sub> , pin 3.5 $\phi$
<b>Audio input:</b>	50mV.(min), Stereo in, pin 3.5 $\phi$
<b>Stereo output:</b>	Ear phone, pin 3.5 $\phi$
<b>Screen Display:</b>	Reverse / Normal switchable (R $\leftrightarrow$ N)
<b>Operate temperature:</b>	-40°C ~ +95°C

# III. Function of Controllers

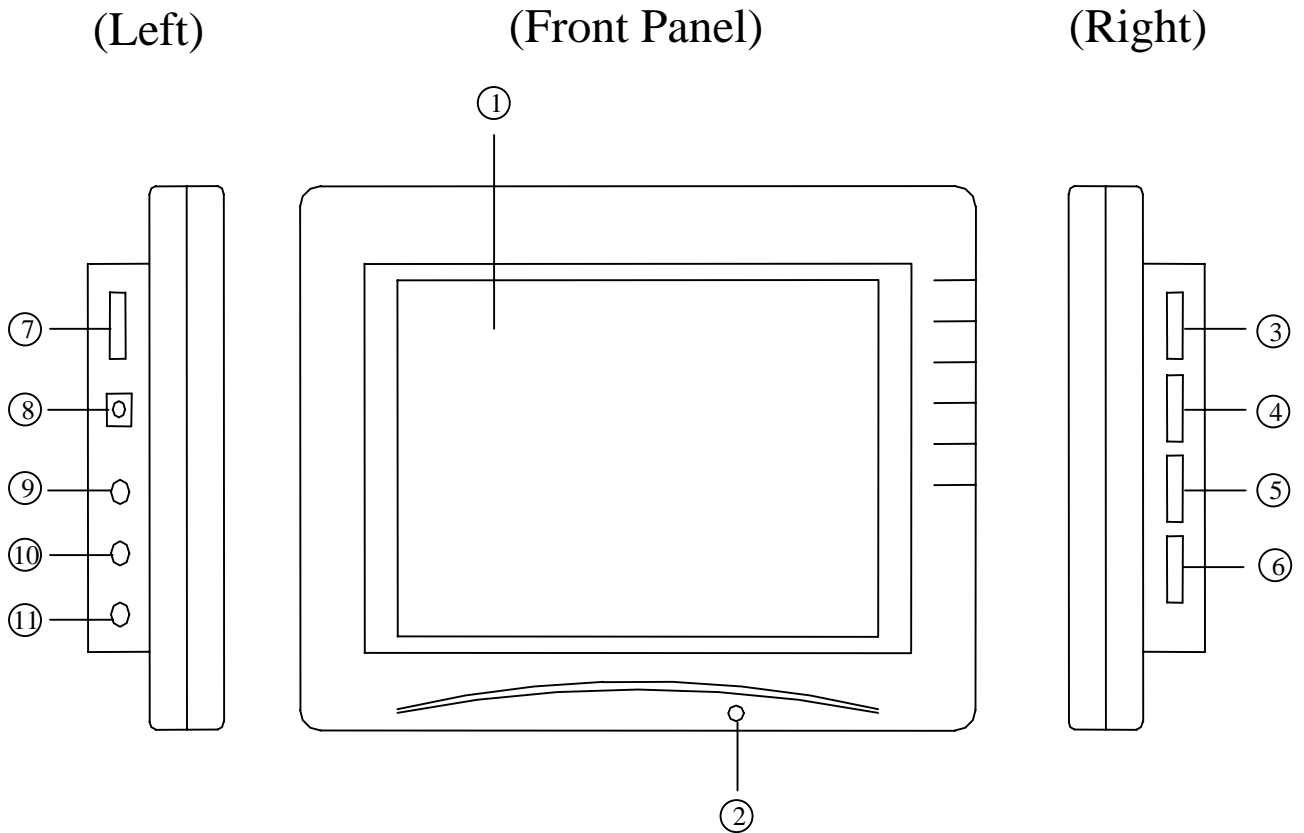

- ① 5.6" TFT Color Screen Display
- ② Power LED (Green)
- ③ Brightness Adjustment
- ④ Contrast Adjustment
- ⑤ Color Adjustment
- ⑥ Audio Volume Adjustment
- ⑦ Power ON/OFF
- ⑧ DC 12V Power Input
- ⑨ Video Input
- ⑩ Earphone Audio Output
- ⑪ Audio Input

### (Rear Panel)

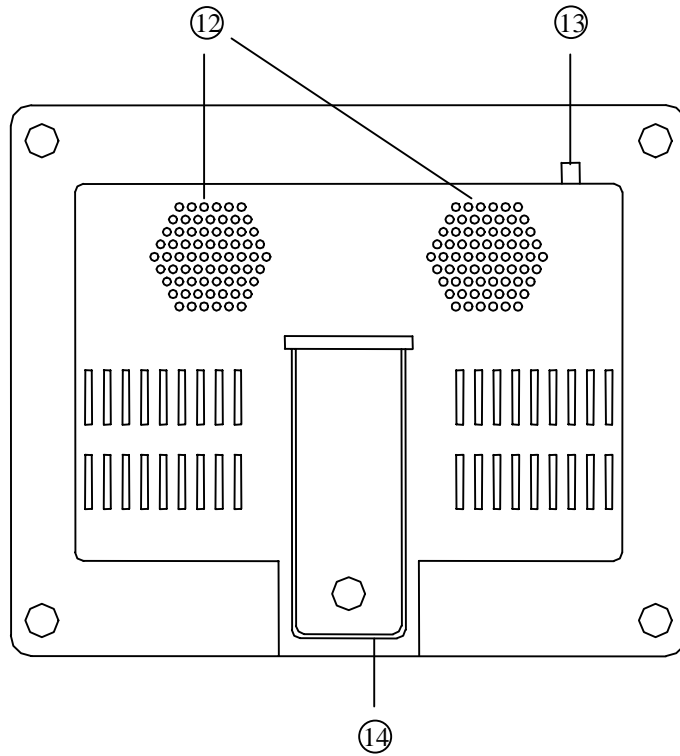

- ⑫ Speaker output 200mW
- ⑬ Reverse / Normal switch for screen display
- ⑭ Incline Supporter

# IV. Operation

## 1. Power:

- a. Power source: DC 12V
- b. AC adapter: DC 12V, 1000mA
- c. Battery: DC 12V

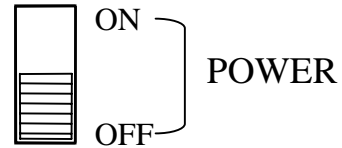

## 2. Viewing Angle:

The ideal viewing angle is within the following range:

- a. Upper angle:  $30^{\circ}$
- b. Lower angle:  $10^{\circ}$
- c. Left angle:  $45^{\circ}$
- d. Right angle:  $45^{\circ}$

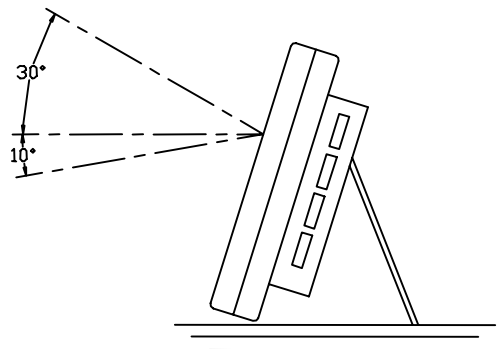

## 3. Connection:

- a. Video input
- b. Earphone audio output
- c. Audio input

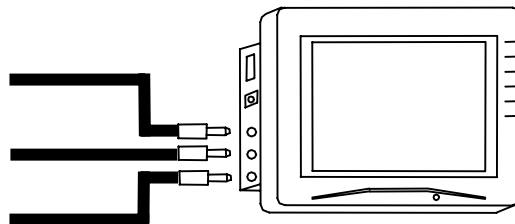

# V. Adjustment

## 1. Brightness Adjustment:

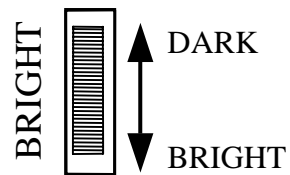

## 2. Contrast Adjustment:

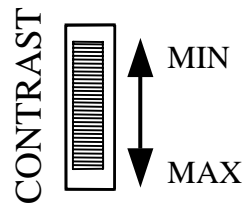

## 3. Color Adjustment:

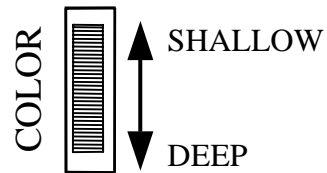

## 4. Audio Volume Adjustment:

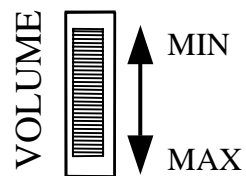

## 5. N/R Switcher:

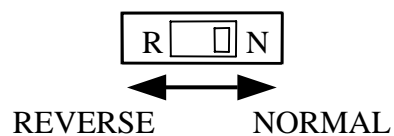

## ***EverFocus Electronics Corp.***

Head Office:

10F-6, No.79 Sec. 1 Shin-Tai Wu Road,  
Hsi-Chi, Taipei, Taiwan

TEL : 886-2-26982334

FAX : 886-2-26982380

USA Office:

Suite 101-102, 2975 Huntington Drive  
San Marino, CA. 91108

U.S.A.

TEL : (626) 844-8888

FAX : (626) 844-8838

Toll free : 1-(888) 383-6287 or  
1-(888) EV-FOCUS



***EverFocus***

P/N : MEN2G00200