

ZXRE125

SOT23 MICROPOWER 1.22V VOLTAGE REFERENCE

DESCRIPTION

The ZXRE125 is a bandgap circuit designed to achieve a precision micropower voltage reference of 1.22 volts. The device is available in the small outline SOT23 surface mount package which is ideal for applications where space saving is important.

SOT23 tolerance is available to 0.5% for precision applications. Excellent performance is maintained over the 30 μ A to 5mA operating current range with a

typical temperature coefficient of only 20ppm/ $^{\circ}$ C. The device has been designed to be highly tolerant of capacitive loads so maintaining excellent stability.

This device offers a SOT23 pin for pin compatible replacement of the ZRA124 and ZRA125 series of voltage references. SO8 and E-Line (TO92 style) packages can also be made available.

FEATURES

- High performance replacement for ZRA124 and ZRA125 references
- Small outline SOT23
- SO8 and E-Line alternatives available
- 30 μ A knee current
- 20ppm/ $^{\circ}$ C typical temperature coefficient
- Unconditionally stable
- 0.5%, 1%, 2% and 3% tolerance
- Contact Zetex marketing for availability of tighter tolerance devices

- Battery powered equipment
- Precision power supplies
- Portable instrumentation
- Portable communications devices
- Notebook and palmtop computers
- Data acquisition systems
- A/D and D/A converters
- Test equipment

SCHEMATIC DIAGRAM

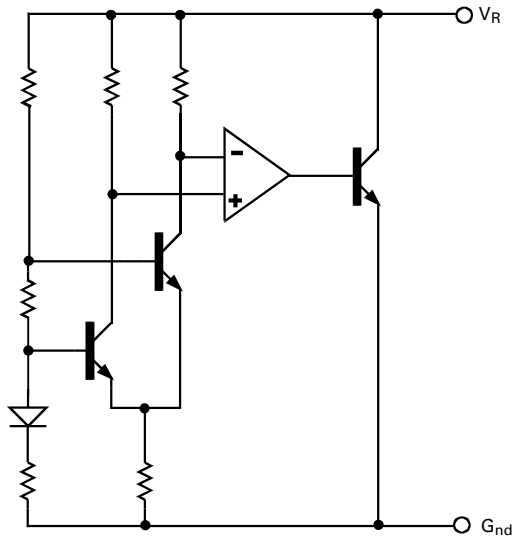

APPLICATIONS CIRCUIT

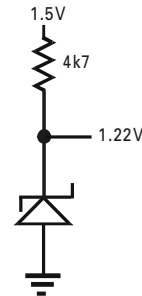

Low quiescent reference from a 1.5V battery source.

APPLICATIONS

ISSUE 4 - JANUARY 2002



ZXRE125

ABSOLUTE MAXIMUM RATINGS

Reverse Current	30mA
Forward Current	10mA
Operating temperature.	-40 to 85°C
Storage temperature.	-55 to 125°C

Power Dissipation ($T_{amb}=25^{\circ}\text{C}$)	
SOT23	330mW
SO8	625mW
E-Line	500mW

ELECTRICAL CHARACTERISTICS

TEST CONDITIONS (Unless otherwise stated) $T_{amb}=25^{\circ}\text{C}$

SYMBOL	PARAMETER	CONDITIONS	LIMITS			TOL. %	UNITS
			MIN	TYP	MAX		
V_R	Reverse Breakdown Voltage	$I_R=100\mu\text{A}$	1.214 1.208 1.196 1.183	1.22 1.22 1.22 1.22	1.226 1.232 1.244 1.257	0.5 ‡ 1 2 3	V
I_{MIN}	Minimum Knee Current				30		μA
I_R	Recommended Operating Current Range		0.03		5		mA
T_C †	Average Reverse Breakdown Voltage Temperature Coefficient	$I_{R(min)}$ to $I_{R(max)}$		20	90		ppm/ $^{\circ}\text{C}$
$\frac{\Delta V_R}{\Delta I_R}$	Reverse Breakdown Voltage change with Current	$I_R=30\mu\text{A}$ to 1mA $I_R=1\text{mA}$ to 5mA			1 10		mV mV
Z_R	Reverse Dynamic Impedance	$I_R = 1\text{mA}$ $f = 100\text{Hz}$ $I_{AC}=0.1 I_R$		0.2	0.6		Ω
E_N	Wideband Noise Voltage	$I_R=8\mu\text{A}$ to $100\mu\text{A}$ $f=10\text{Hz}$ to 10kHz		60			$\mu\text{V(rms)}$

$$\dagger T_C = \frac{(V_{R(max)} - V_{R(min)}) \times 1000000}{V_R \times (T_{(max)} - T_{(min)})}$$

Note: $V_{R(max)} - V_{R(min)}$ is the maximum deviation in reference voltage measured over the full operating temperature range.
‡ Note: 0.5% SOT23 only.

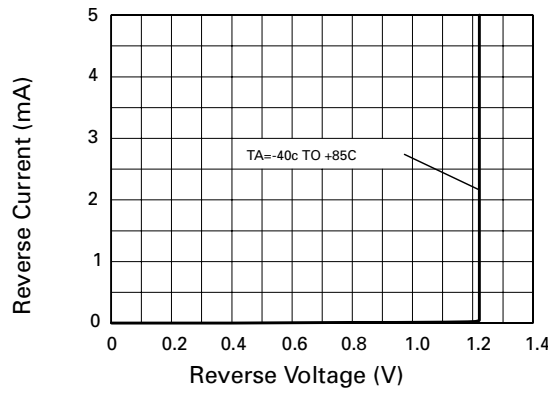

Reverse Characteristics



ISSUE 4 - JANUARY 2002

TYPICAL CHARACTERISTICS

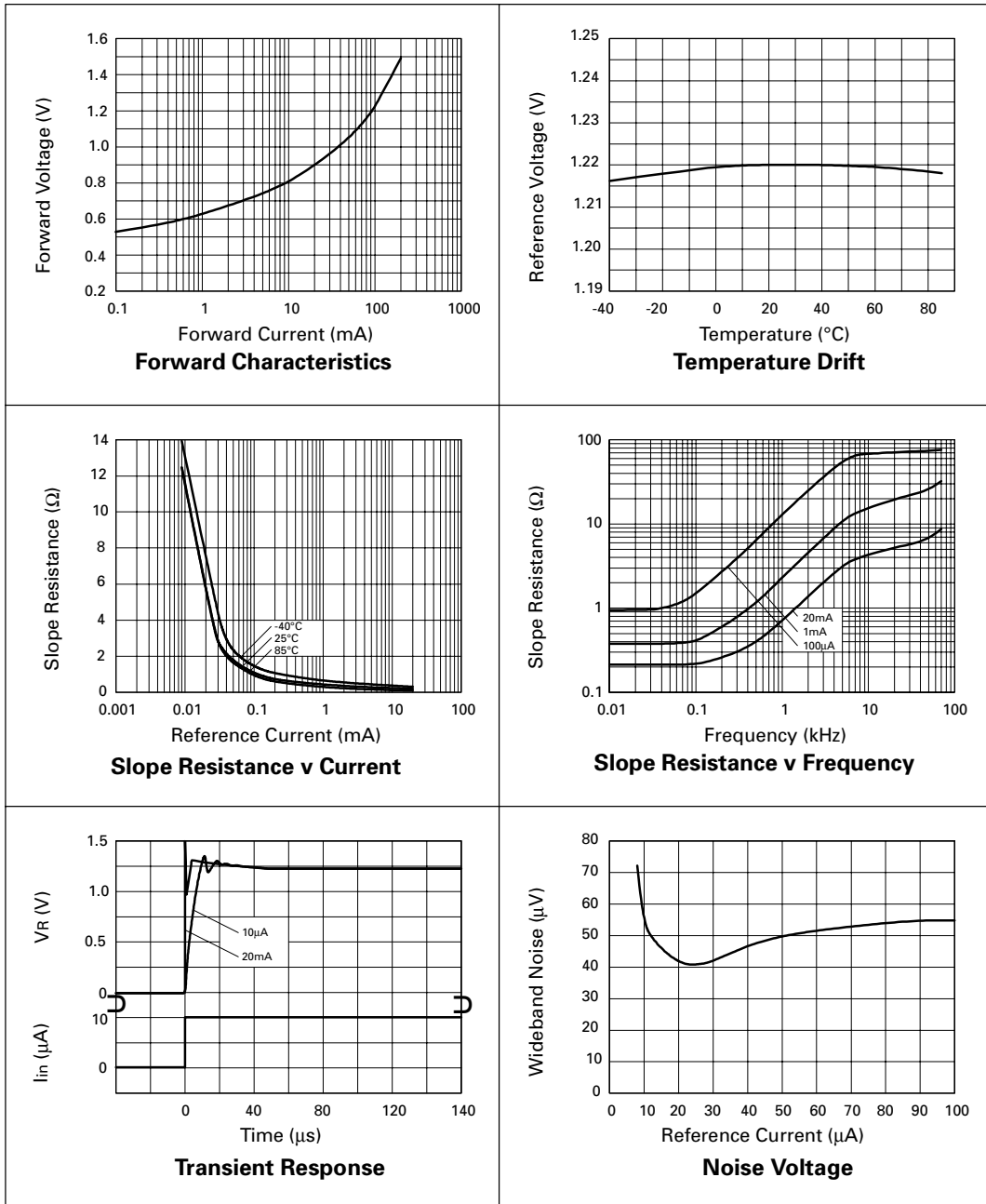

ZXRE125

Ordering Information

Device	TOL%	Package	Partmarking
ZXRE125CF	0.5	SOT23	12J
ZXRE125DF	1	SOT23	12H
ZXRE125EF	2	SOT23	12G
ZXRE125FF	3	SOT23	12F
ZXRE125DN8	1	SO8	ZXRE125D
ZXRE125EN8	2	SO8	ZXRE125E
ZXRE125FN8	3	SO8	ZXRE125F
ZXRE125DR	1	E-Line	ZXRE125D
ZXRE125ER	2	E-Line	ZXRE125E
ZXRE125FR	3	E-Line	ZXRE125F

NOTE:

For tape and reel options add suffix TA to the part number
eg ZXRE125DFTA

Connection Diagrams

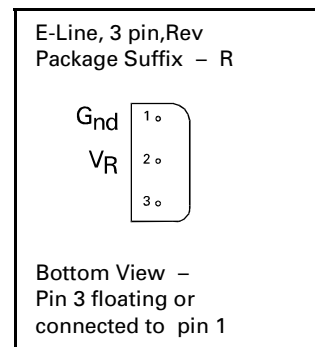
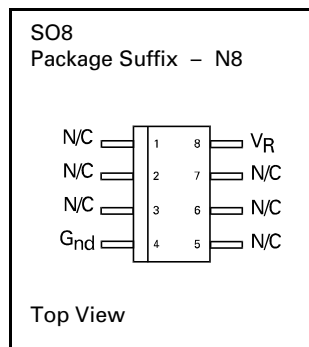
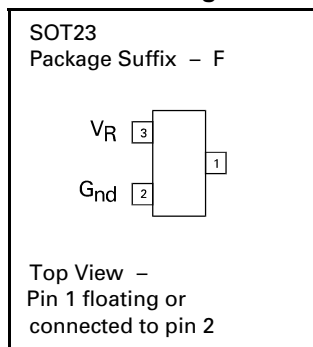

Zetex plc.
Fields New Road, Chadderton, Oldham, OL9-8NP, United Kingdom.
Telephone: (44)161 622 4422 (Sales), (44)161 622 4444 (General Enquiries)
Fax: (44)161 622 4420

Zetex GmbH
Streitfeldstraße 19
D-81673 München
Germany
Telephone: (49) 89 45 49 49 0
Fax: (49) 89 45 49 49 49

Zetex Inc.
47 Mall Drive, Unit 4
Commack NY 11725
USA
Telephone: (631) 543-7100
Fax: (631) 864-7630

Zetex (Asia) Ltd.
3701-04 Metroplaza, Tower 1
Hing Fong Road,
Kwai Fong, Hong Kong
Telephone: (852) 26100 611
Fax: (852) 24250 494

These are supported by
agents and distributors in
major countries world-wide
©Zetex plc 2001

<http://www.zetex.com>

This publication is issued to provide outline information only which (unless agreed by the Company in writing) may not be used, applied or reproduced for any purpose or form part of any order or contract or be regarded as a representation relating to the products or services concerned. The Company reserves the right to alter without notice the specification, design, price or conditions of supply of any product or service.

ISSUE 4 - JANUARY 2002