

# BALDOR MN430 Explosion Proof Motors Manual

<http://www.manuallib.com/baldor/mn430-explosion-proof-motors-manual.html>

This document is a supplement to the Baldor Installation and Operation Manual MN408. MN408 contains general procedures that apply to NEMA/IEC type Baldor Motor products (hereinafter referred to as “the Motors”). For your protection, do not install, operate or attempt to perform maintenance procedures until you understand the WARNING and Caution statements.

ManualLib.com collects and classifies the global product instruction manuals to help users access anytime and anywhere, helping users make better use of products.

<http://www.manuallib.com>

**BALDOR • RELIANCE**

---

---

---

**Explosion Proof Motors  
NEMA 180-449 (IEC 112S-280H)**

**Installation & Operating Manual**

Any trademarks used in this manual are the property of their respective owners.

# Table of Contents

---

<b>Section 1</b>	
<b>General Information</b> .....	1-1
Introduction .....	1-1
Safety Notice .....	1-6
Receiving .....	1-8
Handling .....	1-9
Storage .....	1-9
Preparation for Storage .....	1-9
Removal From Storage .....	1-10
Warranty .....	1-10
<b>Section 2</b>	
<b>Installation &amp; Operation</b> .....	2-1
Installation and use .....	2-1
Mounting .....	2-1
Frame Mounting Holes .....	2-2
Alignment .....	2-2
Doweling & Bolting .....	2-2
Guarding .....	2-3
Connection of AC Power Supply .....	2-3
Connection of Additional Devices .....	2-4
Options of Rotation Control (Direction and Speed) .....	2-4
Connection Diagrams .....	2-5
Lubrication Procedure .....	2-7
Start-up and Commencement Of Operation of Electrical Motors .....	2-7
First Time Start Up .....	2-7
Coupled Start Up .....	2-7
Jogging and Repeated Starts .....	2-7
Repair .....	2-8
<b>Section 3</b>	
<b>Maintenance &amp; Troubleshooting</b> .....	3-1
General Inspection .....	3-1
Relubrication & Bearings .....	3-1
Type of Grease .....	3-1
Relubrication Intervals .....	3-2
Relubrication Procedure .....	3-3
Troubleshooting Chart .....	3-5
Suggested bearing and winding RTD setting guidelines for Non-Hazardous Locations ONLY .....	3-6
<b>Appendix A</b> .....	A-1



# Section 1

## General Information

---

### Introduction

This document is a supplement to the Baldor Installation and Operation Manual MN408. MN408 contains general procedures that apply to NEMA/IEC type Baldor Motor products (hereinafter referred to as “the Motors”). For your protection, do not install, operate or attempt to perform maintenance procedures until you understand the **WARNING** and **Caution** statements.

Before you install, operate or perform maintenance, become familiar with the following documents (with regard for specific application area:

GOST R IEC 60079-0:2007	Explosive atmospheres. Part 0. Equipment. General requirements.
GOST R 52350.19:2007 (IEC 60079-19:2006)	Explosive atmospheres. Equipment repair, overhaul and reclamation.
GOST 12.1.030-81	Occupational safety standards system. Electric safety. Protective grounding. Neutral grounding.
GOST 21130-75	Electrical devices. Earth terminals and earth signs.
PB 05-618-03	Safety rules in coal mines.
PB 03-553-03	Uniform safety rules for the development of ore, non-metallic minerals and placer deposits of minerals by underground technique.
PB 08-624-03	Safety rules in the oil and gas industry.
PB 09-540-03	General explosion safety rules for explosion-fire hazard chemical, petrochemical and oil refining industries.
PTE	Electrical equipment operating instructions. Approved by Order No. 6 of the Ministry of Energy of the Russian Federation dated January 13, 2003.
PUE	Installation requirements for electrical equipment and installations. Approved by Order No. 204 of the Ministry of Energy of the Russian Federation dated July 08, 2002.

### I Description & Operation

#### I.1 Product Description & Operation

##### I.1.1 Product Scope of Application

NEMA/IEC motors are used as power elements of the electric drives.

NEMA/IEC motors have explosion-proof performance for three groups, i.e., I, II (subgroup IIB), and III (according to GOST R IEC 60079-0:2007).

Scope of application:

- Underground coal mines and pits and their above-ground buildings which are hazardous for firedamp and/or combustible dust according to the explosion protection marking (group I motors);
- Class 1 and 2 explosive zones of the buildings and outdoor installations according to the explosion protection marking (group II motors);
- Zones hazardous for ignition of combustible dust of classes 21 and 22 according to the explosion protection marking (group III motors).

Primary technical items for installing NEMA/IEC motors of group I:

- Pumps; - Conveyors; - Fans; - Roof bolter;
- Drives for cutting, crushing, and grinding; - Travel drives.

Primary technical items for installing NEMA/IEC motors of group II:

- Pumps; - Turbine starters; - Valve, shutter, and damper actuators; - Fans.

Primary technical items for installing NEMA/IEC motors of group III:

- Conveyors; - Drives for cutting, crushing, and grinding - Fans;.

##### I.1.2 Technical parameters

NEMA 180-440 frame range motors (IEC equivalent designations 112S-280H) have the following specifications:

###### I.1.2.1 Levels and types of explosion protection

For NEMA/IEC motors of Group I – **Ex d I Mb X**;

For NEMA/IEC motors of Group II (subgroup IIB) – **Ex d IIB Gb T3...T4...T5 X**; **Ex d e IIB Gb T3...T4...T5 X**;

For NEMA/IEC motors of Group III –  
 - Ex t IIIC T100°C ... T135°C... T200°C Db X IP6X.

**I.1.2.2 Ingress protection according to GOST 14254-96**

For NEMA/IEC motors of Group I and For NEMA/IEC motors of Group II (subgroup IIB) – IP54, or higher.  
 For NEMA/IEC motors of Group III – IP6X.

**I.1.2.3 Electrical products group of guard against personnel electrical shock according to GOST 12.2.007.0-75**

**I.1.2.4 Ambient temperature range**

Ambient temperature range for NEMA/IEC motors is –20 ... +65°C.

**I.1.2.5 Maximum supply voltage**

Maximum AC supply voltage is 7200 V.

Power can be supplied directly from an electrical outlet or via an inverter.

**I.1.2.6 Nominal rating power**

Values of long nominal rating power are presented in Table 1–1.

**Table 1–1**

Frame	Long nominal rating power
180 [180T, 184T] / (112, 112S, 112M)	7.5
210 [210T, 213T, 215T] / (132, 132S, 132M)	15.0
250 [250T, 254T, 256T] / (160, 160M, 160L)	22.5
280 [280T, 284T, 284TS, 286T, 286TS] / (180, 180M, 180L)	37.5
320 [320T, 324T, 324TS, 326T, 326TS] / (200, 200S, 200M, 200L)	56.2
360 [360T, 364T, 364TS, 365T, 365TS] / (225, 225S, 225M)	93.7
400 [400T, 404T, 404TS, 405T, 405TS] / (250, 250S, 250M)	111.8
440-449 [440T, 444T, 444TS, 445T, 445TS, 447T, 447TS, 449T, 449TS] / (280, 280S, 280H)	372.9

**I.1.3 Construction and operation**

Each motor has a cast iron frame which is bolted down along with the cast iron cover and iron end bracket. The rotor and stator are inside the casing. The rotor is connected with a shaft that is carried by bearings. Overall view is given at Figure 1-1.

A fan made of cast iron or steel is mounted from the side of the cast iron cover. A heater may be placed around stator winding as additional equipment for preventing condensate accumulation. The heater is stopped when the motor operates.

Only certified explosion-proof (Ex-certified) cable entries are used.

**Structural additions**

- 1) Inlet box made of cast iron and enclosed with a cover on the side of which are installed the certified explosion-proof cable entries.
- 2) Drain port threaded into the end shield and spiral wrap around shaft.
- 3) Protective casing for fan at vertical installation of the motor.
- 4) Adaptation for use of the motor as an electric generator.
- 5) Installation of cooling fans according to Tables 1–2 and 1–3.
- 6) Temperature switch installed on two windings of the stator. Temperature class is determined by the availability or unavailability of the switch (see Table 1–3).

**Table 1–2 Additional Design of Group I Explosion-Proof Fans.**

Supply voltage	Fan	Thermostatic Switch
line-fed	installed	not connected
line-fed	installed	connected
line-fed	not installed	connected
from frequency converter	not installed	connected
from frequency converter	installed	connected

Figure 1-1

FLAMEPROOF ENCLOSURE 'd'

GROUP I / IIB PER 60079-0 AND IEC 60079-1

SIRA CERTIFICATE No's.

SIRA 09ATEX1037X  
IECEx SIR 09.0011X

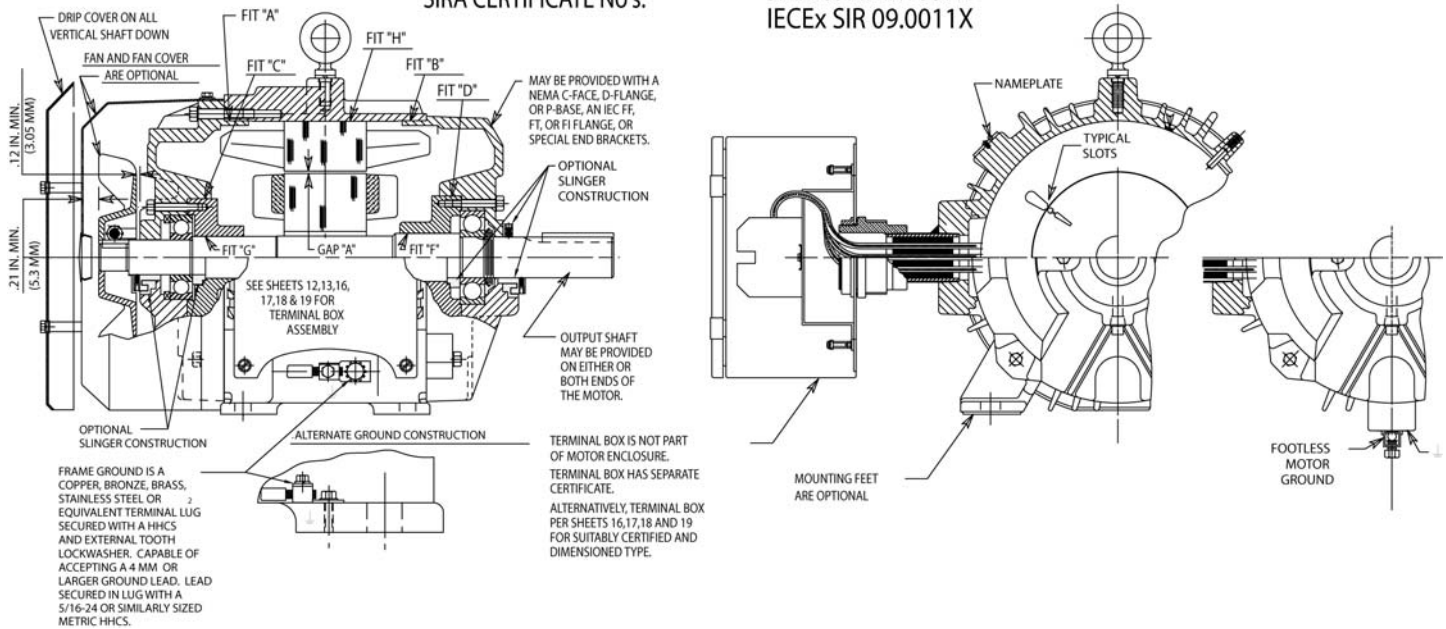

Table 1-3 Additional Design of Group II (Subgroup IIB) and III Explosion-Proof Fans.

Supply voltage	Fan	Thermostatic Switch	Temperature Class for Equipment Protection Level Gb	Temperature Class for Equipment Protection Level Db
line-fed	installed	not connected	T4	T135°C
line-fed	installed	connected		
line-fed	not installed	connected	T3, T4 or T5	T200°C, T135°C, or T100°C
from frequency converter	not installed	connected		
from frequency converter	installed	connected		

There are structural elements on the motor casing for attachment of the certified explosion-proof inlet box. The inlet box shall have two compartments and be equipped with certified explosion-proof cable entries. Motors for group I shall be equipped with inlet box with two compartments and cable entries having explosion protection type *d*.

Cable entry can be filled with compound. In this case it shall be specially marked.

Possible options for inlet box design:

- Inlet box combined with the motor shell;
- Cylindrical inlet box;
- Quadrangular inlet box;
- Inlet box with internal cavity isolated from the motor shell internal cavity (used only for the motors of Group I).

1.1.4 Marking

NEMA/ IEC motors marking (see Figure 1-2A, B, C and D) includes:

- Name and brand mark of the company **Baldor Electric Company**;
- Name and nominal size of the motor;
- Serial number;
- Name or certification authority sign and certificate number;
- Explosion protection marking: for NEMA/ IEC motors of group I – Ex d I Mb X;
- For NEMA motors of group II (subgroup IIB) – Ex d IIB Gb T\* X; Ex d e IIB Gb T\* X;



- For NEMA motors of group III -- Ex t IIIC T\*°C Db X IP6X;
- Warning plate: **CAUTION: OPEN AFTER DISCONNECTION FROM MAINS SUPPLY;**
- Ambient temperature range;
- Required electrical parameters.
- \* Note: Interpreted as per data of Table 1–3.

**Figure 1-2 Nameplates** (see also Appendix A)

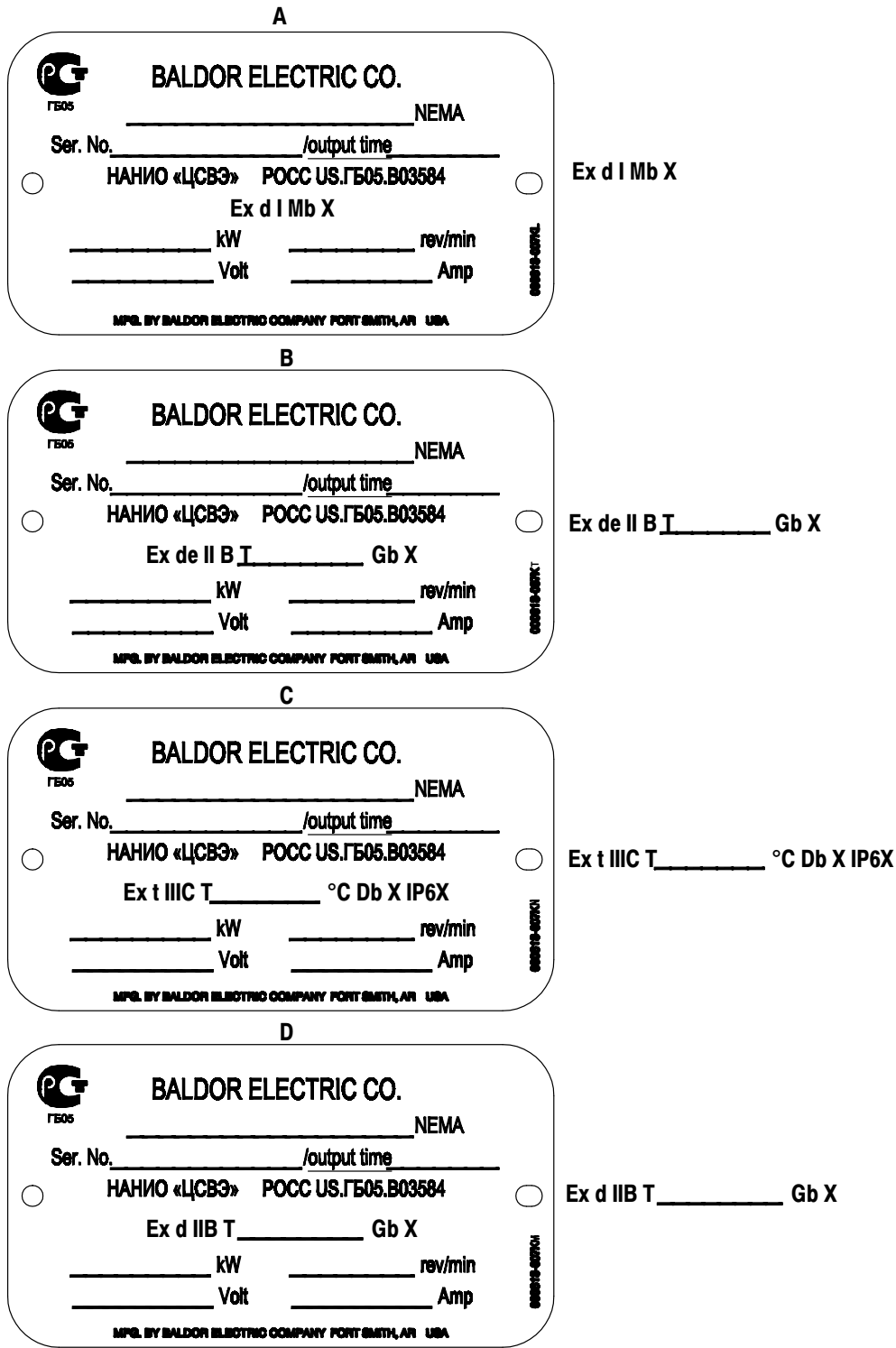

---

## II Intended use

### II.1 Operating limits

#### II.1.1 Conditions of use

Special conditions for ensuring operational safety, marked with an 'X' placed after explosion protection marking indicates that at operation of explosion protected motors of types NEMA 180-449 /(IEC 112S-280H) it is necessary to observe the following safety requirements:

- 6.1. The motors shall be equipped either with corresponding inlet boxes of Baldor Electric Company manufacture or other explosion protected boxes of corresponding design and certified as per GOST R with marking that corresponds to motors explosion protection marking.
- 6.2. The motor design shall correspond to the temperature class specified in markings according to the Tables 1–2 and 1–3.
- 6.3. The motors shall be used with GOST R certified explosion protected cable entries with explosion protection marking corresponding to the motors explosion protection marking. The cable entries dimensions shall comply with Table 1–4.

**Table 1–4**

Nominal Diameter of a Cable Entry, mm	Maximum Diameter of a Hole, mm	Minimum Diameter of a Sealing Ring, mm	Minimum Required Length of a Sealing Ring, mm
50.8	50.88	50.73	25
63.5	63.58	63.43	25
69.9	60.9	60.75	25
76.2	76.28	76.13	25
95.3	95.33	95.18	25
108	108.03	107.88	25
114	114.38	114.13	25

Threads must have a minimum of five full threads engagement and 8 mm axial length and shall correspond to: M20 x 1.5; M25 x 1.5; M32 x 1.5; M40 x 1.5; M50 x 1.5; M63 x 1.5; M75 x 1.5; M90 x 2; M100 x 2.

#### II.1.2 Supply from frequency converter

If the motor is evaluated for operation with an adjustable speed drive, the type of converter (for example PWM for Pulse Width Modulated) and safe speed ranges (for example 0-120Hz) will be specified in the certification documents or on motor nameplates. It is necessary to consult the adjustable speed drive manual for proper set up.

#### II.1.3 Earthing

In making the ground connection, the installer should make certain that there is a solid and permanent metallic connection between the ground point, the motor or generator terminal housing, and the motor or generator frame. The implementation of earthing shall meet the GOST 12.1.030-81 and GOST 21130-75 requirements.

Motors with resilient cushion rings usually must be provided with a bonding conductor across the resilient member. Some motors are supplied with the bonding conductor on the concealed side of the cushion ring to protect the bond from damage. Motors with bonded cushion rings should usually be grounded at the time of installation in accordance with the above recommendations for making ground connections. When motors with bonded cushion rings are used in multimotor installations employing group fusing or group protection, the bonding of the cushion ring should be checked to determine that it is adequate for the rating of the branch circuit over current protective device being used. There are applications where grounding the exterior parts of a motor or generator may result in greater hazard by increasing the possibility of a person in the area simultaneously contacting ground and some other nearby live electrical parts of other ungrounded electrical equipment. In portable equipment it is difficult to be sure that a positive ground connection is maintained as the equipment is moved, and providing a grounding conductor may lead to a false sense of security.

Select a motor starter and over current protection suitable for this motor and its application. Consult motor starter application data as well as the National Electric Code and/or other applicable local codes.

For motors installed according to GOST R IEC 60079-0–2007 requirements, protection cables shall have the following cross-section area (see Table 1–5):

**Table 1-5**

Cross-Sectional Area of Phase Lead,	Minimum Cross-Sectional Area of Corresponding Protective Conductor, $S_p$ , mm <sup>2</sup>
$S < 16$	S
$16 < S \leq 35$	16
$S > 35$	0.5 S

Equipotential bonding connection shall be made using a conductor with a cross-sectional area of at least 4 mm<sup>2</sup>.

**II.1.4 Limits of use**

- Safety Notice:** This equipment contains high voltage! Electrical shock can cause serious or fatal injury. Only qualified personnel should attempt installation, operation and maintenance of electrical equipment. Be sure that you are completely familiar with NEMA publication MG-2, safety standards for construction and guide for selection, installation and use of electric motors and generators, the National Electrical Code and local codes and practices. Unsafe installation or use can cause conditions that lead to serious or fatal injury. Only qualified personnel should attempt the installation, operation and maintenance of this equipment.
- WARNING:** Do not touch electrical connections before you first ensure that power has been disconnected. Electrical shock can cause serious or fatal injury. Only qualified personnel should attempt the installation, operation and maintenance of this equipment.
- WARNING:** Disconnect all electrical power from the motor windings and accessory devices before disassembly of the motor. Electrical shock can cause serious or fatal injury.
- WARNING:** Be sure the system is properly grounded before applying power. Do not apply AC power before you ensure that all grounding instructions have been followed. Electrical shock can cause serious or fatal injury. National Electrical Code and Local codes must be carefully followed.
- WARNING:** Avoid extended exposure to machinery with high noise levels. Be sure to wear ear protective devices to reduce harmful effects to your hearing.
- WARNING:** Avoid the use of automatic reset devices if the automatic restarting of equipment can be hazardous to personnel or equipment.
- WARNING:** Surface temperatures of motor enclosures may reach temperatures which can cause discomfort or injury to personnel accidentally coming into contact with hot surfaces. When installing, protection should be provided by the user to protect against accidental contact with hot surfaces. Failure to observe this precaution could result in bodily injury.
- WARNING:** Water Cooled Motors with S2 30 minute rating without coolant flow are thermally protected. It is intended that this duty and operation will permit repositioning of equipment in circumstances where interruption of coolant flow may be necessary. To ensure all motors do not exceed the maximum permissible surface temperature for Group I equipment according to GOST R IEC 60079-0:2007 they must be operated according to the duty cycle. In addition, it is critical the installation, use and maintenance allow free flow of air around the motors. Build-up of material such as coal dust that could also inhibit circulation must be removed before operation with this duty cycle. In addition, it is necessary to connect the motor thermal protection devices which act as a secondary measure to provide additional assurance that the permissible maximum surface temperature is not exceeded.
- WARNING:** Motors must only be serviced by a Baldor authorized certified service centers in accordance with the requirements of GOST R 52350.19:2007 (IEC 60079-19:2006).
- WARNING:** Do not use non certified (PB 03-538-03) explosion proof motors in the presence of flammable or combustible vapors or dust. These motors are not designed for atmospheric conditions that require explosion proof operation.
- WARNING:** This equipment may be connected to other machinery that has rotating parts or parts that are driven by this equipment. Improper use can cause serious or fatal injury. Only qualified personnel should attempt to install operate or maintain this equipment.
- WARNING:** Do not by-pass or disable protective devices or safety guards. Safety features are designed to prevent damage to personnel or equipment. These devices can only provide protection if they remain operative.

---

**Safety Notice** Continued

- WARNING:** Be sure the load is properly coupled to the motor shaft before applying power. The shaft key must be fully captive by the load device. Improper coupling can cause harm to personnel or equipment if the load decouples from the shaft during operation.
- WARNING:** UL Listed motors must only be serviced by UL Approved Authorized Baldor Service Centers if these motors are to be returned to a hazardous and/or explosive atmosphere.
- WARNING:** Thermostat contacts automatically reset when the motor has slightly cooled down. To prevent injury or damage, the control circuit should be designed so that automatic starting of the motor is not possible when the thermostat resets.
- WARNING:** Use proper care and procedures that are safe during handling, lifting, installing, operating and maintaining operations. Improper methods may cause muscle strain or other harm.
- WARNING:** Pacemaker danger – Magnetic and electromagnetic fields in the vicinity of current carrying conductors and permanent magnet motors can result result in a serious health hazard to persons with cardiac pacemakers, metal implants, and hearing aids. To avoid risk, stay way from the area surrounding a permanent magnet motor.
- WARNING:** Before performing any motor maintenance procedure, be sure that the equipment connected to the motor shaft cannot cause shaft rotation. If the load can cause shaft rotation, disconnect the load from the motor shaft before maintenance is performed. Unexpected mechanical rotation of the motor parts can cause injury or motor damage.
- WARNING:** Do not use non UL/CSA listed explosion proof motors in the presence of flammable or combustible vapors or dust. These motors are not designed for atmospheric conditions that require explosion proof operation.
- WARNING:** Motors that are to be used in flammable and/or explosive atmospheres must display the UL label on the nameplate along with CSA listed logo. Specific service conditions for these motors are defined in NFPA 70 (NEC) Article 500.
- WARNING:** Guards must be installed for rotating parts such as couplings, pulleys, external fans, and unused shaft extensions, should be permanently guarded to prevent accidental contact by personnel. Accidental contact with body parts or clothing can cause serious or fatal injury.
- Caution:** To prevent premature equipment failure or damage, only qualified maintenance personnel should perform maintenance.
- Caution:** Do not over tension belts. Excess tension may damage the motor or driven equipment.
- Caution:** Do not over-lubricate motor as this may cause premature bearing failure.
- Caution:** Do not lift the motor and its driven load by the motor lifting hardware. The motor lifting hardware is adequate for lifting only the motor. Disconnect the load (gears, pumps, compressors, or other driven equipment) from the motor shaft before lifting the motor.
- Caution:** If eye bolts are used for lifting a motor, be sure they are securely tightened. The lifting direction should not exceed a 20° angle from the shank of the eye bolt or lifting lug. Excessive lifting angles can cause damage.
- Caution:** To prevent equipment damage, be sure that the electrical service is not capable of delivering more than the maximum motor rated amps listed on the rating plate.
- Caution:** If a HI POT test (High Potential Insulation test) must be performed, follow the precautions and procedure in NEMA MG1 and MG2 standards to avoid equipment damage.
- Caution:** The space heaters are designed to operate at or below the maximum surface temperature stated on the nameplate. If the marked ambient and/or voltage are exceeded this maximum surface temperature can be exceeded and can damage the motor windings. If applied in a division 2 or zone 2 environment this excessive temperature may cause ignition of hazardous materials.

---

### **Sine Wave Power Operation for Division 1 or 2 and Zone 1 or 2 and Zone 21 or 22 Hazardous Location.**

These motors are designed to operate at or below the maximum surface temperature (or T-Code) stated on the nameplate. Failure to operate the motor properly can cause this maximum surface temperature to be exceeded. If applied in a Division 1 or 2 / Zone 1 or 2 and Zone 21 or 22 environment, this excessive temperature may cause ignition of hazardous materials. Operating the motor at any of the following conditions can cause the marked surface temperature to be exceeded.

1. Motor load exceeding service factor nameplate value
2. Ambient temperatures above nameplate value
3. Voltages above or below nameplate value
4. Unbalanced voltages
5. Loss of proper ventilation
6. Altitude above 3300 feet / 1000 meters
7. Severe duty cycles of repeated starts
8. Motor stall
9. Motor reversing
10. Single phase operation of polyphase equipment
11. Variable frequency operation

### **Variable Frequency Power Operation for Division 1 or 2 and Zone 1 or 2 and Zone 21 or 22 Hazardous Location** (motors with maximum surface temperature listed on the nameplate).

Only motors with nameplates marked for use on inverter (variable frequency) power, and labeled for specific hazardous areas may be used in those hazardous areas on inverter power. The motor is designed to operate at or below the maximum surface temperature (or T-Code) stated on the nameplate. Failure to operate the motor properly can cause this maximum surface temperature to be exceeded.

If applied in a Division 1 or 2 / Zone 1 or 2 and Zone 21 or 22 environment, this excessive temperature may cause ignition of hazardous materials. Operating the motor at any of the following conditions can cause the marked surface temperature to be exceeded.

1. Motor load exceeding service factor nameplate value
2. Ambient temperature above nameplate value
3. Voltage (at each operating frequency) above or below rated nameplate value
4. Unbalanced voltages
5. Loss of proper ventilation
6. Operation outside of the nameplate speed / frequency range
7. Altitudes above 3300 feet / 1000 meters
8. Single phase operation of polyphase equipment
9. Unstable current wave forms
10. Lower than name plate minimum carrier frequency

If you have any questions or are uncertain about any statement or procedure, or if you require additional information please contact your Baldor distributor or an Authorized Baldor Service Center.

### **Receiving**

Each Baldor Electric Motor is thoroughly tested at the factory and carefully packaged for shipment. When you receive your motor, there are several things you should do immediately.

1. Observe the condition of the shipping container and report any damage immediately to the commercial carrier that delivered your motor.
2. Verify that the part number of the motor you received is the same as the part number listed on your purchase order.

---

**Handling**

The motor should be lifted using the lifting lugs or eye bolts provided.

**Caution:**

**Do not lift the motor and its driven load by the motor lifting hardware. The motor lifting hardware is adequate for lifting only the motor. Disconnect the load (gears, pumps, compressors, or other driven equipment) from the motor shaft before lifting the motor.**

1. Use the lugs or eye bolts provided to lift the motor. Never attempt to lift the motor and additional equipment connected to the motor by this method. The lugs or eye bolts provided are designed to lift only the motor. Never lift the motor by the motor shaft or the hood of a WP11 motor.
2. To avoid condensation inside the motor, do not unpack until the motor has reached room temperature. (Room temperature is the temperature of the room in which it will be installed). The packing provides insulation from temperature changes during transportation.
3. When lifting a WP11 (Weather Proof Type 2) motor, do not lift the motor by inserting lifting lugs into holes on top of the cooling hood. These lugs are to be used for hood removal only. A spreader bar should be used to lift the motor by the cast lifting lugs located on the motor frame.
4. If the motor must be mounted to a plate with the driven equipment such as pump, compressor etc., it may not be possible to lift the motor alone. For this case, the assembly should be lifted by a sling around the mounting base. The entire assembly can be lifted as an assembly for installation.  
Do not lift the assembly using the motor lugs or eye bolts provided. Lugs or eye bolts are designed to lift motor only. If the load is unbalanced (as with couplings or additional attachments) additional slings or other means must be used to prevent tipping. In any event, the load must be secure before lifting. If the load is unbalanced (as with couplings or additional attachments) additional slings or other means must be used to prevent tipping. In any event, the load must be secure before lifting.

**Storage**

Storage requirements for motors and generators that will not be placed in service for at least six months from date of shipment.

Improper motor storage will result in seriously reduced reliability and failure. An electric motor that does not experience regular usage while being exposed to normally humid atmospheric conditions is likely to develop rust in the bearings or rust particles from surrounding surfaces may contaminate the bearings. The electrical insulation may absorb an excessive amount of moisture leading to the motor winding failure.

A wooden crate "shell" should be constructed to secure the motor during storage. This is similar to an export box but the sides & top must be secured to the wooden base with lag bolts (not nailed as export boxes are) to allow opening and closing many times without damage to the "shell".

**Minimum resistance of motor winding insulation shall comply with the requirements of Section 1.8.15 of PUE.**

**Preparation for Storage**

1. Some motors have a shipping brace attached to the shaft to prevent damage during transportation. The shipping brace, if provided, must be removed and stored for future use. The brace must be reinstalled to hold the shaft firmly in place against the bearing before the motor is moved.
2. Store in a clean, dry, protected warehouse where control is maintained as follows:
  - a. Shock or vibration must not exceed 2 mils maximum at 60 hertz, to prevent the bearings from brinelling. If shock or vibration exceeds this limit vibration isolation pads must be used.
  - b. Storage temperatures of 10°C (50°F) to 49°C (120°F) must be maintained.
  - c. Relative humidity must not exceed 60%.
  - d. Motor space heaters (when present) are to be connected and energized whenever there is a possibility that the storage ambient conditions will reach the dew point. Space heaters are optional.  
Note: Remove motor from containers when heaters are energized, reprotect if necessary.
3. Measure and record the resistance of the winding insulation (dielectric withstand) every 30 days of storage.
  - a. If motor insulation resistance decreases below the minimum resistance, contact your Baldor District office.
  - b. Place new desiccant inside the vapor bag and re-seal by taping it closed.
  - c. If a zipper-closing type bag is used instead of the heat-sealed type bag, zip the bag closed instead of taping it. Be sure to place new desiccant inside bag after each monthly inspection.
  - d. Place the shell over the motor and secure with lag bolts.

- 
4. Where motors are mounted to machinery, the mounting must be such that the drains and breathers are fully operable and are at the lowest point of the motor. Vertical motors must be stored in the vertical position. Storage environment must be maintained as stated in step 2.
  5. Motors with anti-friction bearings are to be greased at the time of going into extended storage with periodic service as follows:
    - a. Motors marked "Do Not Lubricate" on the nameplate do not need to be greased before or during storage.
    - b. Ball and roller bearing (anti-friction) motor shafts are to be rotated manually every 3 months and greased every 6 months in accordance with the Maintenance section of this manual.
    - c. Sleeve bearing (oil lube) motors are drained of oil prior to shipment. The oil reservoirs must be refilled to the indicated level with the specified lubricant, (see Maintenance). The shaft should be rotated monthly by hand at least 10 to 15 revolutions to distribute oil to bearing surfaces.
    - d. "Provisions for oil mist lubrication" – These motors are packed with grease. Storage procedures are the same as paragraph 5b.
    - e. "Oil Mist Lubricated" – These bearings are protected for temporary storage by a corrosion inhibitor. If stored for greater than 3 months or outdoor storage is anticipated, connected to the oil mist system while in storage. If this is not possible, add the amount of grease indicated under "Standard Condition" in Section 3, then rotate the shaft 15 times by hand.
  6. All breather drains are to be fully operable while in storage (drain plugs removed). The motors must be stored so that the drain is at the lowest point. All breathers and automatic "T" drains must be operable to allow breathing and draining at points other than through the bearings around the shaft. Vertical motors should be stored in a safe stable vertical position.
  7. Coat all external machined surfaces with a rust preventing material. An acceptable product for this purpose is Exxon Rust Ban # 392.
  8. Carbon brushes should be lifted and held in place in the holders, above the commutator, by the brush holder fingers. The commutator should be wrapped with a suitable material such as cardboard paper as a mechanical protection against damage.

#### **Non-Regreaseable Motors**

Non-regreaseable motors with "Do Not Lubricate" on the nameplate should have the motor shaft rotated 15 times to redistribute the grease within the bearing every 3 months or more often.

#### **All Other Motor Types**

Before storage, the following procedure must be performed.

1. Remove the grease drain plug, if supplied, (opposite the grease fitting) on the bottom of each bracket prior to lubricating the motor.
2. The motor with regreaseable bearing must be greased as instructed in Section 3 of this manual.
3. Replace the grease drain plug after greasing.
4. The motor shaft must be rotated a minimum of 15 times after greasing.
5. Motor Shafts are to be rotated at least 15 revolutions manually every 3 months and additional grease added every nine months (see Section 3) to each bearing.
6. Bearings are to be greased at the time of removal from storage.

#### **Removal From Storage**

1. Remove all packing material.
2. Measure and record the electrical resistance of the winding insulation resistance meter at the time of removal from storage. The insulation resistance must not be less than 50% from the initial reading recorded when the motor was placed into storage. A decrease in resistance indicates moisture in the windings and necessitates electrical or mechanical drying before the motor can be placed into service. If resistance is low, contact your Baldor District office.
3. Regrease the bearings as instructed in Section 3 of this manual.
4. Reinstall the original shipping brace if motor is to be moved. This will hold the shaft firmly against the bearing and prevent damage during movement.

#### **Warranty**

Manufacturer's warranty is 12 months or 18 months from date of shipment whichever occurs first.

## Section 2 Installation & Operation

### Installation and use

The motor should be lifted using the lifting lugs or eye bolts provided. Use the lugs or eye bolts provided to lift the motor. Never attempt to lift the motor and additional equipment connected to the motor by this method. The lugs or eye bolts provided are designed to lift only the motor. Never lift the motor by the motor shaft or hood. To avoid condensation inside the motor, do not unpack until the motor has reached room temperature. (Room temperature is the temperature of the room in which it will be installed). The packing provides insulation from temperature changes during transportation. A spreader bar should be used to lift the motor by the cast lifting lugs located on the motor frame. If the motor must be mounted to a plate with the driven equipment such as pump, compressor, etc., it may not be possible to lift the motor alone. For this case, the assembly should be lifted by a sling around the mounting base. The entire assembly can be lifted as an assembly for installation. Do not lift the assembly using the motor lugs or eye bolts provided. Lugs or eye bolts are designed to lift motor only. If the load is unbalanced (as with couplings or additional attachments) additional slings or other means must be used to prevent tipping. In any event, the load must be secure before lifting. If the load is unbalanced (as with couplings or additional attachments) additional slings or other means must be used to prevent tipping. In any event, the load must be secure before lifting.

Installation should conform to the Electrical Installation Code including Article 7.3 (for motors of Groups I and II) and PB 05-618-03, PB 03-553-03 (for motors of Group I), as well as GOST R IEC 60079-0-2007. When other devices are coupled to the motor shaft, be sure to install protective devices to prevent future accidents. Some protective devices include coupling, belt guard, chain guard, shaft covers, etc. These protect against accidental contact with moving parts. Machinery that is accessible to personnel should provide further protection in the form of guard rails, screening, warning signs, etc.

It is important that motors be installed in locations that are compatible with motor enclosure and ambient conditions. Improper selection of the motor enclosure and ambient conditions can lead to reduced operating life of the motor. Proper ventilation for the motor must be provided. Obstructed airflow can lead to reduction of motor life.

### Mounting

#### Location

The motor should be installed in a location compatible with the motor enclosure and specific ambient. To allow adequate air flow, the following clearances in Table 2-1 must be maintained between the motor and any obstruction:

**Table 2-1 Enclosure Clearance**

<b>TEFC / TENV (IC0141) Enclosures</b>	
Fan Cover Air Intake	180 - 210T Frame 1" (25mm)
Fan Cover Air Intake	250 - 449T Frame 4" (100mm)
	IEC 112 - 132 1" (25mm)
	IEC 160 - 280 4" (100mm)
Exhaust	Envelope equal to the P Dimension on the motor dimension sheet
<b>OPEN/Protected Enclosures</b>	
Bracket Intake	Same as TEFC
Frame Exhaust	Exhaust out the sides envelope A minimum of the P dimension plus 2" (50mm) Exhaust out the end same as intake.

The motor must be securely installed to a rigid foundation or mounting surface to minimize vibration and maintain alignment between the motor and shaft load. Failure to provide a proper mounting surface may cause vibration, misalignment and bearing damage.

Foundation caps and sole plates are designed to act as spacers for the equipment they support. If these devices are used, be sure that they are evenly supported by the foundation or mounting surface.

When installation is complete and accurate alignment of the motor and load is accomplished, the base should be grouted to the foundation to maintain this alignment.

The standard motor base is designed for horizontal or vertical mounting. Adjustable or sliding rails are designed for horizontal mounting only. Consult your Baldor distributor or authorized Baldor Service Center for further information.



## Frame Mounting Holes

Some motors have standardized frames containing 6 or 8 mounting holes. 6 hole frames are not suitable for field reversal of mounting from F-1 to F-2, etc. Figure 2-1 indicates the proper mounting holes to use.

**Figure 2-1 6 & 8 Hole Motor Frame Mounting**

For short frame designations 182, 213, 254, 284, 324, 364, 404, 444 (NEMA)

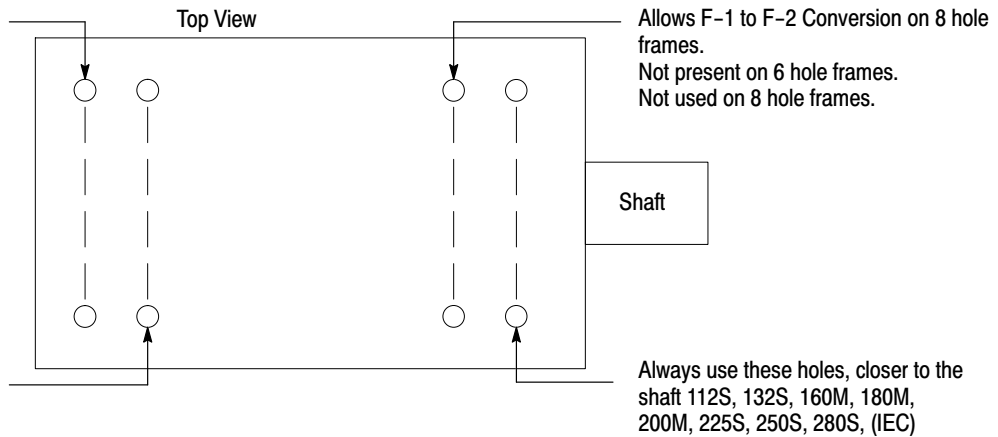

For long frame designations 184, 215, 256, 286, 326, 365, 405, 445 (NEMA)  
(IEC) 112M, 132M, 160L, 200L, 225M, 250M, 280M

**Caution:** Do not lift the motor and its driven load by the motor lifting hardware. The motor lifting hardware is adequate for lifting only the motor. Disconnect the load (gears, pumps, compressors, or other driven equipment) from the motor shaft before lifting the motor.

In the case of assemblies on a common base, any lifting means provided on the motor should not be used to lift the assembly and base but, rather, the assembly should be lifted by a sling around the base or by other lifting means provided on the base. Assure lifting in the direction intended in the design of the lifting means. Likewise, precautions should be taken to prevent hazardous overloads due to deceleration, acceleration or shock forces.

### Alignment

Accurate alignment of the motor with the driven equipment is extremely important. The pulley, sprocket, or gear used in the drive should be located on the shaft as close to the shaft shoulder as possible. It is recommended to heat the pulley, sprocket, or gear before installing on the motor shaft. Forcibly driving a unit on the motor shaft will damage the bearings.

#### 1. Direct Coupling

For direct drive, use flexible couplings if possible. Consult the drive or equipment manufacturer for more information. Mechanical vibration and roughness during operation may indicate poor alignment. Use dial indicators to check alignment. The space between coupling hubs should be maintained as recommended by the coupling manufacturer.

#### 2. End-Play Adjustment

The axial position of the motor frame with respect to its load is also extremely important. The standard motor bearings are not designed for excessive external axial thrust loads. Improper adjustment will cause failure.

#### 3. Pulley Ratio

The best practice is to not exceed an 8:1 pulley ratio.

**Caution:** Do not over tension belts. Excess tension may damage the motor or driven equipment.

#### 4. Belt Drive

Align sheaves carefully to minimize belt wear and axial bearing loads (see End-Play Adjustment). Belt tension should be sufficient to prevent belt slippage at rated speed and load. However, belt slippage may occur during starting.

**Doweling & Bolting** After proper alignment is verified, dowel pins should be inserted through the motor feet into the foundation. This will maintain the correct motor position should motor removal be required. (Baldor•Reliance motors are designed for doweling.)

1. Drill dowel holes in diagonally opposite motor feet in the locations provided.
2. Drill corresponding holes in the foundation.
3. Ream all holes.
4. Install proper fitting dowels.
5. Mounting bolts must be carefully tightened to prevent changes in alignment. Use a flat washer and lock washer under each nut or bolt head to hold the motor feet secure. Flanged nuts or bolts may be used as an alternative to washers.

**WARNING:** Guards must be installed for rotating parts such as couplings, pulleys, external fans, and unused shaft extensions, should be permanently guarded to prevent accidental contact by personnel. Accidental contact with body parts or clothing can cause serious or fatal injury.

**Guarding** Guards must be installed for rotating parts such as couplings, pulleys, external fans, and unused shaft extensions. This is particularly important where the parts have surface irregularities such as keys, key ways or set screws. Some satisfactory methods of guarding are:

1. Covering the machine and associated rotating parts with structural or decorative parts of the driven equipment.
2. Providing covers for the rotating parts. Covers should be sufficiently rigid to maintain adequate guarding during normal service.

**Connection of AC Power Supply**

Motors with flying lead construction must be properly terminated and insulated. Connect the motor leads as shown on the connection diagram located on the name plate or inside the cover on the conduit box. Be sure the following guidelines are met:

1. AC power is within  $\pm 10\%$  of rated voltage with rated frequency. (See motor name plate for ratings).  
**OR**
2. AC power is within  $\pm 5\%$  of rated frequency with rated voltage.  
**OR**
3. A combined variation in voltage and frequency of  $\pm 10\%$  (sum of absolute values) of rated values, provided the frequency variation does not exceed  $\pm 5\%$  of rated frequency.

Performance within these voltage and frequency variations are shown in Figure 2-2.

**Figure 2-2 Typical Motor Performance VS Voltage Variations**

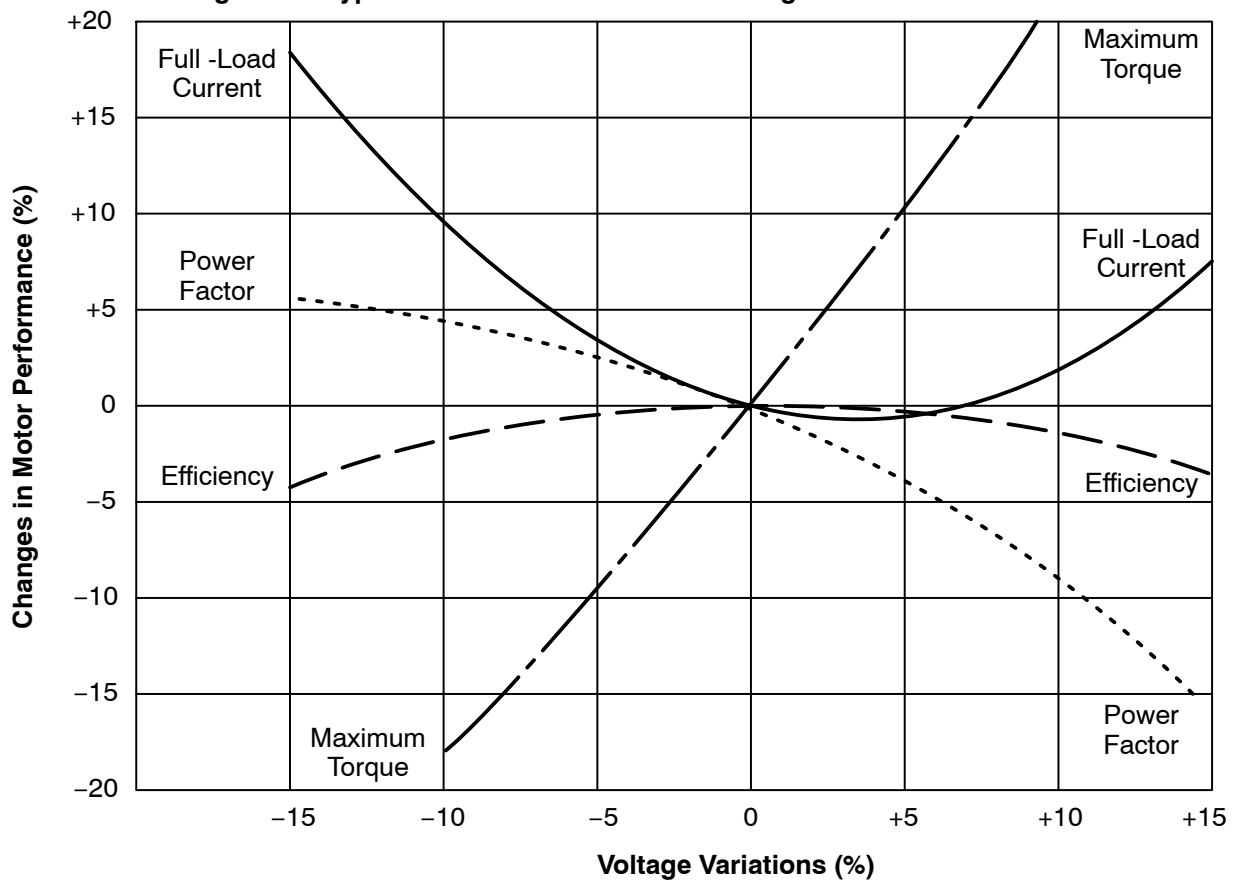

---

## Connection of Additional Devices

**Caution:** The space heaters are designed to operate at or below the maximum surface temperature stated on the nameplate. If the marked ambient and/or voltage are exceeded this maximum surface temperature can be exceeded and can damage the motor windings. If applied in a division 2 or zone 2 environment this excessive temperature may cause ignition of hazardous materials.

Motors are provided with mounted heaters. Leads for each heater are labeled H1 & H2. Like numbers should be tied together, refer to Figure 2-3.

**Figure 2-3 Accessory Connections**

### HEATERS

H1  H2

H1  H2

One heater is installed in each end of motor.  
Leads for each heater are labeled H1 & H2.  
(Like numbers should be tied together).

---

### THERMISTORS

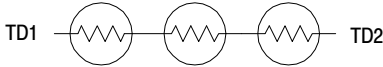

Three thermistors are installed in windings and tied in series.  
Leads are labeled TD1 & TD2.

---

### WINDING RTDS



Winding RTDs are installed in windings (2) per phase.  
Each set of leads is labeled 1TD1, 1TD2, 1TD3, 2TD1, 2TD2, 2TD3 etc.

---

### BEARING RTD



- \* One bearing RTD is installed in Drive endplate (PUEP), leads are labeled RTDDE.
- \* One bearing RTD is installed in Opposite Drive endplate (FREP), leads are labeled RTDODE.
- \* Note RTD may have 2-Red/1-White leads; or 2-White/1-Red Lead.

## Thermal Limiting

Thermal limiting devices are temperature sensing control components installed inside the motor to limit the internal temperature of the motor frame by interrupting the circuit of the holding coil of the magnetic switch or contactor. They are required for most Division 1 and Zone 1 applications. For Division 2 or Zone 2 applications, motors should be selected that preclude running temperatures from exceeding the ignition temperatures for the designated hazardous material. In Division 2 or Zone 2 classified locations, thermal limiting devices should only be used for winding protection and not considered for limiting all internal motor temperatures to specific ignition temperatures.

## Equipotential Bonding and Shaft Current Reduction

Larger motors (ie WP construction) may require proper bonding between motor enclosures and covers to avoid the risk of stray currents during start up. Fastening methods and bonding straps must not be modified. Bearing currents can exist in some motors for both line-fed and inverter-fed applications. Larger line-fed motors may require at least one insulated bearing to prevent a flow of current through the bearings. Do not defeat such insulation whether the motor is line-fed or inverter-fed applications. Inverter-fed motors may require additional bearing insulation or even a shaft brush. Do not defeat such features. When the motor and the coupled load are not on a common conductive baseplate, it may also be necessary to electrically bond together the stationary parts of the motor and the coupled equipment.

## Options of Rotation Control (Direction and Speed)

All three phase motors are reversible. To reverse the direction of rotation, disconnect and lock out power and interchange any two of the three line leads for three phase motors. For single phase motors, check the connection diagram to determine if the motor is reversible and follow the connection instructions for lead numbers to be interchanged. Not all single phase motors are reversible.

Adjustable Frequency Power Inverters used to supply adjustable frequency power to induction motors produce wave forms with lower order harmonics with voltage spikes superimposed. Turn-to-turn, phase-to-phase, and ground insulation of stator windings are subject to the resulting dielectric stresses. Suitable precautions should be taken in the design of these drive systems to minimize the magnitude of these voltage spikes. Consult the drive instructions for maximum acceptable motor lead lengths, and proper grounding.

Note: Main power leads for CE Marked Motors may be marked U,V,W – for standard configurations, please refer to “Connection Diagrams”.

## Connection Diagrams AC Motor Connection Diagram

### IEC VERSUS NEMA LEAD MARKING

EXAMPLE COMPARISONS OF IEC AND NEMA LEADING MARKINGS FOR COMMON CONNECTION TYPES ARE SHOWN BELOW.

#### SINGLE PHASE MOTORS

##### SINGLE VOLTAGE NON REVERSIBLE



##### SINGLE VOLTAGE REVERSIBLE

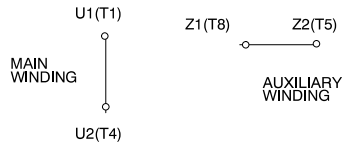

##### DUAL VOLTAGE REVERSIBLE

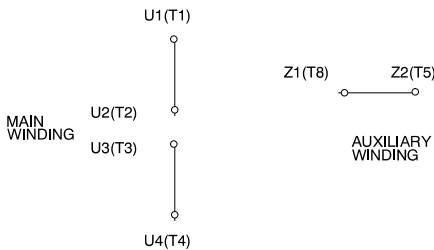

## AC Motor Connection Diagram

### THREE PHASE

FOR SINGLE WINDING 3 PHASE MOTORS, LEAD MARKINGS CAN BE DIRECTLY TRANSLATED BETWEEN IEC AND NEMA DESIGNATIONS. FOR THESE MOTORS, THE LEAD MARKINGS ARE EQUIVALENT AS FOLLOWS:

U1=T1    U2=T4    U5=T7    U6=T10  
V1=T2    V2=T5    V5=T8    V6=T11  
W1=T3    W2=T6    W5=T9    W6=T12

EXAMPLES OF COMMON CONNECTIONS ARE GIVEN BELOW.

#### THREE LEADS

##### WYE CONNECT

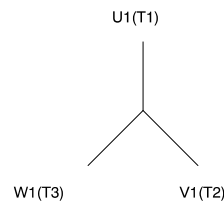

##### WIRING DIAGRAM

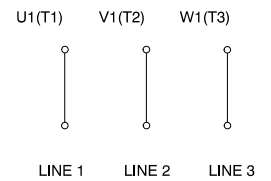

##### DELTA CONNECT

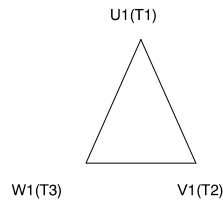

##### WIRING DIAGRAM

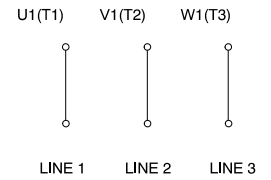

## AC Motor Connection Diagram

### SIX LEADS

#### DELTA-WYE CONNECT

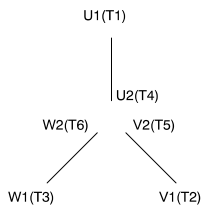

#### DUAL VOLTAGE-HIGH TO LOW VOLTAGE RATIO 1.73:1

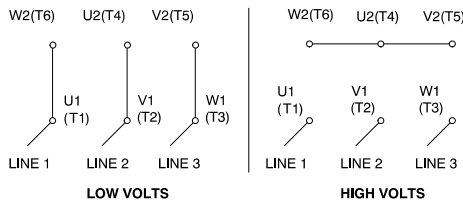

#### WYE-DELTA CONNECT

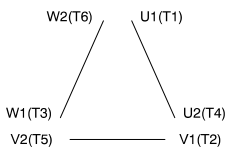

#### WYE START-DELTA RUN SINGLE VOLTAGE

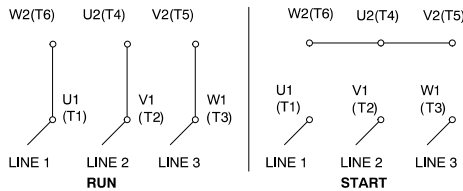

## AC Motor Connection Diagram

### NINE LEADS

#### DUAL VOLTAGE-HIGH TO LOW VOLTAGE RATIO 2:1

##### WYE CONNECT

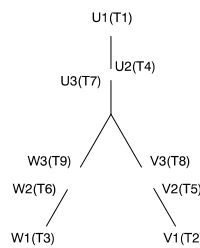

##### WIRING DIAGRAM

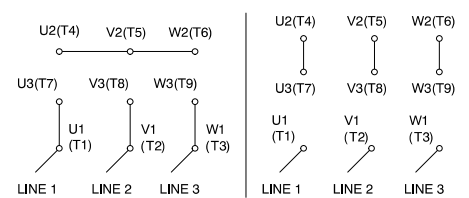

##### DELTA CONNECT

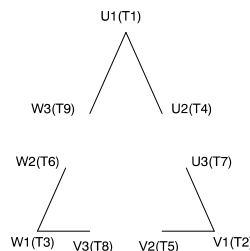

##### WIRING DIAGRAM

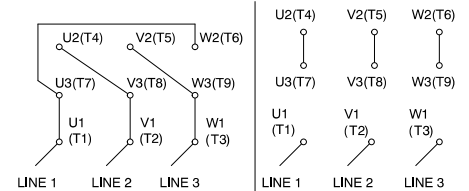

## Connection Diagrams Continued

### AC Motor Connection Diagram

TWELVE LEADS

DUAL VOLTAGE WYE START - DELTA - RUN

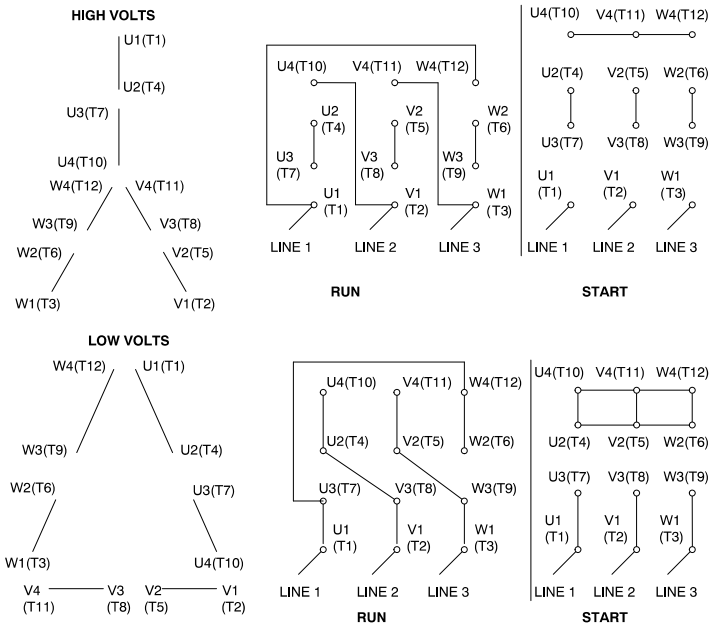

### AC Motor Connection Diagram

SINGLE WINDING MULTI-SPEEDS CONSTANT TORQUE

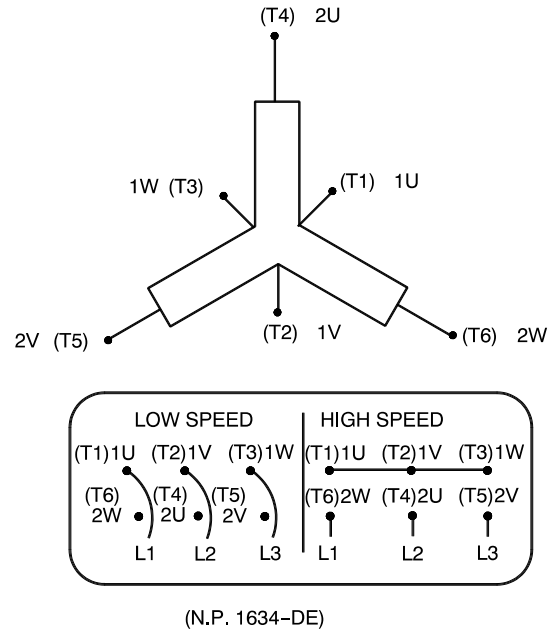

### AC Motor Connection Diagram

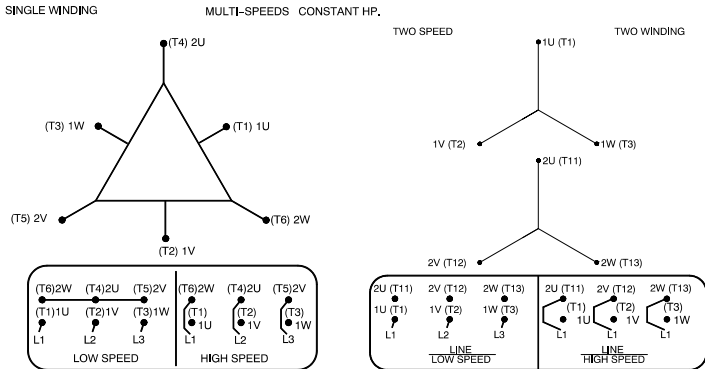

### DC Motor Connection Diagram

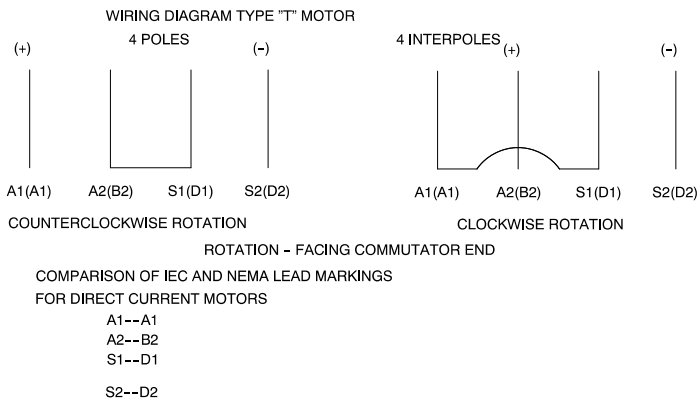

MOTOR WINDING THERMOSTATS		
CONTACTS _____ @ _____ °C		
FIGURE NUMBER _____		
CONTACT RATING		
VOLTS	CONTINUOUS AMPERES	INRUSH AMPERES
110 - 120	3.0	30
220 - 240	1.5	15
440 - 480	0.75	7.5
550 - 600	0.60	6.0

THERMOSTATS	
NORMALLY CLOSED	NORMALLY OPEN
<b>FIGURE 1</b> 	<b>FIGURE 4</b> 
<b>FIGURE 2</b> 	<b>FIGURE 5</b> 
<b>FIGURE 3</b> 	<b>FIGURE 6</b> 

---

## **Lubrication Procedure**

**Initial Lubrication** Baldor•Reliance motors are shipped from the factory with the bearings properly packed with grease and ready to operate. Where the unit has been subjected to extended storage (6 months or more) the bearings should be relubricated (regreasable type) prior to starting. When motors are equipped for oil mist lubrication refer to the instruction manual for installation, operation, and maintenance of oil mist lubrication systems.

### **Start-up and Commencement Of Operation of Electrical Motors**

Motor operation should conform to the Electrical Installation Code including Article 7.3, PB 08-624-03, PB 09-540-03, PTE (for motors of Groups II), PUE, PTE (for motors of Groups III), and PB 05-618-03, PB 03-553-03 (for motors of Groups I).

**First Time Start Up** Be sure that all power to motor and accessories is off. Be sure the motor shaft is disconnected from the load and will not cause mechanical rotation of the motor shaft.

1. Make sure that the mechanical installation is secure. All bolts and nuts are tightened etc.
2. If motor has been in storage or idle for some time, check winding insulation integrity.
3. Inspect all electrical connections for proper termination, clearance, mechanical strength and electrical continuity.
4. Be sure all shipping materials and braces (if used) are removed from motor shaft.
5. Manually rotate the motor shaft to ensure that it rotates freely.
6. Replace all panels and covers that were removed during installation.
7. Momentarily apply power and check the direction of rotation of the motor shaft.
8. If motor rotation is wrong, be sure power is off and change the motor lead connections. Verify rotation direction before you continue.
9. Start the motor and ensure operation is smooth without excessive vibration or noise. If so, run the motor for 1 hour with no load connected.
10. After 1 hour of operation, disconnect power and connect the load to the motor shaft. Verify all coupling guards and protective devices are installed. Ensure motor is properly ventilated.
11. If motor is totally enclosed fan-cooled or non-ventilated it is recommended that condensation drain plugs, if present, be removed. These are located in the lower portion of the end-shields. Totally enclosed fan-cooled "XT" motors are normally equipped with automatic drains which may be left in place as received.

**Coupled Start Up** This procedure assumes a coupled start up. Also, that the first time start up procedure was successful.

1. Check the coupling and ensure that all guards and protective devices are installed.
2. Check that the coupling is properly aligned and not binding.
3. The first coupled start up should be with no load. Apply power and verify that the load is not transmitting excessive vibration back to the motor through the coupling or the foundation. Vibration should be at an acceptable level.
4. Run for approximately 1 hour with the driven equipment in an unloaded condition. The equipment can now be loaded and operated within specified limits. Do not exceed the name plate ratings for amperes for steady continuous loads.

**Jogging and Repeated Starts** Repeated starts and/or jogs of induction motors generally reduce the life of the motor winding insulation. A much greater amount of heat is produced by each acceleration or jog than by the same motor under full load. If it is necessary to repeatedly start or jog the motor, it is advisable to check the application with your local Baldor distributor or Baldor Service Center.

**Heating** - Duty rating and maximum ambient temperature are stated on the motor name plate. Do not exceed these values. If there is any question regarding safe operation, contact your local Baldor distributor or Baldor Service Center.

#### **Thermal Limiting**

Thermal limiting devices are temperature sensing control components installed inside the motor to limit the internal temperature of the motor frame by interrupting the circuit of the holding coil of the magnetic switch or contactor. They are required for most Division 1 and Zone 1 applications. For Division 2 or Zone 2 applications, motors should be selected that preclude running temperatures from exceeding the ignition temperatures for the designated hazardous material. In Division 2 or Zone 2 classified locations, thermal limiting devices should only be used for winding protection and not considered for limiting all internal motor temperatures to specific ignition temperatures.

---

## **Repair**

Repair of hazardous certified motors requires additional information, skill, and care. It is the customer's responsibility to select service shops with proper qualifications to repair hazardous location motors. Contact the manufacture for additional repair details. Use only original manufacturer's parts.

## Section 3 Maintenance & Troubleshooting

---

**WARNING:** UL and EX Listed motors must only be serviced by UL or EX Approved Authorized Baldor Service Centers if these motors are to be returned to a hazardous and/or explosive atmosphere.

**General Inspection** Inspect the motor at regular intervals, approximately every 500 hours of operation or every 3 months, whichever occurs first. Keep the motor clean and the ventilation openings clear. The following steps should be performed at each inspection:

**WARNING:** Do not touch electrical connections before you first ensure that power has been disconnected. Electrical shock can cause serious or fatal injury. Only qualified personnel should attempt the installation, operation and maintenance of this equipment.

1. Check that the motor is clean. Check that the interior and exterior of the motor is free of dirt, oil, grease, water, etc. Oily vapor, paper pulp, textile lint, etc. can accumulate and block motor ventilation. If the motor is not properly ventilated, overheating can occur and cause early motor failure.
2. Perform a dielectric with stand test periodically to ensure that the integrity of the winding insulation has been maintained. Record the readings. Immediately investigate any significant decrease in insulation resistance.
3. Check all electrical connectors to be sure that they are tight.

**Relubrication & Bearings** Bearing grease will lose its lubricating ability over time, not suddenly. The lubricating ability of a grease (over time) depends primarily on the type of grease, the size of the bearing, the speed at which the bearing operates and the severity of the operating conditions. Good results can be obtained if the following recommendations are used in your maintenance program.

**Type of Grease** A high grade ball or roller bearing grease should be used. Recommended grease for standard service conditions is **Mobil Polyrex EM**. Do not mix greases unless compatibility has been checked and verified.

### Ball Bearing Motors

Operating Temperature  $-25^{\circ}\text{C}$  ( $-15^{\circ}\text{F}$ ) to  $50^{\circ}\text{C}$  ( $120^{\circ}\text{F}$ )

Mobil	POLYREX EM (Standard on Baldor motors)
EXXON	UNIREX N2
EXXON	BEACON 325
CHEVRON OIL	SRI NO. 2 ( Compatible with Polyrex EM )
CHEVRON OIL	BLACK PEARL
TEXACO, INC.	PREMIUM RB
TEXACO, INC.	POLYSTAR
AMOCO	RYKON # 2
PENNZOIL	PENNZLUBE EM-2
DARMEX	DARMEX 707
DARMEX	DARMEX 711
PETRO-CANADA	PEERLESS LLG
SHELL OIL	DOLIUM BRB

Minimum Starting Temperature  $-60^{\circ}\text{C}$  ( $-76^{\circ}\text{F}$ )

SHELL OIL CO.	AEROSHELL 7 (Standard on Baldor motors)
MOBIL	MOBIL 28
MOBIL	MOBILITH SHC 100 (Low Temperature - Arctic Duty)

### Roller Bearing Motors

Operating Temperature  $-25^{\circ}\text{C}$  ( $-15^{\circ}\text{F}$ ) to  $50^{\circ}\text{C}$  ( $120^{\circ}\text{F}$ )

TEXACO, INC.	PREMIUM RB
MOBIL	MOBILITH SHC 220 (Standard on Baldor motors)
CHEVRON OIL	BLACK PEARL



**Relubrication Intervals** Recommended relubrication intervals are shown in Table 3-1. It is important to realize that the recommended intervals of Table 3-1 are based on average use.

Refer to additional information contained in Tables 3-2, 3-3 and 3-4.

**Table 3-1 Relubrication Intervals \***

NEMA / (IEC) Frame Size	Rated Speed - RPM					
	10000	6000	3600	1800	1200	900
Up to 210 incl. (132)	**	2700 Hrs.	5500 Hrs.	12000 Hrs.	18000 Hrs.	22000 Hrs.
Over 210 to 280 incl. (180)		**	3600 Hrs.	9500 Hrs.	15000 Hrs.	18000 Hrs.
Over 280 to 360 incl. (225)		**	* 2200 Hrs.	7400 Hrs.	12000 Hrs.	15000 Hrs.
Over 360 to 449 incl. (315)		**	*2200 Hrs.	3500 Hrs.	7400 Hrs.	10500 Hrs.

\* Relubrication intervals are for ball bearings.

For vertically mounted motors and roller bearings, divide the relubrication interval by 2.

\*\* For motors operating at speeds greater than 3600 RPM, contact Baldor for relubrication recommendations.

**Table 3-2 Service Conditions**

Severity of Service	Hours per day of Operation	Ambient Temperature Maximum	Atmospheric Contamination
Standard	8	40° C	Clean, Little Corrosion
Severe	16 Plus	50° C	Moderate dirt, Corrosion
Extreme	16 Plus	>50° C* or Class H Insulation	Severe dirt, Abrasive dust, Corrosion, Heavy Shock or Vibration
Low Temperature		<-29° C **	

\* Special high temperature grease is recommended (Dow Corning DC44). Note that Dow Corning DC44 grease does not mix with other grease types. Thoroughly clean bearing & cavity before adding grease.

\*\* Special low temperature grease is recommended (Aeroshell 7).

**Table 3-3 Relubrication Interval Multiplier**

Severity of Service	Multiplier
Standard	1.0
Severe	0.5
Extreme	0.1
Low Temperature	1.0

Some motor designs use different bearings on each motor end. This is normally indicated on the motor nameplate. In this case, the larger bearing is installed on the motor Drive endplate. For best relubrication results, only use the appropriate amount of grease for each bearing size (not the same for both).

**Table 3-4 Bearings Sizes and Types**

Frame Size NEMA (IEC)	Bearing Description (These are the "Large" bearings (Shaft End) in each frame size)			
	Bearing	Weight of Grease to add * oz (Grams)	Volume of grease to be added	
			in <sup>3</sup>	teaspoon
56 to 140 (90)	6203	0.08 (2.4)	0.15	0.5
140 (90)	6205	0.15 (3.9)	0.2	0.8
180 (100–112)	6206	0.19 (5.0)	0.3	1.0
210 (132)	6307	0.30 (8.4)	0.6	2.0
250 (160)	6309	0.47 (12.5)	0.7	2.5
280 (180)	6311	0.61 (17)	1.2	3.9
320 (200)	6312	0.76 (20.1)	1.2	4.0
360 (225)	6313	0.81 (23)	1.5	5.2
400 (250)	6316	1.25 (33)	2.0	6.6
440 (280)	6318	1.52 (40)	2.5	8.2
440 (280)	6319	2.12 (60)	4.1	13.4
5000 to 5800 (315–355)	6328	4.70 (130)	9.2	30.0
5000 to 5800 (315–355)	NU328	4.70 (130)	9.2	30.0
360 to 449 (225–280)	NU319	2.12 (60)	4.1	13.4

\* Weight in grams = .005 DB of grease to be added

Note: Not all bearing sizes are listed.

For intermediate bearing sizes, use the grease volume for the next larger size bearing.

**Caution:** To avoid damage to motor bearings, grease must be kept free of dirt. For an extremely dirty environment, contact your Baldor distributor or an authorized Baldor Service Center for additional information.

**Relubrication Procedure** Be sure that the grease you are adding to the motor is compatible with the grease already in the motor. Consult your Baldor distributor or an authorized service center if a grease other than the recommended type is to be used.

**Caution:** Do not over-lubricate motor as this may cause premature bearing failure.

**With Grease Outlet Plug**

1. With the motor stopped, clean all grease fittings with a clean cloth.
2. Remove grease outlet plug.

**Caution:** Over-lubricating can cause excessive bearing temperatures, premature lubrication breakdown and bearing failure.

3. Add the recommended amount of grease.
4. Operate the motor for 15 minutes with grease plug removed.  
This allows excess grease to purge.
5. Re-install grease outlet plug.

**Without Grease Provisions**

**Note:** Only a Baldor authorized and UL or CSA certified service center can disassemble a UL/CSA listed explosion proof motor to maintain it's UL/CSA listing.

1. Disassemble the motor.
2. Add recommended amount of grease to bearing and bearing cavity. (Bearing should be about 1/3 full of grease and outboard bearing cavity should be about 1/2 full of grease.)
3. Assemble the motor.

---

### Sample Relubrication Determination

Assume - NEMA 286T (IEC 180), 1750 RPM motor driving an exhaust fan in an ambient temperature of 43° C and the atmosphere is moderately corrosive.

1. Table 3-1 list 9500 hours for standard conditions.
2. Table 3-2 classifies severity of service as "Severe".
3. Table 3-4 shows that 1.2 in<sup>3</sup> or 3.9 teaspoon of grease is to be added.

Note: Smaller bearings in size category may require reduced amounts of grease.

**Table 3-5 Troubleshooting Chart**

Symptom	Possible Causes	Possible Solutions
Motor will not start	Usually caused by line trouble, such as, single phasing at the starter.	Check source of power. Check overloads, fuses, controls, etc.
Excessive humming	High Voltage.	Check input line connections.
	Eccentric air gap.	Have motor serviced at local Baldor service center.
Motor Over Heating	Overload. Compare actual amps (measured) with nameplate rating.	Locate and remove source of excessive friction in motor or load. Reduce load or replace with motor of greater capacity.
	Single Phasing.	Check current at all phases (should be approximately equal) to isolate and correct the problem.
	Improper ventilation.	Check external cooling fan to be sure air is moving properly across cooling fins. Excessive dirt build-up on motor. Clean motor.
	Unbalanced voltage.	Check voltage at all phases (should be approximately equal) to isolate and correct the problem.
	Rotor rubbing on stator.	Check air gap clearance and bearings. Tighten "Thru Bolts".
	Over voltage or under voltage.	Check input voltage at each phase to motor.
	Open stator winding.	Check stator resistance at all three phases for balance.
	Grounded winding.	Perform dielectric test and repair as required.
	Improper connections.	Inspect all electrical connections for proper termination, clearance, mechanical strength and electrical continuity. Refer to motor lead connection diagram.
	Bearing Over Heating	Misalignment.
Excessive belt tension.		Reduce belt tension to proper point for load.
Excessive end thrust.		Reduce the end thrust from driven machine.
Excessive grease in bearing.		Remove grease until cavity is approximately $\frac{3}{4}$ filled.
Insufficient grease in bearing.		Add grease until cavity is approximately $\frac{3}{4}$ filled.
Dirt in bearing.		Clean bearing cavity and bearing. Repack with correct grease until cavity is approximately $\frac{3}{4}$ filled.
Vibration	Misalignment.	Check and align motor and driven equipment.
	Rubbing between rotating parts and stationary parts.	Isolate and eliminate cause of rubbing.
	Rotor out of balance.	Have rotor balance checked and repaired at your Baldor Service Center.
	Resonance.	Tune system or contact your Baldor Service Center for assistance.
Noise	Foreign material in air gap or ventilation openings.	Remove rotor and foreign material. Reinstall rotor. Check insulation integrity. Clean ventilation openings.
Growling or whining	Bad bearing.	Replace bearing. Clean all grease from cavity and new bearing. Repack with correct grease until cavity is approximately $\frac{3}{4}$ filled.

### Suggested bearing and winding RTD setting guidelines for Non-Hazardous Locations ONLY

Most large frame AC Baldor motors with a 1.15 service factor are designed to operate below a Class B (80°C) temperature rise at rated load and are built with a Class H winding insulation system. Based on this low temperature rise, RTD (Resistance Temperature Detectors) settings for Class B rise should be used as a starting point. Some motors with 1.0 service factor have Class F temperature rise.

The following tables show the suggested alarm and trip settings for RTDs. Proper bearing and winding RTD alarm and trip settings should be selected based on these tables unless otherwise specified for specific applications.

If the driven load is found to operate well below the initial temperature settings under normal conditions, the alarm and trip settings may be reduced so that an abnormal machine load will be identified.

The temperature limits are based on the installation of the winding RTDs imbedded in the winding as specified by NEMA. Bearing RTDs should be installed so they are in contact with the outer race on ball or roller bearings or in direct contact with the sleeve bearing shell.

#### Winding RTDs – Temperature Limit In °C (40°C Maximum Ambient)

Motor Load	Class B Temp Rise ≤ 80°C (Typical Design)		Class F Temp Rise ≤ 105°C		Class H Temp Rise ≤ 125°C	
	Alarm	Trip	Alarm	Trip	Alarm	Trip
≤ Rated Load	130	140	155	165	175	185
Rated Load to 1.15 S.F.	140	150	160	165	180	185

Note: • Winding RTDs are factory production installed, not from Mod-Express.  
• When Class H temperatures are used, consider bearing temperatures and relubrication requirements.

#### Bearing RTDs – Temperature Limit In °C (40°C Maximum Ambient)

Bearing Type Oil or Grease	Anti-Friction		Sleeve	
	Alarm	Trip	Alarm	Trip
Standard*	95	100	85	95
High Temperature**	110	115	105	110

Note: \* Bearing temperature limits are for standard design motors operating at Class B temperature rise.  
\*\* High temperature lubricants include some special synthetic oils and greases.

Greases that may be substituted that are compatible with Polyrex EM (but considered as “standard” lubricants) include the following:

- Texaco Polystar
- Mobilith SHC-100
- Darmex 707
- Rykon Premium #2
- Pennzoil Pennzlube EM-2
- Darmex 711
- Chevron SRI #2
- Chevron Black Pearl
- Petro-Canada Peerless LLG

See the motor nameplate for replacement grease or oil recommendation.  
Contact Baldor application engineering for special lubricants or further clarifications.

Figure A-1

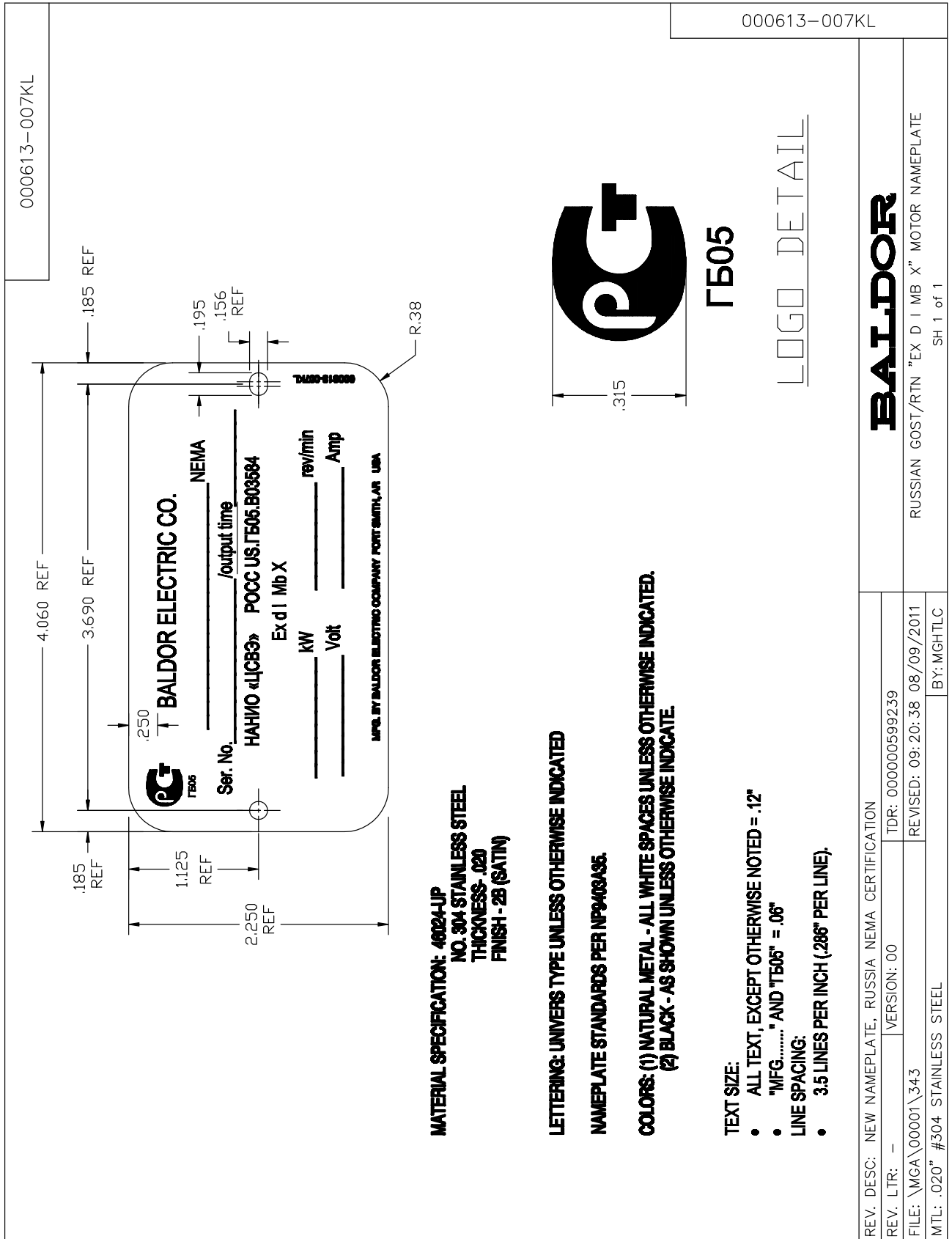

Figure A-2

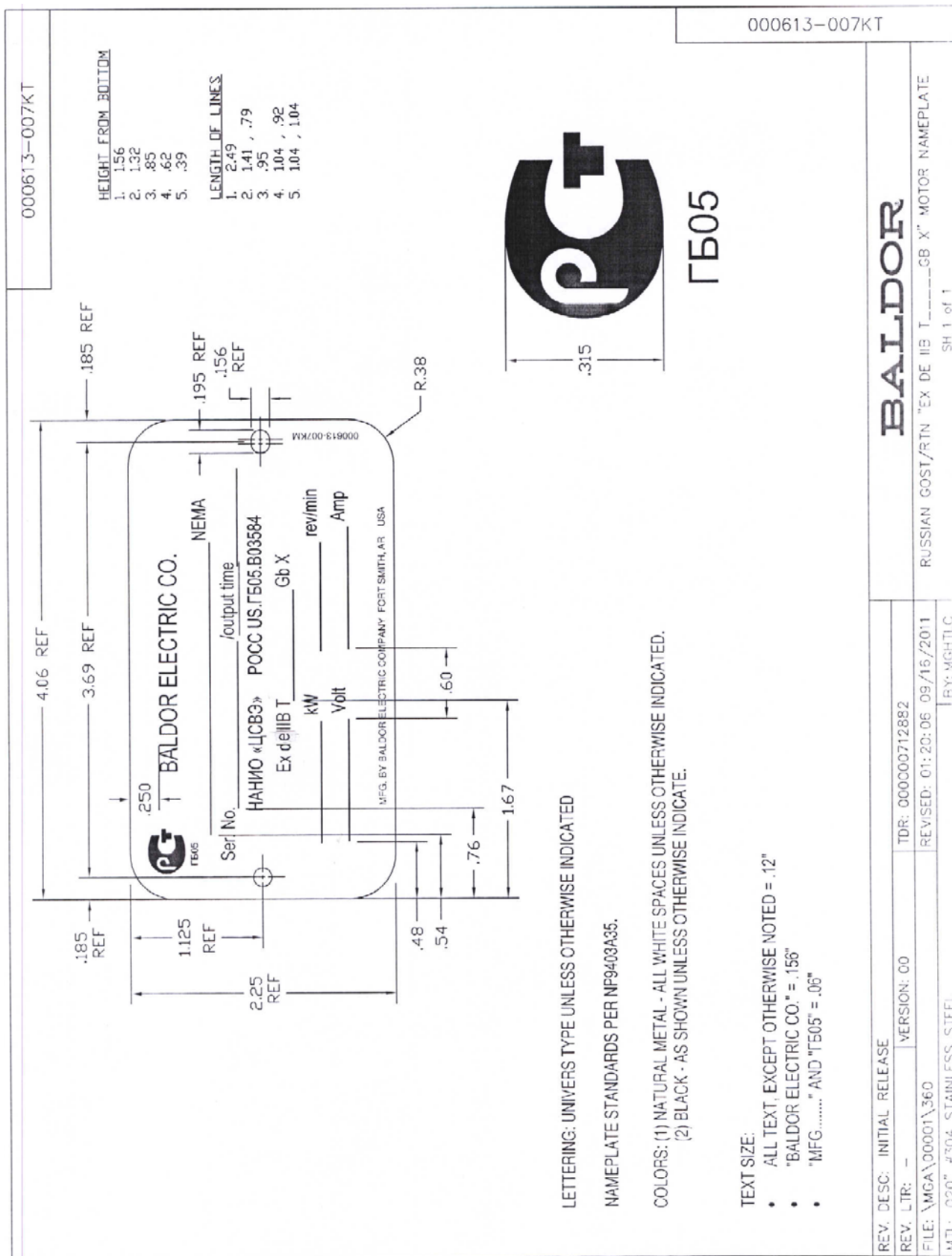

Figure A-3

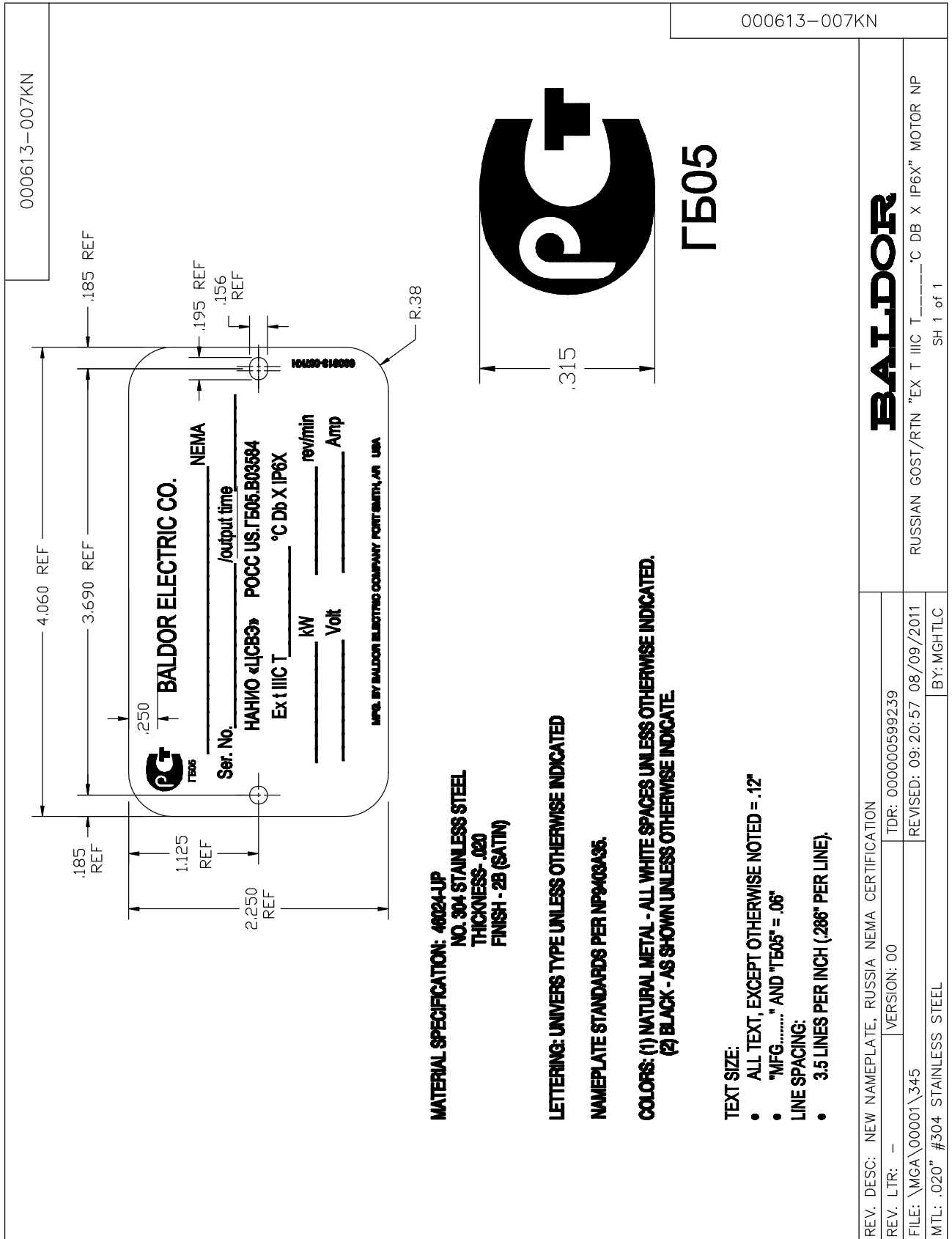
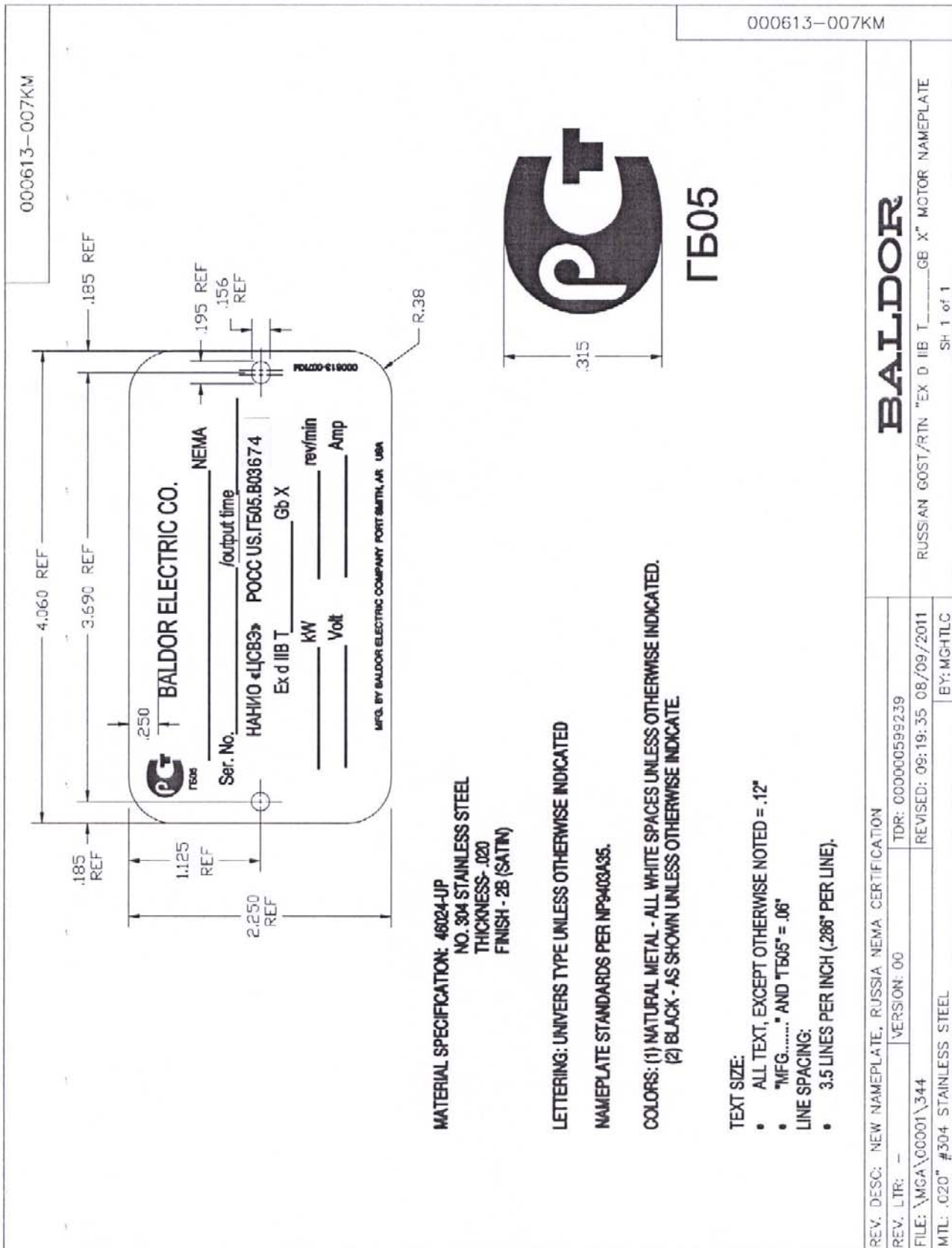



Figure A-4



**FLAMEPROOF ENCLOSURE 'd'**

GROUP I / IIB PER 60079-0 AND IEC 60079-1

SIRA 09ATEX1037X  
IECEx SIR 09.0011X

SIRA CERTIFICATE No's.

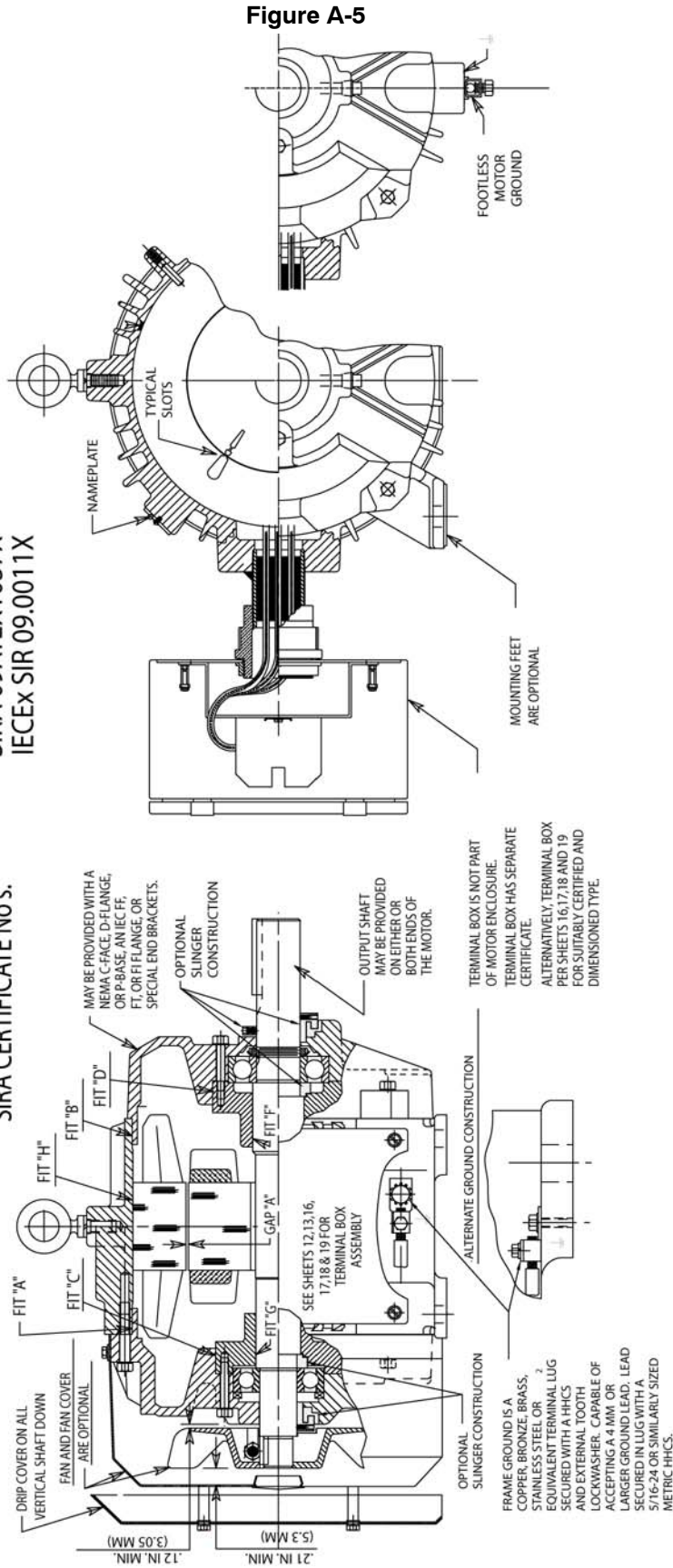







**BALDOR**  
A MEMBER OF THE ABB GROUP

**BALDOR ELECTRIC COMPANY**  
**P.O. Box 2400 Fort Smith, AR 72901-2400**  
**(479) 646-4711 Fax (479) 648-5792**  
**[www.baldor.com](http://www.baldor.com)**

© 2011 Baldor Electric Company  
MN430

All rights reserved. Printed in USA  
12/11